

Koyo[®]

Precision Ball & Roller Bearings for Machine Tools



JTEKT

JTEKT CORPORATION



Precision Ball & Roller Bearings for Machine Tools

CAT. NO. B2005E-1

Value & Technology



Catalog

Precision Ball & Roller Bearings for Machine Tools Preface

Thank you for your valuable support of **KOYO** products.

Nowadays, there is a pressing demand in the industrial world for sophisticating machine tools in all aspects.

Accordingly, ball & roller bearings for machine tools must be more compact and lightweight and exhibit such features as longer service life, higher performance, and higher reliability. This is made possible only through a wide range of high technologies.

Under these circumstances, we have decided to publish this revised version of the **KOYO** catalog, **Precision Ball & Roller Bearings for Machine Tools**.

In this catalog, we have enriched the contents and added new products.

We are confident that this catalog will be of help to the user in the design of machine tools and in the use of precision rolling bearings.

JTEKT continually offers the best technologies, quality, and services, through inspiration from the market and putting efforts into research and technical developments.

We hope that you will be as satisfied with our products and services as you have been in the past.

☆The contents of this catalog are subject to change without prior notice.
Every possible effort has been made to ensure that the data listed in this catalogue is correct.
However, we can not assume responsibility for any errors or omissions.

Reproduction of this catalog without JTEKT's permission is strictly prohibited.

CONTENTS

I. Precision Ball & Roller Bearings

Technical Descriptions

1. Types and structures of precision ball & roller bearings for machine tools	12
2. Selection of bearings	14
3. Selection of bearing types	15
4. Spindle bearing arrangements	16
5. Service life of bearings	
5.1 Rating life of bearings	18
5.2 Service life calculation of bearings	18
5.3 Dynamic equivalent loads	20
5.4 Basic static load rating and static equivalent load	23
5.5 Service life of greases	24
5.6 Permissible axial loads	24
6. Rigidity and preload of bearings	
6.1 Rigidity of bearings	25
6.2 Preload of bearings	25
7. Limiting speeds of bearings	30
8. Lubrication	
8.1 Grease lubrication	32
8.2 Oil lubrication	33
9. Designing peripheral parts of bearings	
9.1 Tolerances of shafts and housings	35
9.2 Limits of chamfer dimensions and fillet radii of shafts and housings	36
9.3 Spacers for oil / air lubrication	37
10. High Ability angular contact ball bearings	42
11. Ceramic bearings for machine tool spindles	45

Bearing Dimension Tables

1. Angular Contact Ball Bearings	
1.1 Types and features of angular contact ball bearings	53
1.2 Matched pair angular contact ball bearings	54
1.3 Composition of bearing numbers	55
1.4 Tolerance of bearings	56
1.5 Standard preloads for matched pair angular contact ball bearings	58
1.6 Axial load and displacement	60
(Bearing Dimension Tables)	66
2. Cylindrical Roller Bearings	
2.1 Types and features of cylindrical roller bearings	123
2.2 Composition of bearing numbers	123
2.3 Tolerance of cylindrical roller bearings	124
2.4 Radial internal clearances of cylindrical roller bearings	125
(Bearing Dimension Tables)	126
3. Angular Contact Ball Bearings for Axial Load	
3.1 Types and features of angular contact ball bearings for axial load	137
3.2 Composition of bearing numbers	138
3.3 Tolerance of angular contact ball bearings for axial load	139
3.4 Standard preloads for high-speed matched pair angular contact ball bearings	142
3.5 Axial load and displacement	143
(Bearing Dimension Tables)	146

4. Tapered Roller Bearings	
4.1 Types and features of tapered roller bearings	157
4.2 Composition of bearing numbers ...	157
4.3 Tolerance of tapered roller bearings	158
4.4 Axial load and displacement	159
(Bearing Dimension Tables)	160
5. Support Bearings and Support Bearing Units for Precision Ball Screws	
5.1 Structure and features	171
5.2 Composition of identification numbers	173
5.3 Tolerance of support bearings for precision ball screws	174
5.4 Axial load and displacement	174
(Bearing and Bearing Unit Dimension Tables)	176

II. Oil / Air Lubrication System

1. Oil / air lubricator	184
2. Air cleaning unit.....	188

III. Handling of Bearings

1. Handling and mounting of bearings...	192
---	-----

IV. Examples of Bearing Failures

1. Bearing failures, causes and countermeasures	204
---	-----

V. Supplementary Tables

1. Shaft tolerances.....	208
2. Housing bore tolerances	210
3. Numerical values for standard tolerance grades IT	212
4. Steel hardness conversion.....	213
5. SI units and conversion factors	214
6. Lubrication (discharge) intervals of the oil / air.....	219
7. Specification report.....	220



I . Precision Ball & Roller Bearings



I . Precision Ball & Roller Bearings

CONTENTS

Technical Descriptions

1. Types and structures of precision ball & roller bearings for machine tools	12
2. Selection of bearings	14
3. Selection of bearing types	15
4. Spindle bearing arrangements	16
5. Service life of bearings	
5.1 Rating life of bearings	18
5.2 Service life calculation of bearings	18
5.3 Dynamic equivalent loads	20
5.4 Basic static load rating and static equivalent load	23
5.5 Service life of greases	24
5.6 Permissible axial loads	24
6. Rigidity and preload of bearings	
6.1 Rigidity of bearings	25
6.2 Preload of bearings	25
7. Limiting speeds of bearings	30
8. Lubrication	
8.1 Grease lubrication	32
8.2 Oil lubrication	33
9. Designing peripheral parts of bearings	
9.1 Tolerances of shafts and housings	35
9.2 Limits of chamfer dimensions and fillet radii of shafts and housings...	36
9.3 Spacers for oil / air lubrication ...	37
10. High Ability angular contact ball bearings	42
11. Ceramic bearings for machine tool spindles	45



**Precision Ball & Roller
Bearings**

Technical Descriptions

1. Types and structures of precision ball & roller bearings for machine tools

Table 1. 1(1) Types and structures of precision ball & roller bearings for machine tools

1 Spindle bearings











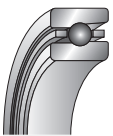







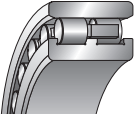

Bearing types	Cross-sections	Bearing series	Contact angles	Features and descriptions	Page No.	
 Angular contact ball bearings		Standard types	79C 70C 72C	15°	<ul style="list-style-type: none"> Some bearing series support contact angle of 40° (B). 	51
			70 72	30°		
		 High-speed types	79CPA 70CPA 72CPA	15°	<ul style="list-style-type: none"> Exhibits superb high-speed performance using an outer ring guided cage. Improvements in high-speed performance are made through the use of balls that have a smaller diameter than standard bearing balls. Also, a large number of balls contributes to higher rigidity. Rolling elements are available in steel and in ceramic. Consult JTEKT, as the HAR000 series can correspond to the non-contact seal. 	82
			HAR9C HAR0C	15°		
			HAR9CA HAR0CA	20°		
		 High-speed types	3NCHAC9C 3NCHAC0C 3NCHAC9CA 3NCHAC0CA	15°	<ul style="list-style-type: none"> Large-diameter balls enable high load-carrying capacity. Ceramic balls realize excellent high-speed performance. 	106
		20°				
	 Ultra-high-speed types	3NCHAD0CA 3NCHAF9CA 3NCHAF0CA	20°	<ul style="list-style-type: none"> These bearings have holes for oil / air lubrication. They are suitable for ultrahigh-speed applications. Ceramic balls realize excellent high-speed performance. 	114	
	20°					
 NN-type double row cylindrical roller bearings	 	NN30 NN30K	—	<ul style="list-style-type: none"> Bearings with tapered bores (K) are also available for applications using tapered shafts. For radial internal clearance values, use non-interchangeable bearings. 	121	
 NNU-type double row cylindrical roller bearings	 					NNU49 NNU49K
 N-type single row cylindrical roller bearings	 	N10 N10K	—	<ul style="list-style-type: none"> Bearings with tapered bores (K) are also available for applications using tapered shafts. For radial internal clearance values, use non-interchangeable bearings. This type of bearing produces less heat and has better high-speed performance than double row cylindrical roller bearings. 		

Table 1. 1(2) Types and structures of precision ball & roller bearings for machine tools

Bearing types	Cross-sections	Bearing series	Contact angles	Features and descriptions	Page No.
 Double-direction angular contact thrust ball bearings		2344B	60°	<ul style="list-style-type: none"> Placed on the small tapered-bore diameter side of NN30K, or used together with NN30. 	135
		2347B		<ul style="list-style-type: none"> Placed on the large tapered-bore diameter side of NN30K. 	
		2394B	60°	<ul style="list-style-type: none"> Placed on the small tapered-bore diameter side of NNU49K, or used together with NNU49. 	
		2397B		<ul style="list-style-type: none"> Placed on the large tapered-bore diameter side of NNU49K. 	
 High-speed pair-mounted angular contact ball bearings		ACT0DB	30°	<ul style="list-style-type: none"> High-speed bearings of the same bore and outside diameters as double-direction angular contact thrust ball bearings 2344B. 	
		ACT0DBB	40°	<ul style="list-style-type: none"> They are placed on the small tapered-bore diameter side of NN30K. 	
 Tapered roller bearings		329JR 320JR 302JR 322JR	Nominal contact angles: greater than 10° and equal to or less than 17°	<ul style="list-style-type: none"> Metric series single row tapered roller bearings complying with ISO standards. 	155

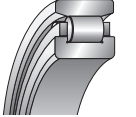
2 Support bearings and support bearing units for precision ball screws

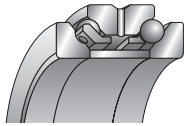
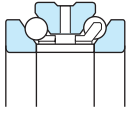
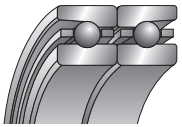
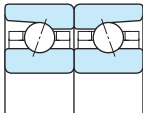
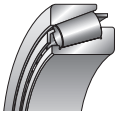
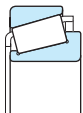
Bearing types	Cross-sections	Bearing series	Contact angles	Features and descriptions	Page No.
 Support bearings for precision ball screws	 Both-side sealed type Matching example of one-side sealed type	SAC	60°	<ul style="list-style-type: none"> Standard preloads are specified, respectively, for 2-, 3-, and 4-row matched bearings. Flush-ground G-type bearings are also available. The support bearing for precision ball screws can correspond to the type with contact-seal. Consult JTEKT if desiring information about the type with seal and the matching method. 	169
 Support bearing units for precision ball screws		BSU	(60°)	<ul style="list-style-type: none"> Support bearing units consist of a support bearing for precision ball screws (SAC) and a precision housing. Fitting this bearing unit is very simple. 	

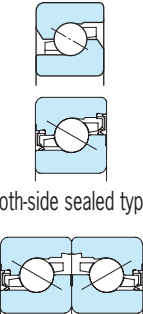
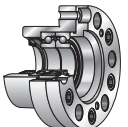
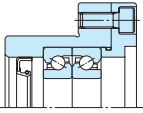
2. Selection of bearings

In order to select the optimum bearing to realize the intended design of a machine, it is necessary to consider specific operating conditions of the machine, bearing requirements, designs of parts around the bearing, marketability, and cost performance.

Table 2. 1 specifies the general procedure for selecting a bearing, and operating conditions to be taken into consideration. Note, however, that when selecting a bearing, priority should be given to meeting the most critical requirement rather than following a given procedure.

Table 2. 1 Procedure for selecting bearings and operating conditions to be taken into consideration

Selection procedure	Operating condition to be taken into consideration	Related information on bearings	Page No.	
① Bearing types and arrangements	<ul style="list-style-type: none"> · Installation space · Magnitude, direction, and types of load applied to bearings · Rotational speeds · Noise/frictional torque · Method of mounting and dismounting · Marketability and cost performance 	<ul style="list-style-type: none"> · Bearing types · Bearing arrangement examples 	15 16	
② Bearing dimensions	<ul style="list-style-type: none"> · Dimensions of bearing mounting positions · Dynamic equivalent load and rating life · Rotational speeds 	<ul style="list-style-type: none"> · Bearing rating life · Basic dynamic load ratings · Dynamic equivalent loads · Permissible axial loads 	18 18 20 24	
③ Bearing tolerance class	<ul style="list-style-type: none"> · Running accuracy (runout) · Rotational speeds 	<ul style="list-style-type: none"> · Noise/frictional torque · Bearing tolerances (Dimension tables) 		
④ Fitting and internal clearance	<ul style="list-style-type: none"> · Loading condition · Operational temperature distribution · Shaft and housing materials · Dimensions and tolerances · Temperature differences between inner ring and outer ring · Rotational speed 	<ul style="list-style-type: none"> · Fitting · Recommended fitting · Running accuracy of shafts and housings · Bearing preload · Internal clearance (Dimension tables) of bearings 	28 35 25 28	
⑤ Type and material of cage	<ul style="list-style-type: none"> · Rotational speeds · Noise · Lubrication methods 			
⑥ Lubrication method, lubricant, and sealing device	<ul style="list-style-type: none"> · Operating temperatures · Sealing device · Lubricants 	<ul style="list-style-type: none"> · Rotational speeds · Lubrication methods 	<ul style="list-style-type: none"> · Limiting speeds of bearings · Lubrication of bearings 	30 31
⑦ Method of mounting and dismounting, and mounting dimensions	<ul style="list-style-type: none"> · Method of mounting and dismounting 	<ul style="list-style-type: none"> · Handling of bearings 	192	
Decision on final specifications of bearing and parts around bearing				

If you wish to consult **JTEKT** about specifications, fill out the supplementary **table 7 "Specification report of bearing for main shaft of machine tool"** on page 220, and contact **JTEKT**.

3. Selection of bearing types

When selecting a bearing type, it is of critical importance to fully understand the operating conditions of the bearing.

Table 3. 1 shows principal items to be considered and how to select a bearing type.

Table 3. 1 Selection of bearing types

Items to be considered	How to select a type
<p>① Installation space</p> <p>Bearing can be installed in target equipment</p>	<ul style="list-style-type: none"> When designing a shaft system, critical factors on the whole are shaft rigidity and strength, therefore, shaft diameter, namely, the bore diameter of the bearing is determined first. The installation space determined by types and the dimension series of the bearings used for the spindles of machine tools are shown in Fig. 3. 1. Select the optimum bearing from the types illustrated.
<p>② Load</p> <p>Load magnitude, type and direction which applied</p> <p>The load capacity of the bearing is expressed in terms of the basic load rating, the value of which is given in the bearing dimension tables.</p>	<ul style="list-style-type: none"> Select the optimum bearing type taking into consideration the magnitude of the load applied to the bearing, whether the load is axial or radial, whether, in the case of axial load, the load is unidirectional or bidirectional, the level of vibration and shock, and other relevant factors. Radial load capacity varies as shown below with the bore diameter remaining the same. <p>(Small) $\xrightarrow{\hspace{10em}}$ (Large)</p> <p>Angular contact ball bearings Cylindrical roller bearings Tapered roller bearings</p>
<p>③ Rotational speeds</p> <p>Bearing types compatible with the machine's operating speed</p> <p>Standard values for rotational speed limits of bearings are expressed in limiting speed given in the bearing dimension tables.</p>	<ul style="list-style-type: none"> Limiting speeds of bearings largely depends not only on the bearing type, but also on other factors such as bearing size, running accuracy, type and materials of the cage, magnitude of load, and lubrication. Select a bearing taking these fully into consideration. In general, angular contact ball bearings and cylindrical roller bearings are often used for high-speed applications.
<p>④ Running accuracy</p> <p>Bearing types meeting requirements for running accuracy</p> <p>Dimension and running accuracies are standardized by JIS and the like for each bearing type.</p>	<ul style="list-style-type: none"> The spindles of machine tools, which need to rotate with high accuracy, require precision bearings meeting tolerance class 5 or better. In general, angular contact ball bearings and cylindrical roller bearings are used.
<p>⑤ Rigidity</p> <p>Bearing types meeting the rigidity requirements for machine shaft systems</p> <p>When a load is applied to a bearing, elastic deformation occurs at the contacts between the raceway and rolling elements. The smaller the elastic deformation, the higher the rigidity.</p>	<ul style="list-style-type: none"> In order to improve the machining precision of a machine tool, the rigidity of bearings as well as the rigidity of the shaft should be improved. In general, roller bearings exhibit a high rigidity, while ball bearings exhibit low rigidity. Bearings of the same type and dimensions vary in rigidity with the number of rolling elements and contact angle. The rigidity of a bearing is increased by applying a preload to the bearing (to provide a clearance of a negative value). This method is suitable for angular contact ball bearings and tapered roller bearings.
<p>⑥ Mounting and dismounting</p> <p>Bearing types should be selected taking into consideration the frequency and method of mounting and dismounting on occasions such as periodic inspection</p>	<ul style="list-style-type: none"> If the bearing is to be mounted and dismounted frequently, cylindrical roller bearings and tapered roller bearings are advantageous, as the inner ring and outer ring are separable.

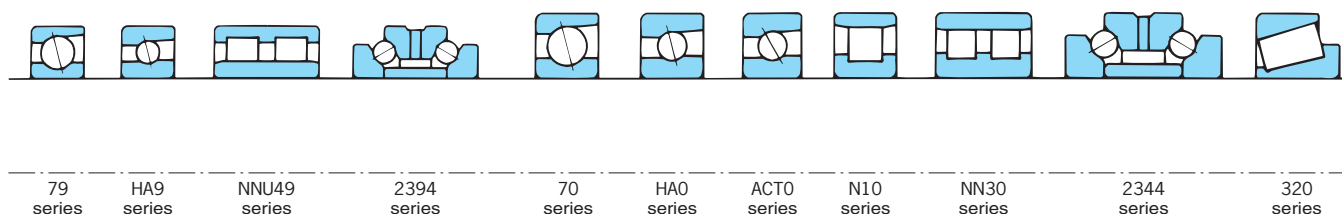

Fig. 3. 1 Installation space determined by types and dimension series of precision rolling bearings for machine tools

4. Spindle bearing arrangements

Table 4. 1 presents typical arrangements for spindle bearings for machine tools.

For high-speed spindles, the use of ceramic bearings enables higher speed.

Table 4. 1(1) Examples of spindle bearing arrangements

(The d_{mn} value represents the product of the pitch diameter of ball set d_m and the rotational speed n .)

Types	Spindle bearing arrangements	Features	Principal applications
I	 <p>(Front) (Rear)</p> <p>Single row tapered roller bearing 320JR Double row cylindrical roller bearing NN30K</p> <p>Grease lubrication d_{mn} value 0.2×10^6</p>	<ul style="list-style-type: none"> Both radial and axial loads are accepted by the tapered roller bearing. This arrangement produces high rigidity but is not suitable for high speed operation. In some cases, a double row tapered roller bearing 46C or 46T is used in the front. <ul style="list-style-type: none"> 46C : two single row bearings combined in an outward arrangement 46T : a double cup and two single row of cones constituting an outward arrangement 	Large lathes General-purpose lathes Milling machines
II	 <p>(Front) (Rear)</p> <p>Double row cylindrical roller bearing NN30 Double row cylindrical roller bearing NN30K Double-direction angular contact thrust ball bearings 2344B</p> <p>Grease lubrication d_{mn} value 0.4×10^6</p>	<ul style="list-style-type: none"> In this structure, radial load is accepted by a double row cylindrical roller bearing and axial load is accepted by a double-direction angular contact thrust ball bearing. This arrangement produces high rigidity. 	CNC lathes Machining centers Boring machines Milling machines
III	 <p>(Front) (Rear)</p> <p>Double row cylindrical roller bearing NN30K Double row cylindrical roller bearing NN30K High-speed pair-mounted angular contact ball bearings ACT0DB or ACT0BDB</p> <p>Grease lubrication d_{mn} value 0.5×10^6</p>	<ul style="list-style-type: none"> A high-speed matched pair angular contact ball bearing is used instead of the double-direction angular contact thrust ball bearing in Type II. Contact angles of the high-speed pair-mounted angular contact ball bearings are 30° for ACT0DB and 40° for ACT0BDB. 	CNC lathes Machining centers Milling machines
IV	 <p>(Front) (Rear)</p> <p>Standard angular contact ball bearing 70C Double row cylindrical roller bearing NN30K</p> <p>Grease lubrication d_{mn} value 0.65×10^6 Oil / air lubrication d_{mn} value 1.0×10^6</p>	<ul style="list-style-type: none"> Both radial and axial loads are accepted by the angular contact ball bearing. This arrangement is superior to Type III in high-speed performance, but inferior in radial and axial rigidity. 	CNC lathes Machining centers Milling machines

Table 4. 1(2) Examples of spindle bearing arrangements

Types	Spindle bearing arrangements	Features	Principal applications					
V High-speed	 <p>(Front) (Rear)</p> <p>High-speed angular contact ball bearing HAR0C Double row cylindrical roller bearing NN30K</p> <table border="1" data-bbox="284 707 833 779"> <tr> <td>Grease lubrication</td> <td rowspan="2">$d_m n$ value</td> <td>0.7×10^6</td> </tr> <tr> <td>Oil / air lubrication</td> <td>1.1×10^6</td> </tr> </table>	Grease lubrication	$d_m n$ value	0.7×10^6	Oil / air lubrication	1.1×10^6	<ul style="list-style-type: none"> The front bearing of Type IV is converted to a high-speed type. 	CNC lathes Machining centers Milling machines
Grease lubrication	$d_m n$ value	0.7×10^6						
Oil / air lubrication		1.1×10^6						
VI High-speed/high-precision	 <p>(Front) (Rear)</p> <p>High-speed angular contact ball bearing HAR0C</p> <table border="1" data-bbox="284 1126 833 1198"> <tr> <td>Grease lubrication</td> <td rowspan="2">$d_m n$ value</td> <td>0.85×10^6</td> </tr> <tr> <td>Oil / air lubrication</td> <td>1.1×10^6</td> </tr> </table>	Grease lubrication	$d_m n$ value	0.85×10^6	Oil / air lubrication	1.1×10^6	<ul style="list-style-type: none"> High-speed angular contact ball bearings are used in both the front and rear to provide greater high-speed performance. Factors such as thermal expansion should be taken into consideration for preload settings. 	Boring machines Machining centers
Grease lubrication	$d_m n$ value	0.85×10^6						
Oil / air lubrication		1.1×10^6						
VII High-speed/high-precision	 <p>(Front) (Rear)</p> <p>Standard angular contact ball bearing 70C or high-speed angular contact ball bearing HAR0C</p> <table border="1" data-bbox="284 1568 833 1639"> <tr> <td>Grease lubrication</td> <td rowspan="2">$d_m n$ value</td> <td>1.0×10^6</td> </tr> <tr> <td>Oil / air lubrication</td> <td>1.45×10^6</td> </tr> </table>	Grease lubrication	$d_m n$ value	1.0×10^6	Oil / air lubrication	1.45×10^6	<ul style="list-style-type: none"> Constant-pressure preloading is used to prevent increase in preload due to heat. <p>[This arrangement produces a lower rigidity than that produced by position preloading, but is superior in high-speed performance.]</p>	Grinding machines
Grease lubrication	$d_m n$ value	1.0×10^6						
Oil / air lubrication		1.45×10^6						
VIII Built-in motor	 <p>(Front) (Rear)</p> <p>High-speed angular contact ball bearing HAR0C Single row cylindrical roller bearing NU10K</p> <table border="1" data-bbox="284 2009 833 2080"> <tr> <td>Oil / air lubrication</td> <td>$d_m n$ value</td> <td>1.05×10^6</td> </tr> </table>	Oil / air lubrication	$d_m n$ value	1.05×10^6	<ul style="list-style-type: none"> A high-frequency motor is built in Types IV to VI. Since the driving system consisting of belts, gears, couplings, etc. can be omitted, this arrangement saves space and reduces vibration. The high-speed angular contact ball bearing is used in the front, and the single-row cylindrical roller bearing is used in the rear. 	Machining centers		
Oil / air lubrication	$d_m n$ value	1.05×10^6						

5. Service life of bearings

5.1 Rating life of bearings

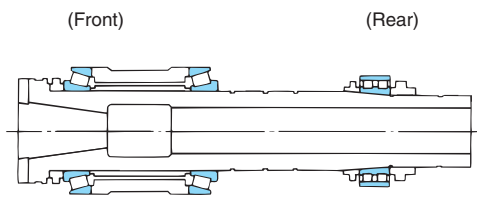
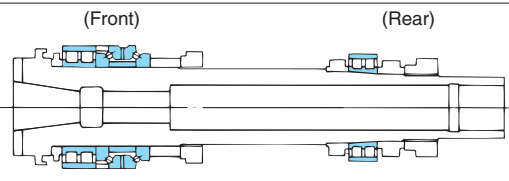
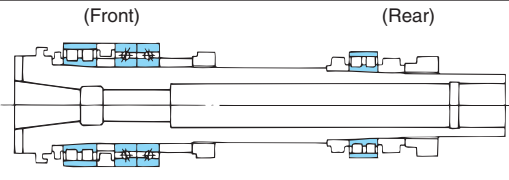
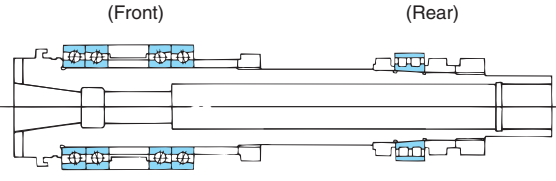
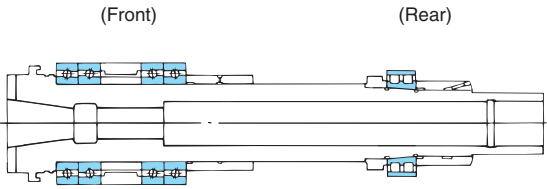
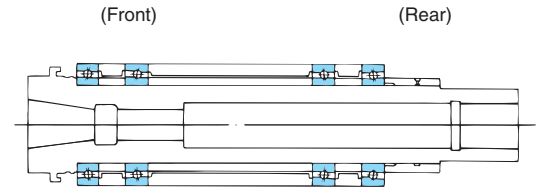
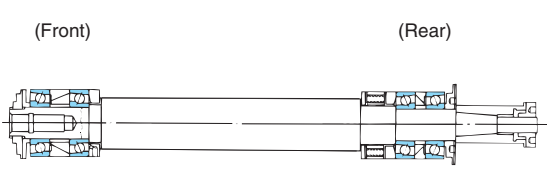
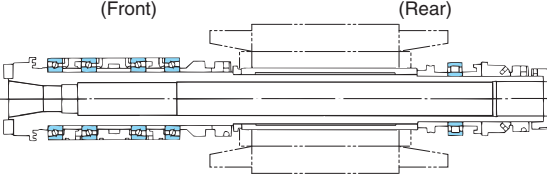
When a bearing rotates under a load, the surfaces of the inner and outer ring raceways and the surfaces of the rolling elements are constantly subjected to repetitive loads. Even under proper operating conditions this results in scale-like damage (known as flaking) of the surfaces due to fatigue.

The total number of rotations before this damage occurs is known as "(fatigue) service life" of the bearing.

A substantial variation in "(fatigue) service life" occurs even if bearings of the same structure, dimensions, materials, machining method, etc. are operated under the same conditions.

This variation in fatigue, an intrinsic phenomenon to the material, should be examined statistically.

The total number of rotations at which 90% of the same type of bearings individually operated under the same conditions are free of damage caused by rolling fatigue (in other words, service life of 90% reliability), is referred to as "basic rating life of the bearing."

In some cases, however, bearings, when actually mounted and operated on a machine, may become inoperative due to causes other than damage by fatigue (wear, seizure, creep, fretting, brinelling, cracking, etc.).

By giving sufficient consideration to the selection of bearings, installation, lubrication, and the like, it is possible to avoid such causes.

5.2 Service life calculation of bearings

5.2.1 Basic dynamic load ratings

The strength of a bearing against rolling fatigue—that is, the basic dynamic load rating representing the bearing load capacity—is the net radial load (in the case of a radial bearing) or central axial load (in the case of a thrust bearing) such that its magnitude and direction are constant and the bearing can attain a basic rating life of 1 million rotations under the condition that the inner ring rotates while the outer ring is stationary (or vice versa).

These are called "basic dynamic radial load rating (C_r)" or "basic dynamic axial load rating (C_a)," respectively. Values for these items are given in the bearing dimension tables.

5.2.2 Basic rating life

The relationship among the basic dynamic load rating, the dynamic equivalent load, and the basic rating life is expressed by equation (5. 1).

If a bearing is to be operated at a constant rotational speed, its service life is conveniently expressed in hours as determined by equation (5. 2).

(Total number of rotations)

$$L_{10} = \left(\frac{C}{P}\right)^p \dots\dots\dots (5. 1)$$

(Hours) $L_{10h} = \frac{10^6}{60n} \left(\frac{C}{P}\right)^p \dots\dots\dots (5. 2)$

where,

- L_{10} : basic rating life 10⁶ rotations
 - L_{10h} : basic rating life h
 - P : dynamic equivalent load N
 - C : basic dynamic load rating N
 - n : rotational speed min⁻¹
 - p : $p=3$ for ball bearings
 - $p=10/3$ for roller bearings
-

When a bearing is operated with a dynamic equivalent load of P and a rotational speed of n , the basic dynamic load rating C of the bearing, which is suitable for meeting the design service life, is given by equation (5. 3). Thus the bearing dimensions are determined by selecting a bearing from the bearing dimension tables, which meets requirement C .

$$C = P \left(L_{10h} \times \frac{60n}{10^6} \right)^{1/p} \dots\dots\dots (5. 3)$$

[Reference] A method for determining the rating life of a bearing in a simplified method

A formula for determining service life, in which a service life coefficient (f_h) and speed coefficient (f_n) are applied in equation (5. 2), is shown below.

$$L_{10h} = 500 f_h^p \dots\dots\dots (5. 4)$$

Service life coefficient :

$$f_h = f_n \frac{C}{P} \dots\dots\dots (5. 5)$$

Speed coefficient :

$$f_n = \left(\frac{10^6}{500 \times 60 n} \right)^{1/p} \\ = (0.03 n)^{-1/p} \dots\dots\dots (5. 6)$$

Values of f_n , f_h , and L_{10h} are approximated by the nomograms shown in **Fig. 5. 1**.

How to use nomograms

■ Operating conditions (example)

- Cylindrical roller bearing
NN3014K $C=96.9$ kN
- Rotational speed
 $n=7\,000$ min⁻¹
- Dynamic equivalent load
 $P=4.9$ kN

① Speed coefficient :

Since $n=7\,000$
 f_n reads: $f_n=0.2$

② Service life coefficient :

f_h is obtained as follows.

$$f_h = f_n \frac{C}{P} = 0.2 \times \frac{96.9}{4.9} = 3.96$$

③ Rating life :

Since $f_h=3.96$,
 L_{10h} is: $L_{10h}=49\,000$

Ball bearing

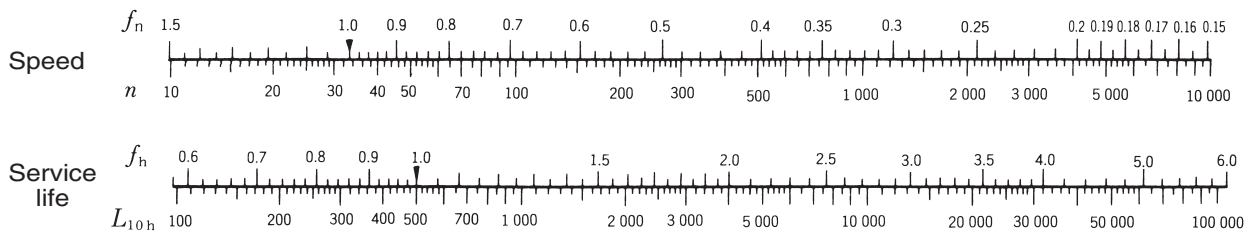

Roller bearing

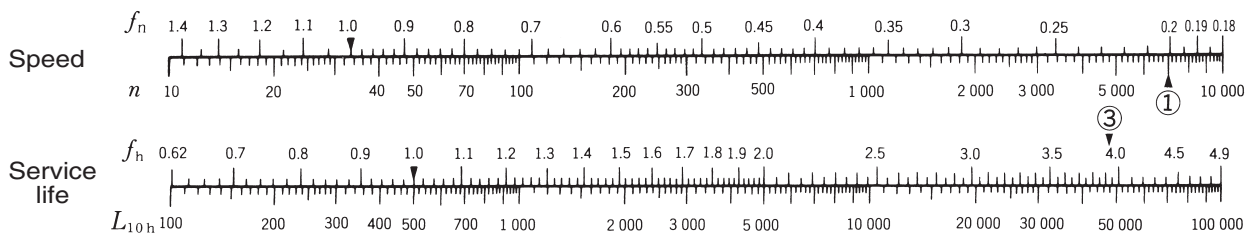

Fig. 5. 1 Rotational speed (n) vs. speed coefficient (f_n) and service life coefficient (f_h) vs. service life (L_{10h})

5.3 Dynamic equivalent loads

Bearings are used under different conditions. For example, they are often subjected to a resultant load consisting of radial and axial loads, the magnitudes of which may vary.

Consequently, it is not possible to directly compare the actual load that a bearing receives and the basic dynamic load rating.

In such a case, a calculation is carried out for comparison and examination, in which a load having a constant magnitude and direction, is applied to the bearing center such that it would make the service life of the bearing the same as that resulting from the actual load and rotational speed.

This theoretical load is known as the dynamic equivalent load (P).

5.3.1 Calculation of dynamic equivalent load

The dynamic equivalent loads of a radial bearing and a thrust bearing ($\alpha \neq 90^\circ$) receiving a resultant load constant in magnitude and direction is obtained as illustrated below.

$$P = XF_r + YF_a \dots\dots\dots (5.7)$$

where,

P : dynamic equivalent load N
 (For radial bearings,
 " P_r : dynamic equivalent radial load"
 and for thrust bearings,
 " P_a : dynamic equivalent axial load,"
 respectively, are used.)

F_r : radial load N

F_a : axial load N

X : radial load coefficient

Y : axial load coefficient

(Values of X and Y are noted
 in the bearing dimension tables.)

1) If $F_a/F_r \leq e$ for a single row radial bearing, $X=1$ and $Y=0$ are used.

Hence, the dynamic equivalent load will be

$$P_r = F_r.$$

(e denotes the limit of F_a/F_r , whose values
 are listed in the bearing dimension tables.)

2) Application of a radial load to a single row angular contact ball bearing, or tapered roller bearing, produces a component of force (F_{ac}) in the axial direction (Fig. 5.2).

Therefore, a pair of bearings are usually used to arrange face-to-face or back-to-back.

The component of force in the axial direction is determined by the following equation.

$$F_{ac} = \frac{F_r}{2Y} \dots\dots\dots (5.8)$$

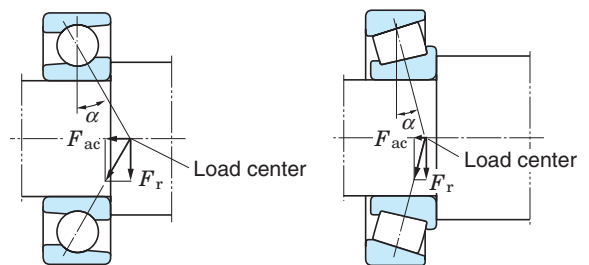

(Dimensions representing the position of load center are noted in the bearing dimension tables.)

Fig. 5.2 Components of force in axial direction

Table 5.1 (page 21) shows ways of determining the dynamic equivalent load where a radial load and external axial load (K_a) are applied to these bearings.

Table 5.1 Calculations of dynamic equivalent loads for two opposing single row angular contact ball bearings or tapered roller bearings

Bearing arrangement		Loading condition	Bearing	Axial load	Dynamic equivalent load
Back-to-back	Face-to-face				
		$\frac{F_{rB}}{2Y_B} + K_a \geq \frac{F_{rA}}{2Y_A}$	Bearing A	$\frac{F_{rB}}{2Y_B} + K_a$	$P_A = XF_{rA} + Y_A \left(\frac{F_{rB}}{2Y_B} + K_a \right)$ Note that $P_A = F_{rA}$ if $P_A < F_{rA}$
			Bearing B	—	$P_B = F_{rB}$
		$\frac{F_{rB}}{2Y_B} + K_a < \frac{F_{rA}}{2Y_A}$	Bearing A	—	$P_A = F_{rA}$
			Bearing B	$\frac{F_{rA}}{2Y_A} - K_a$	$P_B = XF_{rB} + Y_B \left(\frac{F_{rA}}{2Y_A} - K_a \right)$ Note that $P_B = F_{rB}$ if $P_B < F_{rB}$
		$\frac{F_{rB}}{2Y_B} \leq \frac{F_{rA}}{2Y_A} + K_a$	Bearing A	—	$P_A = F_{rA}$
			Bearing B	$\frac{F_{rA}}{2Y_A} + K_a$	$P_B = XF_{rB} + Y_B \left(\frac{F_{rA}}{2Y_A} + K_a \right)$ Note that $P_B = F_{rB}$ if $P_B < F_{rB}$
		$\frac{F_{rB}}{2Y_B} > \frac{F_{rA}}{2Y_A} + K_a$	Bearing A	$\frac{F_{rB}}{2Y_B} - K_a$	$P_A = XF_{rA} + Y_A \left(\frac{F_{rB}}{2Y_B} - K_a \right)$ Note that $P_A = F_{rA}$ if $P_A < F_{rA}$
			Bearing B	—	$P_B = F_{rB}$

[Remarks] 1. These calculations are applicable where during operation the internal clearance and preload are 0 (zero).
 2. Radial loads are assumed to be positive even if they are applied in the opposite direction of the arrows shown above.

5. 3. 2 Mean dynamic equivalent loads for variable loads

When a load, applied to a bearing, varies in magnitude and direction, it is necessary to obtain a mean dynamic equivalent load that may result in the same service life as would result under actual variation conditions.

Ways of determining the mean dynamic equivalent load P_m suitable for different variation conditions are shown in **Table 5. 2, (1) to (4)**.

In the case when a stationary load and a rotational load are applied simultaneously, as shown in **(5)**, the mean dynamic equivalent load is given by equation (5. 13).

Table 5. 2 Ways of determining mean dynamic equivalent loads from variable loads

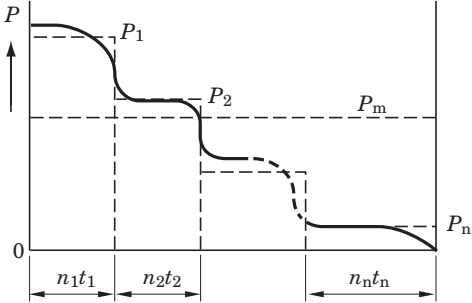
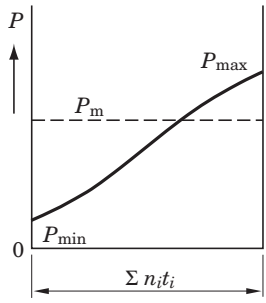
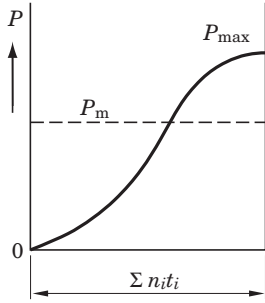
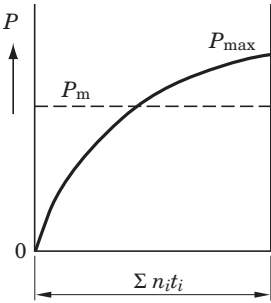
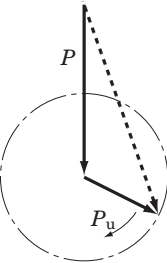
(1) Stepwise variation	(2) Simple variation	(3) Sine like curve variation
		
$P_m = \sqrt[p]{\frac{P_1^p n_1 t_1 + P_2^p n_2 t_2 + \dots + P_n^p n_n t_n}{n_1 t_1 + n_2 t_2 + \dots + n_n t_n}} \dots (5. 9)$	$P_m = \frac{P_{min} + 2P_{max}}{3} \dots (5. 10)$	$P_m = 0.68 P_{max} \dots (5. 11)$
(4) Sine like curve variation (Upper portion of a sine curve)	(5) Stationary and rotational loads being applied at the same time	
		
$P_m = 0.75 P_{max} \dots (5. 12)$	$P_m = f_m (P + P_u) \dots (5. 13)$	

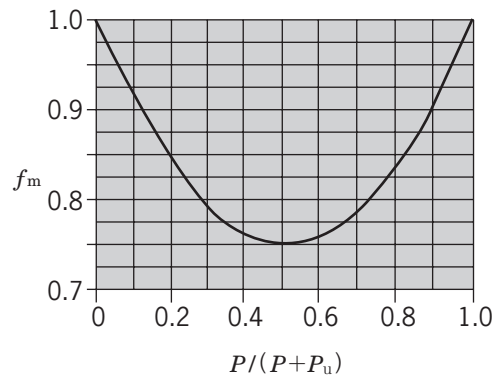

Fig. 5. 3 f_m Coefficient

• In (1) to (4) in Table 5. 2:

- P_m : mean dynamic equivalent load N
- P_1 : dynamic equivalent load applied at a rotational speed of n_1 for t_1 hours N
- P_2 : dynamic equivalent load applied at a rotational speed of n_2 for t_2 hours N

⋮ ⋮ ⋮

- P_n : dynamic equivalent load applied at a rotational speed of n_n for t_n hours N

- P_{min} : minimum dynamic equivalent load N

- P_{max} : maximum dynamic equivalent load N

$\Sigma n_i t_i$: total number of rotations in a period from t_1 to t_i

p : $p=3$ for ball bearings

$p=10/3$ for roller bearings

(Reference) The mean rotational speed n_m is obtained by the following equation.

$$n_m = \frac{n_1 t_1 + n_2 t_2 + \dots + n_n t_n}{t_1 + t_2 + \dots + t_n}$$

• In (5) in Table 5. 2:

- P_m : mean dynamic equivalent load N
- f_m : coefficient (see Fig. 5. 3)
- P : stationary load N
- P_u : rotational load N

5. 4 Basic static load rating and static equivalent load

5. 4. 1 Basic static load rating

Excessive static load or impact load even at very low rotation causes partial permanent deformation of the rolling element and raceway contacting surfaces. This permanent deformation increases with the load; if it exceeds a certain limit, smooth rotation will be hindered.

The basic static load rating is the static load which responds to the calculated contact stress shown below, at the contact center between the raceway and rolling elements which receive the maximum load.

- Self-aligning ball bearings ... 4 600 MPa
- Other ball bearings 4 200 MPa
- Roller bearings 4 000 MPa

The total extent of contact stress-caused permanent deformation on surfaces of rolling elements and raceway will be approximately 0.000 1 times greater than the rolling element diameter.

The basic static load rating for radial bearings is

specified as the basic static radial load rating, and for thrust bearings, as the basic static axial load rating. These load ratings are listed in the bearing specification table, using C_{0r} and C_{0a} respectively.

These values are prescribed by ISO 78/1987 and are subject to change by conformance to the latest ISO standards.

5. 4. 2 Static equivalent load

The static equivalent load is a theoretical load calculated such that, during rotation at very low speed or when bearings are stationary, the same contact stress as that imposed under actual loading condition is generated at the contact center between raceway and rolling element to which the maximum load is applied.

For radial bearings, radial load passing through the bearing center is used for the calculation; for thrust bearings, axial load in a direction along the bearing axis is used.

The static equivalent load can be calculated using the following equations.

[Radial bearings]

...The greater value obtained by the following two equations is used.

$$P_{0r} = X_0 F_r + Y_0 F_a \dots\dots\dots (5. 14)$$

$$P_{0r} = F_r \dots\dots\dots (5. 15)$$

[Thrust bearings]

($\alpha \neq 90^\circ$)

$$P_{0a} = X_0 F_r + F_a \dots\dots\dots (5. 16)$$

[When $F_a < X_0 F_r$,

the solution becomes less accurate.]

($\alpha = 90^\circ$)

$$P_{0a} = F_a \dots\dots\dots (5. 17)$$

where,

P_{0r} : static equivalent radial load N

P_{0a} : static equivalent axial load N

F_r : radial load N

F_a : axial load N

X_0 : static radial load factor

Y_0 : static axial load factor

(values of X_0 and Y_0 are listed in the bearing specification table.)

5. 4. 3 Safety coefficient

The allowable static equivalent load for a bearing is determined by the basic static load rating of the bearing; however, bearing service life, which is affected by permanent deformation, differs in accordance with the performance required of the

bearing and operating conditions.

Therefore, a safety coefficient is designated, based on empirical data, so as to ensure safety in relation to basic static load rating.

$$f_s = \frac{C_0}{P_0} \dots\dots\dots (5. 18)$$

where,

- f_s : safety coefficient (ref. **Table 5. 3**)
- C_0 : basic static load rating N
- P_0 : static equivalent load N

Table 5. 3 Values of safety coefficient f_s

Operating condition		f_s (min.)	
		Ball bearing	Roller bearing
With bearing rotation	When high accuracy is required	2	3
	Normal operation	1	1.5
	When impact load is applied	1.5	3
Without bearing rotation (occasional oscillation)	Normal operation	0.5	1
	When impact load or uneven distribution load is applied	1	2

[Remark] For spherical thrust roller bearings, $f_s \geq 4$.

5. 5 Service life of greases

The previous section explained the fatigue service life of bearings. Spindle bearings for machine tools, however, rarely have a problem of bearing service life caused by load.

When grease lubrication is used, ineffective lubrication may occasionally occur, resulting in bearing failures. It is therefore necessary to give sufficient consideration to selecting the brand and the amount of grease to be used, for given operating conditions.

Refer to "**8. Lubrication of bearings**" for grease lubrication.

5. 6 Permissible axial loads

A large axial load may be applied to the bearings for main shafts of machine tools when, for example, tools are changed.

Application of a large axial load to an angular contact ball bearing may cause the contact ellipse formed between the ball and raceway surface to deviate beyond the raceway surface (see **Fig. 5. 4**).

Furthermore, if the stress becomes excessive, the rolling elements and raceway surface may sustain permanent deformation (nicks), possibly resulting in increased runout or vibration.

The smaller one of the following values is defined as the permissible axial load (static). And the permissible axial load (static) for each bearing is shown in the dimension list of the bearings.

- The load generated when the end of the contact ellipse formed between the ball and the raceway reaches the shoulder of the inner or outer ring.
- The load generated when the pressure of the contact surface between the ball and the raceway reaches the standard value calculated based on the actual results.

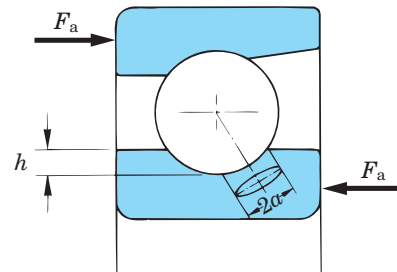

where,

- h : bearing shoulder height
- a : half length of the contact ellipses' major axis
- F_a : axial load

Fig. 5. 4 Contact ellipse

6. Rigidity and preload of bearings

6.1 Rigidity of bearings

The rigidity of a bearing has a considerable influence on the rigidity of the spindle of the machine tool. The rigidity of a bearing can be improved by the following methods.

- ① Roller bearings, in which line contact is made between the raceway surface and the rolling element, are used when a high radial rigidity is required.
- ② In the case where high axial rigidity is required, stack mounting angular contact ball bearings, are generally used.
Furthermore, bearings with a large contact angle are used.
- ③ For high-speed and high-rigidity requirements, it is effective to reduce the diameter and increase the number of rolling elements.

It is also possible to improve the rigidity of a bearing by using ceramics (silicon nitride) for the rolling elements which is superior in Young's modulus.

Bearings having ceramic rolling elements also offer improved high-speed performance since their density is lower than that of bearing steel, yielding a small centrifugal force even under high-speed rotation.

- ④ Apply a preload to the bearing.

6.2 Preload of bearings

Preloading means setting the inner clearance to be a negative value and loading the bearing after mounting it.

In case of the angular contact ball bearing and tapered roller bearing, an axial load is applied when preloading. And in case of the cylindrical roller bearing, a radial load is applied when preloading.

6.2.1 Objective of preload

- To improve rigidity
- To improve the positioning accuracy in the radial and axial directions, and to improve the running accuracy as well, by minimizing the runout of the shaft
- To reduce smearing by controlling whirl slip, orbital slip, and rotational slip of rolling elements in high-speed rotations
- To prevent noise caused by vibration and resonance

6.2.2 Methods for preloading

There are two major methods for preloading the angular contact ball bearing and tapered roller bearing; position preloading and constant-pressure preloading.

In the position preloading method, the bearing and spacer, whose dimensions are adjusted to the specified values beforehand, are used. In the constant-pressure preloading method, coil springs or disk springs are used to preload the bearing.

Usage examples and comparison of these methods are shown in **Fig. 6.1**.

Also, these preloading methods can be switched over when rotating, and the amount of the preload (load) can be gradually changed in accordance with the speed of the rotation.

Table 6.1 Methods for preloading

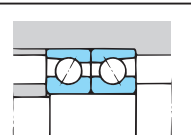
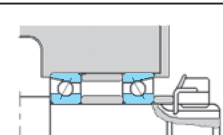
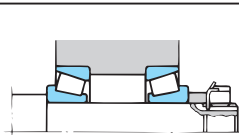
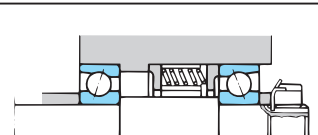
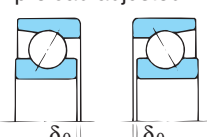
Position preloading		Constant-pressure preloading	
<p>When applying the same preload, the displacement to load is smaller and the rigidity is higher than when using the constant-pressure preloading method.</p> <p>When rotating at high speed, the use of this method is limited because the preload amount varies depending on the mounting conditions, centrifugal force and temperature rise.</p>		<p>This method is applicable when rotating at high speed because there is less preload variation when rotating than when using the position preloading method, and almost constant preload can be maintained.</p> <p>However, the improvement of the rigidity of the shaft is not as good as when using the position preloading method.</p>	
			
<p>① A method using matched pair bearings with the preload adjusted.</p> 	<p>② A method using a spacer of preadjusted size.</p>	<p>③ A method using a nut or bolt capable of adjusting the amount of preload in the axial direction. (In this case, confirm that the appropriate preload is applied while measuring the starting torque, etc. This method is not suitable for conditions which require high precision, because the bearing tends to tilt easily. In these conditions, methods 1) and 2) are recommended.)</p>	<p>A method using coil springs or disk springs to apply preload. When using the coil springs, place them on the circumference at regular intervals so that the pressure is applied equally.</p>

6. 2. 3 Preload and axial rigidity

Fig. 6. 1 shows the relationship between preload (position preload) and rigidity, namely, axial displacement of a back-to-back arrangement bearing.

Applying a preload P (by tightening the inner ring in the axial direction), as shown in Fig. 6. 1, results in bearings A and B respectively being displaced by δ_{aA} . The clearance between the inner rings $2\delta_{a0}$ will then become 0 (zero).

When an external axial load T is applied to these bearings, their resultant displacement as a pair-mounted bearing set can be obtained as δ_a .

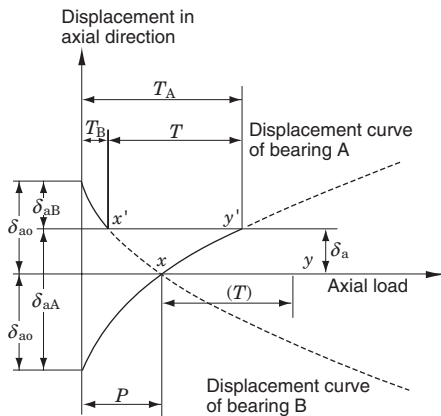
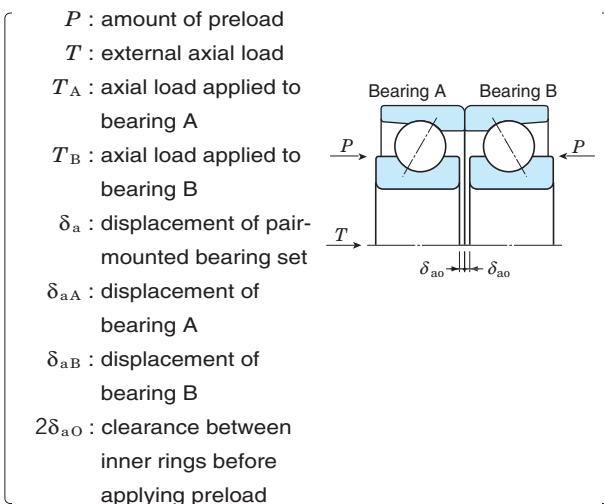

Fig. 6. 1 Preload diagram for position preloading

[Reference] How to determine δ_a in Fig. 6. 1

- ① Obtain the displacement curve of bearing A.
- ② Obtain the displacement curve of bearing B: this is the curve symmetrical with respect to the transverse axis and the intersection x at the preload P .
- ③ Assuming an external load T , obtain a line $x-y$ on the transverse axis passing through x . By parallel displacement of line $x-y$ along the displacement curve of bearing B, the intersection y' passing through the displacement curve of bearing A is obtained.
- ④ δ_a is determined as the distance between the lines $x'-y'$ and $x-y$.

Fig. 6. 2 shows the relationship between preload and rigidity when a constant-pressure preload is applied to the same pair-mounted bearing as shown in Fig. 6. 1.

Since the rigidity of the spring is negligible in this case, the rigidity of the bearing is approximately equal to that of a single bearing given a preload P .

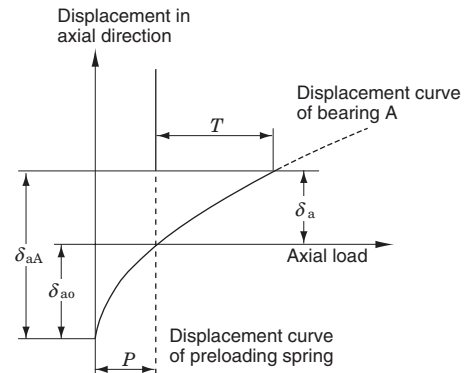

Fig. 6. 2 Preload diagram of constant-pressure preloading

Comparison of axial rigidity of the position preloading and the constant-pressure preloading is shown in Fig. 6. 3.

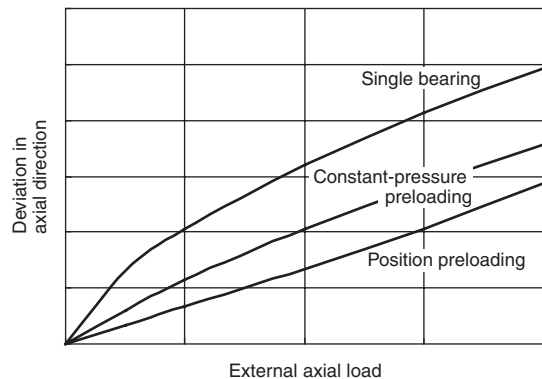

Fig. 6. 3 Comparison of axial rigidity

6. 2. 4 Amount of preload

If the amount of preload to the bearing is increased, the rigidity is improved.

However, as the load is applied to the bearing, the life may become shorter and abnormal heat may be generated, resulting in serious failure, including early damage, seizure, etc.

Also, in case of position preloading, the amount of preload varies depending on the mounting conditions, including fitting of the bearing, the centrifugal force generated during the operation and the temperature rise.

6. 2. 5 Variation of position preloading due to fitting and rotation

1) Preload in mounting the bearing

The angular contact ball bearing is shown as a model in Fig. 6. 4a.

In case of the bearing for the main shaft of a machine tool, for which the inner ring is usually rotated, the interference fit is employed for the inner ring, and the clearance fit is employed for the outer ring. However, the diameter of the inner ring raceway will expand due to interference, and the axial clearance changes as shown in Fig. 6. 4b, resulting in the increase in the amount of preload.

Furthermore, if the inner ring is tightened by the shaft nut, etc., the width of the inner ring and the spacer will shrink, resulting in increase in preload.

This is the preload generated when the bearing is mounted.

2) Change of preload during rotation

During rotation, the preload is changed by centrifugal force and temperature rise.

When rotating, the inner ring is affected by the centrifugal force and the raceway expands. Due to this expansion, the preload increases as shown in Fig. 6. 4c.

Influence of temperature rise is described below.

When rotating, the temperature of the bearing increases and the components expand because of rotation resistance, stirring resistance generated by the lubricant, and other external factors.

The temperature increase of the inner ring and the rolling elements is larger than that of the outer ring, which radiates heat easily. Therefore, the internal clearance changes because of the expansion as shown in Fig. 6. 4d, and the preload is increased.

Also, the temperature difference is generated between the outer ring and the housing, and the outer ring becomes hotter than the housing, reducing the clearance of the fitting surface of the outer ring. If the clearance of the fitting surface of the outer ring is too small, the fitting of the outer ring becomes interference fitting because of the temperature difference, and the internal clearance changes due to the shrinkage of the raceway of the outer ring, increasing the preload as shown in Fig. 6. 4e.

As a result, it is also important to take into consideration the case where the housing cools off excessively.

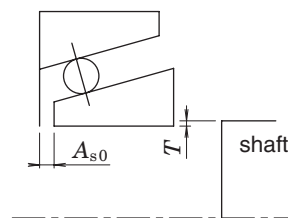

Fig. 6. 4a Bearing before mounting

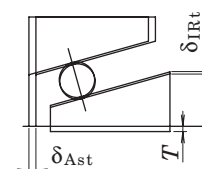

Fig. 6. 4b Change of dimension due to inner ring interference

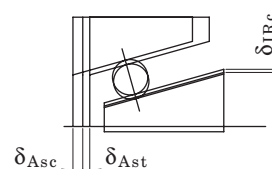

Fig. 6. 4c Change of dimension due to centrifugal expansion of inner ring raceway

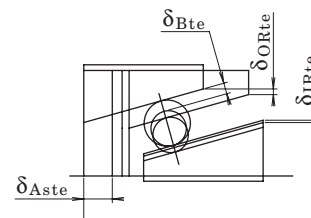

Fig. 6. 4d Change of dimension due to heat expansion

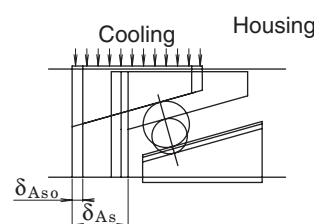

Fig. 6. 4e Change of dimension due to shrinkage of outer ring raceway

A_{s0}	: initial stand-out value (The sum of the stand-out value of a pair of bearings is the size of the clearance for which the preload is provided.)
T	: interference of inner ring
δ_{IRt}	: expansion of inner ring raceway due to inner ring interference
δ_{Ast}	: change of bearing stand-out value due to inner ring interference
δ_{IRc}	: centrifugal expansion of inner ring raceway
δ_{Asc}	: change of bearing stand-out value due to centrifugal expansion of inner ring raceway
δ_{IRte}	: heat expansion of inner ring raceway
δ_{ORte}	: heat expansion of outer ring raceway
δ_{Bte}	: heat expansion of rolling element
δ_{Aste}	: change of bearing stand-out value due to temperature rise of each component
δ_{Aso}	: change of bearing stand-out value due to shrinkage of outer ring raceway
δ_{As}	: total of change of stand-out value due to mounting conditions and rotation

6. 2. 6 Selecting preload and fitting

To maintain the initial performance of the bearing and use it in stable condition, it is necessary to select an ideal preloading method and preload amount considering the use conditions as well as the mounting conditions.

Especially, when using the bearing at high speed, it is indispensable to select an ideal preload, taking into consideration the preload change, the pressure between the raceway and the rolling elements

generated by centrifugal force, and the factors which cause spin slide of the angular contact ball bearing.

The standard preload amount of each bearing is shown in the table of bearing dimensions. Also, the interferences of the bearings for main shafts in standard use condition are shown in **Figs. 6. 2** and **6. 3** (page 26).

Consult JTEKT for detailed information about preloads and fittings when using the bearings at high speed with value $d_m n$ set at 80×10^4 or more or with a heavy load of $C_r/P_r < 13$.

Table 6. 2 Shaft fits (in the case of a rotating inner ring)

Bearing type	Shaft diameter (mm) over up to		Tolerance class of bearing and fits				
			Class 5		Classes 4, 2		
			Tolerance class of shaft or dimensional tolerance of shaft diameter (μm)	Target interference (μm)	Tolerance class of shaft or dimensional tolerance of shaft diameter (μm)	Target interference (μm)	
Angular contact ball bearings	Amount of preload preset for matched pair bearings	General	All shaft diameter	js 5	—	js 4	—
		Amount of preload preset for matched pair bearings	6 10	0 -4	0~2	0 -2.5	0~2
			10 18	+1 -4	0~2	0 -3	0~2
			18 30	+1 -5	0~2.5	+1 -3	0~2.5
			30 50	+1 -6	0~3.5	+1 -4	0~3.5
			50 80	+2 -6	0~4	+1 -4	0~4
			80 120	+3 -7	0~4.5	+2 -4	0~4.5
			120 180	+4 -8	0~5	+2 -6	0~5
			180 250	+5 -9	0~6	+3 -6	0~6
Cylindrical roller bearings (cylindrical bored in inner ring)	25 40	js 4	—	js 3	—		
	40 140	k 4	—	k 3	—		
	140 200	m 5	—	m 4	—		
	200 400	n 5	—	n 4	—		
Double-direction angular contact thrust ball bearings	All shaft diameter	h 5	—	h 4	—		
High-speed matched pair angular contact ball bearings							
Support bearings for precision ball screws							
Tapered roller bearings (metric series)	25 40	js 5	—	—	—		
	40 140	k 5	—				
	140 200	m 5	—				

[Remark] Consult JTEKT for specific operating conditions (high-speed rotation, rotating outer ring, heavy load, etc.).

Table 6. 3 Housing fits (in the case of a rotating inner ring)

Bearing type	Housing bore diameter (mm) over up to	Bearing on fixed side				Bearing on free side					
		Tolerance class of bearing and fits				Tolerance class of bearing and fits					
		Class 5		Classes 4, 2		Class 5		Classes 4, 2			
		Tolerance class of housing bore	Target clearance (μm)	Tolerance class of housing bore	Target clearance (μm)	Tolerance class of housing bore	Target clearance (μm)	Tolerance class of housing bore	Target clearance (μm)		
Angular contact ball bearings	General	All housing bore diameter		JS 5	—	JS 4	—	H 5	—	H 4	—
		Amount of preload preset for matched pair bearings	(Bearing on fixed side)				(Bearing on free side)				
	(Tolerance class of bearing and fits)				(Tolerance class of bearing and fits)						
	Classes 5, 4, 2				Classes 5, 4, 2						
	Dimensional tolerance of housing bore (μm)		Target clearance (μm)		Dimensional tolerance of housing bore (μm)		Target clearance (μm)				
	18		30	±4.5	0~4	+9 0	6~10				
	30		50	±5.5	0~4	+11 0	7~11				
	50		80	±6.5	0~5	+13 0	8~13				
	80		120	±7.5	0~5	+15 0	10~15				
	120	180	±9	0~6	+18 0	13~19					
180	250	±10	0~7	+20 0	17~24						
250	315	±11.5	0~7	+23 0	22~29						
315	400	±12.5	0~8	+25 0	26~33						
(Bearing type)	Housing bore diameter (mm) over up to	Class 5		Classes 4, 2		Class 5		Classes 4, 2			
		Tolerance class of housing bore	Target clearance (μm)	Tolerance class of housing bore	Target clearance (μm)	Tolerance class of housing bore	Target clearance (μm)	Tolerance class of housing bore	Target clearance (μm)		
Cylindrical roller bearings	All housing bore diameter	K 5	0	K 4	0						
Double-direction angular contact thrust ball bearings		K 5	—	K 4	—						
High-speed matched pair angular contact ball bearings											
Support bearings for precision ball screws		H 6	—	H 6	—						
Tapered roller bearings (metric series)		K 5	—				H 5	—			

[Remark] Consult JTEKT for specific operating conditions (high-speed rotation, outer ring rotation, heavy load, etc.).

7. Limiting speeds of bearings

The rotational speed of a bearing is restricted chiefly by temperature increases caused by frictional heat generated within the bearing. When a speed limit is reached, it becomes impossible to continue operation due to seizure and the like.

The permissible rotational speed of a bearing represents the value of limiting speed at which the bearing can continue operation without causing seizure-generated temperatures.

Accordingly, the limiting speed differs with bearing types, dimensions, accuracy, lubrication methods, quality and quantity of lubricant, shape and material of cages, loading conditions (including amount of preload), etc.

The limiting speed for grease lubrication or oil (oil / air) lubrication of bearings are given in their dimension tables.

These values are the limiting speed that are applicable where a bearing of a standard design is operated under normal loading conditions ($C_r/P_r \geq 13$, $F_a/F_r \leq \text{approx. } 0.2$).

$$\left[\begin{array}{l} C_r : \text{basic dynamic load rating} \\ P_r : \text{dynamic equivalent load} \\ F_r : \text{radial load} \\ F_a : \text{axial load} \end{array} \right]$$

Spindle bearings for machine tools are used in one of 2-, 3-, or 4-row combinations. The limiting speed of a stack mounting bearing is lower than that of a single row bearing.

The speed coefficients are shown in **Table 7. 1**. In this table, the correlations between the preload amounts and the matching methods of the bearings mounted to the shafts with position preloading are shown. Differences are made due to the heat radiation and the variation in the preload amount of each bearing.

Where a lubricant can efficiently remove the heat generated in the bearing, the limiting speed of a bearing will be greater than those given in the bearing dimension tables.

If the rotational speed of a bearing exceeds 80% of the value listed in the bearing dimension tables, careful consideration should be given to the amount of preload, lubrication method, lubricant, distance between the bearings, etc. Consult JTEKT.

Table 7. 1 Speed coefficients

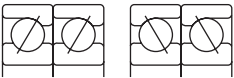
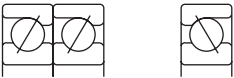
Matching method	Prefix	Preload in mounting			
		Preload S	Preload L	Preload M	Preload H
	DB	0.85	0.80	0.65	0.55
	DBB	0.80	0.75	0.60	0.45
	DBD	0.75	0.70	0.55	0.40

* The speed coefficients vary depending on the distance between the bearings.

8. Lubrication

Lubrication is a critical issue for bearings, on which their performance greatly depends.

The suitability of a lubricant and lubrication method has great influence on the performance of a bearing.

Lubrication plays the following roles.

- Lubrication of each part of the bearing reduces wear and friction.
- Removes heat in the bearing generated by friction and other causes.
- Extends the service life of bearings by constantly forming an adequate oil film on the rolling contact surfaces.
- Rust prevention and dust proofing for bearings

Lubrication is very important for spindle bearings of machine tools since such bearings require a low temperature increase under high-speed operation.

Relationships between the quantity of lubricant and power loss and between the quantity of lubricant and the temperature increase of the bearing are shown in **Fig. 8. 1**. Relationships between the viscosity of lubricant and power loss and between the viscosity of lubricant and the temperature increase of the bearing are shown in **Fig. 8. 2**.

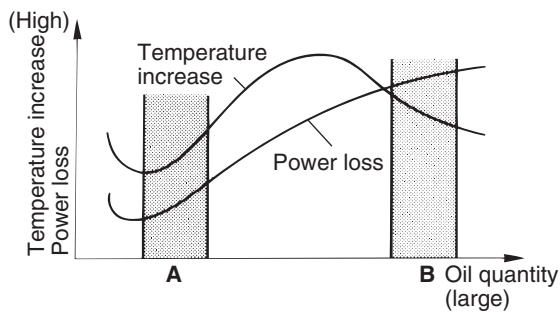

Fig. 8. 1 Relationships between lubricant quantity and power loss and between lubricant quantity and the temperature increase of the bearing

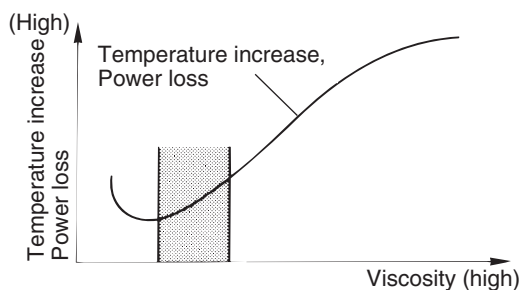

Fig. 8. 2 Relationships between viscosity of lubricant and power loss and between viscosity of lubricant and the temperature increase of the bearing

The quantity of lubricant needed to meet the low temperature increase requirement lies in zone A where the quantity of oil is small so the agitation loss is low, and zone B in which a large quantity of oil transfers heat from the bearing to the outside. Regarding the viscosity of lubricant, those which are of relatively low viscosity are suitable for meeting the above-mentioned requirement.

Note, however, that an excessively small quantity of oil or excessively low viscosity will not maintain a suitable lubricant film during operation, and further induce the chances of seizure.

For bearing lubrication methods, grease, oil / air, or oil mist lubrication is recommended in zone A in **Fig. 8. 1**, and jet lubrication, in zone B.

Table 8. 1 shows a comparison of features for various lubrication methods. It is important to select a lubrication method and a lubricant to best suit to the machine specifications.

Table 8. 1 Comparison of features of different lubrication methods

○ : advantageous
 △ : somewhat disadvantageous
 × : disadvantageous

Lubrication method	Grease lubrication	Oil / air lubrication	Oil mist lubrication	Jet lubrication
Total cost	○	△	△	×
Temperature increase of bearing	△	○	△	○
High-speed reliability	×	○	△	○
Power loss	○	○	○	×
Volume occupied by lubricator	○	△	△	×
Environmental contamination	○	△	×	△
Service life of lubricant	×	○	○	○

8.1 Grease lubrication

Grease lubrication is most usually employed because it requires no special lubricator and the use of a relatively simple housing structure is sufficient.

However, to meet machine tool bearing requirements (high-speed operation, low temperature increase, and long service life of sealed grease), the following should be taken into consideration.

8.1.1 Types of grease

In order to meet the low level temperature increase requirement of a bearings during operation, a grease low in base oil viscosity is suitable.

In general, grease NLGI 2 in consistency and approximately 10-30 mm²/s in base oil viscosity is often used for spindle bearings of machine tools. In cases where bearings are subjected to high loads, a grease with a base oil viscosity of approximately 100 mm²/s, and an extreme-pressure agent may be used to secure lubricant film during operation.

Table 8. 2 shows grease for spindle bearings of machine tools.

8.1.2 Sealing device

For spindle bearings of machine tools, it is important to use a reliable sealing device to prevent mixing of coolant, chips, wear particle of drive belt, gear lubricant, and so forth.

Where grease lubrication is adopted, contaminants have a great influence on the service life of a bearing.

An example of sealing device for grease lubrication is shown in **Fig. 8. 3**.

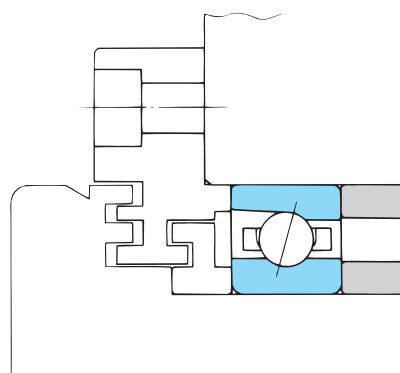

Fig. 8. 3 Example of sealing device for grease lubrication (labyrinth seal)

Table 8. 2 Grease for spindle bearings of machine tools (representative examples)

Grease name	Manufacturer	Thickener	Base oil	Base oil viscosity mm ² /s (40°C)	Application
Beacon 325	Exxon Mobil	Lithium	Diester	12	High-speed operation, low temperature
Maltemp PS 2	Kyodo oil	Lithium	Diester+mineral oil	14	
Isoflex NBU 15	NOK klüber	Barium complex	Diester+mineral oil	20	
Stabrag NBU 8 EP	NOK klüber	Barium complex	Mineral oil	105	High-load operation, wear resistance
Alvania No. 2	Showa shell sekiyu	Lithium	Mineral oil	130	

8.2 Oil lubrication

8.2.1 Oil / air lubrication

In this lubrication method, a small amount of oil of a specified quantity is supplied intermittently to each bearing by compressed air.

A schematic drawing of an oil / air lubrication system is shown in Fig. 8. 4.

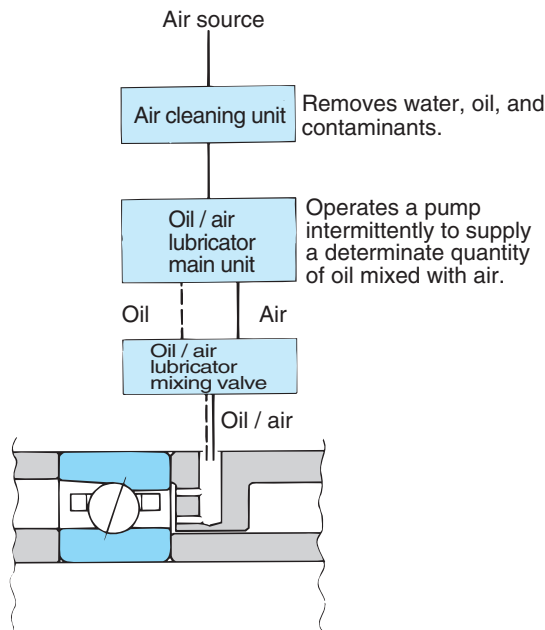

Fig. 8. 4 Oil / air lubrication system

Since oil / air lubrication has features as shown below, it has become popular in many high-speed spindle.

1. Compared with grease lubrication, oil / air lubrication allows bearings to meet the low temperature increase and high-speed operation requirements (see Fig. 8. 5).

This lubrication method eliminates concerns about the service life of lubricant as new oil is constantly supplied to the bearings. Furthermore, compressed air, which increases the pressure in the housing, is effective in preventing contaminants.

2. Compared with oil mist lubrication, oil / air lubrication is simple to adjust the quantity of oil with a high degree of accuracy. This leads to a high reliability for bearings during high-speed operation.

In addition, unlike oil mist lubrication, oil / air lubrication is free from environmental contamination and also reduces oil consumption.

3. Compared with jet lubrication, oil / air lubrication suppresses power losses of bearings (see Fig. 8. 6).

This feature saves space because a smaller drive motor and cooling unit can be used.

The structure of the main shaft can also be simple and compact.

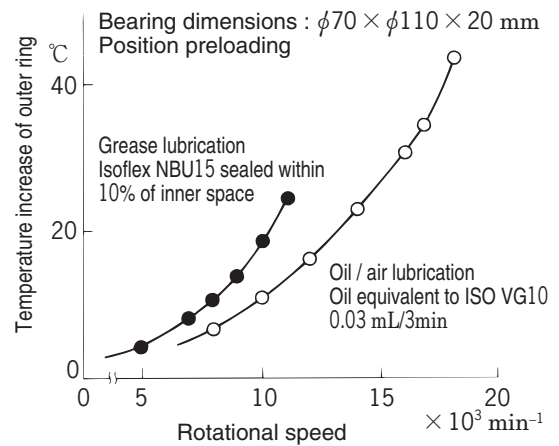

Fig. 8. 5 Comparison of the temperature increase between oil / air lubrication and grease lubrication

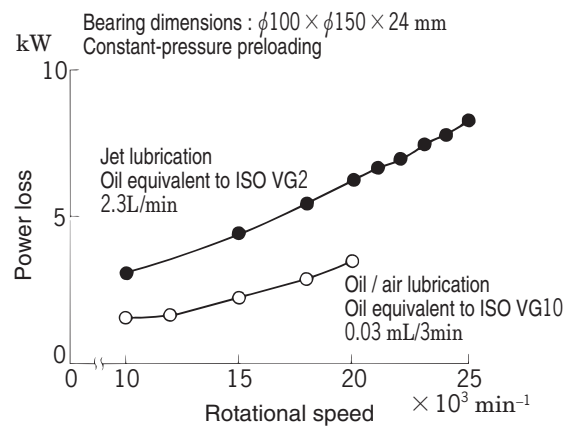

Fig. 8. 6 Comparison of power loss between oil / air lubrication and jet lubrication

In order to take advantage of oil / air lubrication features, JTEKT has produced oil / air lubricators and air cleaning units, of which we have special knowhow and have shipped to many customers.

Consult JTEKT for the application of the oil / air lubrication systems.

For details of the oil / air lubricator and air cleaning unit, see "II. Oil / Air Lubrication System."

Refer to Table 9. 4 on page 37 for information about the dimensions of the spacers for oil / air lubrication.

Refer to Supplementary table 6 on page 219 for information about the blow intervals of the oil / air.

8. 2. 2 Oil mist lubrication

Similar to oil / air lubrication, oil mist lubrication supplies a small quantity of oil to each bearing by compressed air.

Fig. 8. 7 shows an oil mist lubrication system.

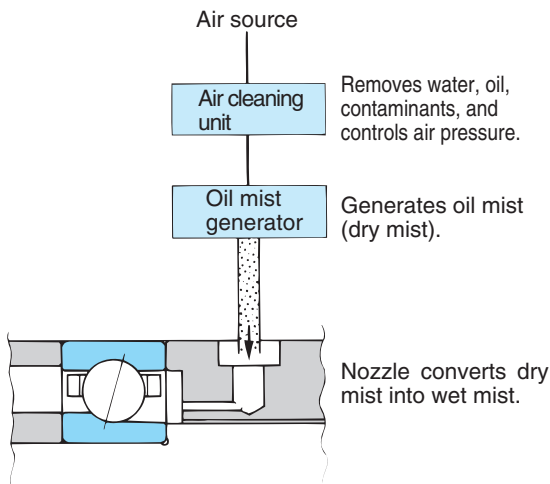

Fig. 8. 7 Oil mist lubrication system

The cost of oil mist lubrication is relatively low. The high-speed performance attained by this method is better than by grease lubrication.

To obtain maximum performance from this method, due consideration should be given to the following.

1. Oil quantity settings

The quantity of oil is set by the rate at which the oil mist generator produces oil drops. Since the rate of oil turned to mist depends on the type of oil, air pressure, flow rate, etc., it is important to determine the amount of oil drops required after the characteristics of the whole system have been sufficiently understood.

2. Distribution of mist to several bearings

In general, a single oil mist generator is used to distribute the mist to several bearings.

Each bearing should be checked to see if it is supplied with an adequate quantity of oil.

3. Installation of suitable nozzle(s)

The nozzle converts dry mist into wet mist suitable for lubrication of bearings and supplies mist to the inside of bearings.

For reliable operation, the nozzle design should be given sufficient consideration.

A well-designed nozzle reduces the quantity of oil so that contamination by oil mist will also be reduced.

8. 2. 3 Jet lubrication

Jet lubrication is a method in which a large quantity of lubricant is injected at a high velocities through the bearing side to lubricate and cool the bearing simultaneously.

Fig. 8. 8 shows a jet lubrication system.

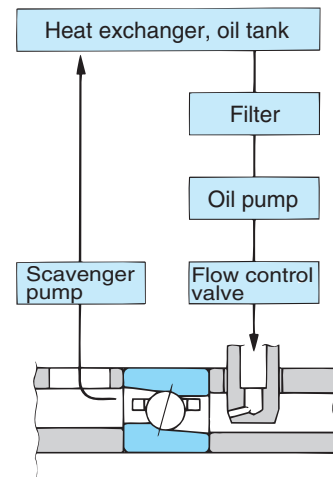

Fig. 8. 8 Jet lubrication system

Owing to its high reliability for high-speed operation, the jet lubrication is often applied to such bearings designed for high-speed and high-temperature operation, for example, gas turbine engines. Also, jet lubrication is sometimes employed for the high-speed spindles of machine tools. If this is the case, give due consideration to the following points.

1. Use oil of extremely low viscosity of approximately $2 \text{ mm}^2/\text{s}$ to restrain power loss and temperature increase.
2. To improve cooling efficiency, set the velocity of the lubricant ejected from the nozzle to at least 20% of the peripheral speed of the outer surface of the inner ring, thereby allowing more oil to pass through the bearing.
Installing several nozzles on the circumference for a larger quantity of oil is also effective to some degree.
3. A pump or similar device should be used to discharge oil smoothly. For this reason, the discharge port should be as large as possible to ensure a smooth discharge of oil.
After discharge, the lubricant should be cooled with a heat exchanger of adequate capacity in order to minimize temperature changes.
It is also essential to maintain clean lubricant by installing an appropriate filter, ensuring an airtight oil tank, and so forth.

9. Designing peripheral parts of bearings

9.1 Tolerances of shafts and housings

When the inner and outer rings of a bearing are mounted on a shaft and a housing with a certain interference, the shapes of the shaft and housing tend to influence the raceway surface of the bearing leading to a change in running accuracy.

Therefore, shafts and housings need to be finished

to maximum possible precision.

Recommended values for tolerances and surface roughness of shafts and housings are shown in **Tables 9.1** and **9.2**.

Refer to "III. **Handling of Bearings**" for details about handling and mounting of the bearings.

Table 9.1 Tolerances and surface roughness of shafts

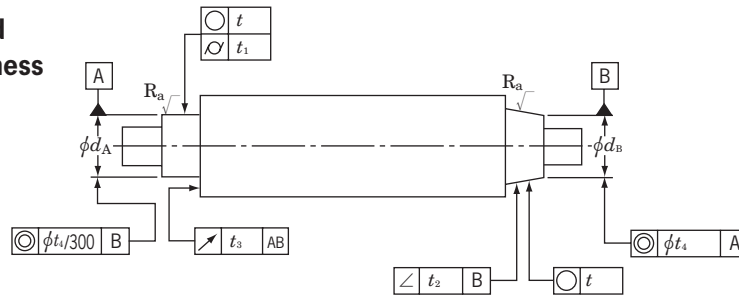

Unit : μm

Shaft diameter (mm)		Roundness(\bigcirc)		Cylindricity(ϕ)		Inclination(\angle)		Deflection(\nearrow)		Coaxiality(\odot)		Roughness	
		t		t_1		t_2		t_3		t_4		R_a	
		Tolerance class of bearing		Tolerance class of bearing		Tolerance class of bearing		Tolerance class of bearing		Tolerance class of bearing		Tolerance class of bearing	
over	up to	Class 5	Classes 4, 2	Class 5	Classes 4, 2	Classes 4, 2	Class 5	Classes 4, 2	Class 5	Classes 4, 2	Class 5	Classes 4, 2	
18	30	2	1.2	2	1.2	2		4	9	6	0.2	0.1	
30	50	2	1.2	2	1.2	2		4	11	7	0.2	0.1	
50	80	2.5	1.5	2.5	1.5	2.5		5	13	8	0.2	0.1	
80	120	3	2	3	2	3		6	15	10	0.4	0.2	
120	180	4	2.5	4	2.5	4		8	18	12	0.4	0.2	
180	250	5	3.5	5	3.5	5		10	20	14	0.4	0.2	
250	315	6	4	6	4	6		12	23	16	0.4	0.2	
315	400	6.5	4.5	6.5	4.5	6.5		13	25	18	0.4	0.2	

- [Remarks]
1. Tolerances, symbols, and reference planes for shafts comply with ISO/R1101.
 2. When determining the tolerance in relation to the permissible accuracy of shapes, the shaft diameters d_A and d_B are used as reference dimensions.

Table 9.2 Tolerances and surface roughness of housings

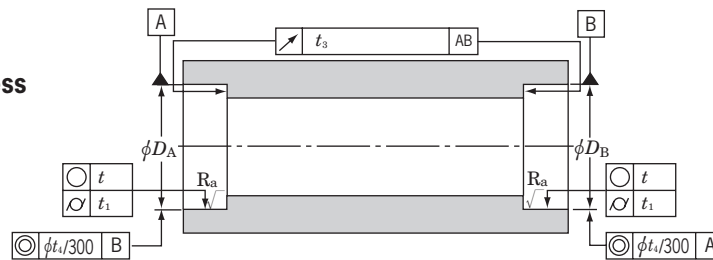

Unit : μm

Housing bore diameter (mm)		Roundness(\bigcirc)		Cylindricity(ϕ)		Deflection(\nearrow)		Coaxiality(\odot)		Roughness	
		t		t_1		t_3		t_4		R_a	
		Tolerance class of bearing		Tolerance class of bearing		Tolerance class of bearing		Tolerance class of bearing		Tolerance class of bearing	
over	up to	Class 5	Classes 4, 2	Class 5	Classes 4, 2	Class 5	Classes 4, 2	Class 5	Classes 4, 2	Class 5	Classes 4, 2
18	30	2	1.2	2	1.2		4	9	6	0.3	0.1
30	50	2	1.2	2	1.2		4	11	7	0.3	0.1
50	80	2.5	1.5	2.5	1.5		5	13	8	0.4	0.2
80	120	3	2	3	2		6	15	10	0.8	0.4
120	180	4	2.5	4	2.5		8	18	12	0.8	0.4
180	250	5	3.5	5	3.5		10	20	14	0.8	0.4
250	315	6	4	6	4		12	23	16	1.6	0.8
315	400	6.5	4.5	6.5	4.5		13	25	18	1.6	0.8
400	500	7.5	5	7.5	5		15	27	20	1.6	0.8
500	630	8	5.5	8	5.5		16	30	22	1.6	0.8

- [Remarks]
1. Tolerances, symbols, and reference planes for housings comply with ISO/R1101.
 2. When determining the tolerance in relation to the permissible accuracy of shapes, the housing bore diameters D_A and D_B are used as reference dimensions.

9.2 Limits of chamfer dimensions and fillet radii of shafts and housings

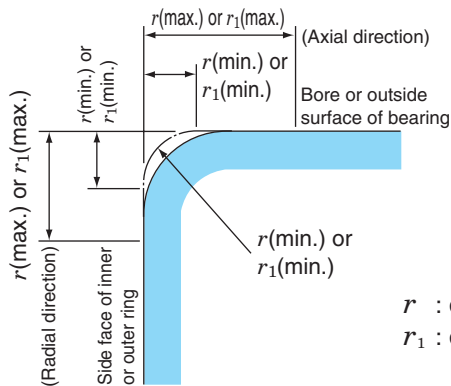

[Remark]

An imaginary arc with a radius of r (min) is defined as being tangent to both the side face of the inner ring and the bore surface of the bearing; or to both the side face of outer ring and the outside surface of the bearing. Although an exact shape is not specified for chamfered surfaces, the outline in the axial plane shall not extend beyond the imaginary arc.

r : dimension for chamfering inner and outer rings

r_1 : dimension for chamfering the front and the likes of the inner and outer rings

Table 9.3 Limits of chamfer dimensions and fillet radii of shafts and housings

(1) Radial bearings (not applicable to tapered roller bearings)

Unit : mm

r (min.) or r_1 (min.)	Nominal bore diameter d (mm)		r (max.) or r_1 (max.)		(Refer.) Fillet radius of shaft or housing r_a
	over	up to	Radial direction	Axial ¹⁾ direction	max.
0.05	—	—	0.1	0.2	0.05
0.08	—	—	0.16	0.3	0.08
0.1	—	—	0.2	0.4	0.1
0.15	—	—	0.3	0.6	0.15
0.2	—	—	0.5	0.8	0.2
0.3	—	40	0.6	1	0.3
	40	—	0.8	1	
0.6	—	40	1	2	0.6
	40	—	1.3	2	
1	—	50	1.5	3	1
	50	—	1.9	3	
1.1	—	120	2	3.5	1
	120	—	2.5	4	
1.5	—	120	2.3	4	1.5
	120	—	3	5	
2	—	80	3	4.5	2
	80	220	3.5	5	
	220	—	3.8	6	
2.1	—	280	4	6.5	2
	280	—	4.5	7	
2.5	—	100	3.8	6	2
	100	280	4.5	6	
	280	—	5	7	
3	—	280	5	8	2.5
	280	—	5.5	8	
4	—	—	6.5	9	3
5	—	—	8	10	4
6	—	—	10	13	5
7.5	—	—	12.5	17	6
9.5	—	—	15	19	8
12	—	—	18	24	10
15	—	—	21	30	12
19	—	—	25	38	15

[Note] 1) For bearings 2mm or less in nominal width, the value of r (max.) in the axial direction shall be the same as that in the radial direction.

(2) Metric tapered roller bearings

Unit : mm

r (min.) or r_1 (min.) ²⁾	Nominal bore ¹⁾ or nominal outside diameter d or D (mm)		r (max.) or r_1 (max.)		(Refer.) Fillet radius of shaft or housing r_a
	over	up to	Radial direction	Axial direction	max.
0.3	—	40	0.7	1.4	0.3
	40	—	0.9	1.6	
0.6	—	40	1.1	1.7	0.6
	40	—	1.3	2	
1	—	50	1.6	2.5	1
	50	—	1.9	3	
1.5	—	120	2.3	3	1.5
	120	250	2.8	3.5	
	250	—	3.5	4	
2	—	120	2.8	4	2
	120	250	3.5	4.5	
	250	—	4	5	
2.5	—	120	3.5	5	2
	120	250	4	5.5	
	250	—	4.5	6	
3	—	120	4	5.5	2.5
	120	250	4.5	6.5	
	250	400	5	7	
	400	—	5.5	7.5	
4	—	120	5	7	3
	120	250	5.5	7.5	
	250	400	6	8	
	400	—	6.5	8.5	
5	—	180	6.5	8	4
	180	—	7.5	9	
6	—	180	7.5	10	5
	180	—	9	11	
7.5	—	—	12.5	17	6
9.5	—	—	15	19	8

[Notes] 1) Inner rings are classified by d , outer rings, by D .

2) Values in italics comply with JTEKT standards.

9.3 Spacers for oil / air lubrication

The dimensions of the spacers for oil / air lubrication are shown in **Table 9. 4**.

Table 9. 4(1) Dimensions of the spacers for oil / air lubrication Angular contact ball bearings

7000 series

7200 series

7900 series

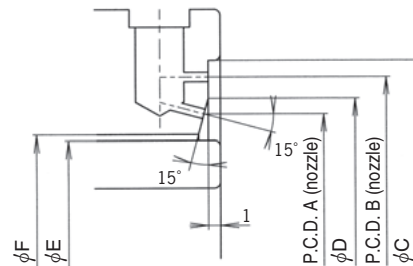

Nozzle diameter

7000, 7200 series		7900 series	
Bore dia. No.	Nozzle diameter (φ)	Bore dia. No.	Nozzle diameter (φ)
00-09	0.8	00-10	0.8
10-40	1.0	11-40	1.0

Unit : mm

Bore dia. No.	Nominal bore dia.	7000 series						7200 series						7900 series					
		A	B	C	D	E	F	A	B	C	D	E	F	A	B	C	D	E	F
00	10	15.2	20.7	23.5	18.0	11.5	12.5	18.2	23.5	26.3	20.9	14.5	15.5	14.7	18.1	20.9	16.4	11.0	12.0
01	12	18.4	23.8	26.6	21.1	14.7	15.7	19.0	25.9	28.7	22.5	15.3	16.3	16.7	20.1	22.9	18.4	13.0	14.0
02	15	21.3	26.7	29.5	24.0	17.6	18.6	22.8	29.4	32.2	26.1	19.1	20.1	19.7	24.0	26.8	21.9	16.0	17.0
03	17	24.6	29.8	32.6	27.2	20.9	21.9	25.8	33.4	36.2	29.6	22.1	23.1	21.7	26.0	28.8	23.9	18.0	19.0
04	20	28.5	35.8	38.6	32.2	24.8	25.8	30.5	39.6	42.4	35.1	26.8	27.8	26.2	31.8	34.6	29.0	22.5	23.5
05	25	33.0	40.2	43.0	36.6	29.3	30.3	35.3	44.1	46.9	39.7	31.6	32.6	32.0	37.3	40.1	34.7	28.3	29.3
06	30	39.0	47.1	49.9	43.1	35.3	36.3	41.7	52.7	55.5	47.2	38.0	39.0	36.3	41.7	44.5	39.0	32.6	33.6
07	35	45.0	54.0	56.8	49.5	41.3	42.3	48.3	61.3	64.1	54.8	44.6	45.6	41.7	48.4	51.2	45.1	38.0	39.0
08	40	50.5	59.3	62.1	54.9	46.8	47.8	53.2	67.0	69.8	60.1	49.5	50.5	47.9	54.8	57.6	51.4	44.2	45.2
09	45	55.4	65.4	68.2	60.4	51.7	52.7	56.8	71.7	74.5	64.3	53.1	54.1	53.2	60.9	63.7	57.1	49.5	50.5
10	50	60.9	70.9	73.9	65.9	57.0	58.0	63.5	78.1	81.1	70.8	59.6	60.6	57.7	65.3	68.1	61.5	54.0	55.0
11	55	66.8	78.7	81.7	72.8	62.9	63.9	70.7	87.6	90.6	79.2	66.8	67.8	64.1	72.1	74.9	68.1	60.2	61.2
12	60	71.9	83.9	86.9	77.9	68.0	69.0	77.7	96.6	99.6	87.2	73.8	74.8	68.8	77.5	80.5	73.2	64.9	65.9
13	65	77.2	89.0	92.0	83.1	73.3	74.3	82.4	102.5	105.5	92.5	78.5	79.5	73.8	82.1	85.1	78.0	69.9	70.9
14	70	83.3	97.2	100.2	90.3	79.4	80.4	87.2	108.0	111.0	97.6	83.3	84.3	80.8	90.4	93.4	85.6	76.9	77.9
15	75	88.3	102.1	105.1	95.2	84.4	85.4	91.7	113.5	116.5	102.6	87.8	88.8	85.6	95.0	98.0	90.3	81.7	82.7
16	80	94.7	110.5	113.5	102.6	90.8	91.8	98.7	121.5	124.5	110.1	94.8	95.8	92.3	100.3	103.3	96.3	88.4	89.4
17	85	100.8	116.5	119.5	108.7	96.9	97.9	105.2	130.0	133.0	117.6	101.3	102.3	101.1	108.7	111.7	104.9	97.2	98.2
18	90	106.1	123.8	126.8	115.0	102.2	103.2	111.7	138.5	141.5	125.1	107.8	108.8	104.2	113.7	116.7	109.0	100.3	101.3
19	95	119.6	130.7	133.7	125.2	115.7	116.7	118.3	146.9	149.9	132.6	114.4	115.4	107.0	118.4	121.4	112.7	103.1	104.1
20	100	121.0	132.4	135.4	126.7	117.1	118.1	125.8	156.4	159.4	141.1	121.9	122.9	112.9	127.3	130.3	120.1	109.0	110.0
21	105	125.1	144.2	147.2	134.7	121.2	122.2	144.6	165.4	168.4	155.0	140.7	141.7	120.7	132.4	135.4	126.6	116.8	117.8
22	110	129.7	151.0	154.0	140.4	125.8	126.8	150.7	171.8	174.6	161.3	146.8	147.8	123.2	137.3	140.3	130.3	119.3	120.3
24	120	138.5	161.0	164.0	149.8	134.6	135.6	163.3	186.7	189.7	175.0	159.4	160.4	137.5	150.7	153.7	144.1	133.6	134.6
26	130	153.5	177.0	180.0	165.3	149.6	150.6	174.7	199.4	202.4	187.1	170.8	171.8	149.4	164.2	167.2	156.8	145.5	146.5
28	140	171.7	187.1	190.1	179.4	167.8	168.8	178.1	214.7	217.7	196.4	174.2	175.2	159.4	174.2	177.2	166.8	155.5	156.5
30	150	174.8	200.5	203.5	187.7	170.9	171.9	191.4	231.7	234.7	211.6	187.5	188.5	170.6	191.2	194.2	180.9	166.7	167.7
32	160	188.2	213.7	216.7	201.0	184.3	185.3	207.4	245.7	248.7	226.6	203.5	204.5	180.7	201.2	204.2	191.0	176.8	177.8
34	170	201.7	231.0	234.0	216.4	197.8	198.8	220.8	262.6	265.6	241.7	216.9	217.9	190.7	211.2	214.2	201.0	186.8	187.8
36	180	215.0	247.8	250.8	231.4	211.1	212.1	229.0	274.5	277.5	251.8	225.1	226.1	204.1	228.1	231.1	216.1	200.2	201.2
38	190	225.1	257.9	260.9	241.5	221.2	222.2	244.1	289.5	292.5	266.8	240.2	241.2	214.1	238.1	241.1	226.1	210.2	211.2
40	200	238.5	274.8	277.8	256.7	234.6	235.6	257.3	306.3	309.3	281.8	253.4	254.4	227.5	255.0	258.0	241.3	223.6	224.6

* Commonly used in contact angles of 15° and 30°.

**Table 9. 4(2) Dimensions of the spacers for oil / air lubrication
Angular contact ball bearings**

HAR000 series

HAR900 series

3NCHAR000 series

3NCHAR900 series

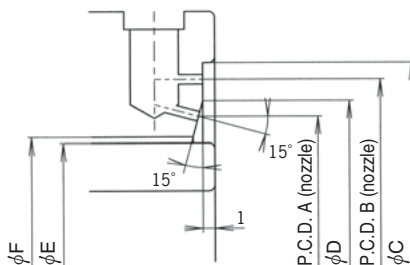

Nozzle diameter

HAR000, 3NCHAR000 series		HAR900, 3NCHAR900 series	
Bore dia. No.	Nozzle diameter (φ)	Bore dia. No.	Nozzle diameter (φ)
06-10	0.8	08-10	0.8
11-34	1.0	11-34	1.0

Unit : mm

Bore dia. No.	Nominal bore dia.	HAR000, 3NCHAR000 series						HAR900, 3NCHAR900 series					
		A	B	C	D	E	F	A	B	C	D	E	F
06	30	39.7	45.9	48.7	42.8	36.0	37.0	—	—	—	—	—	—
07	35	45.6	51.9	54.7	48.8	41.9	42.9	—	—	—	—	—	—
08	40	51.4	57.4	60.2	54.4	47.7	48.7	49.1	53.7	56.5	51.4	45.4	46.4
09	45	57.0	63.6	66.4	60.3	53.3	54.3	54.6	59.2	62.0	56.9	50.9	51.9
10	50	62.5	68.6	71.6	65.6	58.6	59.6	58.8	64.1	66.9	61.5	55.1	56.1
11	55	69.7	76.6	79.6	73.2	65.8	66.8	65.3	70.6	73.6	68.0	61.4	62.4
12	60	74.7	81.6	84.6	78.2	70.8	71.8	70.3	75.6	78.6	73.0	66.4	67.4
13	65	79.4	86.6	89.6	83.0	75.5	76.5	75.1	80.9	83.9	78.0	71.2	72.2
14	70	86.2	95.0	98.0	90.6	82.3	83.3	82.6	88.6	91.6	85.6	78.7	79.7
15	75	91.2	99.9	102.9	95.6	87.3	88.3	88.5	93.6	96.6	91.1	84.6	85.6
16	80	98.1	107.9	110.9	103.0	94.2	95.2	93.5	98.6	101.6	96.1	89.6	90.6
17	85	104.0	112.9	115.9	108.5	100.1	101.1	100.7	106.5	109.5	103.6	96.8	97.8
18	90	110.7	121.4	124.4	116.1	106.8	107.8	104.7	111.5	114.5	108.1	100.8	101.8
19	95	115.7	126.4	129.4	121.1	111.8	112.8	110.7	116.5	119.5	113.6	106.8	107.8
20	100	119.4	131.3	134.3	125.4	115.5	116.5	116.4	124.9	127.9	120.7	112.5	113.5
21	105	127.6	139.1	142.1	133.4	123.7	124.7	122.6	129.9	132.9	126.3	118.7	119.7
22	110	136.5	147.3	150.3	141.9	132.6	133.6	127.6	134.9	137.9	131.3	123.7	124.7
24	120	146.5	157.3	160.3	151.9	142.6	143.6	139.9	147.9	150.9	143.9	136.0	137.0
26	130	160.7	173.7	176.7	167.2	156.8	157.8	152.2	160.9	163.9	156.6	148.3	149.3
28	140	170.7	183.7	186.7	177.2	166.8	167.8	162.2	170.9	173.9	166.6	158.3	159.3
30	150	182.7	197.2	200.2	190.0	178.8	179.8	176.5	187.3	190.3	181.9	172.6	173.6
32	160	195.1	210.2	213.2	202.7	191.2	192.2	186.5	197.3	200.3	191.9	182.6	183.6
34	170	209.6	226.1	229.1	217.9	205.7	206.7	196.5	207.3	210.3	201.9	192.6	193.6

* Commonly used in contact angles of 15°, 20° and 30°.

**Table 9. 4(3) Dimensions of the spacers for oil / air lubrication
Angular contact ball bearings**

3NCHAC000 series

3NCHAC900 series

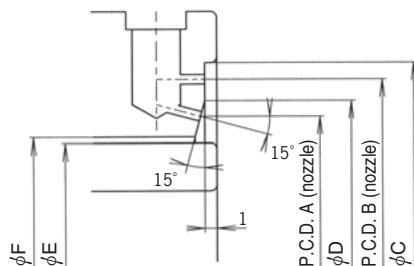

Nozzle diameter

3NCHAC000 series		3NCHAC900 series	
Bore dia. No.	Nozzle diameter (ϕ)	Bore dia. No.	Nozzle diameter (ϕ)
00-09	0.8	00-10	0.8
10-34	1.0	11-34	1.0

Unit : mm

Bore dia. No.	Nominal bore dia.	3NCHAC000 series						3NCHAC900 series					
		A	B	C	D	E	F	A	B	C	D	E	F
00	10	15.7	20.7	23.5	18.2	12.0	13.0	15.0	18.1	20.9	16.6	11.3	12.3
01	12	18.8	23.8	26.6	21.3	15.1	16.1	16.7	20.1	22.9	18.4	13.0	14.0
02	15	21.8	26.7	29.5	24.3	18.1	19.1	20.0	24.0	26.8	22.0	16.3	17.3
03	17	25.1	29.8	32.6	27.5	21.4	22.4	22.3	26.0	28.8	24.2	18.6	19.6
04	20	29.1	35.8	38.6	32.5	25.4	26.4	26.6	31.8	34.6	29.2	22.9	23.9
05	25	33.6	40.2	43.0	36.9	29.9	30.9	32.4	37.3	40.1	34.9	28.7	29.7
06	30	39.7	47.1	49.9	43.4	36.0	37.0	36.8	41.7	44.5	39.3	33.1	34.1
07	35	45.8	54.0	56.8	49.9	42.1	43.1	42.2	48.4	51.2	45.3	38.5	39.5
08	40	51.2	59.3	62.1	55.3	47.5	48.5	48.5	54.8	57.6	51.7	44.8	45.8
09	45	56.2	65.4	68.2	60.8	52.5	53.5	53.8	60.9	63.7	57.4	50.1	51.1
10	50	61.7	70.9	73.9	66.3	57.8	58.8	58.2	65.3	68.1	61.8	54.5	55.5
11	55	67.7	78.7	81.7	73.2	63.8	64.8	64.7	72.1	74.9	68.4	61.0	62.0
12	60	72.8	83.9	86.9	78.4	68.9	69.9	69.5	77.5	80.5	73.5	65.6	66.6
13	65	78.1	89.0	92.0	83.6	74.2	75.2	74.1	82.1	85.1	78.1	70.2	71.2
14	70	84.4	97.2	100.2	90.8	80.5	81.5	81.6	90.4	93.4	86.0	77.7	78.7
15	75	89.4	102.1	105.1	95.8	85.5	86.5	86.4	95.0	98.0	90.7	82.5	83.5
16	80	96.0	110.5	113.5	103.3	92.1	93.1	91.5	100.3	103.3	95.9	87.6	88.6
17	85	102.0	116.5	119.5	109.3	98.1	99.1	100.0	108.4	111.4	104.2	96.1	97.1
18	90	107.5	123.8	126.8	115.7	103.6	104.6	103.2	113.7	116.7	108.5	99.3	100.3
19	95	119.6	130.7	133.7	125.2	115.7	116.7	107.9	118.4	121.4	113.2	104.0	105.0
20	100	117.8	134.0	137.0	125.9	113.9	114.9	114.0	127.3	130.3	120.7	110.1	111.1
21	105	126.7	144.2	147.2	135.5	122.8	123.8	121.8	132.3	135.3	127.1	117.9	118.9
22	110	131.4	151.0	154.0	141.2	127.5	128.5	124.3	137.3	140.3	130.8	120.4	121.4
24	120	140.2	161.0	164.0	150.6	136.3	137.3	138.9	150.8	153.8	144.9	135.0	136.0
26	130	155.4	177.0	180.0	166.2	151.5	152.5	151.2	164.5	167.5	157.9	147.3	148.3
28	140	169.7	187.1	190.1	178.4	165.8	166.8	157.8	174.3	177.3	166.1	153.9	154.9
30	150	177.5	200.5	203.5	189.0	173.6	174.6	171.8	191.2	194.2	181.5	167.9	168.9
32	160	193.8	214.0	217.0	203.9	189.9	190.9	185.0	201.2	204.2	193.1	181.1	182.1
34	170	207.8	230.7	233.7	219.3	203.9	204.9	195.0	211.2	214.2	203.1	191.1	192.1

* Commonly used in contact angles of 15° and 20° .

**Table 9. 4(4) Dimensions of the spacers for oil / air lubrication
Angular contact ball bearings**

3NCHAD000 series

Unit : mm

Bore dia. No.	Nominal bore dia.	3NCHAD000 series				
		A	B	C	D	E
07	35	41.3	54.7	43.3	39.1	39.7
08	40	46.4	60.2	48.6	44.2	44.8
09	45	52.2	66.4	54.4	49.6	50.2
10	50	57.2	71.6	59.4	54.6	55.2
11	55	63.8	79.6	66.3	61.0	61.6
12	60	68.8	84.6	71.3	66.0	66.6
13	65	73.8	89.6	76.3	71.0	71.6
14	70	79.6	98.0	82.4	76.8	77.4
15	75	84.6	102.9	87.4	81.8	82.4
16	80	91.7	110.9	94.4	87.9	89.5
17	85	96.7	115.9	99.4	92.9	94.5
18	90	101.9	124.4	105.2	98.1	99.7
19	95	106.9	129.4	110.2	103.1	104.7
20	100	112.7	134.3	115.6	107.5	109.7
21	105	119.3	142.1	122.4	114.1	116.3
22	110	125.6	150.3	129.0	120.4	122.6
24	120	135.6	160.3	139.0	130.4	132.6
26	130	148.4	176.7	152.1	141.6	145.4

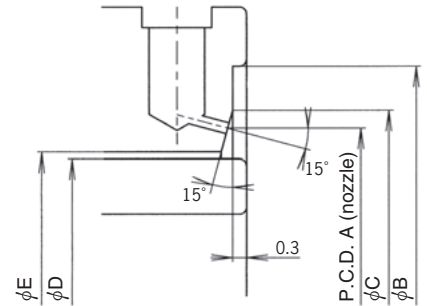

Nozzle diameter

3NCHAD000 series	
Bore dia. No.	Nozzle diameter (φ)
07-10	0.8
11-26	1.0

**Table 9. 4(5) Dimensions of the spacers for oil / air lubrication
Angular contact ball bearings**

3NCHAF000 series

3NCHAF900 series

Unit : mm

Bore dia. No.	Nominal bore dia.	3NCHAF000 series						3NCHAF900 series						
		A	B	C	D	E	F	A	B	C	D	E	F	
06	30	38.0	44.4	47.2	41.2	34.3	35.3	—	—	—	—	—	—	—
07	35	44.0	50.4	53.2	47.2	40.3	41.3	—	—	—	—	—	—	—
08	40	49.1	55.4	58.2	52.3	45.4	46.4	47.2	52.2	55.0	49.7	43.5	44.5	—
09	45	54.9	61.6	64.4	58.3	51.2	52.2	52.7	57.7	60.5	55.2	49.0	50.0	—
10	50	59.9	66.6	69.4	63.3	56.2	57.2	57.2	63.1	65.9	60.2	53.5	54.5	—
11	55	66.5	74.1	77.1	70.3	62.6	63.6	63.2	69.1	72.1	66.2	59.3	60.3	—
12	60	71.5	79.1	82.1	75.3	67.6	68.6	68.2	74.1	77.1	71.2	64.3	65.3	—
13	65	76.4	83.8	86.8	80.1	72.5	73.5	73.0	79.4	82.4	76.2	69.1	70.1	—
14	70	82.5	92.0	95.0	87.3	78.6	79.6	79.9	86.6	89.6	83.3	76.0	77.0	—
15	75	87.5	97.0	100.0	92.3	83.6	84.6	84.9	91.6	94.6	88.3	81.0	82.0	—
16	80	94.0	104.4	107.4	99.2	90.1	91.1	89.9	96.6	99.6	93.3	86.0	87.0	—
17	85	99.0	109.4	112.4	104.2	95.1	96.1	95.9	103.5	106.5	99.7	92.0	93.0	—
18	90	105.1	117.4	120.4	111.3	101.2	102.2	100.9	108.5	111.5	104.7	97.0	98.0	—
19	95	110.1	122.4	125.4	116.3	106.2	107.2	105.9	113.5	116.5	109.7	102.0	103.0	—
20	100	115.1	127.4	130.4	121.3	111.2	112.2	111.9	121.4	124.4	116.7	108.0	109.0	—
21	105	121.7	134.8	137.8	128.3	117.8	118.8	116.9	126.4	129.4	121.7	113.0	114.0	—
22	110	128.3	142.3	145.3	135.3	124.4	125.4	121.9	131.4	134.4	126.7	118.0	119.0	—
24	120	—	—	—	—	—	—	133.0	143.4	146.4	138.2	129.1	130.1	—
26	130	—	—	—	—	—	—	144.6	155.9	158.9	150.3	140.7	141.7	—

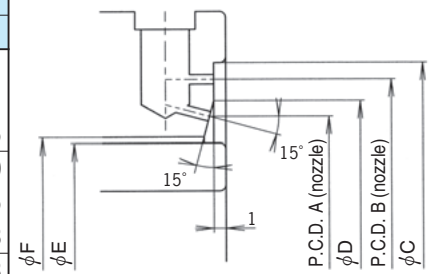

Nozzle diameter

3NCHAF000 series		3NCHAF900 series	
Bore dia. No.	Nozzle diameter (φ)	Bore dia. No.	Nozzle diameter (φ)
06-10	0.8	08-10	0.8
11-22	1.0	11-26	1.0

**Table 9. 4(6) Dimensions of the spacers for oil / air lubrication
Cylindrical Roller bearings**

NN3000 series

N1000 series

3NCN1000 series

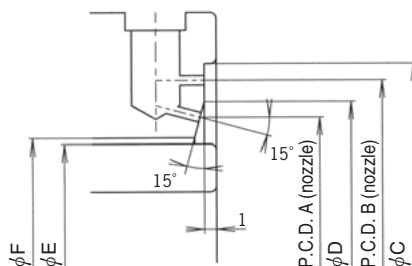

Nozzle diameter

NN3000 series		N1000, 3NCN1000 series	
Bore dia. No.	Nozzle diameter (φ)	Bore dia. No.	Nozzle diameter (φ)
05-09	0.8	06-10	0.8
10-40	1.0	11-32	1.0

Unit : mm

Bore dia. No.	Nominal bore dia.	NN3000 series						N1000, 3NCN1000 series						
		A	B	C	D	E	F	A	B	C	D	E	F	
05	25	34.9	40.7	41.9	37.7	31.9	32.9	—	—	—	—	—	—	—
06	30	40.6	47.4	48.6	43.4	37.5	38.5	40.7	47.3	48.6	43.5	37.5	38.5	—
07	35	47.4	53.9	55.1	50.1	44.0	45.0	47.0	53.7	55.2	49.8	44.0	45.0	—
08	40	53.6	60.0	61.2	56.4	50.0	51.0	54.0	60.0	61.4	56.8	50.0	51.0	—
09	45	58.5	66.2	67.4	61.3	54.5	55.5	58.1	67.2	68.8	60.9	53.5	54.5	—
10	50	63.4	71.1	72.3	66.2	59.5	60.5	62.1	71.2	72.8	64.9	57.5	58.5	—
11	55	70.5	79.5	80.8	73.3	66.0	67.0	71.1	79.7	81.6	73.9	66.0	67.0	—
12	60	75.5	84.5	85.9	78.3	71.1	72.1	76.2	84.8	86.6	79.0	71.1	72.1	—
13	65	80.5	89.5	91.0	83.3	76.0	77.0	80.5	89.2	91.1	83.3	75.5	76.5	—
14	70	88.2	98.2	100.0	91.2	83.0	84.0	88.6	98.5	100.8	91.4	83.0	84.0	—
15	75	93.2	103.3	105.0	96.2	88.0	89.0	93.8	103.5	105.8	96.8	88.0	89.0	—
16	80	100.0	110.8	113.0	103.0	94.0	95.0	100.7	111.4	113.9	103.7	94.0	95.0	—
17	85	105.0	115.8	118.0	108.0	99.0	100.0	105.4	116.4	118.8	108.4	99.0	100.0	—
18	90	112.6	124.5	127.0	115.6	106.0	107.0	112.7	125.2	128.1	115.7	106.0	107.0	—
19	95	117.5	129.5	132.0	120.5	111.0	112.0	117.7	130.2	132.8	120.7	111.0	112.0	—
20	100	122.5	134.5	137.0	125.5	116.0	117.0	120.1	135.5	139.8	123.1	114.0	115.0	—
21	105	128.3	143.0	146.4	131.3	121.4	122.4	125.8	142.5	147.5	128.8	119.9	120.9	—
22	110	136.4	152.0	155.2	139.4	128.4	129.4	135.8	151.5	156.0	138.8	128.4	129.4	—
24	120	146.4	162.0	165.2	149.4	138.4	139.4	143.3	162.3	167.8	146.3	136.4	137.4	—
26	130	160.4	178.5	182.6	163.4	151.4	152.4	159.8	179.3	183.8	162.8	149.4	150.4	—
28	140	170.5	188.5	192.8	173.5	161.4	162.4	167.7	187.0	193.8	170.7	159.4	160.4	—
30	150	183.2	202.4	206.8	186.2	173.4	174.4	179.9	202.0	209.3	182.9	170.9	171.9	—
32	160	192.9	214.0	219.8	195.9	182.4	183.4	191.0	218.5	223.8	194.0	181.4	182.4	—
34	170	207.2	230.0	237.0	210.2	195.4	196.4	—	—	—	—	—	—	—
36	180	221.6	248.3	256.2	224.6	208.4	209.4	—	—	—	—	—	—	—
38	190	229.5	259.0	266.2	232.5	216.4	217.4	—	—	—	—	—	—	—
40	200	248.0	276.0	283.4	251.0	233.4	234.4	—	—	—	—	—	—	—

10. High Ability angular contact ball bearings



High Ability angular contact ball bearings are optimized for use on machine-tool spindles. They excel in high-speed performance and rapid acceleration/deceleration, and are especially superior





in ultrahigh-speed applications when used with oil / air lubrication. Even with grease lubrication, these bearings are superior to conventional products in high-speed applications.

10.1 Types and applications

High Ability angular contact bearings are available in the varieties listed in **Table 10. 1**, all of which differ in structure and rolling-element material.

Select the type that is best suited for the application.

Table 10. 1 High Ability bearing types and principal applications

Principal applications	Type	Specification		
		Bearing dimension series	Contact angle	Material of rolling element
High-speed, high-rigidity type	Type R 	10 19	15° 20° 30°	Steel or ceramics
High-speed, high load-rating type	Type C 	10 19	15° 20°	ceramics
Ultrafast, low-noise type for oil / air lubrication	Type D 	10	20°	ceramics
Extremely ultrafast type for oil / air lubrication	Type F 	10 19	20°	ceramics

10.2 Features

● **20 to 30% reduction in temperature increase (compared with JTEKT's conventional products)**

JTEKT has conducted various tests and analyses and developed elaborate machining techniques to improve the performance of bearings used with machining tool spindles. The result is a substantial reduction in frictional heat generated in bearings rotating at a high speed.

● **1.2- to 1.5-time increases in speed limits (compared with JTEKT's conventional products)**

Speed limits have been extended through re-designing for high-speed rotation and heat reduction. Use of ceramic balls as rolling elements enables additional high-speed rotation.

● **Improved high-speed performance achieved by position preloading**

Low increases in temperature during operation ensure reduced changes in preload. Preload can be given by position preloading even at high speeds, which has been hitherto unavailable with conventional systems. The result is high-precision machining with stability.

● **Conventional bearings easily replaced**

Dimensions of High Ability bearings conform to ISO standards. Replacement of conventional bearings with High Ability bearings requires minimal geometry changes of the present spindle or housing.

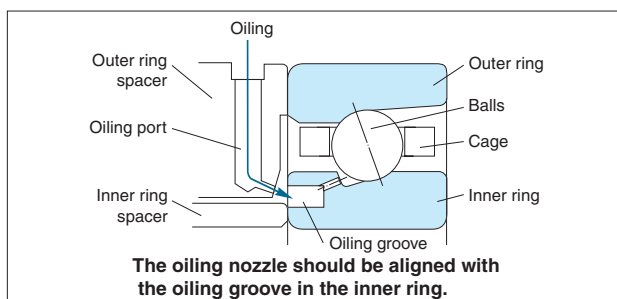

Fig. 10. 1 Lubrication method for Type D

High Ability Type D bearings are designed for oil / air lubrication. Their inner rings have an oiling groove to ensure lubrication on the rolling contact surface for improved lubrication reliability.

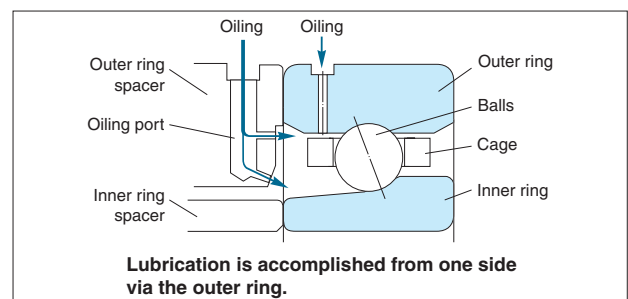

Fig. 10. 2 Lubrication method used in Type F

The oiling port in Type F is provided at its outer ring to ensure improved lubrication reliability on the guide ways of the cage. High Ability Type F bearings deliver the best high-speed performance.

10.3 Performance

High Ability bearings exhibit their maximum performance when used in pairs or when more than two units are combined and when preload is given by position preloading. Shown below is the operating performance of High Ability bearings with preload given by position preloading.

1) Performance of Types R and C

Fig. 10. 3 compares relationships between rotational speed and increases in bearing temperature of Types R and C and conventional high-precision bearings.

High Ability bearings exhibit smaller temperature increases and higher speed limits than conventional bearings whether grease lubrication or oil / air lubrication is applied.

As shown in **Fig. 10. 4**, this type has excellent anti-seizure characteristics with small quantity of lubricant oil in comparison with a conventional type. Thus, the quantity of the lubricant oil can be reduced.

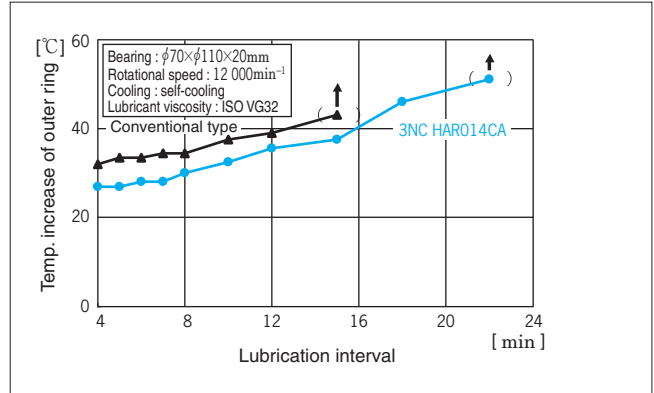

Fig. 10. 4 Comparison of seizure limit oil quantity of Type R and conventional type

High Ability bearings also allow the possible change in lubrication of the spindle from oil / air to grease.

Fig. 10. 5 shows an evaluation example.

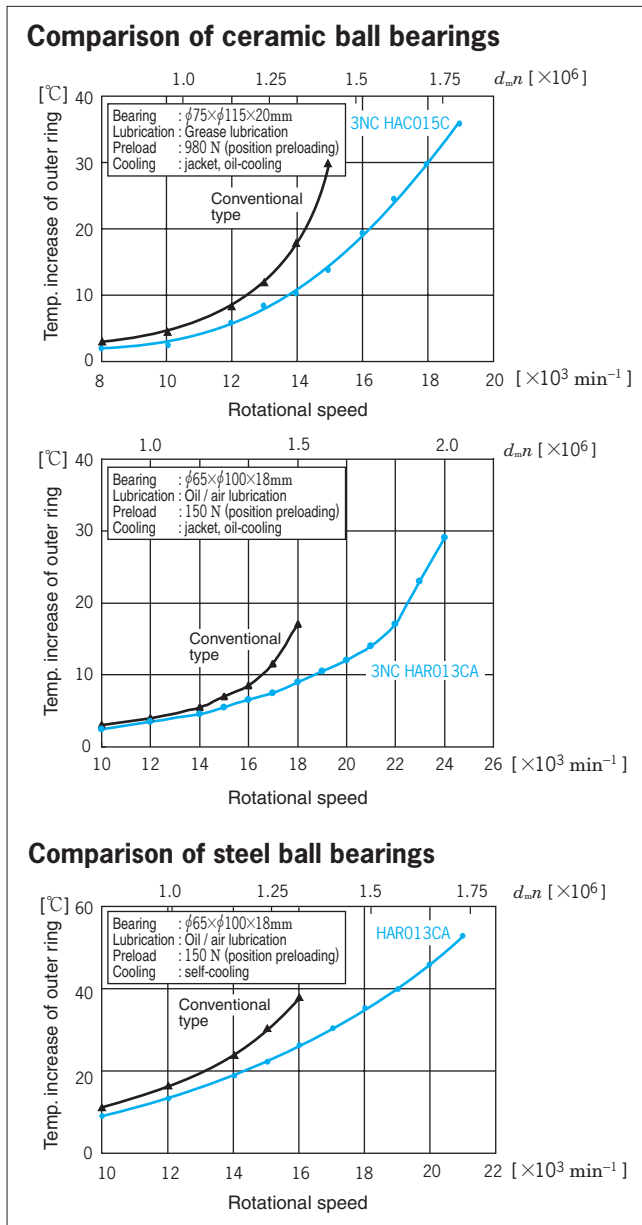

Fig. 10. 3 Comparison of increases in bearing temp.

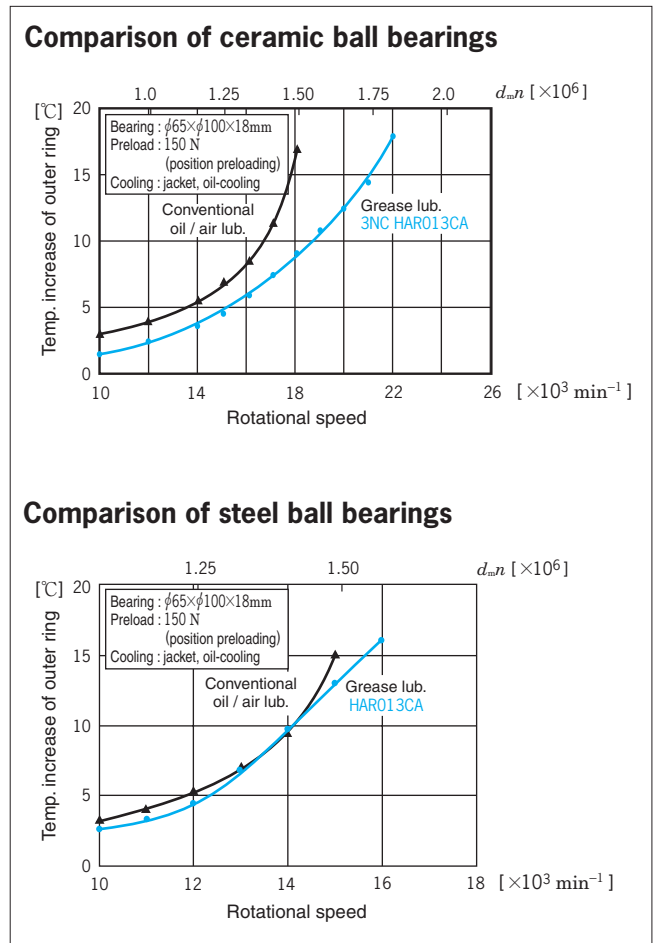

Fig. 10. 5 Comparison of high-speed performance achieved by grease lubrication

Type R high ability ceramic ball bearing and grease lubrication exhibits better high-speed performance than conventional bearings using oil / air lubrication.

If steel balls are used, Type R with grease lubrication exhibits high-speed performance equal to or better than conventional bearings with oil / air lubrication.

2) Performance of Type D

Fig. 10. 6 compares the high-speed performance of Types D and R.

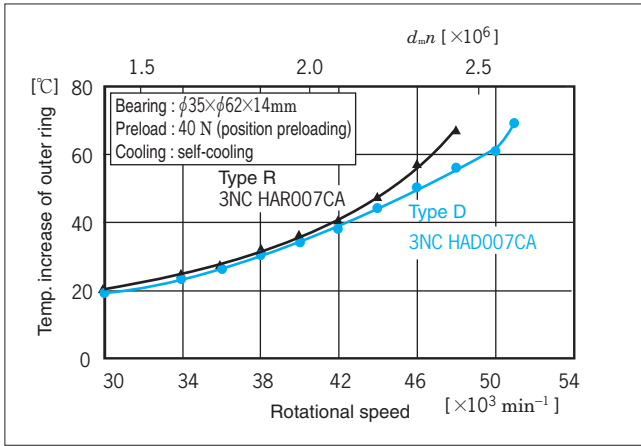

Fig. 10. 6 Comparison of increases in the bearing temp. of Types R and D

Also, Type D causes little wind roar when the bearing is rotating, and is effective in reducing the noise of the spindle device and the air consumption. (Figs. 10. 7 and 10. 8)

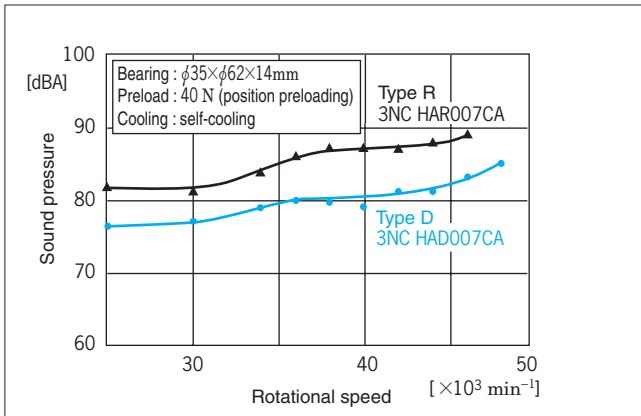

Fig. 10. 7 Comparison of noise by Types R and D

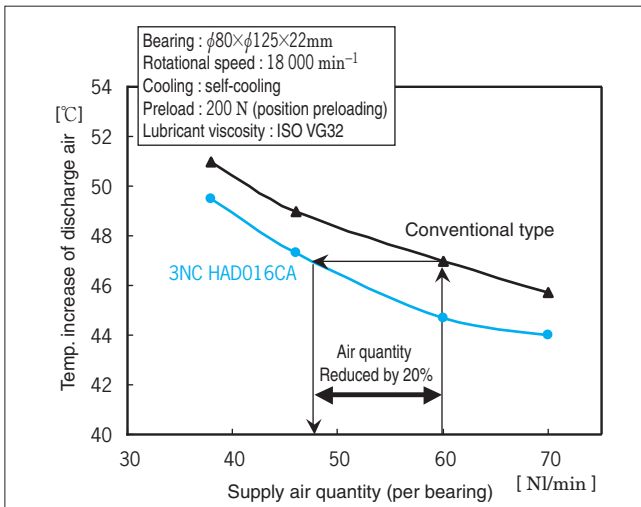

Fig. 10. 8 Comparison of air quantity of Type D and conventional type

3) Performance of Type F

Fig. 10. 9 shows an evaluation example of the Type F bearing operated with a preload given by constant pressure preloading. The maximum rotational speed achieved in this test, or 54 000 min^{-1} , equals 3.3×10^6 in $d_m n$ value.

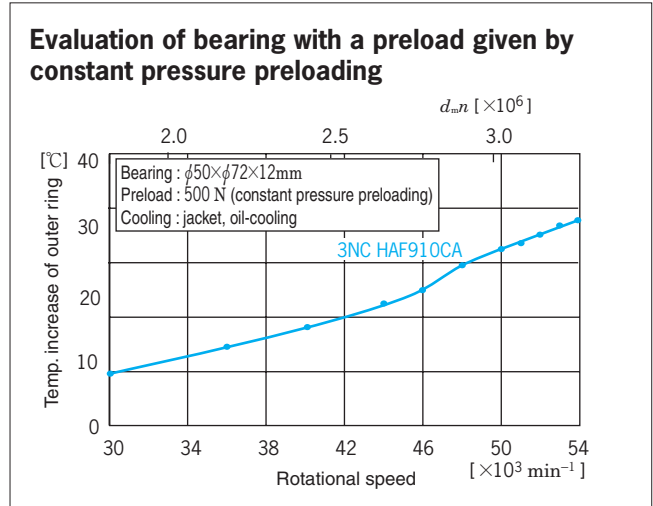

Fig. 10. 9 Temp. increases in Type F bearing

The oiling port in the outer ring provides sufficient lubrication to achieve a substantial reduction of friction on cage riding land. This lubrication method ensures excellent stability against rapid acceleration or deceleration during operation.

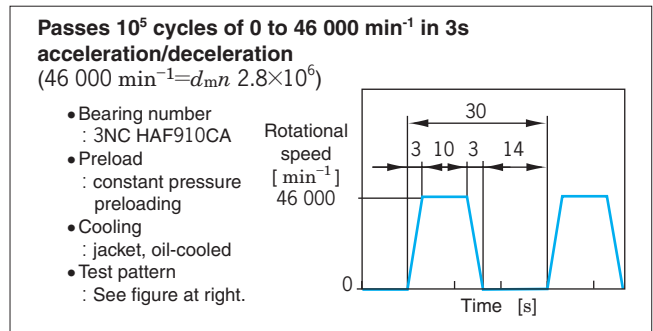

Fig. 10. 10 Operating pattern of type F involving rapid acceleration and deceleration

11. Ceramic bearings for machine tool spindles



Compared with bearing steel, ceramics [silicon nitride (Si_3N_4)] has superior properties such as light weight and high elasticity.

One of the advantages of ceramics when used as a material for bearings is a reduction in the slip of rolling elements caused by centrifugal force and gyroscopic moments under high-speed rotation. Ceramic material is highly effective for meeting the low temperature increase requirements of the bearing.

Other advantages include improved rigidity and improvements in seizure life and grease service life. Ceramic bearings, although varying depending on operating conditions, allow approximately 30% to 50% improvement in speed as compared with steel bearings.

11.1 Ceramic bearing structures and types

There are three types of ceramic bearings differing in their combinations of ceramic parts. Select the most suitable one from **Table 11.1** according to the machine tool specifications.

Table 11.1 Ceramic bearing structures and types

Codes, types, and structures of ceramic bearings			
Code ¹⁾	3NC	6NC	NC
Description	Rolling element : ceramics	Inner ring : ceramics Rolling element : ceramics	Inner and outer rings : ceramics Rolling element : ceramics (Full-ceramic)
Angular contact ball bearing			
Cylindrical roller bearing			

Note 1) A code is placed before a basic bearing number.

11.2 Properties of ceramics (Si_3N_4)

Sintered in a high temperature and high-pressure gas atmospheric condition (HIP), ceramics (silicon nitride) has many superior properties such as heat resistance, light weight, low coefficient of linear expansion, and a high elastic modulus.

Table 11.2 shows a comparison of properties with ceramics and bearing steel.

Table 11.2 Comparison of mechanical properties

Item	Unit	Ceramics (Si_3N_4)	Bearing steel (SUJ2)
Heat resistance (in the air)	°C	800	120
Density	g/cm^3	3.2	7.8
Coefficient of linear expansion	K^{-1}	3.2×10^{-6}	12.5×10^{-6}
Vickers' hardness	HV	1 300~2 000	700~800
Young's modulus	GPa	320	208
Poisson's ratio	—	0.29	0.3
Thermal conductivity	$\text{W}/(\text{m}\cdot\text{K})$	20	41.9~50.2
Corrosion resistance	—	Good	Not good
Magnetism	—	Non-magnetic material	Ferromagnetic material
Electrical conductivity	—	Not applicable (insulant)	Applicable (electric conductor)
Bonding form of material	—	Covalent bond	Metallic bond

11.3 Load ratings of ceramic bearings

JTEKT has adopted the following values as a standard for load ratings of ceramic bearings. These values are determined from a number of experiments and their results.

- (1) Dynamic load rating :
Dynamic load rating of steel bearings (C) $\times 1.0$ or greater
- (2) Static load rating :
Static load rating of steel bearings (C_0) $\times 1.0$

The load applied to a spindle bearing for a machine tool is generally very small as compared with bearing load ratings. Accordingly, it is rare that a bearing reaches its fatigue service life or brinelling occur in its raceway surfaces.

Sufficient care, however, should be taken to ensure that no impact load is applied to the bearing during handling and operation.

11. 4 Sample test data of ceramic bearings

1) High-speed performance of bearings

Ceramic is superior to bearing steel in high-speed rotation performance because it has lower density and linear expansion coefficient.

■ Comparison with steel bearing (1)

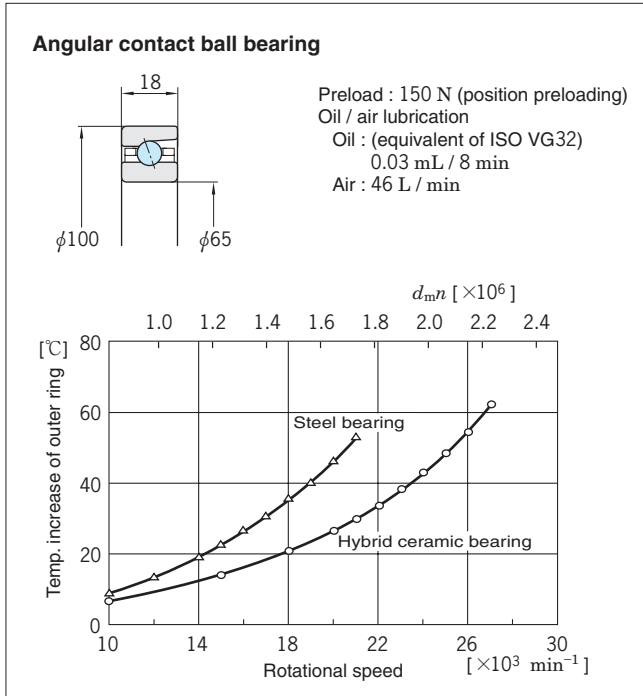

Fig. 11. 1 Comparison of Angular contact ball bearing

■ Comparison with steel bearing (2)

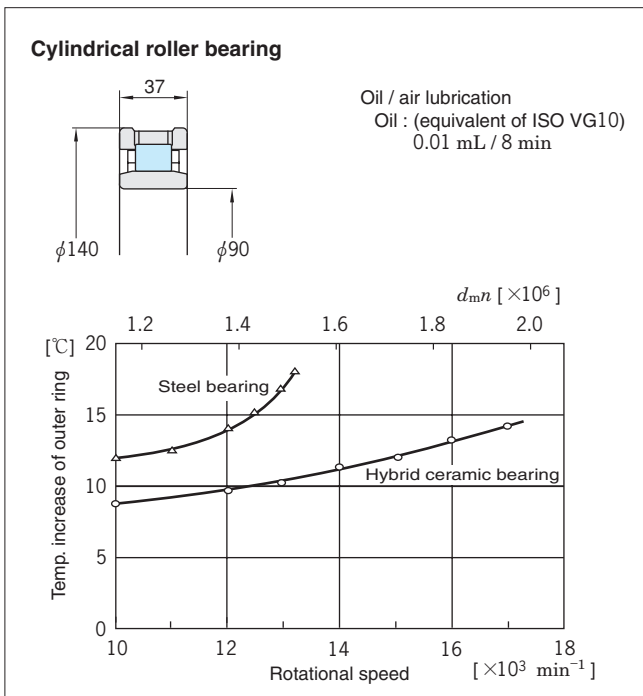

Fig. 11. 2 Comparison of cylindrical roller bearing

■ High-speed performance (1)

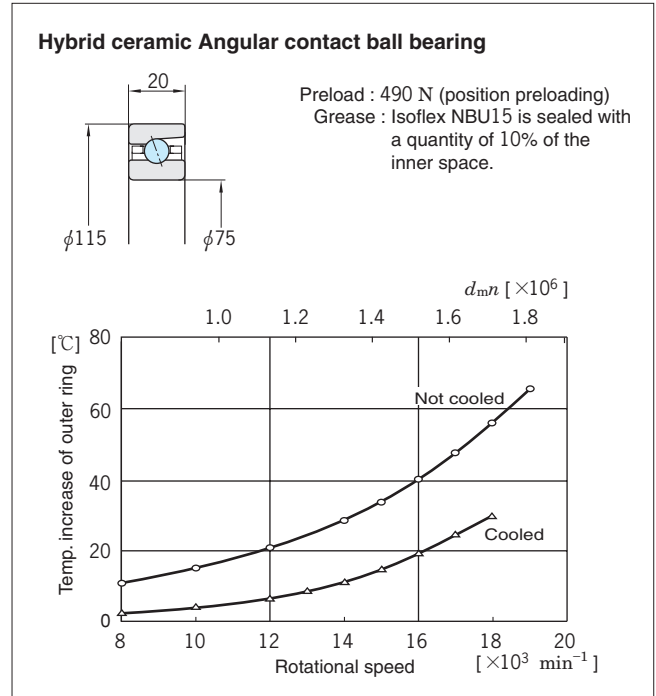

Fig. 11. 3 High speed performance with grease lub.

■ High-speed performance (2)

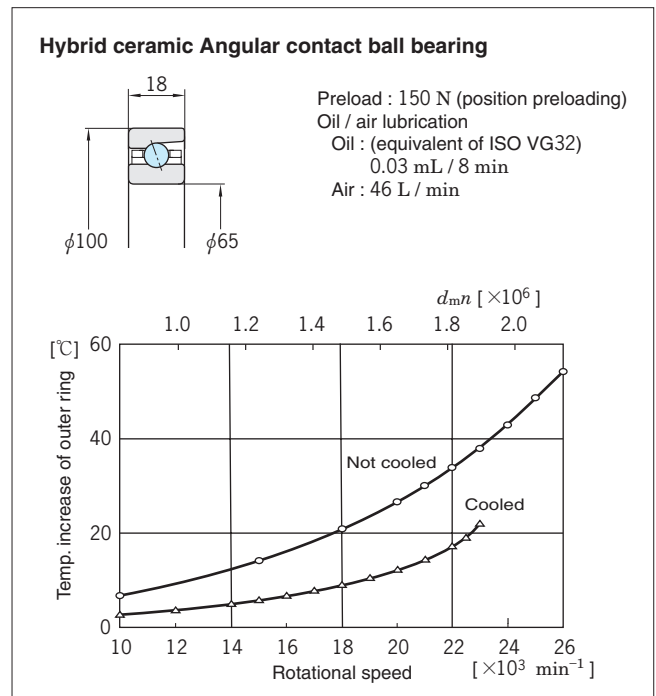

Fig. 11. 4 High speed performance with oil / air lub.

The 6NC type hybrid ceramic bearings, whose balls and inner ring are both made of ceramic, are superior in high-speed performance to the 3NC type.

In addition, the low-torque 6NC type bearings exhibit lower power losses at high rotational speeds.

■ High-speed performance (3)

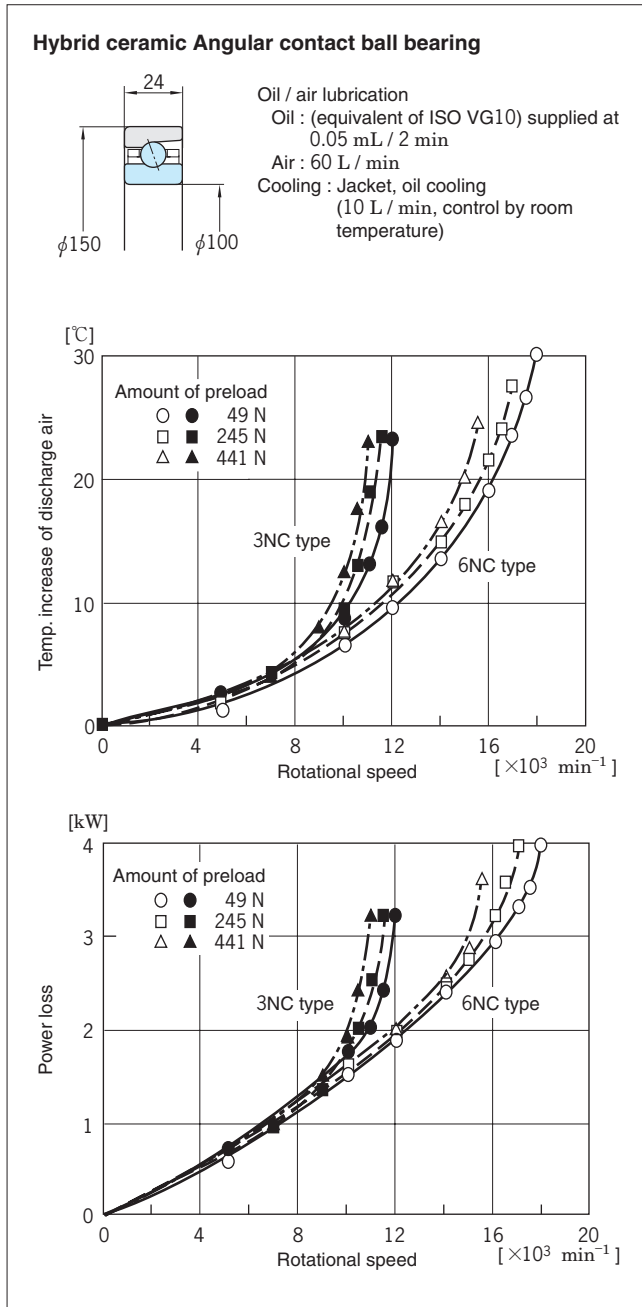

Fig. 11.5 Comparison of 3NC type and 6NC type hybrid ceramic bearings

Since ceramics and steel have different coefficients of linear expansion, Young's moduli, and Poisson's ratios, care should be taken when fitting for mounting a 6NC type hybrid ceramic bearing on a shaft is selected.

Consult JTEKT.

2) Rigidity of bearing

Since ceramics have a greater Young's modulus than bearing steel, the rigidity of a ceramic bearing is higher than that of a steel bearing.

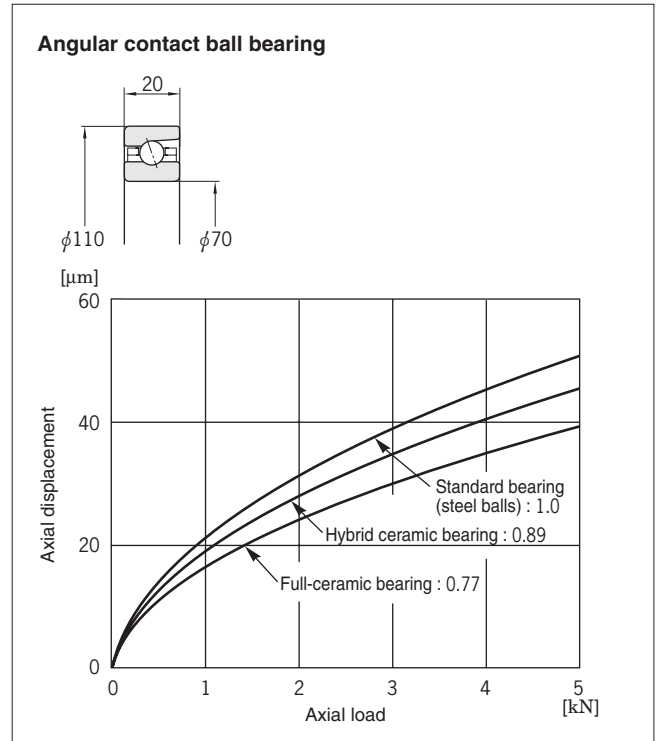

Fig. 11.6 Comparison of axial displacement

3) Changes in shaft dimensions

Compared with steel bearings, ceramic bearings have higher rigidity and lower temperature increase, thus reducing the risk of changes in shaft dimensions.

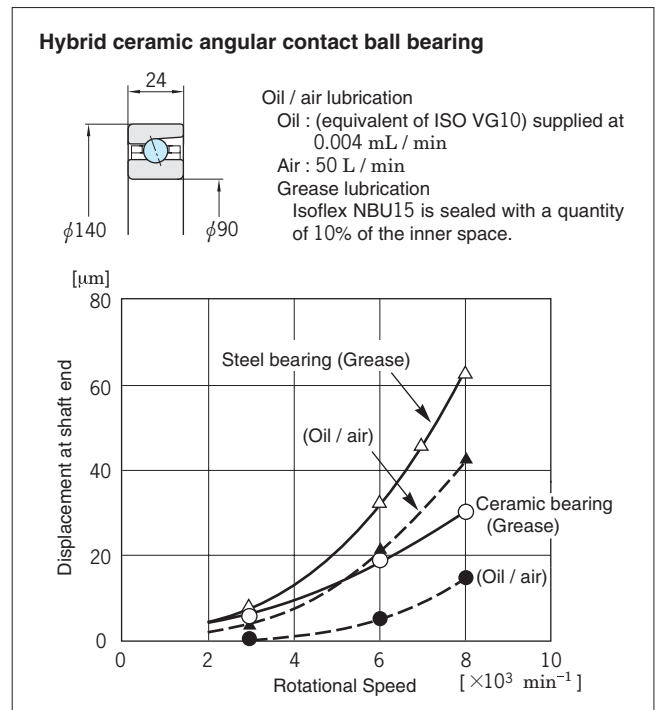

Fig. 11.7 Comparison of displacement at shaft end

4) Fatigue service life and seizure life of bearings

Ceramic bearings are superior to steel bearings in both seizure life and fatigue service life.

■ Seizure life test results (1)

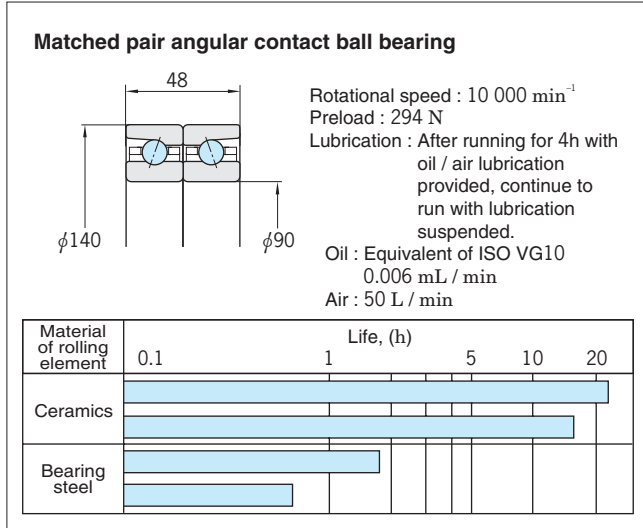

Fig. 11. 8 Seizure life test results of hybrid ceramic bearings and steel bearings

■ Seizure life test results (3)

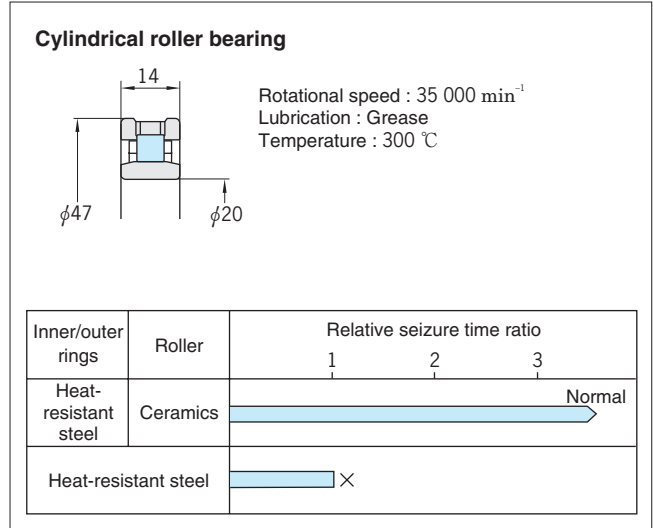

Fig. 11. 10 Seizure life test results of hybrid ceramic bearings and heat resisting steel bearings

■ Seizure life test results (2)

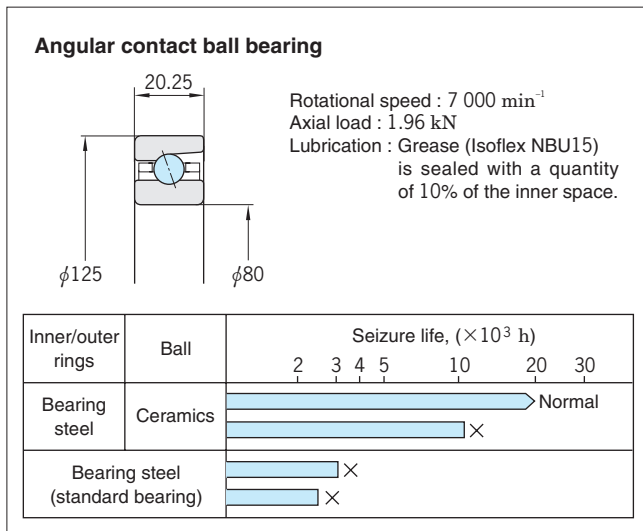

Fig. 11. 9 Seizure life test results of hybrid ceramic bearing and steel bearing

■ Fatigue service life test result

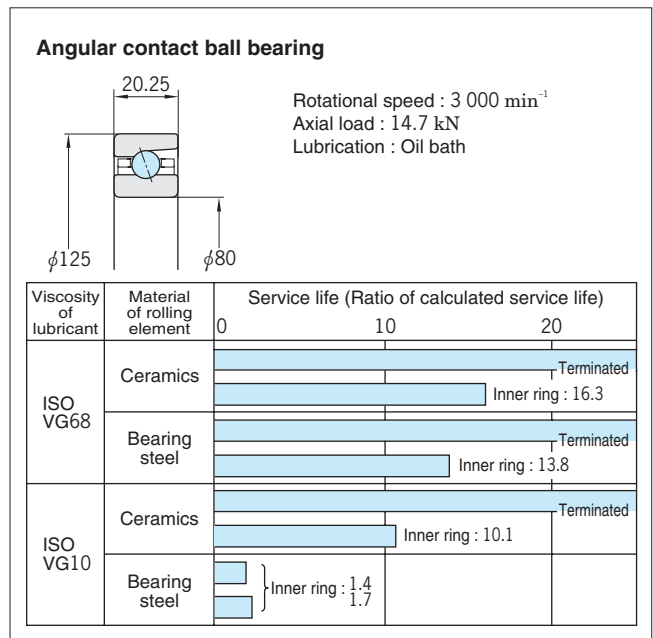

Fig. 11. 11 Life test results of a hybrid ceramic bearing



**Precision Ball & Roller
Bearings**

**Bearing Dimension
Tables**

1. Angular Contact Ball Bearings

Contents

	Page
1. 1 Types and features of angular contact ball bearings	53
1. 2 Matched pair angular contact ball bearings	54
1. 3 Composition of bearing numbers	55
1. 4 Tolerance of bearings	56
1. 5 Standard preloads for matched pair angular contact ball bearings	58
1. 6 Axial load and displacement	60
■ Bearing dimension tables	
· 7900C series	66
· 7000C, 7000 series	68
· 7200C, 7200 series	72
· 7900CPA, 7000CPA, 7200CPA series	76
· HAR900C, HAR900CA, HAR900 series	82
· HAR000C, HAR000CA, HAR000 series	88
· 3NCHAR900C, 3NCHAR900CA, 3NCHAR900 series	94
· 3NCHAR000C, 3NCHAR000CA, 3NCHAR000 series	100
· 3NCHAC900C, 3NCHAC900CA series	106
· 3NCHAC000C, 3NCHAC000CA series	110
· 3NCHAD000CA series	114
· 3NCHAF900CA, 3NCHAF000CA series	116



1. Angular contact ball bearings

The angular contact ball bearing can receive a radial load, unidirectional axial load, or a combination of the above loads.

There are four different contact angles to choose from when angular contact ball bearings are considered: 15° (contact angle symbol: C), 20° (CA), 30° (A: to be omitted), and 40° (B) (see Fig. 1. 1).

Of these types, the 15° (contact angle symbol: C), 20° (CA) and 30° (A) bearings are usually used for spindle of machine tools.

The greater the contact angle, the higher the axial rigidity, and the smaller the contact angle, the more advantageous for high-speed rotations.

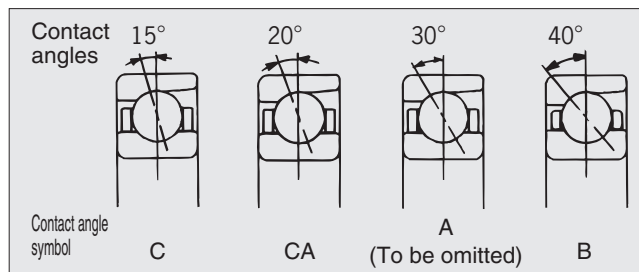

Fig. 1. 1 Contact angles of angular contact ball bearings

1. 1 Types and features of angular contact ball bearings

Standard angular contact ball bearings				High Ability angular contact ball bearings			
7900C	7000C 7000	7200C 7200	7900CPA 7000CPA 7200CPA	HAR900C HAR900CA HAR900 HAR000C HAR000CA HAR000	HAC900C HAC900CA HAC000C HAC000CA	HAD000CA	HAF900CA HAF000CA
				<p>*The bearing numbers of the HAC, HAD and HAF type products begin with the prefix "3NC," because they have ceramic balls as standard components.</p>			
				<p>*Consult JTEKT, as the HAR000 series can correspond to the non-contact seal.</p>			

Fig. 1. 2 Types and series of angular contact ball bearings

1) Standard angular contact ball bearings

7900C
7000C, 7000 series
7200C, 7200

The standard cage is of the ball-guided type and is made from polyamide resin.

7900CPA, 7000CPA, 7200CPA series

- The cages of these bearings are of the outer ring-guided type and are made from reinforced phenolic resin. This type of cage enables superior high-speed performance.
- Bearings that can be disassembled into an outer ring, cage and ball assembly and inner ring are also available.

2) High Ability angular contact ball bearings

HAR900C, HAR900CA, HAR900 HAR000C, HAR000CA, HAR000	High rigidity type
HAC000C, HAC000CA, HAC900C HAC900CA	High load-rating type
HAD000CA, HAF900CA, HAF000CA	Ultra-high speed type

- The High Ability angular contact ball bearings are optimized for use on high-speed machine tool spindles. They are available in three types: high rigidity type, high load-rating type, and ultrahigh-speed type. (The ultrahigh-speed type is used with oil / air lubrication.)
- The standard contact angle of these bearings is 20°. The high rigidity type products are also available with a contact angle of 15° and 30°. The high load-rating type products are also available with a contact angle of 15°.
- These bearings have ceramic balls and an outer ring-guided cage made from reinforced phenol resin as standard components.
Steel-ball products and ball-guided cage products are also available to suit your needs.

1.2 Matched pair angular contact ball bearings

Angular contact ball bearings are used in matched pair, or in combinations of more than two bearings. **Table 1. 1** shows combination types and symbols for angular contact ball bearings.

Table 1. 1 Combination types and symbols for angular contact ball bearings

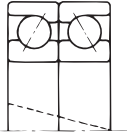
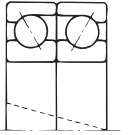
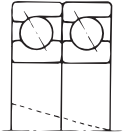
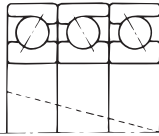
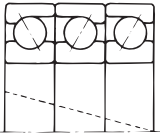
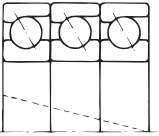
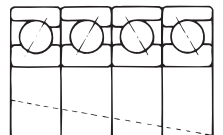
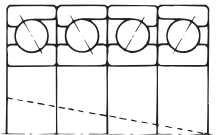
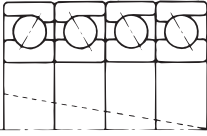
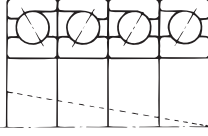
Combination types and symbols for angular contact ball bearings			
Matched pair	 Back-to-back Suffix : DB	 Face-to-face Suffix : DF	 Tandem Suffix : DT
	 Suffix : DBD	 Suffix : DFD	 Suffix : DTD
	 Suffix : DBB	 Suffix : DFF	
Matched stack	 Suffix : DBT	 Suffix : DFT	

[Remark] ----- indicates the direction of the "V" mark.

Matched pair angular contact ball bearings are adjusted to a preset amount of preload and axial clearance.

The standard preloads are divided into 4 classes : slight preload (symbol : S), light preload (L), medium preload (M), and heavy preload (H). **Table 1. 4** (page 58) shows amounts of standard preloads.

Cautions for assembly

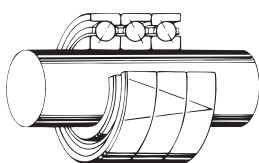

(Combination mark)

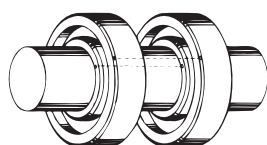

(Mark indicating position of maximum eccentricity)

Type G bearings

The type G bearing has both sides machined (flush-ground) to obtain the same stand-out between the inner and outer rings (see **Fig. 1. 3**).

This makes it possible to select any desired combination(s) from **Table 1. 1**.

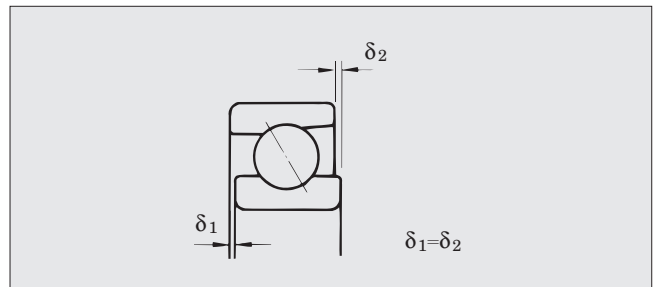

Fig. 1. 3 Flush-ground type G bearings

- Examples of identification numbers of type G bearings
 - 7010GL : Adjustment is made so that any combination of two or more bearings presents light preload (preload symbol : L).
 - 7010GL×2 : Adjustment is made so that any combination of this set of two bearings presents light preload (preload symbol : L).

- A "V" mark is put on the outside surfaces of the outer rings of matched pair or matched stack angular contact ball bearings, to indicate their combination mode. Combine them in such a way that the marks on the outer ring form a "V".
- Chamfered edges of the inner and outer rings are marked with a circle "○", which shows the position of maximum eccentricity.

Mount bearings so that the "○" marks on the inner and outer rings are opposite (180°) to the position of maximum eccentricity of the shaft or housing. By doing so, maximum running accuracy is obtained.

1. 3 Composition of bearing numbers (angular contact ball bearings)

7018CPAK5DBL /27AFTP5
3NCHAR018C-5K5DBCS5/27AFGP4

Ceramic bearing

Bearing type symbol

7 : angular contact ball bearing

HAR }
 HAC } High Ability angular
 HAD } contact ball bearings
 HAF }

Dimension series symbol

9 : dimension series 19

0 : dimension series 10

2 : dimension series 02

Bore diameter number

18 : nominal bore diameter : 90 mm
 (bore diameter number × 5 equals
 nominal bore diameter.)

Contact angle symbol

A : nominal contact angle : 30° (A is to be omitted.)

B : nominal contact angle : 40°

C : nominal contact angle : 15°

CA : nominal contact angle : 20°

Cage guiding system symbol

No specified : inner ring-guiding
 (outer ring-guiding for HAR, HAC, HAD, HAF)

PA : outer ring-guiding

-5 : ball-guiding

Special permissible dimensional deviation symbol

K5 : JTEKT's special permissible dimensional deviations are
 used for the bore diameter of the inner ring and the
 outside diameter of the outer ring.

No specified : If standard permissible dimensional deviations
 are used.

Tolerance class symbol

P5 : JIS class 5

P4 : JIS class 4

P2 : JIS class 2

Cage symbol

FG : molded cage made of
 polyamide resin

FT : machined cage made of
 reinforced phenolic

FY : machined cage made of
 copper alloy

Spacer number/symbol

No specified : If no spacer is provided.

/27 : spacer with lubrication hole, 27 mm in
 nominal width

A : spacer not provided with lubrication hole
 (symbol A is not used if the spacer has a
 lubrication hole.)

Preload symbol* or clearance symbols

(*In some cases, a symbol denoting the specific preload is used.)

S : slight preload CS : clearance

L : light preload CY : negative clearance (preload)

M : medium preload (CS5 : The mean value of the
 clearance is 5µm.)

H : heavy preload

(For amount of preload, see **Table 1. 4** (page 58).)

Matched pair or stack symbol

DB : back-to-back

DF : face-to-face

DT : tandem

For suffixes that denote bearings which consist
 of three or four bearings, see **Table 1. 1** (page 54).

G : Type G bearing (flush-ground bearing)

1. Angular contact ball bearings

1.4 Tolerance of bearings

The tolerance of the precision angular contact ball bearing is compliant with permissible dimensional deviations and limits of classes 5, 4, and 2 as specified in JIS B 1514 for radial bearings (tapered roller bearings not included).

Permissible dimensional deviations and limits of radial bearings are shown in **Table 1. 2**.

Table 1. 3 (page 57) shows **JTEKT's** special permissible dimensional deviations (K5) used to facilitate multi-row combinations (K5 is used for the bore diameter of the inner ring and the outside diameter of the outer ring).

Table 1. 2(1) Permissible dimensional deviations and limits of angular contact ball and cylindrical roller bearings

(1) Inner ring

Unit : μm

Nominal bore diameter d (mm)		Single plane mean bore diameter deviation Δd_{mp}						Single bore diameter deviation $\Delta d_s^{1)}$				Single plane bore diameter variation V_{dsp}			Mean bore diameter variation V_{dmp}					
		Class 5		Class 4		Class 2		Class 4		Class 2		Diameter series 7, 8, 9		Diameter series 0, 1, 2, 3, 4		-	Class 5		Class 4	Class 2
		upper	lower	upper	lower	upper	lower	upper	lower	upper	lower	max.	max.	max.	max.	max.	max.	max.	max.	
over	up to																			
10	18	0	-5	0	-4	0	-2.5	0	-4	0	-2.5	5	4	4	3	2.5	3	2	1.5	
18	30	0	-6	0	-5	0	-2.5	0	-5	0	-2.5	6	5	5	4	2.5	3	2.5	1.5	
30	50	0	-8	0	-6	0	-2.5	0	-6	0	-2.5	8	6	6	5	2.5	4	3	1.5	
50	80	0	-9	0	-7	0	-4	0	-7	0	-4	9	7	7	5	4	5	3.5	2	
80	120	0	-10	0	-8	0	-5	0	-8	0	-5	10	8	8	6	5	5	4	2.5	
120	150	0	-13	0	-10	0	-7	0	-10	0	-7	13	10	10	8	7	7	5	3.5	
150	180	0	-13	0	-10	0	-7	0	-10	0	-7	13	10	10	8	7	7	5	3.5	
180	250	0	-15	0	-12	0	-8	0	-12	0	-8	15	12	12	9	8	8	6	4	
250	315	0	-18	0	-15	-	-	0	-15	-	-	18	15	14	11	-	9	8	-	
315	400	0	-23	0	-18	-	-	0	-18	-	-	23	18	18	14	-	12	9	-	

Nominal bore diameter d (mm)		Radial runout of assembled bearing inner ring K_{ia}			S_d			$S_{ia}^{2)}$			Single inner ring width deviation ΔB_s				Single inner ring width deviation $\Delta B_s^{3)}$		Inner ring width variation V_{Bs}		
		Class 5	Class 4	Class 2	Class 5	Class 4	Class 2	Class 5	Class 4	Class 2	Classes 5, 4		Class 2		Classes 5, 4		Class 5	Class 4	Class 2
over	up to	max.			max.			max.			upper	lower	upper	lower	upper	lower	max.		
10	18	4	2.5	1.5	7	3	1.5	7	3	1.5	0	-80	0	-80	0	-250	5	2.5	1.5
18	30	4	3	2.5	8	4	1.5	8	4	2.5	0	-120	0	-120	0	-250	5	2.5	1.5
30	50	5	4	2.5	8	4	1.5	8	4	2.5	0	-120	0	-120	0	-250	5	3	1.5
50	80	5	4	2.5	8	5	1.5	8	5	2.5	0	-150	0	-150	0	-250	6	4	1.5
80	120	6	5	2.5	9	5	2.5	9	5	2.5	0	-200	0	-200	0	-380	7	4	2.5
120	150	8	6	2.5	10	6	2.5	10	7	2.5	0	-250	0	-250	0	-380	8	5	2.5
150	180	8	6	5	10	6	4	10	7	5	0	-250	0	-250	0	-380	8	5	4
180	250	10	8	5	11	7	5	13	8	5	0	-300	0	-300	0	-500	10	6	5
250	315	13	10	-	13	8	-	15	9	-	0	-350 ⁴⁾	-	-	0	-500 ⁴⁾	13	8	-
315	400	15	13	-	15	9	-	20	12	-	0	-400 ⁴⁾	-	-	0	-630 ⁴⁾	15	9	-

S_d : Perpendicularity of inner ring face with respect to the bore

S_{ia} : Axial runout of assembled bearing inner ring

- [Notes] 1) Tolerance class 4 is applied to bearings of diameter series 0, 1, 2, 3, and 4.
 2) Applied to angular contact ball bearings.
 3) Applied to individual bearing rings manufactured for matched pair or stack bearings.
 4) Class 5 tolerance complies with JIS; class 4 tolerance is **JTEKT** standard.

[Remark] Values in italics comply with **JTEKT** standards.

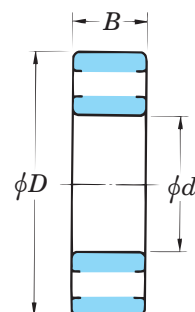

d : nominal bore diameter
 D : nominal outside diameter
 B : nominal bearing width

Table 1. 2(2) Permissible dimensional deviations and limits of angular contact ball and cylindrical roller bearings

(2) Outer ring

Unit : μm

Nominal outside diameter D (mm)		Single plane mean outside diameter deviation Δ_{Dmp}						Single outside diameter deviation $\Delta_{Ds}^{1)}$				Single plane outside diameter variation V_{Dsp}				Mean outside diameter variation V_{Dmp}			
		Class 5		Class 4		Class 2		Class 4		Class 2		Diameter series 7, 8, 9		Diameter series 0, 1, 2, 3, 4		Class 2	Class 5, Class 4, Class 2		
		upper	lower	upper	lower	upper	lower	upper	lower	upper	lower	max.	max.	max.	max.	max.	max.	max.	max.
18	30	0	-6	0	-5	0	-4	0	-5	0	-4	6	5	5	4	4	3	2.5	2
30	50	0	-7	0	-6	0	-4	0	-6	0	-4	7	6	5	5	4	4	3	2
50	80	0	-9	0	-7	0	-4	0	-7	0	-4	9	7	7	5	4	5	3.5	2
80	120	0	-10	0	-8	0	-5	0	-8	0	-5	10	8	8	6	5	5	4	2.5
120	150	0	-11	0	-9	0	-5	0	-9	0	-5	11	9	8	7	5	6	5	2.5
150	180	0	-13	0	-10	0	-7	0	-10	0	-7	13	10	10	8	7	7	5	3.5
180	250	0	-15	0	-11	0	-8	0	-11	0	-8	15	11	11	8	8	8	6	4
250	315	0	-18	0	-13	0	-8	0	-13	0	-8	18	13	14	10	8	9	7	4
315	400	0	-20	0	-15	0	-10	0	-15	0	-10	20	15	15	11	10	10	8	5
400	500	0	-23	0	-17	-	-	0	-17	-	-	23	17	17	13	-	12	9	-
500	630	0	-28	0	-20	-	-	0	-20	-	-	28	20	21	15	-	14	10	-

Nominal outside diameter D (mm)		Radial runout of assembled bearing outer ring K_{ea}			Perpendicularity of outer ring outside surface with respect to the face S_D			Axial runout of assembled bearing outer ring $S_{ea}^{2)}$			Deviation of a single outer ring width Δ_{Cs}		Ring width variation V_{Cs}		
		Class 5	Class 4	Class 2	Class 5	Class 4	Class 2	Class 5	Class 4	Class 2	Class 5, 4, 2	Class 5	Class 4	Class 2	
over	up to	max.			max.			max.			upper	lower	max.		
18	30	6	4	2.5	8	4	1.5	8	5	2.5	Same as tolerance Δ_{Bs}, d being that of the same bearing.	5	2.5	1.5	
30	50	7	5	2.5	8	4	1.5	8	5	2.5		5	2.5	1.5	
50	80	8	5	4	8	4	1.5	10	5	4		6	3	1.5	
80	120	10	6	5	9	5	2.5	11	6	5		8	4	2.5	
120	150	11	7	5	10	5	2.5	13	7	5		8	5	2.5	
150	180	13	8	5	10	5	2.5	14	8	5		8	5	2.5	
180	250	15	10	7	11	7	4	15	10	7		10	7	4	
250	315	18	11	7	13	8	5	18	10	7		11	7	5	
315	400	20	13	8	13	10	7	20	13	8		13	8	7	
400	500	23	15	-	15	12	-	23	15	-		15	9	-	
500	630	25	18	-	18	13	-	25	18	-	18	11	-		

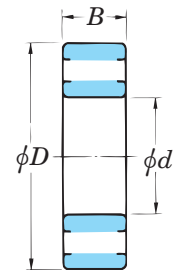

d : nominal bore diameter
 D : nominal outside diameter
 B : nominal bearing width

[Notes] 1) Tolerance class 4 is applied to bearings of diameter series 0, 1, 2, 3, and 4.

2) Applied to angular contact ball bearings.

[Remark] Values in italics comply with JTEKT standards.

Table 1. 3 JTEKT's specific tolerances of angular contact ball bearings (K5)¹⁾

Unit : μm

Nominal bore diameter d (mm)		Single plane mean bore or outside diameter deviation $\Delta_{dmp}, \Delta_{Dmp}$			
		Class 5		Class 4	
over	up to	upper	lower	upper	lower
-	50	-1	-4	-1	-3
50	80	-1	-5	-1	-4
80	120	-1	-5	-1	-4
120	150	-1	-5	-1	-4
150	180	-1	-5	-1	-4
180	250	-1	-5	-1	-4

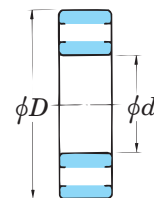

d : nominal bore diameter
 D : nominal outside diameter

[Note] 1) K5 denotes specially formulated JTEKT standards for the purpose of minimizing individual differences in performance, which may occur as a result of fitting stack-mounted to bearings.

1. 5 Standard preloads for matched pair angular contact ball bearings

Back-to-back and face-to-face matched pair bearings are often used under a preload. By applying a preload to a bearing, the following effects are realized.

- 1) The rigidity of a bearing can be improved.
- 2) Running accuracy is improved.
- 3) Abnormal noise caused by vibration and resonance is prevented.

A greater preload results in higher bearing rigidity. However, such preload also influences other parameters of the bearing : service life, temperature, frictional torque, etc. Therefore, it is important to select an adequate preload, taking into consideration the rotational speed and lubrication conditions.

JTEKT offers 4 types of preset preloads, slight preload (S), light preload (L), medium preload (M), and heavy preload (H). This will enable the user to select any desired preload suitable for individual applications (see **Table 1. 4**).

As a guide for selecting the preload, light or medium preload is used for spindles of grinding machines, while medium or heavy preloads are used for spindle of lathes and milling machines.

Table 1. 4(1) Standard preloads for matched pair angular contact ball bearings

(S : slight preload; L : light preload; M : medium preload; H : heavy preload) Unit : N

Bore dia. No.	Bore dia. (mm)	7900C , 7900CPA			7000C , 7000CPA				7000		
		S	L	M	S	L	M	H	L	M	H
00	10	5	15	30	6	20	50	100	30	80	145
01	12	7	20	40	6	20	50	100	30	80	145
02	15	8	25	50	10	30	80	145	50	145	245
03	17	8	25	50	15	40	100	195	60	145	295
04	20	15	40	80	15	40	100	245	60	145	295
05	25	15	50	100	20	60	145	295	100	245	490
06	30	15	50	100	25	80	195	390	145	295	635
07	35	25	70	140	35	100	245	490	145	390	785
08	40	25	80	155	35	100	295	590	145	390	785
09	45	35	100	195	50	145	345	635	245	540	980
10	50	35	100	195	50	145	390	735	245	635	1 180
11	55	40	120	235	65	195	440	880	295	785	1 370
12	60	40	120	235	65	195	490	980	390	880	1 570
13	65	50	145	295	85	245	540	1 090	440	980	1 770
14	70	65	195	390	85	245	635	1 270	490	1 080	2 060
15	75	65	195	390	100	295	685	1 370	590	1 180	2 150
16	80	65	195	390	100	295	735	1 470	635	1 370	2 350
17	85	85	245	490	130	390	880	1 770	735	1 570	2 550
18	90	100	295	590	145	440	980	1 960	785	1 670	2 840
19	95	100	295	590	160	490	1 080	2 060	880	1 770	3 140
20	100	100	345	685	175	540	1 180	2 150	880	1 960	3 530
21	105	100	345	685	195	590	1 270	2 350	980	2 150	3 920
22	110	145	390	785	210	635	1 470	2 550	1 080	2 350	4 410
24	120	145	490	980	225	685	1 670	2 840	1 180	2 650	4 900
26	130	195	590	1 180	245	735	1 770	3 140	1 370	3 140	5 390
28	140	195	635	1 270	260	785	1 960	3 920	1 470	3 430	5 880
30	150	245	735	1 470	275	835	2 150	4 410	1 770	3 920	6 860
32	160	245	785	1 570	290	880	2 350	4 900	2 150	4 410	7 840
34	170	345	880	1 810	325	980	2 450	5 390	2 450	4 900	8 820
36	180	345	1 130	2 250	440	1 180	2 600	5 880	2 790	5 590	9 120
38	190	345	1 170	2 400	490	1 320	2 790	6 370	3 140	6 180	9 410
40	200	440	1 620	3 090	590	1 470	2 940	6 860	3 430	6 860	9 800

Table 1. 4(2) Standard preloads for matched pair angular contact ball bearings

(S : slight preload; L : light preload; M : medium preload; H : heavy preload) Unit : N

Bore dia. No.	Bore dia. (mm)	7200C, 7200CPA				7200		
		S	L	M	H	L	M	H
00	10	10	30	80	145	50	145	245
01	12	15	40	100	195	60	145	295
02	15	15	50	145	245	80	245	390
03	17	25	70	145	345	100	245	540
04	20	25	80	195	390	145	295	635
05	25	35	100	245	490	145	390	785
06	30	35	100	295	590	145	590	930
07	35	50	145	390	785	245	785	1 270
08	40	65	195	440	880	390	880	1 570
09	45	85	245	540	1 080	490	1 080	1 770
10	50	85	245	590	1 180	540	1 180	2 060
11	55	100	295	735	1 470	635	1 370	2 450
12	60	115	345	785	1 670	785	1 470	2 940
13	65	130	390	930	1 860	835	1 670	3 330
14	70	160	490	980	2 060	930	1 860	3 720
15	75	195	590	1 180	2 350	980	2 150	3 920
16	80	225	685	1 370	2 750	1 080	2 450	4 310
17	85	260	785	1 570	2 940	1 270	2 940	4 900
18	90	260	785	1 770	3 430	1 470	3 230	5 390
19	95	290	880	1 960	3 920	1 670	3 430	5 880
20	100	325	980	2 150	4 410	1 860	3 920	6 370
21	105	360	1 080	2 350	4 900	2 060	4 310	7 060
22	110	385	1 180	2 450	5 290	2 250	4 900	7 840
24	120	420	1 270	2 840	5 490	2 450	5 390	8 820
26	130	485	1 470	3 140	5 880	2 750	5 880	9 310
28	140	520	1 570	3 430	6 370	2 940	6 370	9 800
30	150	585	1 770	3 720	6 860	3 330	6 860	10 300
32	160	645	1 960	4 120	7 840	3 630	7 350	10 800
34	170	645	2 150	4 410	8 330	3 920	7 840	11 800
36	180	685	2 300	4 710	8 830	4 220	8 340	12 500
38	190	735	2 450	5 000	9 320	4 510	8 830	13 100
40	200	785	2 650	5 300	9 810	4 810	9 320	13 400

1. 6 Axial load and displacement (angular contact ball bearings)

Fig. 1. 4 shows relationships between axial load and displacement of KOYO angular contact ball bearings.

The graphs indicate that the greater the contact angle of a bearing, the smaller the axial displacement

(high rigidity).

The displacement curve of duplex bearings under a given preload is determined by the method shown in Fig. 6. 1 on page 26.

(1) 7900C, 7900CPA series (contact angle : 15°)

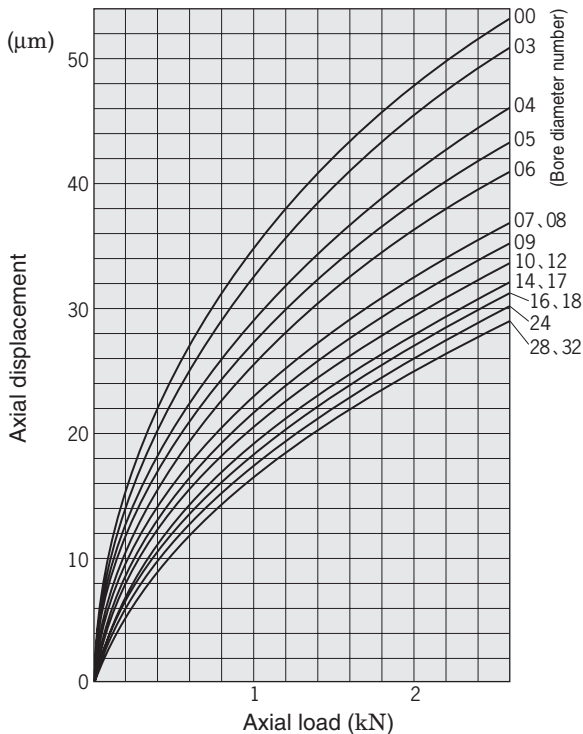

(2) 7000C, 7000CPA series (contact angle : 15°)

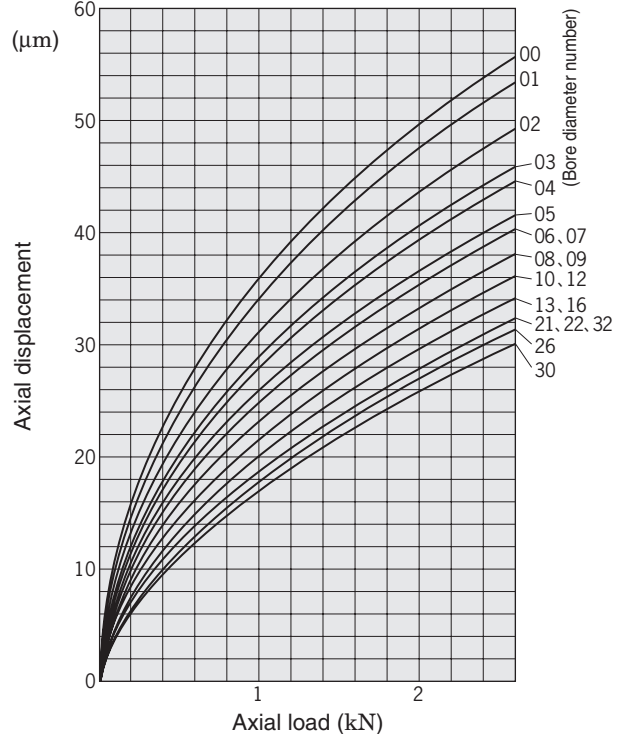

(3) 7000 series (contact angle : 30°)

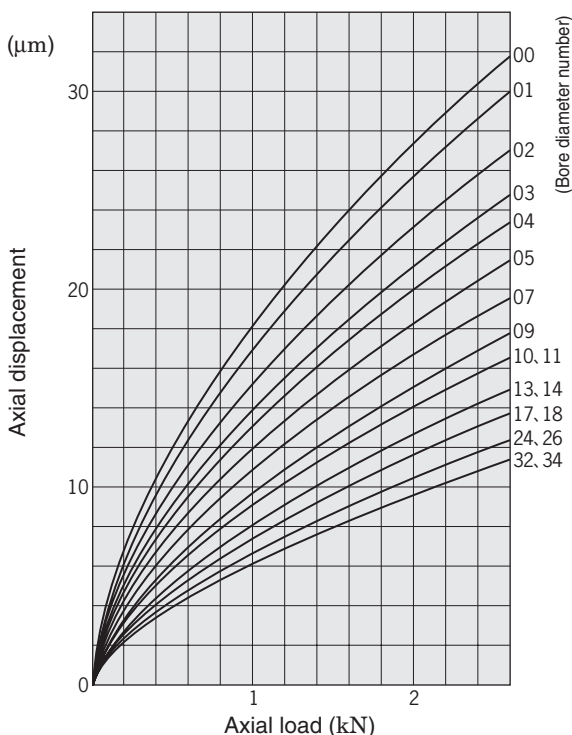

(4) 7200C, 7200CPA series (contact angle : 15°)

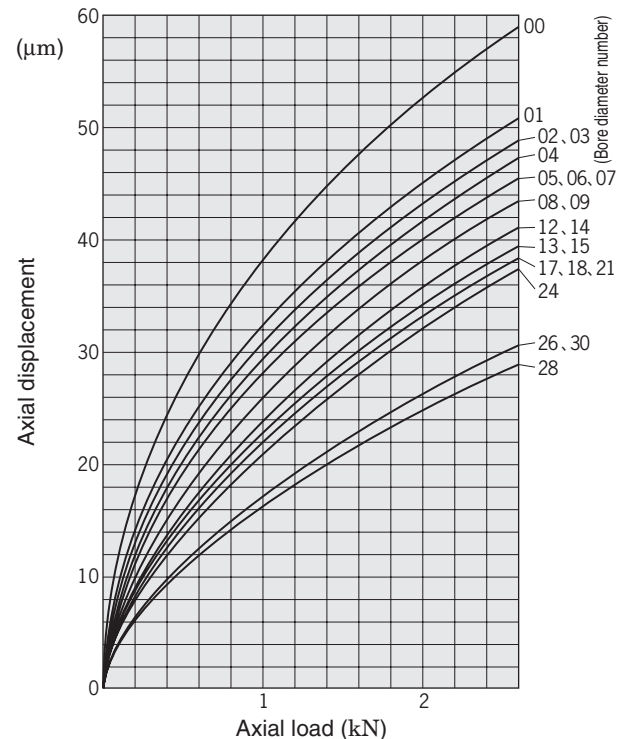
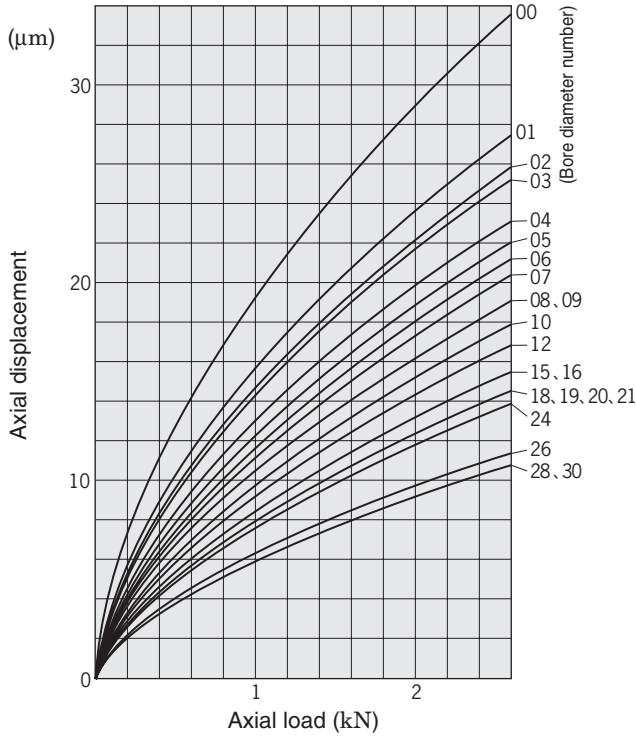

Fig. 1. 4 (1) Relationships between axial load and displacement (angular contact ball bearings)

*The axial displacements shown above are values of the single-row bearings not preloaded.

(5) 7200 series (contact angle : 30°)



(6) HAR900C series (contact angle : 15°)

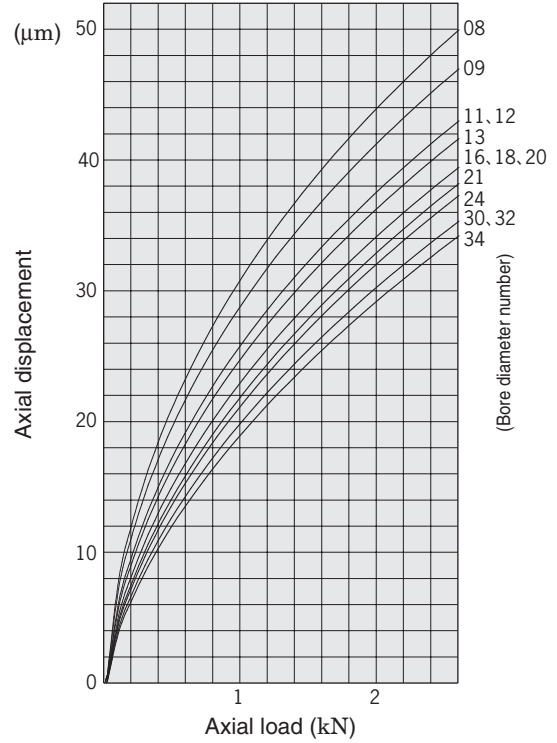

(7) HAR900CA series (contact angle : 20°)

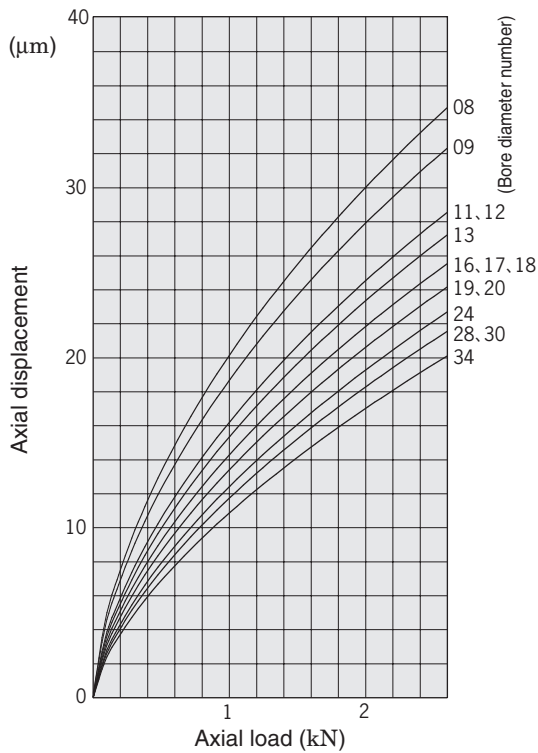

(8) HAR900 series (contact angle : 30°)

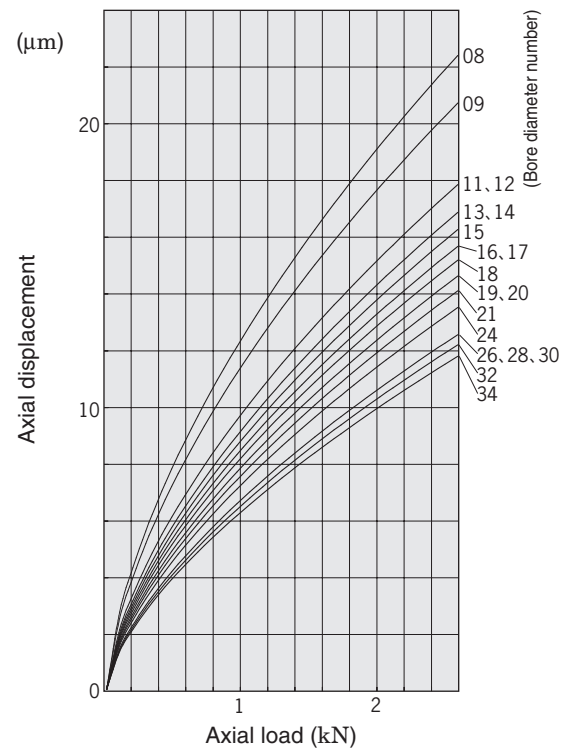
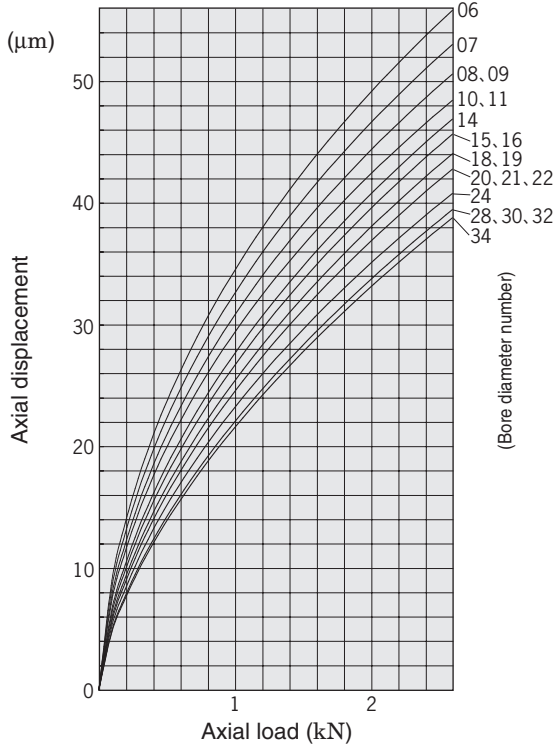

Fig. 1. 4 (2) Relationships between axial load and displacement (angular contact ball bearings)

*The axial displacements shown above are values of the single-row bearings not preloaded.

(9) HAR000C series (contact angle : 15°)



(10) HAR000CA series (contact angle : 20°)

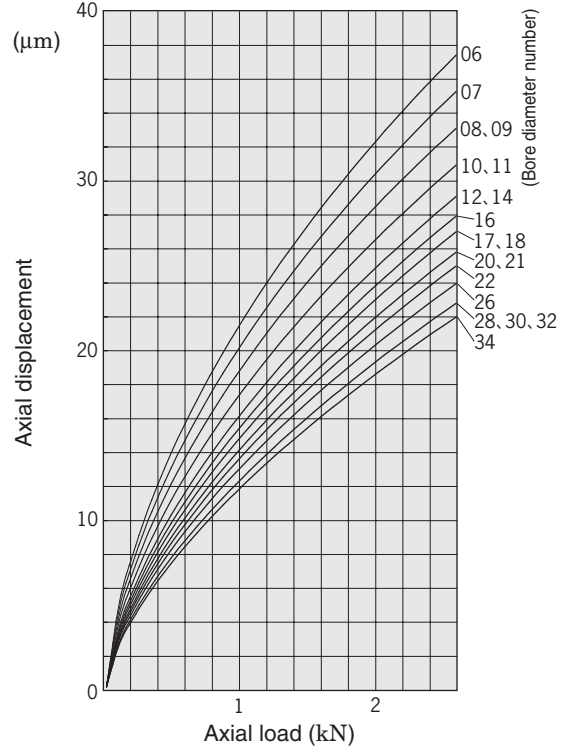

(11) HAR900 series (contact angle : 30°)

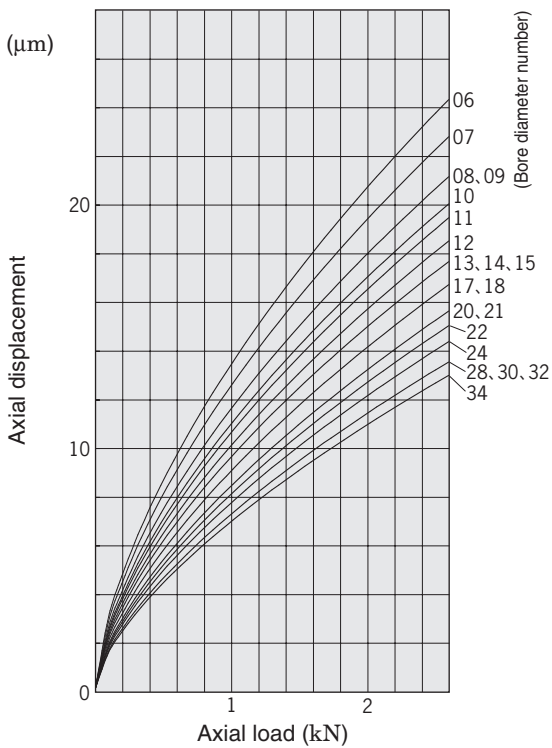

(12) 3NCHAR900C series (contact angle : 15°)

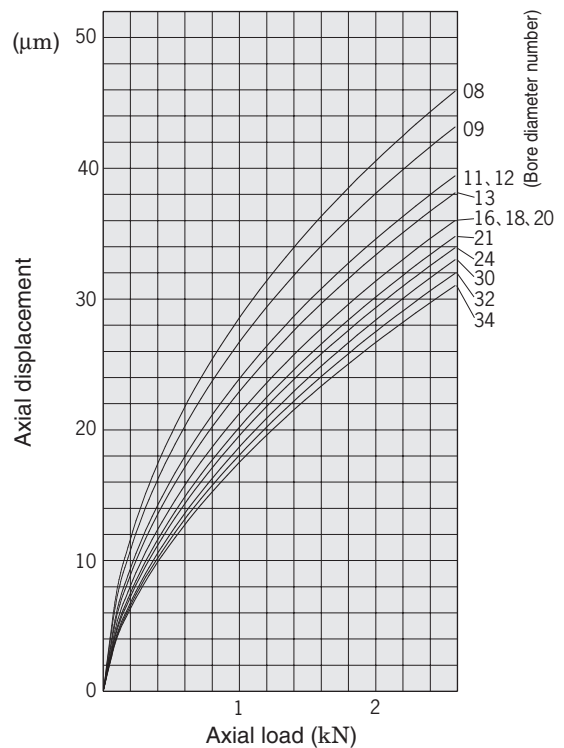
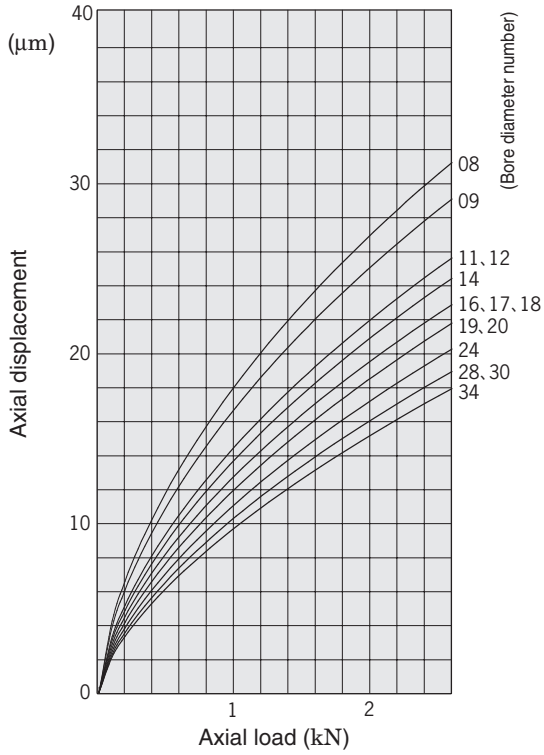

Fig. 1. 4 (3) Relationships between axial load and displacement (angular contact ball bearings)

*The axial displacements shown above are values of the single-row bearings not preloaded.

(13) 3NCHAR900CA series (contact angle : 20°)



(14) 3NCHAR900 series (contact angle : 30°)

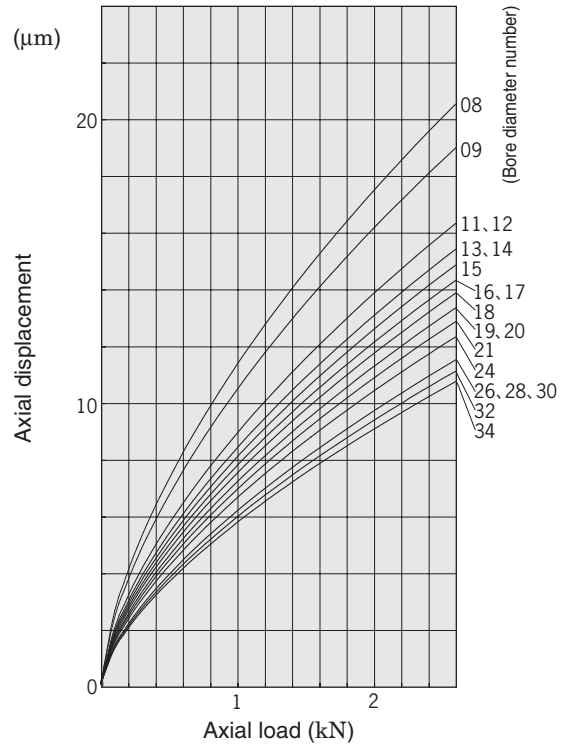

(15) 3NCHAR000C series (contact angle : 15°)

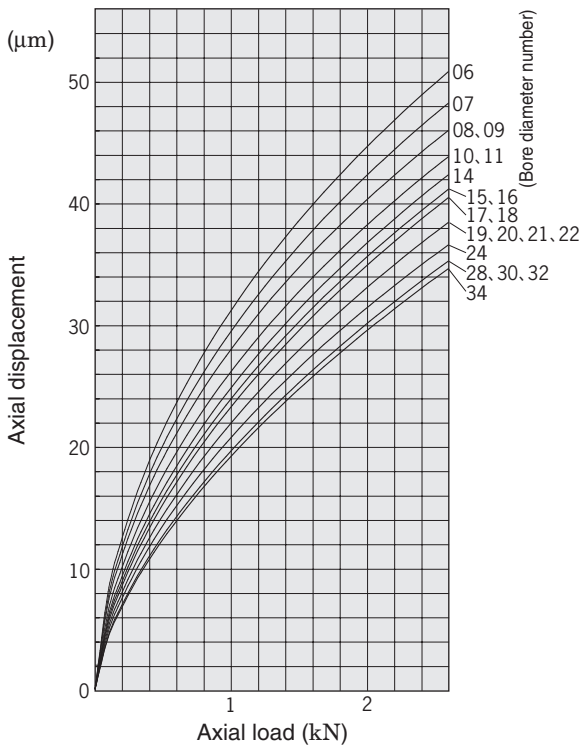

(16) 3NCHAR000CA series (contact angle : 20°)

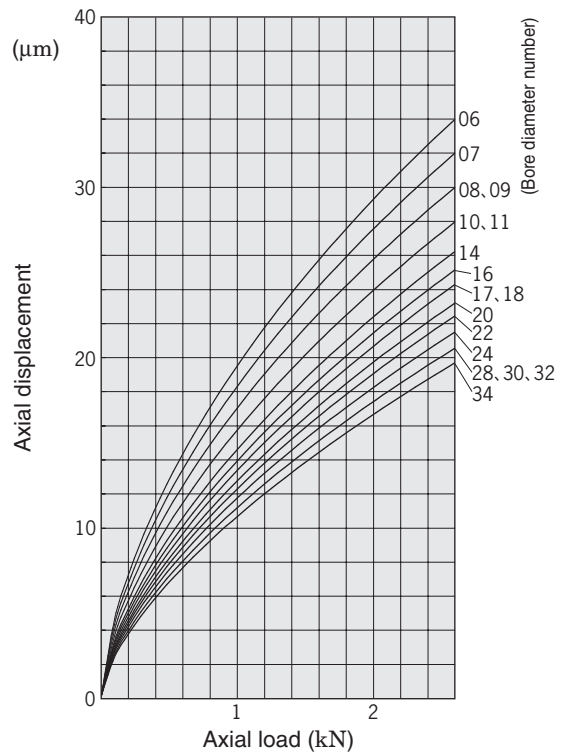
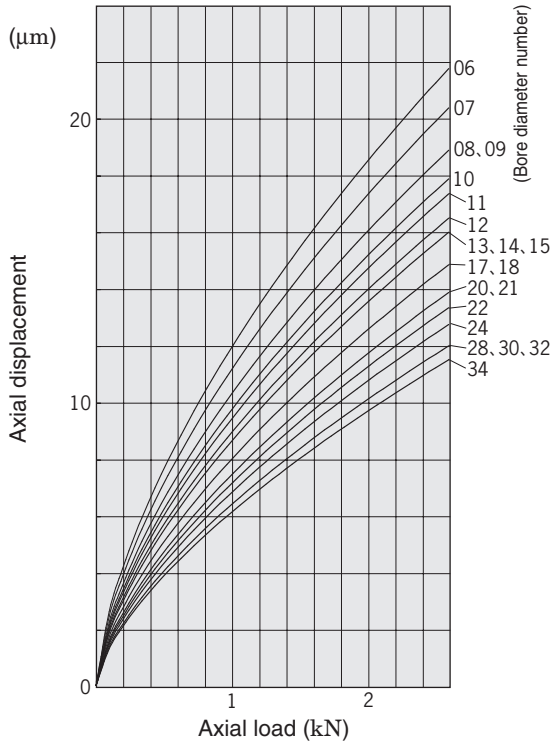

Fig. 1. 4 (4) Relationships between axial load and displacement (angular contact ball bearings)

*The axial displacements shown above are values of the single-row bearings not preloaded.

(17) 3NCHAR000 series (contact angle : 30°)



(18) 3NCHAC900C series (contact angle : 15°)

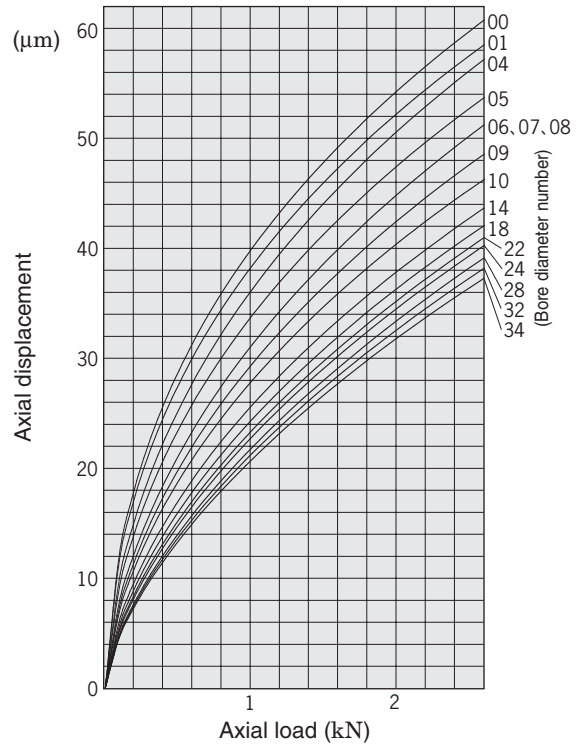

(19) 3NCHAC900CA series (contact angle : 20°)

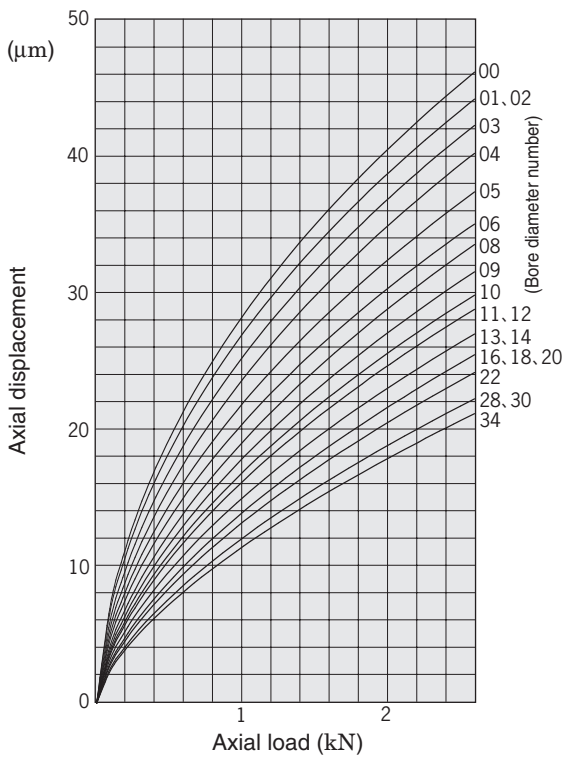

(20) 3NCHAC000C series (contact angle : 15°)

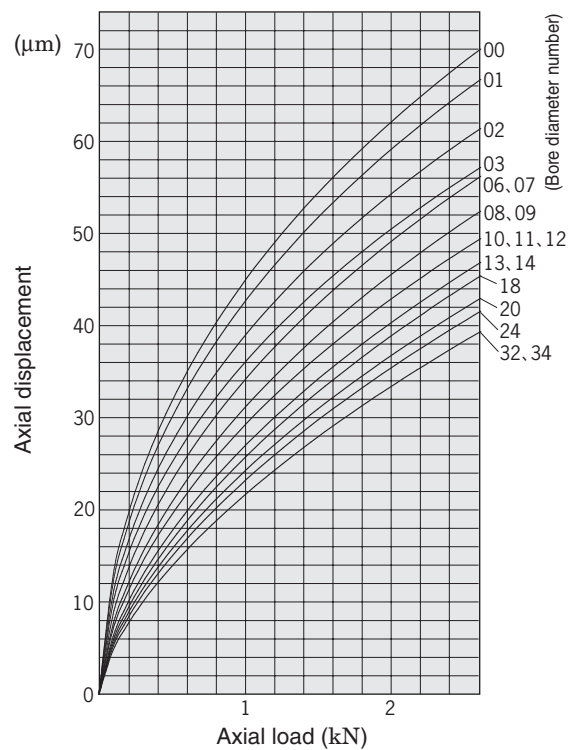
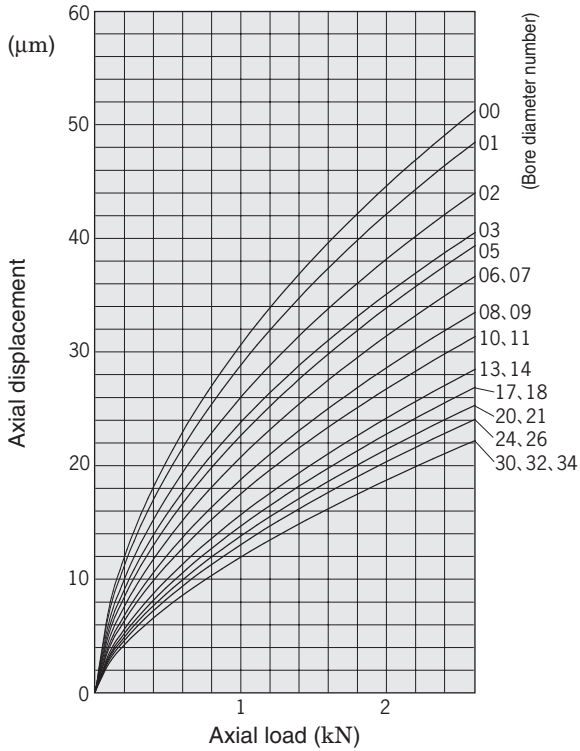

Fig. 1. 4 (5) Relationships between axial load and displacement (angular contact ball bearings)

*The axial displacements shown above are values of the single-row bearings not preloaded.

(21) 3NCHAC000CA series (contact angle : 20°)



(22) 3NCHAD000CA series (contact angle : 20°)

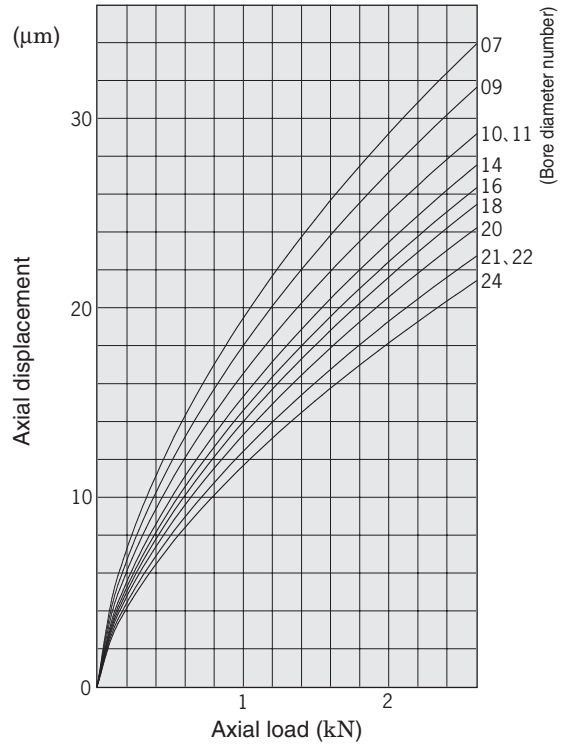

(23) 3NCHAF900CA series (contact angle : 20°)

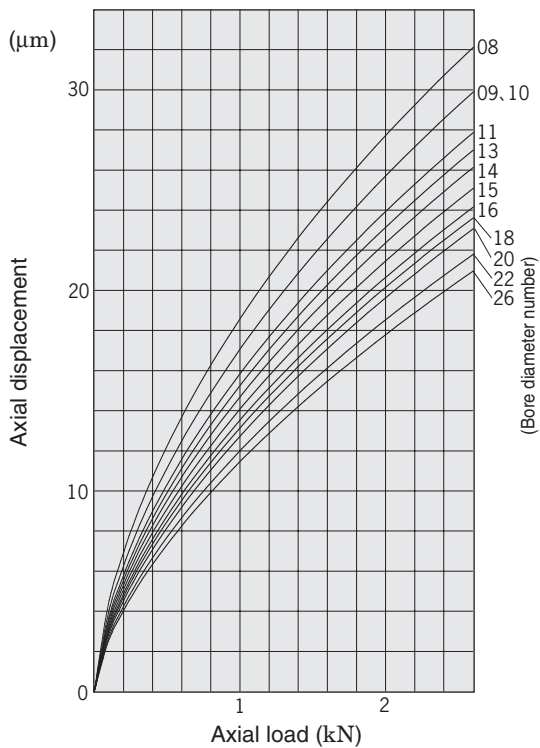

(24) 3NCHAF000CA series (contact angle : 20°)

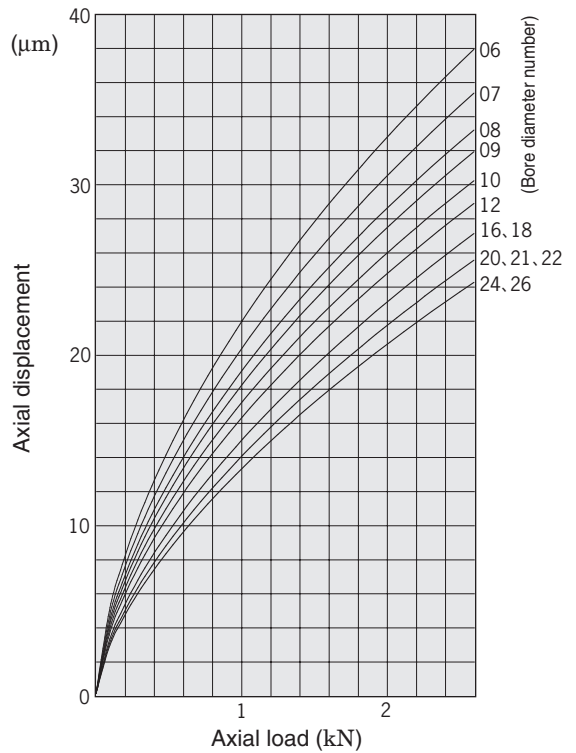
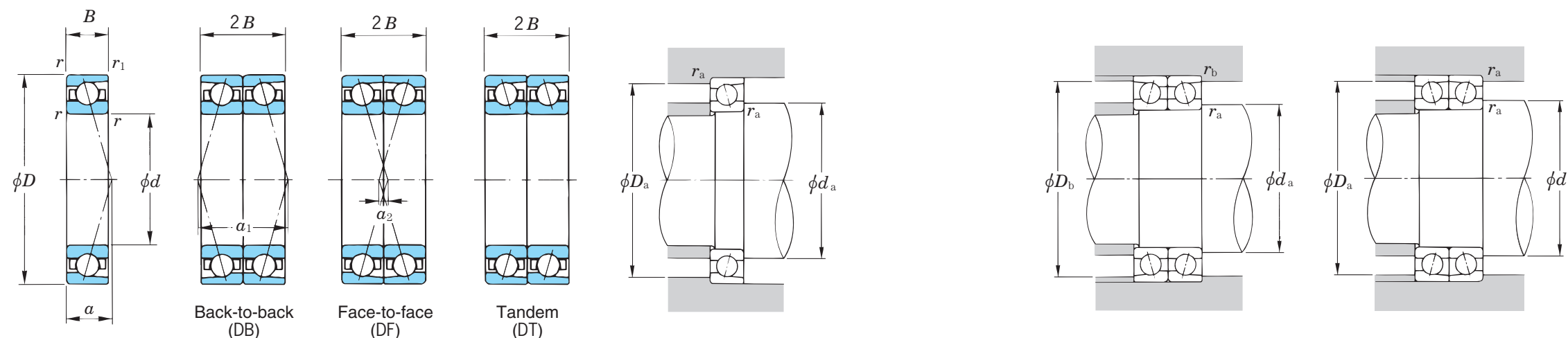

Fig. 1. 4 (6) Relationships between axial load and displacement (angular contact ball bearings)

*The axial displacements shown above are values of the single-row bearings not preloaded.

7000C series

Contact angle 15°



Static equivalent load $P_0 = X_0 F_r + Y_0 F_a$

Contact angle	Single row/ Tandem		Back-to-back/ Face-to-face	
	X_0	Y_0	X_0	Y_0
15°	0.5	0.46	1	0.92

Note that in the case of single row or tandem, assume $P_0 = F_r$ if $P_0 < F_r$.

Dynamic equivalent load $P = X F_r + Y F_a$

Contact angle	$i f_0 F_a / C_{0r}$	e	Single row/Tandem				Back-to-back/Face-to-face			
			$F_a / F_r \leq e$		$F_a / F_r > e$		$F_a / F_r \leq e$		$F_a / F_r > e$	
			X	Y	X	Y	X	Y	X	Y
15°	0.178	0.38			1.47		1.65		2.39	
	0.357	0.40			1.40		1.57		2.28	
	0.714	0.43			1.30		1.46		2.11	
	1.07	0.46			1.23		1.38		2.00	
	1.43	0.47	1	0	0.44	1	1.34	0.72	1.93	
	2.14	0.50			1.12		1.26		1.82	
	3.57	0.55			1.02		1.14		1.66	
	5.35	0.56			1.00		1.12		1.63	
	7.14	0.56			1.00		1.12		1.63	

1) For i , use 2 for DB & DF and 1 for single & DT.

Boundary dimensions (mm)					Bearing No.	Basic load ratings (kN)		Factor f_0	Limiting speeds (min ⁻¹)		Load center (mm) a	Interspace volume (cm ³ /row)	(Refer.) Mass (kg/row)	Permissible axial loads (kN) (static)	Load center spread of pair-mounted bearings (mm)		Mounting dimensions (mm)					Nut axial tension (N)	Interference of retaining plate (mm)	Bearing No.
d	D	B	$r_{\min.}$	$r_{1\min.}$		C_r	C_{0r}		Grease lub.	Oil lub.					a_1	a_2	d_a min.	D_a max.	D_b max.	r_a max.	r_b max.			
10	26	8	0.3	0.15	7000C	5.30	2.45	12.5	48 000	76 000	6.4	0.89	0.021	1.90	12.7	3.3	12.5	23.5	24.8	0.3	0.15	2 000	0.01~0.02	7000C
12	28	8	0.3	0.15	7001C	5.80	2.95	13.4	41 000	66 000	6.7	1.1	0.024	1.97	13.5	2.5	14.5	25.5	26.8	0.3	0.15	2 000	0.01~0.02	7001C
15	32	9	0.3	0.15	7002C	6.60	3.70	14.1	36 000	57 000	7.6	1.3	0.035	2.84	15.3	2.7	17.5	29.5	30.8	0.3	0.15	3 000	0.01~0.02	7002C
17	35	10	0.3	0.15	7003C	7.30	4.45	14.6	32 000	51 000	8.6	1.8	0.045	2.90	17.1	2.9	19.5	32.5	33.8	0.3	0.15	3 000	0.01~0.02	7003C
20	42	12	0.6	0.3	7004C	11.1	6.60	14.1	27 000	43 000	10.2	3.2	0.079	3.40	20.4	3.6	24.5	37.5	39.5	0.6	0.3	5 000	0.01~0.02	7004C
25	47	12	0.6	0.3	7005C	12.3	8.00	14.7	24 000	37 000	10.8	3.6	0.091	3.98	21.7	2.3	29.5	42.5	44.5	0.6	0.3	5 000	0.01~0.02	7005C
30	55	13	1	0.6	7006C	15.8	11.0	14.9	20 000	32 000	12.2	4.9	0.133	5.34	24.4	1.6	35.5	49.5	50.5	1	0.6	5 000	0.01~0.02	7006C
35	62	14	1	0.6	7007C	19.1	13.7	15.0	17 000	28 000	13.5	7.0	0.170	6.63	27.0	1.0	40.5	56.5	57.5	1	0.6	8 000	0.01~0.02	7007C
40	68	15	1	0.6	7008C	20.5	15.9	15.4	16 000	25 000	14.8	8.8	0.210	7.53	29.5	0.5	45.5	62.5	63.5	1	0.6	8 000	0.01~0.02	7008C
45	75	16	1	0.6	7009C	24.4	19.3	15.4	14 000	22 000	16.0	11	0.260	9.14	32.1	0.1	50.5	69.5	70.5	1	0.6	10 000	0.01~0.02	7009C
50	80	16	1	0.6	7010C	26.0	21.9	15.7	13 000	21 000	16.8	12	0.290	10.2	33.6	1.6	55.5	74.5	75.5	1	0.6	10 000	0.01~0.02	7010C
55	90	18	1.1	0.6	7011C	34.1	28.6	15.5	12 000	19 000	18.7	17	0.420	13.3	37.4	1.4	62	83	85.5	1	0.6	12 000	0.01~0.02	7011C
60	95	18	1.1	0.6	7012C	35.0	30.6	15.7	11 000	17 000	19.4	19	0.450	13.5	38.8	2.8	67	88	90.5	1	0.6	12 000	0.01~0.02	7012C
65	100	18	1.1	0.6	7013C	37.1	34.3	15.9	10 000	16 000	20.1	19	0.470	18.7	40.2	4.2	72	93	95.5	1	0.6	15 000	0.01~0.02	7013C
70	110	20	1.1	0.6	7014C	46.9	43.0	15.7	9 400	15 000	22.1	27	0.660	21.0	44.1	4.1	77	103	105.5	1	0.6	15 000	0.01~0.02	7014C
75	115	20	1.1	0.6	7015C	48.0	45.6	15.9	8 900	14 000	22.7	29	0.690	22.0	45.5	5.5	82	108	110.5	1	0.6	15 000	0.01~0.02	7015C
80	125	22	1.1	0.6	7016C	58.7	55.3	15.7	8 200	13 000	24.7	37	0.930	23.5	49.5	5.5	87	118	120.5	1	0.6	15 000	0.01~0.02	7016C
85	130	22	1.1	0.6	7017C	60.1	58.7	15.9	7 700	12 000	25.5	39	0.970	28.2	51.1	7.1	92	123	125.5	1	0.6	18 000	0.01~0.02	7017C
90	140	24	1.5	1	7018C	71.7	69.1	15.7	7 300	12 000	27.4	47	1.26	37.3	54.8	6.8	98.5	131.5	134.5	1.5	1	18 000	0.01~0.02	7018C
95	145	24	1.5	1	7019C	73.4	73.4	15.9	6 900	11 000	28.3	50	1.32	37.8	56.7	8.7	103.5	136.5	139.5	1.5	1	18 000	0.01~0.02	7019C
100	150	24	1.5	1	7020C	75.3	77.2	16.0	6 700	11 000	28.7	51	1.37	38.1	57.5	9.5	108.5	141.5	144.5	1.5	1	20 000	0.01~0.02	7020C
105	160	26	2	1	7021C	87.8	89.6	15.9	6 200	9 800	31.0	68	1.73	48.9	62.0	10.0	115	150	154.5	2	1	20 000	0.02~0.04	7021C
110	170	28	2	1	7022C	101	101	15.7	5 900	9 400	32.8	80	2.14	50.3	65.5	9.5	120	160	164.5	2	1	20 000	0.02~0.04	7022C
120	180	28	2	1	7024C	106	113	16.0	5 500	8 700	34.1	85	2.27	60.8	68.2	12.2	130	170	174.5	2	1	20 000	0.02~0.04	7024C
130	200	33	2	1	7026C	129	137	15.9	5 000	7 900	38.6	130	3.43	74.7	77.2	11.2	140	190	194.5	2	1	20 000	0.02~0.04	7026C
140	210	33	2	1	7028C	132	145	16.0	4 700	7 400	39.9	137	3.64	78.3	79.9	13.9	150	200	204.5	2	1	25 000	0.02~0.04	7028C
150	225	35	2.1	1.1	7030C	151	169	16.1	4 300	6 800	42.8	169	4.43	89.9	85.6	15.6	162	213	218	2	1	25 000	0.02~0.04	7030C
160	240	38	2.1	1.1	7032C	171	193	16.0	4 000	6 400	45.8	232	5.45	111	91.6	15.6	172	228	233	2	1	30 000	0.02~0.04	7032C
170	260	42	2.1	1.1	7034C	204	234	15.9	3 700	5 800	49.8	301	7.57	128	99.6	15.6	182	248	253	2	1	30 000	0.02~0.04	7034C
180	280	46	2.1	1.1	7036C	233	276	15.7	3 400	5 400	53.8	363	9.96	154	107.6	15.6	192	268	273	2	1	30 000	0.02~0.04	7036C
190	290	46	2.1	1.1	7038C	239	293	15.9	3 200	5 100	55.2	351	10.8	163	110.3	18.3	202	278	283	2	1	35 000	0.02~0.04	7038C
200	310	51	2.1	1.1	7040C	268	338	15.7	3 000	4 800	59.7	505	12.7	170	119.3	17.3	212	298	303	2	1	35 000	0.02~0.04	7040C

- [Remarks] 1. For the dimensions of the spacers for oil / air lubrication, refer to Table 9. 4(1) on page 37.
2. For the discharge intervals of the oil / air, refer to Supplementary table 6 on page 219.

Basic load ratings in case of multiple-row combination bearing

	Basic dynamic load ratings	Basic static load ratings
2-row	$C_r \times 1.62$	$C_{0r} \times 2$
3-row	$C_r \times 2.16$	$C_{0r} \times 3$
4-row	$C_r \times 2.64$	$C_{0r} \times 4$

Speed coefficients in case of multiple-row combination bearing

Combination types	Combination symbols	Preload when mounting			
		Preload S	Preload L	Preload M	Preload H
○ ○	DB	0.85	0.80	0.65	0.55
○ ○ ○ ○	DBB	0.80	0.75	0.60	0.45
○ ○ ○ ○ ○	DBD	0.75	0.70	0.55	0.40

*Speed coefficients also vary depending on the distance of bearings.

1. Angular contact ball bearings

7000 series

Contact angle 30°

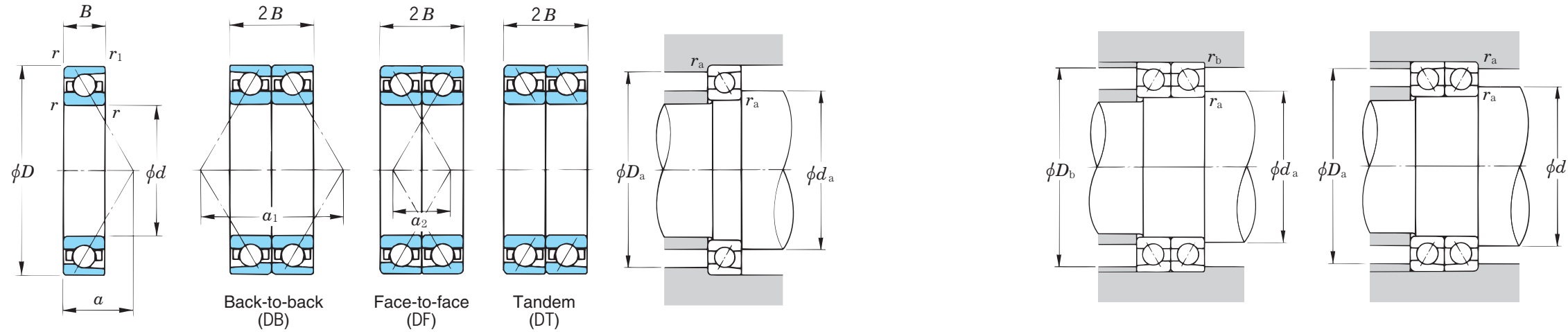

Static equivalent load $P_0 = X_0 F_r + Y_0 F_a$

Contact angle	Single row/Tandem		Back-to-back/Face-to-face	
	X_0	Y_0	X_0	Y_0
30°	0.5	0.33	1	0.66

Note that in the case of single row or tandem, assume $P_0 = F_r$ if $P_0 < F_r$.

Dynamic equivalent load $P = X F_r + Y F_a$

Contact angle	e	Single row/Tandem				Back-to-back/Face-to-face			
		$\frac{F_a}{F_r} \leq e$		$\frac{F_a}{F_r} > e$		$\frac{F_a}{F_r} \leq e$		$\frac{F_a}{F_r} > e$	
		X	Y	X	Y	X	Y	X	Y
30°	0.80	1	0	0.39	0.76	1	0.78	0.63	1.24

d	Boundary dimensions (mm)				Bearing No.	Basic load ratings (kN)		Limiting speeds (min ⁻¹)		Load center (mm) a	Interspace volume (cm ³ /row)	(Refer.) Mass (kg/row)	Permissible axial loads (kN) (static)	Load center spread of pair-mounted bearings (mm)		Mounting dimensions (mm)					Nut axial tension (N)	Interference of retaining plate (mm)	Bearing No.
	D	B	r min.	r ₁ min.		C _r	C _{0r}	Grease lub.	Oil lub.					a ₁	a ₂	d _a min.	D _a max.	D _b max.	r _a max.	r _b max.			
10	26	8	0.3	0.15	7000	5.00	2.35	37 000	48 000	9.1	0.86	0.021	0.70	18.2	2.2	12.5	23.5	24.8	0.3	0.15	2 000	0.01~0.02	7000
12	28	8	0.3	0.15	7001	5.40	2.75	32 000	41 000	9.9	1.1	0.024	0.74	19.9	3.9	14.5	25.5	26.8	0.3	0.15	2 000	0.01~0.02	7001
15	32	9	0.3	0.15	7002	6.10	3.45	28 000	36 000	11.3	1.3	0.035	1.00	22.6	4.6	17.5	29.5	30.8	0.3	0.15	3 000	0.01~0.02	7002
17	35	10	0.3	0.15	7003	6.75	4.15	25 000	32 000	12.7	1.6	0.045	1.03	25.3	5.3	19.5	32.5	33.8	0.3	0.15	3 000	0.01~0.02	7003
20	42	12	0.6	0.3	7004	10.3	6.10	21 000	27 000	15.1	3.2	0.079	1.65	30.2	6.2	24.5	37.5	39.5	0.6	0.3	5 000	0.01~0.02	7004
25	47	12	0.6	0.3	7005	11.3	7.40	18 000	24 000	16.4	3.6	0.091	1.94	32.9	8.9	29.5	42.5	44.5	0.6	0.3	5 000	0.01~0.02	7005
30	55	13	1	0.6	7006	14.5	10.1	15 000	20 000	18.8	4.9	0.133	2.60	37.5	11.5	35.5	49.5	50.5	1	0.6	5 000	0.01~0.02	7006
35	62	14	1	0.6	7007	17.5	12.6	13 000	17 000	21.2	6.9	0.170	3.22	42.3	14.3	40.5	56.5	57.5	1	0.6	8 000	0.01~0.02	7007
40	68	15	1	0.6	7008	18.7	14.6	12 000	16 000	23.2	8.7	0.210	3.66	46.3	16.3	45.5	62.5	63.5	1	0.6	8 000	0.01~0.02	7008
45	75	16	1	0.6	7009	22.2	17.7	11 000	14 000	25.3	11	0.260	4.44	50.7	18.7	50.5	69.5	70.5	1	0.6	10 000	0.01~0.02	7009
50	80	16	1	0.6	7010	23.6	20.1	9 900	13 000	26.9	12	0.290	4.97	53.8	21.8	55.5	74.5	75.5	1	0.6	10 000	0.01~0.02	7010
55	90	18	1.1	0.6	7011	31.1	26.3	9 000	12 000	29.9	17	0.420	6.35	59.9	23.9	62	83	85.5	1	0.6	12 000	0.01~0.02	7011
60	95	18	1.1	0.6	7012	31.9	28.1	8 400	11 000	31.4	19	0.450	6.37	62.8	26.8	67	88	90.5	1	0.6	12 000	0.01~0.02	7012
65	100	18	1.1	0.6	7013	33.7	31.4	7 800	10 000	33.0	19	0.470	9.89	65.9	29.9	72	93	95.5	1	0.6	15 000	0.01~0.02	7013
70	110	20	1.1	0.6	7014	42.7	39.4	7 200	9 400	36.0	27	0.660	10.4	72.0	32.0	77	103	105.5	1	0.6	15 000	0.01~0.02	7014
75	115	20	1.1	0.6	7015	43.6	41.7	6 800	8 900	37.4	28	0.690	10.6	74.9	34.9	82	108	110.5	1	0.6	15 000	0.01~0.02	7015
80	125	22	1.1	0.6	7016	53.4	50.6	6 300	8 200	40.6	37	0.930	10.8	81.2	37.2	87	118	120.5	1	0.6	15 000	0.01~0.02	7016
85	130	22	1.1	0.6	7017	54.6	53.7	5 900	7 700	42.3	39	0.970	14.0	84.7	40.7	92	123	125.5	1	0.6	18 000	0.01~0.02	7017
90	140	24	1.5	1	7018	65.2	63.3	5 600	7 300	45.2	47	1.26	19.0	90.4	42.4	98.5	131.5	134.5	1.5	1	18 000	0.01~0.02	7018
95	145	24	1.5	1	7019	66.6	67.1	5 200	6 900	47.2	50	1.32	19.1	94.5	46.5	103.5	136.5	139.5	1.5	1	18 000	0.01~0.02	7019
100	150	24	1.5	1	7020	68.4	70.6	5 100	6 700	48.1	51	1.37	19.2	96.2	48.2	108.5	141.5	144.5	1.5	1	20 000	0.01~0.02	7020
105	160	26	2	1	7021	79.8	81.9	4 700	6 200	51.8	68	1.73	25.0	103.7	51.7	115	150	154.5	2	1	20 000	0.02~0.04	7021
110	170	28	2	1	7022	91.9	92.8	4 500	5 900	54.4	80	2.14	25.2	108.9	52.9	120	160	164.5	2	1	20 000	0.02~0.04	7022
120	180	28	2	1	7024	96.6	103	4 200	5 500	57.3	78	2.27	31.9	114.6	58.6	130	170	174.5	2	1	20 000	0.02~0.04	7024
130	200	33	2	1	7026	117	125	3 800	5 000	64.1	129	3.43	39.4	128.3	62.3	140	190	194.5	2	1	20 000	0.02~0.04	7026
140	210	33	2	1	7028	120	133	3 600	4 600	67.0	136	3.64	41.3	134.1	68.1	150	200	204.5	2	1	25 000	0.02~0.04	7028
150	225	35	2.1	1.1	7030	137	154	3 300	4 300	72.1	168	4.43	47.1	144.2	74.2	162	213	218	2	1	25 000	0.02~0.04	7030
160	240	38	2.1	1.1	7032	155	176	3 100	4 000	76.8	232	5.45	60.7	153.5	77.5	172	228	233	2	1	30 000	0.02~0.04	7032
170	260	42	2.1	1.1	7034	186	214	2 800	3 700	83.1	301	7.58	67.8	166.2	82.2	182	248	253	2	1	30 000	0.02~0.04	7034
180	280	46	2.1	1.1	7036	212	253	2 600	3 400	89.4	363	10.1	82.3	178.8	86.8	192	268	273	2	1	30 000	0.02~0.04	7036
190	290	46	2.1	1.1	7038	217	268	2 500	3 200	92.3	351	10.8	87.0	184.6	92.6	202	278	283	2	1	35 000	0.02~0.04	7038
200	310	51	2.1	1.1	7040	244	309	2 300	3 000	99.1	506	12.7	90.7	198.3	96.3	212	298	303	2	1	35 000	0.02~0.04	7040

[Remarks] 1. For the dimensions of the spacers for oil / air lubrication, refer to Table 9. 4(1) on page 37.
2. For the discharge intervals of the oil / air, refer to Supplementary table 6 on page 219.

Basic load ratings in case of multiple-row combination bearing

	Basic dynamic load ratings	Basic static load ratings
2-row	$C_r \times 1.62$	$C_{0r} \times 2$
3-row	$C_r \times 2.16$	$C_{0r} \times 3$
4-row	$C_r \times 2.64$	$C_{0r} \times 4$

Speed coefficients in case of multiple-row combination bearing

Combination types	Combination symbols	Preload when mounting			
		Preload S	Preload L	Preload M	Preload H
⊗ ⊗	DB	0.85	0.80	0.65	0.55
⊗ ⊗ ⊗ ⊗	DBB	0.80	0.75	0.60	0.45
⊗ ⊗ ⊗ ⊗	DBD	0.75	0.70	0.55	0.40

*Speed coefficients also vary depending on the distance of bearings.

7200 series

Contact angle 30°

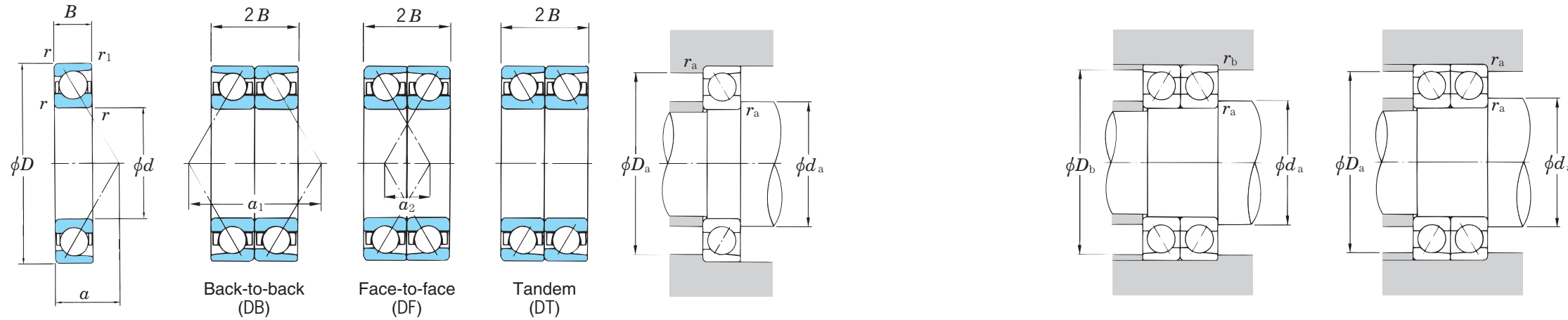

Static equivalent load $P_0 = X_0 F_r + Y_0 F_a$

Contact angle	Single row/Tandem		Back-to-back/Face-to-face	
	X_0	Y_0	X_0	Y_0
30°	0.5	0.33	1	0.66

Note that in the case of single row or tandem, assume $P_0 = F_r$ if $P_0 < F_r$.

Dynamic equivalent load $P = X F_r + Y F_a$

Contact angle	e	Single row/Tandem				Back-to-back/Face-to-face			
		$\frac{F_a}{F_r} \leq e$		$\frac{F_a}{F_r} > e$		$\frac{F_a}{F_r} \leq e$		$\frac{F_a}{F_r} > e$	
		X	Y	X	Y	X	Y	X	Y
30°	0.80	1	0	0.39	0.76	1	0.78	0.63	1.24

d	Boundary dimensions (mm)				Bearing No.	Basic load ratings (kN)		Limiting speeds (min ⁻¹)		Load center (mm) a	Interspace volume (cm ³ /row)	(Refer.) Mass (kg/row)	Permissible axial loads (kN) (static)	Load center spread of pair-mounted bearings (mm)		Mounting dimensions (mm)					Nut axial tension (N)	Interference of retaining plate (mm)	Bearing No.
	D	B	r min.	r ₁ min.		C _r	C _{0r}	Grease lub.	Oil lub.					a ₁	a ₂	d _a min.	D _a max.	D _b max.	r _a max.	r _b max.			
10	30	9	0.6	0.3	7200	4.65	2.20	32 000	41 000	10.4	1.3	0.031	1.00	20.8	2.8	14.5	25.5	27.5	0.6	0.3	3 000	0.01~0.02	7200
12	32	10	0.6	0.3	7201	7.45	3.65	30 000	39 000	11.4	1.7	0.038	1.05	22.7	2.7	16.5	27.5	29.5	0.6	0.3	3 000	0.01~0.02	7201
15	35	11	0.6	0.3	7202	8.10	4.25	25 000	33 000	12.9	2.3	0.048	1.10	25.7	3.7	19.5	30.5	32.5	0.6	0.3	5 000	0.01~0.02	7202
17	40	12	0.6	0.3	7203	10.2	5.50	22 000	29 000	14.4	3.1	0.070	1.86	28.8	4.8	21.5	35.5	37.5	0.6	0.3	5 000	0.01~0.02	7203
20	47	14	1	0.6	7204	14.5	8.40	19 000	25 000	17.0	5.2	0.112	2.34	33.9	5.9	25.5	41.5	42.5	1	0.6	5 000	0.01~0.02	7204
25	52	15	1	0.6	7205	15.3	9.50	17 000	22 000	18.8	6.5	0.135	2.56	37.5	7.5	30.5	46.5	47.5	1	0.6	8 000	0.01~0.02	7205
30	62	16	1	0.6	7206	21.3	13.7	14 000	18 000	21.5	9.3	0.208	3.70	43.0	11.0	35.5	56.5	57.5	1	0.6	8 000	0.01~0.02	7206
35	72	17	1.1	0.6	7207	28.1	18.6	12 000	16 000	24.2	13	0.295	5.43	48.5	14.5	42	65	67.5	1	0.6	8 000	0.01~0.02	7207
40	80	18	1.1	0.6	7208	33.6	23.3	11 000	14 000	26.3	15	0.382	8.31	52.7	16.7	47	73	75.5	1	0.6	10 000	0.01~0.02	7208
45	85	19	1.1	0.6	7209	37.7	26.6	10 000	13 000	28.0	18	0.430	8.74	56.0	18.0	52	78	80.5	1	0.6	10 000	0.01~0.02	7209
50	90	20	1.1	0.6	7210	39.4	29.4	9 200	12 000	30.4	22	0.485	9.44	60.7	20.7	57	83	85.5	1	0.6	12 000	0.01~0.02	7210
55	100	21	1.5	1	7211	48.7	37.1	8 200	11 000	33.3	29	0.635	12.4	66.6	24.6	63.5	91.5	94.5	1.5	1	12 000	0.01~0.02	7211
60	110	22	1.5	1	7212	58.9	45.7	7 400	9 700	36.1	36	0.820	15.7	72.3	28.3	68.5	101.5	104.5	1.5	1	15 000	0.01~0.02	7212
65	120	23	1.5	1	7213	67.3	54.2	7 000	9 100	38.2	40	1.02	18.3	76.4	30.4	73.5	111.5	114.5	1.5	1	15 000	0.01~0.02	7213
70	125	24	1.5	1	7214	69.8	55.6	6 600	8 600	40.2	48	1.12	18.6	80.3	32.3	78.5	116.5	119.5	1.5	1	15 000	0.01~0.02	7214
75	130	25	1.5	1	7215	79.2	65.2	6 300	8 200	42.1	53	1.23	21.6	84.2	34.2	83.5	121.5	124.5	1.5	1	15 000	0.01~0.02	7215
80	140	26	2	1	7216	85.3	71.5	5 800	7 600	44.8	63	1.50	23.3	89.5	37.5	90	130	134.5	2	1	18 000	0.01~0.02	7216
85	150	28	2	1	7217	98.6	83.6	5 400	7 100	47.9	75	1.87	27.9	95.9	39.9	95	140	144.5	2	1	18 000	0.01~0.02	7217
90	160	30	2	1	7218	113	96.7	5 100	6 700	51.1	92	2.30	33.0	102.2	42.2	100	150	154.5	2	1	20 000	0.01~0.02	7218
95	170	32	2.1	1.1	7219	122	103	4 800	6 300	54.3	115	2.78	34.8	108.5	44.5	107	158	163	2	1	20 000	0.01~0.02	7219
100	180	34	2.1	1.1	7220	137	117	4 500	5 900	57.7	139	3.32	39.0	115.4	47.4	112	168	173	2	1	25 000	0.01~0.02	7220
105	190	36	2.1	1.1	7221	149	132	4 200	5 500	61.0	171	3.95	44.8	122.1	50.1	117	178	183	2	1	30 000	0.02~0.04	7221
110	200	38	2.1	1.1	7222	162	148	4 000	5 200	64.3	202	4.65	50.9	128.7	52.7	122	188	193	2	1	30 000	0.02~0.04	7222
120	215	40	2.1	1.1	7224	174	166	3 700	4 900	68.5	240	5.49	57.5	137.0	57.0	132	203	208	2	1	30 000	0.02~0.04	7224
130	230	40	3	1.1	7226	196	198	3 400	4 500	72.0	257	6.21	62.1	143.9	63.9	144	216	223	2.5	1	30 000	0.02~0.04	7226
140	250	42	3	1.1	7228	218	234	3 100	4 100	77.3	300	7.76	72.8	154.6	70.6	154	236	243	2.5	1	35 000	0.02~0.04	7228
150	270	45	3	1.1	7230	248	280	2 900	3 800	83.1	304	9.75	84.9	166.3	76.3	164	256	263	2.5	1	35 000	0.02~0.04	7230
160	290	48	3	1.1	7232	230	263	2 700	3 500	89.0	358	12.1	86.3	177.9	81.9	174	276	283	2.5	1	40 000	0.02~0.04	7232
170	310	52	4	1.5	7234	272	331	2 500	3 200	95.3	463	15.1	107	190.6	86.6	188	292	301.5	3	1.5	40 000	0.02~0.04	7234
180	320	52	4	1.5	7236	293	362	2 300	3 100	98.2	588	15.7	120	196.3	92.3	198	302	311.5	3	1.5	40 000	0.02~0.04	7236
190	340	55	4	1.5	7238	303	390	2 200	2 900	104.0	669	18.8	128	208.0	98.0	208	322	331.5	3	1.5	40 000	0.02~0.04	7238
200	360	58	4	1.5	7240	324	423	2 000	2 700	109.8	817	22.4	287	219.7	103.7	218	342	351.5	3	1.5	40 000	0.02~0.04	7240

[Remarks] 1. For the dimensions of the spacers for oil / air lubrication, refer to Table 9. 4(1) on page 37.
2. For the discharge intervals of the oil / air, refer to Supplementary table 6 on page 219.

Basic load ratings in case of multiple-row combination bearing

	Basic dynamic load ratings	Basic static load ratings
2-row	$C_r \times 1.62$	$C_{0r} \times 2$
3-row	$C_r \times 2.16$	$C_{0r} \times 3$
4-row	$C_r \times 2.64$	$C_{0r} \times 4$

Speed coefficients in case of multiple-row combination bearing

Combination types	Combination symbols	Preload when mounting			
		Preload S	Preload L	Preload M	Preload H
	DB	0.85	0.80	0.65	0.55
	DBB	0.80	0.75	0.60	0.45
	DBD	0.75	0.70	0.55	0.40

*Speed coefficients also vary depending on the distance of bearings.

1. Angular contact ball bearings

High Ability

HAR900C series

Contact angle 15°

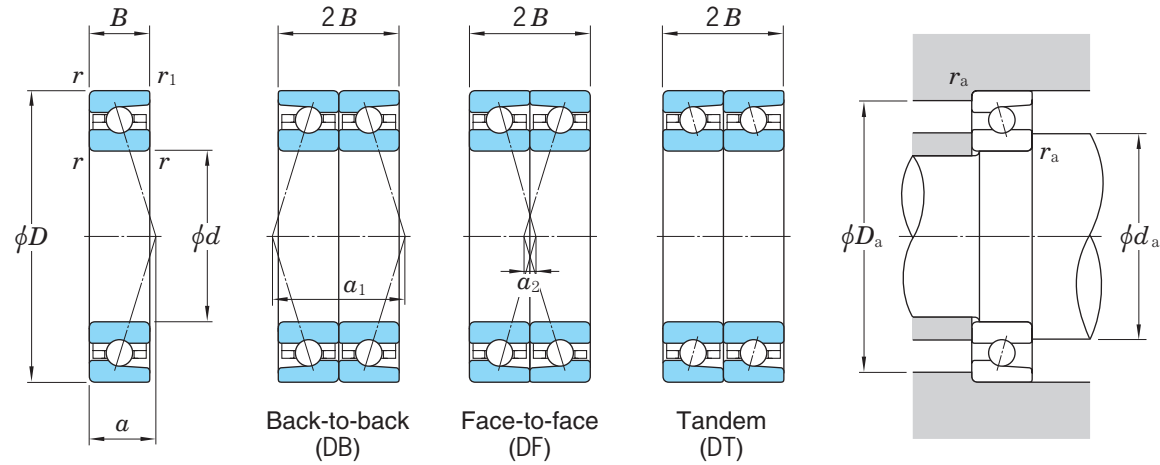

Static equivalent load $P_0 = X_0 F_r + Y_0 F_a$

Contact angle	Single row/Tandem		Back-to-back/Face-to-face	
	X_0	Y_0	X_0	Y_0
15°	0.5	0.46	1	0.92

Note that in the case of single row or tandem, assume $P_0 = F_r$, if $P_0 < F_r$.

Dynamic equivalent load $P = X F_r + Y F_a$

Contact angle	$i f_0 F_a / C_{0r}$	e	Single row/Tandem				Back-to-back/Face-to-face				
			$F_a / F_r \leq e$		$F_a / F_r > e$		$F_a / F_r \leq e$		$F_a / F_r > e$		
			X	Y	X	Y	X	Y	X	Y	
15°	0.178	0.38			1.47			1.65			2.39
	0.357	0.40			1.40			1.57			2.28
	0.714	0.43			1.30			1.46			2.11
	1.07	0.46			1.23			1.38			2.00
	1.43	0.47	1	0	0.44	1	1.34	0.72	1.93		
	2.14	0.50			1.12			1.26			1.82
	3.57	0.55			1.02			1.14			1.66
	5.35	0.56			1.00			1.12			1.63
	7.14	0.56			1.00			1.12			1.63

1) For i , use 2 for DB & DF and 1 for single & DT.

Boundary dimensions (mm)					Bearing No.	Basic load ratings (kN)		Factor f_0	Limiting speeds (min ⁻¹)		Load center (mm) a	Interspace volume (cm ³ /row)	(Refer.) Mass (kg/row)	Permissible axial loads (kN) (static)	Load center spread of pair-mounted bearings (mm)		Mounting dimensions (mm)					Nut axial tension (N)	Interference of retaining plate (mm)	Bearing No.
d	D	B	$r_{min.}$	$r_{1 min.}$		C_r	C_{0r}		Grease lub.	Oil lub.					a_1	a_2	d_a min.	D_a max.	D_b max.	r_a max.	r_b max.			
40	62	12	0.6	0.3	HAR908C	6.35	4.05	8.4	22 000	33 000	12.8	4.1	0.115	5.18	25.7	1.7	44.5	57.5	59.5	0.6	0.3	5 000	0.01~0.02	HAR908C
45	68	12	0.6	0.3	HAR909C	6.80	4.70	8.5	19 000	30 000	13.6	4.6	0.136	5.97	27.1	3.1	49.5	63.5	65.5	0.6	0.3	6 000	0.01~0.02	HAR909C
50	72	12	0.6	0.3	HAR910C	9.10	6.30	8.5	18 000	28 000	14.2	5.6	0.131	8.06	28.3	4.3	54.5	67.5	69.5	0.6	0.3	6 000	0.01~0.02	HAR910C
55	80	13	1	0.6	HAR911C	10.1	7.65	8.6	16 000	25 000	15.5	6.5	0.189	9.80	31.1	5.1	60.5	74.5	75.5	1	0.6	6 000	0.01~0.02	HAR911C
60	85	13	1	0.6	HAR912C	9.95	7.75	8.6	15 000	23 000	16.2	7.0	0.202	9.89	32.4	6.4	65.5	79.5	80.5	1	0.6	8 000	0.01~0.02	HAR912C
65	90	13	1	0.6	HAR913C	11.8	9.45	8.6	14 000	22 000	16.9	7.9	0.212	12.0	33.8	7.8	70.5	84.5	85.5	1	0.6	8 000	0.01~0.02	HAR913C
70	100	16	1	0.6	HAR914C	12.9	10.5	8.7	13 000	20 000	19.4	12	0.356	13.3	38.8	6.8	75.5	94.5	95.5	1	0.6	10 000	0.01~0.02	HAR914C
75	105	16	1	0.6	HAR915C	13.3	11.2	8.7	12 000	19 000	20.1	12	0.370	14.3	40.1	8.1	80.5	99.5	100.5	1	0.6	10 000	0.01~0.02	HAR915C
80	110	16	1	0.6	HAR916C	13.6	11.9	8.8	12 000	18 000	20.7	13	0.398	15.2	41.5	9.5	85.5	104.5	105.5	1	0.6	10 000	0.01~0.02	HAR916C
85	120	18	1.1	0.6	HAR917C	16.3	14.2	8.7	10 000	16 000	22.7	18	0.570	18.1	45.5	9.5	92	113	115.5	1	0.6	12 000	0.01~0.02	HAR917C
90	125	18	1.1	0.6	HAR918C	16.8	15.1	8.8	9 700	15 000	23.4	19	0.598	19.3	46.8	10.8	97	118	120.5	1	0.6	12 000	0.01~0.02	HAR918C
95	130	18	1.1	0.6	HAR919C	17.3	16.0	8.8	9 300	14 000	24.1	19	0.626	20.5	48.1	12.1	102	123	125.5	1	0.6	12 000	0.01~0.02	HAR919C
100	140	20	1.1	0.6	HAR920C	24.2	21.7	8.7	8 700	13 000	26.1	28	0.839	27.8	52.2	12.2	107	133	135.5	1	0.6	15 000	0.01~0.02	HAR920C
105	145	20	1.1	0.6	HAR921C	24.9	23.1	8.7	8 400	13 000	26.7	29	0.874	29.6	53.5	13.5	112	138	140.5	1	0.6	15 000	0.02~0.04	HAR921C
110	150	20	1.1	0.6	HAR922C	25.1	23.8	8.7	8 000	12 000	27.4	30	0.909	30.5	54.8	14.8	117	143	145.5	1	0.6	15 000	0.02~0.04	HAR922C
120	165	22	1.1	0.6	HAR924C	29.4	28.4	8.8	7 300	11 000	30.1	40	1.25	36.3	60.2	16.2	127	158	160.5	1	0.6	15 000	0.02~0.04	HAR924C
130	180	24	1.5	1	HAR926C	35.1	35.1	8.8	6 700	10 000	32.8	51	1.66	44.9	65.5	17.5	138.5	171.5	174.5	1.5	1	20 000	0.02~0.04	HAR926C
140	190	24	1.5	1	HAR928C	35.2	36.2	8.8	6 300	9 800	34.1	57	1.76	46.3	68.2	20.2	148.5	181.5	184.5	1.5	1	20 000	0.02~0.04	HAR928C
150	210	28	2	1	HAR930C	48.9	48.9	8.7	5 800	9 000	38.1	85	2.68	62.5	76.2	20.2	160	200	204.5	2	1	20 000	0.02~0.04	HAR930C
160	220	28	2	1	HAR932C	50.2	51.8	8.8	5 200	8 100	39.5	90	2.83	66.3	78.9	22.9	170	210	214.5	2	1	25 000	0.02~0.04	HAR932C
170	230	28	2	1	HAR934C	51.4	54.8	8.8	5 000	7 700	40.8	94	2.97	70.2	81.6	25.6	180	220	224.5	2	1	25 000	0.02~0.04	HAR934C

- [Remarks]
- Boundary dimensions of this bearing are the same as those of the 7900 series.
 - For the dimensions of the spacers for oil / air lubrication, refer to Table 9. 4(2) on page 38.
 - For the discharge intervals of the oil / air, refer to Supplementary table 6 on page 219.

Basic load ratings in case of multiple-row combination bearing

	Basic dynamic load ratings	Basic static load ratings
2-row	$C_r \times 1.62$	$C_{0r} \times 2$
3-row	$C_r \times 2.16$	$C_{0r} \times 3$
4-row	$C_r \times 2.64$	$C_{0r} \times 4$

Speed coefficients in case of multiple-row combination bearing

Combination types	Combination symbols	Preload when mounting			
		Preload S	Preload L	Preload M	Preload H
⊘ ⊘	DB	0.85	0.80	0.65	0.55
⊘ ⊘ ⊘ ⊘	DBB	0.80	0.75	0.60	0.45
⊘ ⊘ ⊘	DBD	0.75	0.70	0.55	0.40

*Speed coefficients also vary depending on the distance of bearings.

1. Angular contact ball bearings

High Ability

HAR900CA series

Contact angle 20°

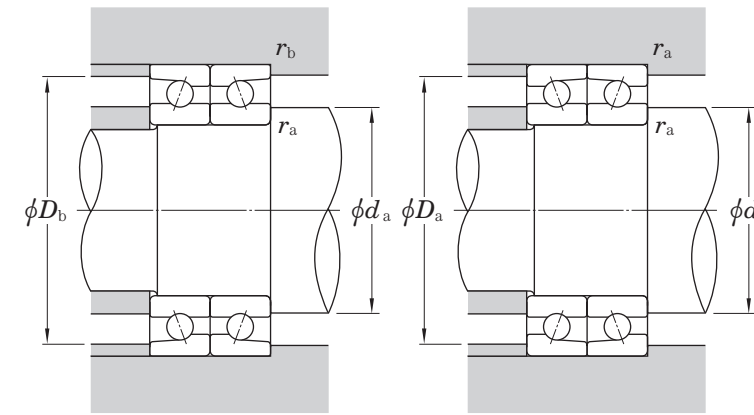
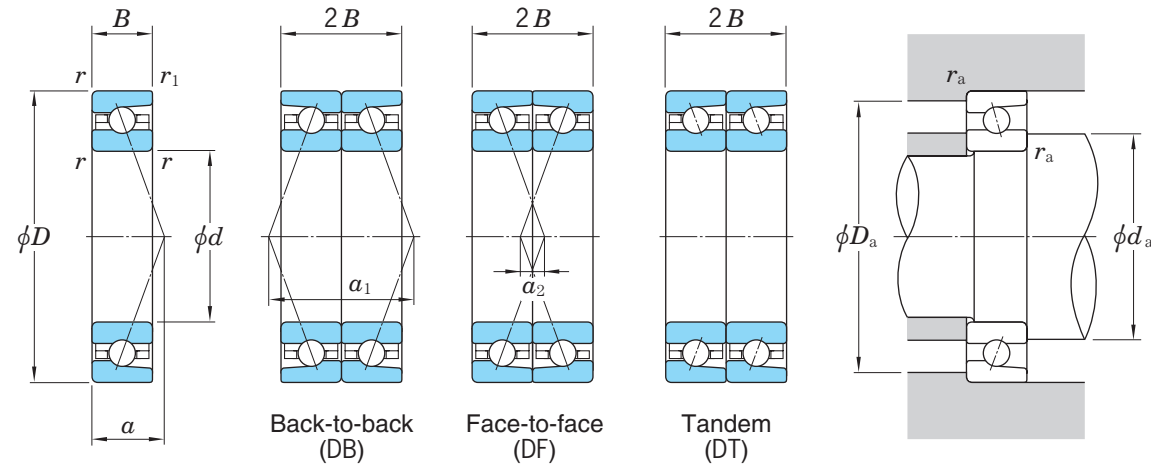

Static equivalent load $P_0 = X_0 F_r + Y_0 F_a$

Contact angle	Single row/Tandem		Back-to-back/Face-to-face	
	X_0	Y_0	X_0	Y_0
20°	0.5	0.42	1	0.84

Note that in the case of single row or tandem, assume $P_0 = F_r$ if $P_0 > F_r$.

Dynamic equivalent load $P = X F_r + Y F_a$

Contact angle	e	Single row/Tandem				Back-to-back/Face-to-face			
		$\frac{F_a}{F_r} \leq e$		$\frac{F_a}{F_r} > e$		$\frac{F_a}{F_r} \leq e$		$\frac{F_a}{F_r} > e$	
		X	Y	X	Y	X	Y	X	Y
20°	0.57	1	0	0.43	1	1	1.09	0.70	1.63

d	Boundary dimensions (mm)				Bearing No.	Basic load ratings (kN)		Limiting speeds (min ⁻¹)		Load center (mm) a	Interspace volume (cm ³ /row)	(Refer.) Mass (kg/row)	Permissible axial loads (kN) (static)	Load center spread of pair-mounted bearings (mm)		Mounting dimensions (mm)					Nut axial tension (N)	Interference of retaining plate (mm)	Bearing No.
	D	B	r min.	r ₁ min.		C _r	C _{0r}	Grease lub.	Oil lub.					a ₁	a ₂	d _a min.	D _a max.	D _b max.	r _a max.	r _b max.			
40	62	12	0.6	0.3	HAR908CA	6.20	3.95	21 000	31 000	15.3	4.1	0.115	6.08	30.6	6.6	44.5	57.5	59.5	0.6	0.3	5 000	0.01~0.02	HAR908CA
45	68	12	0.6	0.3	HAR909CA	6.65	4.55	19 000	28 000	16.3	4.6	0.136	7.00	32.6	8.6	49.5	63.5	65.5	0.6	0.3	6 000	0.01~0.02	HAR909CA
50	72	12	0.6	0.3	HAR910CA	8.90	6.15	17 000	26 000	17.1	5.6	0.131	9.13	34.2	10.2	54.5	67.5	69.5	0.6	0.3	6 000	0.01~0.02	HAR910CA
55	80	13	1	0.6	HAR911CA	9.85	7.50	16 000	24 000	18.8	6.5	0.189	10.7	37.6	11.6	60.5	74.5	75.5	1	0.6	6 000	0.01~0.02	HAR911CA
60	85	13	1	0.6	HAR912CA	9.70	7.55	14 000	22 000	19.7	7.0	0.202	11.5	39.4	13.4	65.5	79.5	80.5	1	0.6	8 000	0.01~0.02	HAR912CA
65	90	13	1	0.6	HAR913CA	11.5	9.25	14 000	21 000	20.6	7.9	0.212	14.1	41.2	15.2	70.5	84.5	85.5	1	0.6	8 000	0.01~0.02	HAR913CA
70	100	16	1	0.6	HAR914CA	12.6	10.2	12 000	19 000	23.5	12	0.356	15.6	46.9	14.9	75.5	94.5	95.5	1	0.6	10 000	0.01~0.02	HAR914CA
75	105	16	1	0.6	HAR915CA	12.9	10.9	12 000	18 000	24.4	12	0.370	16.7	48.8	16.8	80.5	99.5	100.5	1	0.6	10 000	0.01~0.02	HAR915CA
80	110	16	1	0.6	HAR916CA	13.3	11.6	11 000	17 000	25.3	13	0.398	17.8	50.6	18.6	85.5	104.5	105.5	1	0.6	10 000	0.01~0.02	HAR916CA
85	120	18	1.1	0.6	HAR917CA	15.9	13.8	9 700	15 000	27.7	18	0.570	21.2	55.3	19.3	92	113	115.5	1	0.6	12 000	0.01~0.02	HAR917CA
90	125	18	1.1	0.6	HAR918CA	16.4	14.7	9 300	14 000	28.6	19	0.598	22.6	57.1	21.1	97	118	120.5	1	0.6	12 000	0.01~0.02	HAR918CA
95	130	18	1.1	0.6	HAR919CA	16.9	15.6	8 900	14 000	29.5	19	0.626	23.9	58.9	22.9	102	123	125.5	1	0.6	12 000	0.01~0.02	HAR919CA
100	140	20	1.1	0.6	HAR920CA	23.6	21.2	8 300	13 000	31.8	28	0.839	32.5	63.7	23.7	107	133	135.5	1	0.6	15 000	0.01~0.02	HAR920CA
105	145	20	1.1	0.6	HAR921CA	24.3	22.5	8 000	12 000	32.7	29	0.874	34.6	65.5	25.5	112	138	140.5	1	0.6	15 000	0.02~0.04	HAR921CA
110	150	20	1.1	0.6	HAR922CA	24.5	23.2	7 700	12 000	33.7	30	0.909	35.7	67.3	27.3	117	143	145.5	1	0.6	15 000	0.02~0.04	HAR922CA
120	165	22	1.1	0.6	HAR924CA	28.6	27.7	7 000	11 000	36.9	40	1.25	42.4	73.9	29.9	127	158	160.5	1	0.6	15 000	0.02~0.04	HAR924CA
130	180	24	1.5	1	HAR926CA	34.2	34.3	6 400	9 800	40.2	51	1.66	52.5	80.4	32.4	138.5	171.5	174.5	1.5	1	20 000	0.02~0.04	HAR926CA
140	190	24	1.5	1	HAR928CA	34.3	35.3	6 000	9 200	42.0	57	1.76	54.2	84.1	36.1	148.5	181.5	184.5	1.5	1	20 000	0.02~0.04	HAR928CA
150	210	28	2	1	HAR930CA	47.7	47.6	5 500	8 400	46.8	85	2.68	73.1	93.5	37.5	160	200	204.5	2	1	20 000	0.02~0.04	HAR930CA
160	220	28	2	1	HAR932CA	48.9	50.5	5 000	7 600	48.6	90	2.83	77.5	97.2	41.2	170	210	214.5	2	1	25 000	0.02~0.04	HAR932CA
170	230	28	2	1	HAR934CA	50.1	53.4	4 700	7 200	50.4	94	2.97	82.0	100.8	44.8	180	220	224.5	2	1	25 000	0.02~0.04	HAR934CA

- [Remarks]
- Boundary dimensions of this bearing are the same as those of the 7900 series.
 - For the dimensions of the spacers for oil / air lubrication, refer to Table 9. 4(2) on page 38.
 - For the discharge intervals of the oil / air, refer to Supplementary table 6 on page 219.

Basic load ratings in case of multiple-row combination bearing

	Basic dynamic load ratings	Basic static load ratings
2-row	$C_r \times 1.62$	$C_{0r} \times 2$
3-row	$C_r \times 2.16$	$C_{0r} \times 3$
4-row	$C_r \times 2.64$	$C_{0r} \times 4$

Speed coefficients in case of multiple-row combination bearing

Combination types	Combination symbols	Preload when mounting			
		Preload S	Preload L	Preload M	Preload H
⊘ ⊘	DB	0.85	0.80	0.65	0.55
⊘ ⊘ ⊘ ⊘	DBB	0.80	0.75	0.60	0.45
⊘ ⊘ ⊘	DBD	0.75	0.70	0.55	0.40

*Speed coefficients also vary depending on the distance of bearings.

1. Angular contact ball bearings

High Ability

HAR900 series

Contact angle 30°

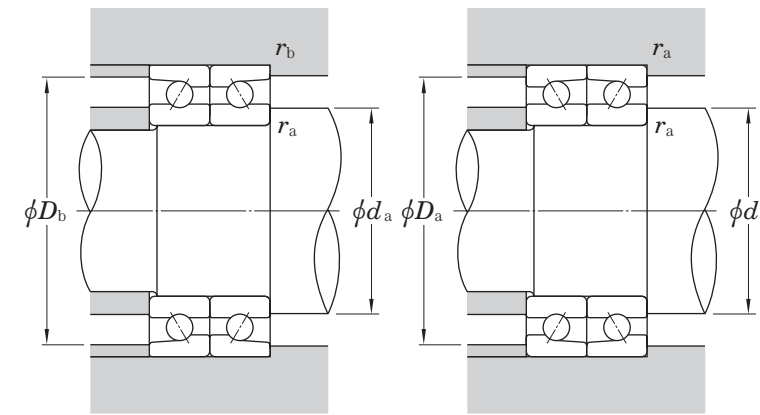
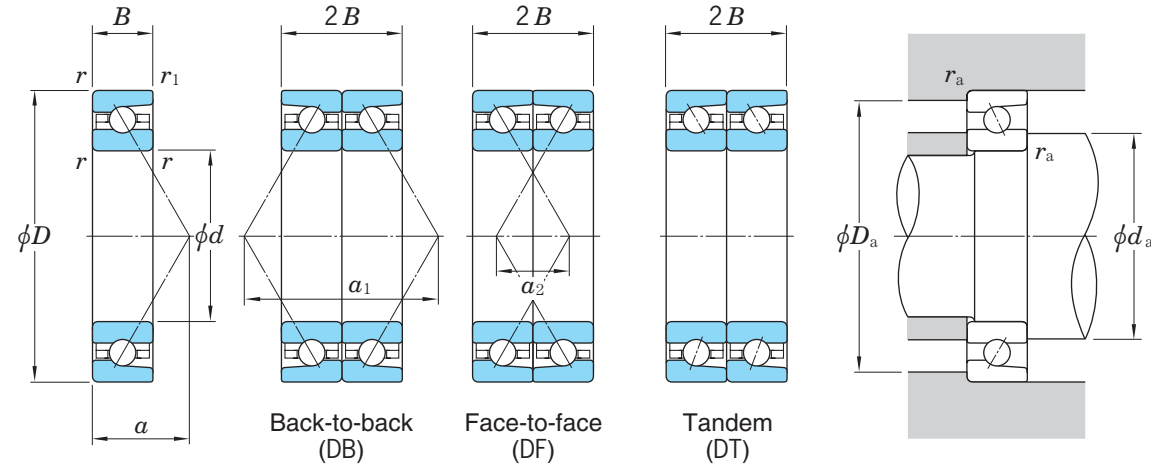

Static equivalent load $P_0 = X_0 F_r + Y_0 F_a$

Contact angle	Single row/Tandem		Back-to-back/Face-to-face	
	X_0	Y_0	X_0	Y_0
30°	0.5	0.33	1	0.66

Note that in the case of single row or tandem, assume $P_0 = F_r$ if $P_0 < F_r$.

Dynamic equivalent load $P = X F_r + Y F_a$

Contact angle	e	Single row/Tandem				Back-to-back/Face-to-face			
		$\frac{F_a}{F_r} \leq e$		$\frac{F_a}{F_r} > e$		$\frac{F_a}{F_r} \leq e$		$\frac{F_a}{F_r} > e$	
		X	Y	X	Y	X	Y	X	Y
30°	0.80	1	0	0.39	0.76	1	0.78	0.63	1.24

d	Boundary dimensions (mm)				Bearing No.	Basic load ratings (kN)		Limiting speeds (min ⁻¹)		Load center (mm) a	Interspace volume (cm ³ /row)	(Refer.) Mass (kg/row)	Permissible axial loads (kN) (static)	Load center spread of pair-mounted bearings (mm)		Mounting dimensions (mm)					Nut axial tension (N)	Interference of retaining plate (mm)	Bearing No.
	D	B	r min.	r ₁ min.		C _r	C _{0r}	Grease lub.	Oil lub.					a ₁	a ₂	d _a min.	D _a max.	D _b max.	r _a max.	r _b max.			
40	62	12	0.6	0.3	HAR908	5.75	3.70	15 000	20 000	20.7	4.1	0.115	4.79	41.4	17.4	44.5	57.5	59.5	0.6	0.3	5 000	0.01~0.02	HAR908
45	68	12	0.6	0.3	HAR909	6.15	4.25	13 000	18 000	22.3	4.6	0.136	5.14	44.6	20.6	49.5	63.5	65.5	0.6	0.3	6 000	0.01~0.02	HAR909
50	72	12	0.6	0.3	HAR910	8.25	5.75	12 000	16 000	23.6	5.6	0.131	5.16	47.2	23.2	54.5	67.5	69.5	0.6	0.3	6 000	0.01~0.02	HAR910
55	80	13	1	0.6	HAR911	9.15	6.95	11 000	15 000	26.0	6.5	0.189	8.84	52.0	26.0	60.5	74.5	75.5	1	0.6	6 000	0.01~0.02	HAR911
60	85	13	1	0.6	HAR912	9.00	7.00	10 000	14 000	27.4	7.0	0.202	9.95	54.9	28.9	65.5	79.5	80.5	1	0.6	8 000	0.01~0.02	HAR912
65	90	13	1	0.6	HAR913	10.7	8.55	9 700	13 000	28.9	7.9	0.212	11.2	57.7	31.7	70.5	84.5	85.5	1	0.6	8 000	0.01~0.02	HAR913
70	100	16	1	0.6	HAR914	11.7	9.45	8 800	12 000	32.5	12	0.356	12.9	65.1	33.1	75.5	94.5	95.5	1	0.6	10 000	0.01~0.02	HAR914
75	105	16	1	0.6	HAR915	12.0	10.1	8 300	11 000	34.0	12	0.370	13.8	68.0	36.0	80.5	99.5	100.5	1	0.6	10 000	0.01~0.02	HAR915
80	110	16	1	0.6	HAR916	12.3	10.8	7 900	11 000	35.4	13	0.398	14.6	70.8	38.8	85.5	104.5	105.5	1	0.6	10 000	0.01~0.02	HAR916
85	120	18	1.1	0.6	HAR917	14.8	12.8	7 000	9 300	38.6	18	0.570	17.0	77.2	41.2	92	113	115.5	1	0.6	12 000	0.01~0.02	HAR917
90	125	18	1.1	0.6	HAR918	15.2	13.7	6 600	8 800	40.0	19	0.598	18.0	80.1	44.1	97	118	120.5	1	0.6	12 000	0.01~0.02	HAR918
95	130	18	1.1	0.6	HAR919	15.6	14.5	6 300	8 400	41.5	19	0.626	19.0	83.0	47.0	102	123	125.5	1	0.6	12 000	0.01~0.02	HAR919
100	140	20	1.1	0.6	HAR920	21.9	19.7	5 900	7 900	44.6	28	0.839	27.5	89.3	49.3	107	133	135.5	1	0.6	15 000	0.01~0.02	HAR920
105	145	20	1.1	0.6	HAR921	22.5	20.9	5 700	7 600	46.1	29	0.874	29.1	92.2	52.2	112	138	140.5	1	0.6	15 000	0.02~0.04	HAR921
110	150	20	1.1	0.6	HAR922	22.8	21.6	5 500	7 300	47.5	30	0.909	29.9	95.1	55.1	117	143	145.5	1	0.6	15 000	0.02~0.04	HAR922
120	165	22	1.1	0.6	HAR924	26.6	25.7	5 000	6 700	52.1	40	1.25	34.8	104.3	60.3	127	158	160.5	1	0.6	15 000	0.02~0.04	HAR924
130	180	24	1.5	1	HAR926	31.7	31.8	4 600	6 100	56.7	51	1.66	42.3	113.5	65.5	138.5	171.5	174.5	1.5	1	20 000	0.02~0.04	HAR926
140	190	24	1.5	1	HAR928	31.8	32.8	4 300	5 800	59.6	57	1.76	43.3	119.3	71.3	148.5	181.5	184.5	1.5	1	20 000	0.02~0.04	HAR928
150	210	28	2	1	HAR930	44.3	44.2	4 000	5 300	66.0	85	2.68	60.3	131.9	75.9	160	200	204.5	2	1	20 000	0.02~0.04	HAR930
160	220	28	2	1	HAR932	45.4	46.9	3 600	4 700	68.8	90	2.83	63.6	137.7	81.7	170	210	214.5	2	1	25 000	0.02~0.04	HAR932
170	230	28	2	1	HAR934	46.4	49.6	3 400	4 500	71.7	94	2.97	66.9	143.5	87.5	180	220	224.5	2	1	25 000	0.02~0.04	HAR934

- [Remarks] 1. Boundary dimensions of this bearing are the same as those of the 7900 series.
 2. For the dimensions of the spacers for oil / air lubrication, refer to Table 9. 4(2) on page 38.
 3. For the discharge intervals of the oil / air, refer to Supplementary table 6 on page 219.

Basic load ratings in case of multiple-row combination bearing

	Basic dynamic load ratings	Basic static load ratings
2-row	$C_r \times 1.62$	$C_{0r} \times 2$
3-row	$C_r \times 2.16$	$C_{0r} \times 3$
4-row	$C_r \times 2.64$	$C_{0r} \times 4$

Speed coefficients in case of multiple-row combination bearing

Combination types	Combination symbols	Preload when mounting			
		Preload S	Preload L	Preload M	Preload H
⊘ ⊘	DB	0.85	0.80	0.65	0.55
⊘ ⊘ ⊘ ⊘	DBB	0.80	0.75	0.60	0.45
⊘ ⊘ ⊘	DBD	0.75	0.70	0.55	0.40

*Speed coefficients also vary depending on the distance of bearings.

1. Angular contact ball bearings

High Ability

HAR00C series

Contact angle 15°

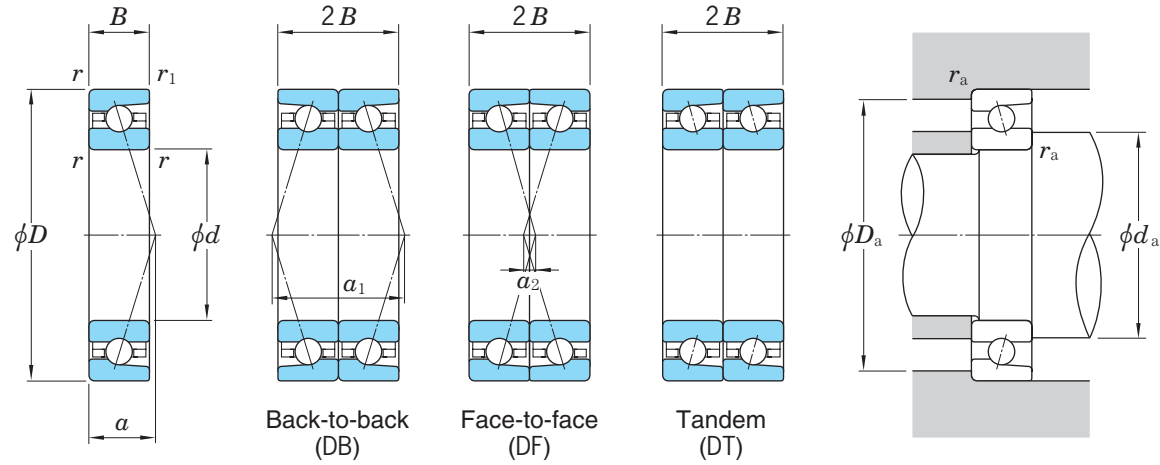

Static equivalent load $P_0 = X_0 F_r + Y_0 F_a$

Contact angle	Single row/Tandem		Back-to-back/Face-to-face	
	X_0	Y_0	X_0	Y_0
15°	0.5	0.46	1	0.92

Note that in the case of single row or tandem, assume $P_0 = F_r$ if $P_0 < F_r$.

Dynamic equivalent load $P = X F_r + Y F_a$

Contact angle	$i f_0 F_a / C_{0r}$	e	Single row/Tandem				Back-to-back/Face-to-face			
			$F_a / F_r \leq e$		$F_a / F_r > e$		$F_a / F_r \leq e$		$F_a / F_r > e$	
			X	Y	X	Y	X	Y	X	Y
15°	0.178	0.38			1.47	1.65			2.39	
	0.357	0.40			1.40	1.57			2.28	
	0.714	0.43			1.30	1.46			2.11	
	1.07	0.46			1.23	1.38			2.00	
	1.43	0.47	1	0	1.19	1.34	0.72	1.93		
	2.14	0.50			1.12	1.26			1.82	
	3.57	0.55			1.02	1.14			1.66	
	5.35	0.56			1.00	1.12			1.63	
	7.14	0.56			1.00	1.12			1.63	

1) For i , use 2 for DB & DF and 1 for single & DT.

Boundary dimensions (mm)					Bearing No.	Basic load ratings (kN)		Factor f_0	Limiting speeds (min ⁻¹)		Load center (mm) a	Interspace volume (cm ³ /row)	(Refer.) Mass (kg/row)	Permissible axial loads (kN) (static)	Load center spread of pair-mounted bearings (mm)		Mounting dimensions (mm)					Nut axial tension (N)	Interference of retaining plate (mm)	Bearing No.
d	D	B	$r_{min.}$	$r_{1 min.}$		C_r	C_{0r}		Grease lub.	Oil lub.					a_1	a_2	d_a min.	D_a max.	D_b max.	r_a max.	r_b max.			
30	55	13	1	0.6	HAR006C	8.70	4.85	7.9	26 000	40 000	12.2	4.4	0.116	6.14	24.4	1.6	35.5	49.5	50.5	1	0.6	5 000	0.01~0.02	HAR006C
35	62	14	1	0.6	HAR007C	9.25	5.55	8.1	23 000	35 000	13.5	5.5	0.158	7.02	27.0	1.0	40.5	56.5	57.5	1	0.6	8 000	0.01~0.02	HAR007C
40	68	15	1	0.6	HAR008C	9.70	6.20	8.2	20 000	31 000	14.7	6.6	0.200	7.88	29.5	0.5	45.5	62.5	63.5	1	0.6	8 000	0.01~0.02	HAR008C
45	75	16	1	0.6	HAR009C	10.9	7.10	8.3	18 000	28 000	16.0	8.4	0.251	9.03	32.1	0.1	50.5	69.5	70.5	1	0.6	10 000	0.01~0.02	HAR009C
50	80	16	1	0.6	HAR010C	11.4	7.85	8.4	17 000	26 000	16.7	10	0.273	9.98	33.4	1.4	55.5	74.5	75.5	1	0.6	10 000	0.01~0.02	HAR010C
55	90	18	1.1	0.6	HAR011C	14.1	9.90	8.4	15 000	23 000	18.7	13	0.403	12.6	37.4	1.4	62	83	85.5	1	0.6	12 000	0.01~0.02	HAR011C
60	95	18	1.1	0.6	HAR012C	14.7	10.8	8.5	14 000	22 000	19.4	15	0.433	13.8	38.8	2.8	67	88	90.5	1	0.6	12 000	0.01~0.02	HAR012C
65	100	18	1.1	0.6	HAR013C	15.3	11.8	8.5	13 000	21 000	20.1	16	0.462	14.9	40.1	4.1	72	93	95.5	1	0.6	15 000	0.01~0.02	HAR013C
70	110	20	1.1	0.6	HAR014C	20.7	15.5	8.4	12 000	19 000	22.1	23	0.629	19.7	44.1	4.1	77	103	105.5	1	0.6	15 000	0.01~0.02	HAR014C
75	115	20	1.1	0.6	HAR015C	21.1	16.2	8.5	12 000	18 000	22.7	25	0.665	20.6	45.5	5.5	82	108	110.5	1	0.6	15 000	0.01~0.02	HAR015C
80	125	22	1.1	0.6	HAR016C	24.7	19.2	8.4	10 000	16 000	24.7	31	0.903	24.5	49.5	5.5	87	118	120.5	1	0.6	15 000	0.01~0.02	HAR016C
85	130	22	1.1	0.6	HAR017C	25.1	20.1	8.5	9 700	15 000	25.4	33	0.947	25.6	50.8	6.8	92	123	125.5	1	0.6	18 000	0.01~0.02	HAR017C
90	140	24	1.5	1	HAR018C	32.8	26.1	8.4	9 100	14 000	27.4	43	1.21	33.1	54.8	6.8	98.5	131.5	134.5	1.5	1	18 000	0.01~0.02	HAR018C
95	145	24	1.5	1	HAR019C	33.4	27.2	8.5	8 700	13 000	28.1	45	1.28	34.6	56.2	8.2	103.5	136.5	139.5	1.5	1	18 000	0.01~0.02	HAR019C
100	150	24	1.5	1	HAR020C	34.0	28.4	8.5	8 400	13 000	28.7	47	1.32	36.1	57.5	9.5	108.5	141.5	144.5	1.5	1	20 000	0.01~0.02	HAR020C
105	160	26	2	1	HAR021C	38.6	32.5	8.5	7 900	12 000	30.8	57	1.68	41.4	61.5	9.5	115	150	154.5	2	1	20 000	0.02~0.04	HAR021C
110	170	28	2	1	HAR022C	43.4	37.0	8.5	7 500	12 000	32.8	68	2.11	47.1	65.5	9.5	120	160	164.5	2	1	20 000	0.02~0.04	HAR022C
120	180	28	2	1	HAR024C	44.9	39.9	8.5	7 000	11 000	34.1	73	2.26	50.9	68.2	12.2	130	170	174.5	2	1	20 000	0.02~0.04	HAR024C
130	200	33	2	1	HAR026C	56.3	48.4	8.5	6 300	9 800	38.6	115	3.38	61.6	77.2	11.2	140	190	194.5	2	1	20 000	0.02~0.04	HAR026C
140	210	33	2	1	HAR028C	61.3	56.2	8.5	6 000	9 200	39.9	120	3.62	71.6	79.9	13.9	150	200	204.5	2	1	25 000	0.02~0.04	HAR028C
150	225	35	2	1	HAR030C	72.2	66.1	8.5	5 300	8 200	42.6	150	4.36	84.2	85.2	15.2	160	215	219.5	2	1	25 000	0.02~0.04	HAR030C
160	240	38	2.1	1.1	HAR032C	78.3	72.7	8.5	5 000	7 700	45.8	186	5.40	92.7	91.6	15.6	172	228	233	2	1	30 000	0.02~0.04	HAR032C
170	260	42	2.1	1.1	HAR034C	91.8	86.4	8.5	4 600	7 100	49.8	236	7.32	110	99.6	15.6	182	248	253	2	1	30 000	0.02~0.04	HAR034C

- [Remarks]
- Boundary dimensions of this bearing are the same as those of the 7000 series.
 - For the dimensions of the spacers for oil / air lubrication, refer to Table 9. 4(2) on page 38.
 - For the discharge intervals of the oil / air, refer to Supplementary table 6 on page 219.

Basic load ratings in case of multiple-row combination bearing

	Basic dynamic load ratings	Basic static load ratings
2-row	$C_r \times 1.62$	$C_{0r} \times 2$
3-row	$C_r \times 2.16$	$C_{0r} \times 3$
4-row	$C_r \times 2.64$	$C_{0r} \times 4$

Speed coefficients in case of multiple-row combination bearing

Combination types	Combination symbols	Preload when mounting			
		Preload S	Preload L	Preload M	Preload H
⊗ ⊗	DB	0.85	0.80	0.65	0.55
⊗ ⊗ ⊗ ⊗	DBB	0.80	0.75	0.60	0.45
⊗ ⊗ ⊗	DBD	0.75	0.70	0.55	0.40

*Speed coefficients also vary depending on the distance of bearings.

1. Angular contact ball bearings

High Ability

HAR00CA series

Contact angle 20°

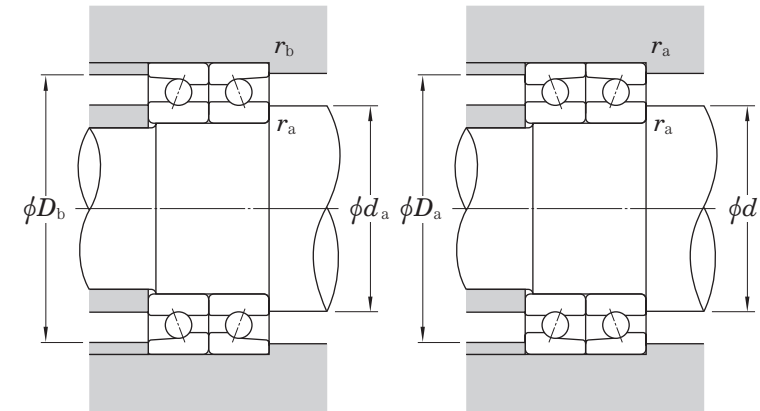
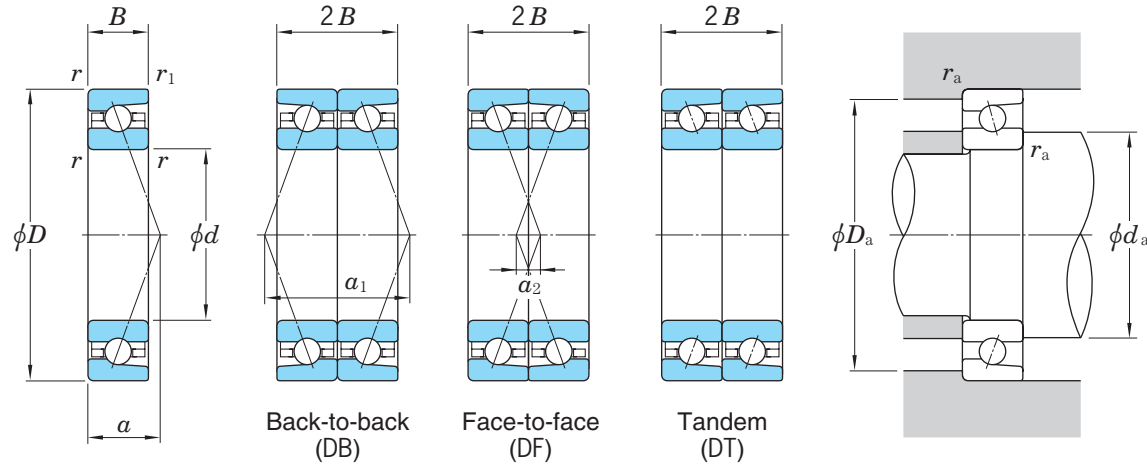

Static equivalent load $P_0 = X_0 F_r + Y_0 F_a$

Contact angle	Single row/Tandem		Back-to-back/Face-to-face	
	X_0	Y_0	X_0	Y_0
20°	0.5	0.42	1	0.84

Note that in the case of single row or tandem, assume $P_0 = F_r$ if $P_0 > F_r$.

Dynamic equivalent load $P = X F_r + Y F_a$

Contact angle	e	Single row/Tandem		Back-to-back/Face-to-face					
		$\frac{F_a}{F_r} \leq e$	$\frac{F_a}{F_r} > e$	$\frac{F_a}{F_r} \leq e$	$\frac{F_a}{F_r} > e$	X	Y		
20°	0.57	1	0	0.43	1	1	1.09	0.70	1.63

d	Boundary dimensions (mm)				Bearing No.	Basic load ratings (kN)		Limiting speeds (min ⁻¹)		Load center (mm) a	Interspace volume (cm ³ /row)	(Refer.) Mass (kg/row)	Permissible axial loads (kN) (static)	Load center spread of pair-mounted bearings (mm)		Mounting dimensions (mm)					Nut axial tension (N)	Interference of retaining plate (mm)	Bearing No.
	D	B	r min.	r ₁ min.		C _r	C _{0r}	Grease lub.	Oil lub.					a ₁	a ₂	d _a min.	D _a max.	D _b max.	r _a max.	r _b max.			
30	55	13	1	0.6	HAR006CA	8.55	4.75	25 000	38 000	14.2	4.4	0.116	7.25	28.5	2.5	35.5	49.5	50.5	1	0.6	5 000	0.01~0.02	HAR006CA
35	62	14	1	0.6	HAR007CA	9.05	5.40	22 000	33 000	15.8	5.5	0.158	7.44	31.7	3.7	40.5	56.5	57.5	1	0.6	8 000	0.01~0.02	HAR007CA
40	68	15	1	0.6	HAR008CA	9.50	6.05	19 000	30 000	17.3	6.6	0.200	9.27	34.7	4.7	45.5	62.5	63.5	1	0.6	8 000	0.01~0.02	HAR008CA
45	75	16	1	0.6	HAR009CA	10.6	6.95	18 000	27 000	18.9	8.4	0.251	10.6	37.8	5.8	50.5	69.5	70.5	1	0.6	10 000	0.01~0.02	HAR009CA
50	80	16	1	0.6	HAR010CA	11.1	7.65	16 000	25 000	19.8	10	0.273	11.7	39.7	7.7	55.5	74.5	75.5	1	0.6	10 000	0.01~0.02	HAR010CA
55	90	18	1.1	0.6	HAR011CA	13.7	9.70	14 000	22 000	22.2	13	0.403	14.8	44.4	8.4	62	83	85.5	1	0.6	12 000	0.01~0.02	HAR011CA
60	95	18	1.1	0.6	HAR012CA	14.3	10.6	14 000	21 000	23.1	15	0.433	16.1	46.2	10.2	67	88	90.5	1	0.6	12 000	0.01~0.02	HAR012CA
65	100	18	1.1	0.6	HAR013CA	14.9	11.5	13 000	19 000	24.0	16	0.462	17.5	48.0	12.0	72	93	95.5	1	0.6	15 000	0.01~0.02	HAR013CA
70	110	20	1.1	0.6	HAR014CA	20.2	15.1	12 000	18 000	26.4	23	0.629	23.1	52.8	12.8	77	103	105.5	1	0.6	15 000	0.01~0.02	HAR014CA
75	115	20	1.1	0.6	HAR015CA	20.6	15.8	11 000	17 000	27.3	25	0.665	24.2	54.6	14.6	82	108	110.5	1	0.6	15 000	0.01~0.02	HAR015CA
80	125	22	1.1	0.6	HAR016CA	24.1	18.8	9 700	15 000	29.7	31	0.903	28.7	59.3	15.3	87	118	120.5	1	0.6	15 000	0.01~0.02	HAR016CA
85	130	22	1.1	0.6	HAR017CA	24.5	19.6	9 300	14 000	30.6	33	0.947	30.0	61.1	17.1	92	123	125.5	1	0.6	18 000	0.01~0.02	HAR017CA
90	140	24	1.5	1	HAR018CA	32.0	25.4	8 700	13 000	32.9	43	1.21	38.9	65.9	17.9	98.5	131.5	134.5	1.5	1	18 000	0.01~0.02	HAR018CA
95	145	24	1.5	1	HAR019CA	32.6	26.6	8 300	13 000	33.8	45	1.28	40.6	67.7	19.7	103.5	136.5	139.5	1.5	1	18 000	0.01~0.02	HAR019CA
100	150	24	1.5	1	HAR020CA	33.2	27.7	8 000	12 000	34.7	47	1.32	42.4	69.5	21.5	108.5	141.5	144.5	1.5	1	20 000	0.01~0.02	HAR020CA
105	160	26	2	1	HAR021CA	37.6	31.7	7 500	11 000	37.1	57	1.68	48.6	74.2	22.2	115	150	154.5	2	1	20 000	0.02~0.04	HAR021CA
110	170	28	2	1	HAR022CA	42.4	36.1	7 100	11 000	39.5	68	2.11	55.2	79.0	23.0	120	160	164.5	2	1	20 000	0.02~0.04	HAR022CA
120	180	28	2	1	HAR024CA	43.8	39.0	6 700	10 000	41.3	73	2.26	59.7	82.6	26.6	130	170	174.5	2	1	20 000	0.02~0.04	HAR024CA
130	200	33	2	1	HAR026CA	55.0	47.2	6 000	9 200	46.5	115	3.38	72.2	93.1	27.1	140	190	194.5	2	1	20 000	0.02~0.04	HAR026CA
140	210	33	2	1	HAR028CA	59.9	54.8	5 700	8 700	48.3	120	3.62	84.0	96.7	30.7	150	200	204.5	2	1	25 000	0.02~0.04	HAR028CA
150	225	35	2	1	HAR030CA	70.5	64.5	5 000	7 700	51.6	150	4.36	98.8	103.2	33.2	160	215	219.5	2	1	25 000	0.02~0.04	HAR030CA
160	240	38	2.1	1.1	HAR032CA	76.4	71.0	4 700	7 200	55.4	186	5.40	108	110.8	34.8	172	228	233	2	1	30 000	0.02~0.04	HAR032CA
170	260	42	2.1	1.1	HAR034CA	89.6	84.3	4 400	6 700	60.1	236	7.32	129	120.3	36.3	182	248	253	2	1	30 000	0.02~0.04	HAR034CA

- [Remarks]
- Boundary dimensions of this bearing are the same as those of the 7000 series.
 - For the dimensions of the spacers for oil / air lubrication, refer to Table 9. 4(2) on page 38.
 - For the discharge intervals of the oil / air, refer to Supplementary table 6 on page 219.

Basic load ratings in case of multiple-row combination bearing

	Basic dynamic load ratings	Basic static load ratings
2-row	$C_r \times 1.62$	$C_{0r} \times 2$
3-row	$C_r \times 2.16$	$C_{0r} \times 3$
4-row	$C_r \times 2.64$	$C_{0r} \times 4$

Speed coefficients in case of multiple-row combination bearing

Combination types	Combination symbols	Preload when mounting			
		Preload S	Preload L	Preload M	Preload H
⊗ ⊗	DB	0.85	0.80	0.65	0.55
⊗ ⊗ ⊗ ⊗	DBB	0.80	0.75	0.60	0.45
⊗ ⊗ ⊗	DBD	0.75	0.70	0.55	0.40

*Speed coefficients also vary depending on the distance of bearings.

1. Angular contact ball bearings

High Ability

HAR000 series

Contact angle 30°

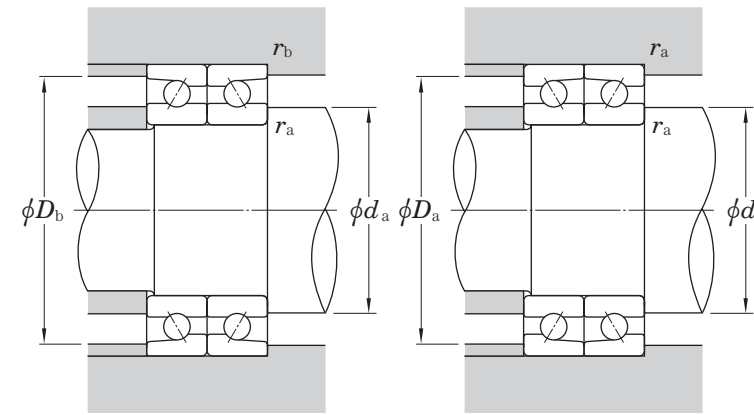
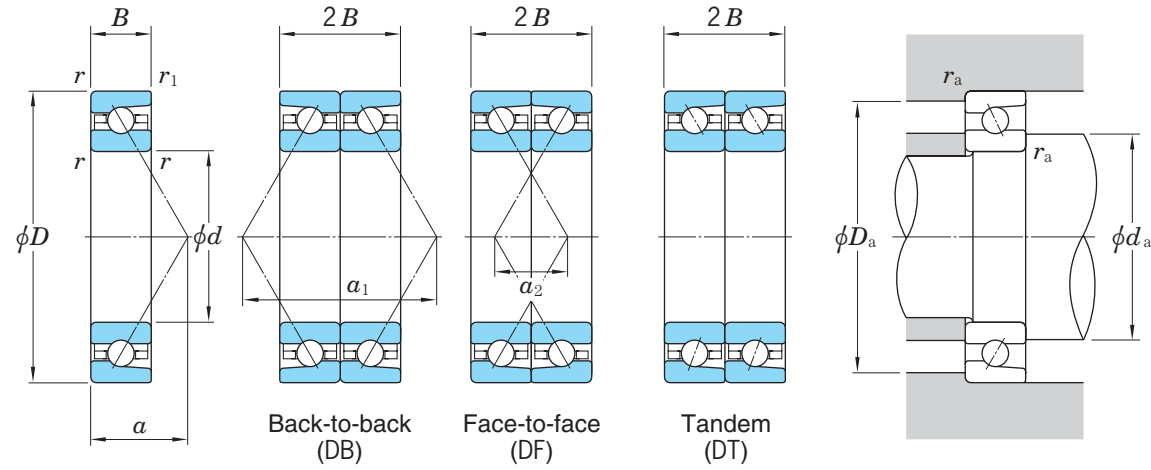

Static equivalent load $P_0 = X_0 F_r + Y_0 F_a$

Contact angle	Single row/Tandem		Back-to-back/Face-to-face	
	X_0	Y_0	X_0	Y_0
30°	0.5	0.33	1	0.66

Note that in the case of single row or tandem, assume $P_0 = F_r$ if $P_0 < F_r$.

Dynamic equivalent load $P = X F_r + Y F_a$

Contact angle	e	Single row/Tandem				Back-to-back/Face-to-face			
		$\frac{F_a}{F_r} \leq e$		$\frac{F_a}{F_r} > e$		$\frac{F_a}{F_r} \leq e$		$\frac{F_a}{F_r} > e$	
		X	Y	X	Y	X	Y	X	Y
30°	0.80	1	0	0.39	0.76	1	0.78	0.63	1.24

d	Boundary dimensions (mm)				Bearing No.	Basic load ratings (kN)		Limiting speeds (min ⁻¹)		Load center (mm) a	Interspace volume (cm ³ /row)	(Refer.) Mass (kg/row)	Permissible axial loads (kN) (static)	Load center spread of pair-mounted bearings (mm)		Mounting dimensions (mm)					Nut axial tension (N)	Interference of retaining plate (mm)	Bearing No.
	D	B	r min.	r ₁ min.		C _r	C _{0r}	Grease lub.	Oil lub.					a ₁	a ₂	d _a min.	D _a max.	D _b max.	r _a max.	r _b max.			
30	55	13	1	0.6	HAR006	8.00	4.45	18 000	24 000	18.8	4.4	0.116	6.37	37.5	11.5	35.5	49.5	50.5	1	0.6	5 000	0.01~0.02	HAR006
35	62	14	1	0.6	HAR007	8.45	5.05	15 000	21 000	21.0	5.5	0.158	6.58	42.0	14.0	40.5	56.5	57.5	1	0.6	8 000	0.01~0.02	HAR007
40	68	15	1	0.6	HAR008	8.85	5.65	14 000	19 000	23.1	6.6	0.200	7.75	46.2	16.2	45.5	62.5	63.5	1	0.6	8 000	0.01~0.02	HAR008
45	75	16	1	0.6	HAR009	9.90	6.45	13 000	17 000	25.3	8.4	0.251	9.56	50.6	18.6	50.5	69.5	70.5	1	0.6	10 000	0.01~0.02	HAR009
50	80	16	1	0.6	HAR010	10.4	7.15	12 000	15 000	26.8	10	0.273	10.4	53.5	21.5	55.5	74.5	75.5	1	0.6	10 000	0.01~0.02	HAR010
55	90	18	1.1	0.6	HAR011	12.8	9.00	10 000	14 000	29.9	13	0.403	12.8	59.9	23.9	62	83	85.5	1	0.6	12 000	0.01~0.02	HAR011
60	95	18	1.1	0.6	HAR012	13.4	9.85	9 700	13 000	31.4	15	0.433	13.9	62.7	26.7	67	88	90.5	1	0.6	12 000	0.01~0.02	HAR012
65	100	18	1.1	0.6	HAR013	13.9	10.7	9 100	12 000	32.8	16	0.462	14.9	65.6	29.6	72	93	95.5	1	0.6	15 000	0.01~0.02	HAR013
70	110	20	1.1	0.6	HAR014	18.9	14.1	8 300	11 000	36.0	23	0.629	20.3	72.0	32.0	77	103	105.5	1	0.6	15 000	0.01~0.02	HAR014
75	115	20	1.1	0.6	HAR015	19.2	14.7	7 900	11 000	37.4	25	0.665	21.0	74.8	34.8	82	108	110.5	1	0.6	15 000	0.01~0.02	HAR015
80	125	22	1.1	0.6	HAR016	22.5	17.5	7 000	9 300	40.6	31	0.903	24.6	81.2	37.2	87	118	120.5	1	0.6	15 000	0.01~0.02	HAR016
85	130	22	1.1	0.6	HAR017	22.8	18.3	6 600	8 800	42.0	33	0.947	26.3	84.1	40.1	92	123	125.5	1	0.6	18 000	0.01~0.02	HAR017
90	140	24	1.5	1	HAR018	29.8	23.7	6 200	8 300	45.2	43	1.21	33.4	90.4	42.4	98.5	131.5	134.5	1.5	1	18 000	0.01~0.02	HAR018
95	145	24	1.5	1	HAR019	30.4	24.7	5 900	7 900	46.6	45	1.28	33.5	93.3	45.3	103.5	136.5	139.5	1.5	1	18 000	0.01~0.02	HAR019
100	150	24	1.5	1	HAR020	30.9	25.8	5 700	7 600	48.1	47	1.32	37.4	96.2	48.2	108.5	141.5	144.5	1.5	1	20 000	0.01~0.02	HAR020
105	160	26	2	1	HAR021	35.0	29.5	5 400	7 200	51.2	57	1.68	42.0	102.5	50.5	115	150	154.5	2	1	20 000	0.02~0.04	HAR021
110	170	28	2	1	HAR022	39.4	33.6	5 100	6 800	54.4	68	2.11	47.0	108.8	52.8	120	160	164.5	2	1	20 000	0.02~0.04	HAR022
120	180	28	2	1	HAR024	40.7	36.2	4 800	6 300	57.3	73	2.26	50.3	114.6	58.6	130	170	174.5	2	1	20 000	0.02~0.04	HAR024
130	200	33	2	1	HAR026	51.2	43.9	4 300	5 800	64.1	115	3.38	62.3	128.3	62.3	140	190	194.5	2	1	20 000	0.02~0.04	HAR026
140	210	33	2	1	HAR028	55.7	51.0	4 100	5 400	67.0	120	3.62	71.9	134.0	68.0	150	200	204.5	2	1	25 000	0.02~0.04	HAR028
150	225	35	2	1	HAR030	65.6	60.0	3 600	4 800	71.6	150	4.36	82.9	143.3	73.3	160	215	219.5	2	1	25 000	0.02~0.04	HAR030
160	240	38	2.1	1.1	HAR032	71.1	66.0	3 400	4 500	76.7	186	5.40	90.0	153.5	77.5	172	228	233	2	1	30 000	0.02~0.04	HAR032
170	260	42	2.1	1.1	HAR034	83.4	78.4	3 100	4 200	83.1	236	7.32	109	166.1	82.1	182	248	253	2	1	30 000	0.02~0.04	HAR034

- [Remarks]
- Boundary dimensions of this bearing are the same as those of the 7000 series.
 - For the dimensions of the spacers for oil / air lubrication, refer to Table 9. 4(2) on page 38.
 - For the discharge intervals of the oil / air, refer to Supplementary table 6 on page 219.

Basic load ratings in case of multiple-row combination bearing

	Basic dynamic load ratings	Basic static load ratings
2-row	$C_r \times 1.62$	$C_{0r} \times 2$
3-row	$C_r \times 2.16$	$C_{0r} \times 3$
4-row	$C_r \times 2.64$	$C_{0r} \times 4$

Speed coefficients in case of multiple-row combination bearing

Combination types	Combination symbols	Preload when mounting			
		Preload S	Preload L	Preload M	Preload H
⊗ ⊗	DB	0.85	0.80	0.65	0.55
⊗ ⊗ ⊗ ⊗	DBB	0.80	0.75	0.60	0.45
⊗ ⊗ ⊗	DBD	0.75	0.70	0.55	0.40

*Speed coefficients also vary depending on the distance of bearings.

1. Angular contact ball bearings

High Ability Ceramic bearings

3NCHAR900C series

Contact angle 15°

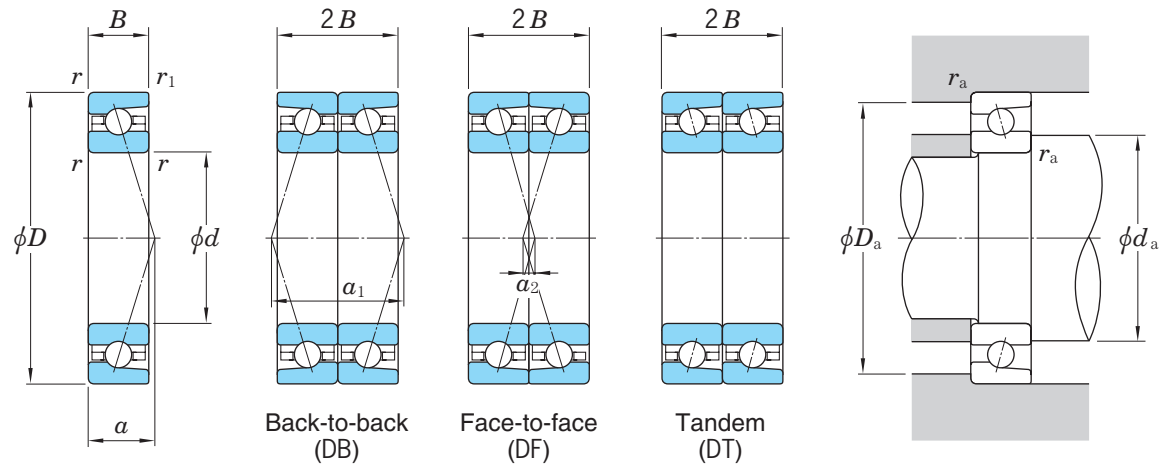

Static equivalent load $P_0 = X_0 F_r + Y_0 F_a$

Contact angle	Single row/Tandem		Back-to-back/Face-to-face	
	X_0	Y_0	X_0	Y_0
15°	0.5	0.46	1	0.92

Note that in the case of single row or tandem, assume $P_0 = F_r$ if $P_0 < F_r$.

Dynamic equivalent load $P = X F_r + Y F_a$

Contact angle	$i_0 F_a / C_{0r}$	e	Single row/Tandem				Back-to-back/Face-to-face			
			$F_a / F_r \leq e$		$F_a / F_r > e$		$F_a / F_r \leq e$		$F_a / F_r > e$	
			X	Y	X	Y	X	Y	X	Y
15°	0.178	0.38			1.47	1.65			2.39	
	0.357	0.40			1.40	1.57			2.28	
	0.714	0.43			1.30	1.46			2.11	
	1.07	0.46			1.23	1.38			2.00	
	1.43	0.47	1	0	0.44	1.19	1	0.72	1.93	
	2.14	0.50			1.12	1.26			1.82	
	3.57	0.55			1.02	1.14			1.66	
	5.35	0.56			1.00	1.12			1.63	
7.14	0.56			1.00	1.12			1.63		

1) For i , use 2 for DB & DF and 1 for single & DT.

Boundary dimensions (mm)					Bearing No.	Basic load ratings (kN)		Factor f_0	Limiting speeds (min^{-1})		Load center (mm) a	Interspace volume (cm^3/row)	(Refer.) Mass (kg/row)	Permissible axial loads (kN) (static)	Load center spread of pair-mounted bearings (mm)		Mounting dimensions (mm)					Nut axial tension (N)	Interference of retaining plate (mm)	Bearing No.
d	D	B	r_{min}	$r_{1\text{min}}$		C_r	C_{0r}		Grease lub.	Oil lub.					a_1	a_2	d_a min.	D_a max.	D_b max.	r_a max.	r_b max.			
40	62	12	0.6	0.3	3NCHAR908C	6.35	4.05	8.4	29 000	49 000	12.8	4.1	0.109	3.30	25.7	1.7	44.5	57.5	59.5	0.6	0.3	5 000	0.01~0.02	3NCHAR908C
45	68	12	0.6	0.3	3NCHAR909C	6.80	4.70	8.5	27 000	44 000	13.6	4.6	0.129	3.80	27.1	3.1	49.5	63.5	65.5	0.6	0.3	6 000	0.01~0.02	3NCHAR909C
50	72	12	0.6	0.3	3NCHAR910C	9.10	6.30	8.5	25 000	41 000	14.2	5.6	0.122	5.13	28.3	4.3	54.5	67.5	69.5	0.6	0.3	6 000	0.01~0.02	3NCHAR910C
55	80	13	1	0.6	3NCHAR911C	10.1	7.65	8.6	22 000	37 000	15.5	6.5	0.176	6.24	31.1	5.1	60.5	74.5	75.5	1	0.6	6 000	0.01~0.02	3NCHAR911C
60	85	13	1	0.6	3NCHAR912C	10.0	7.75	8.6	21 000	34 000	16.2	7.0	0.189	6.30	32.4	6.4	65.5	79.5	80.5	1	0.6	8 000	0.01~0.02	3NCHAR912C
65	90	13	1	0.6	3NCHAR913C	11.8	9.45	8.6	19 000	32 000	16.9	7.9	0.196	7.70	33.8	7.8	70.5	84.5	85.5	1	0.6	8 000	0.01~0.02	3NCHAR913C
70	100	16	1	0.6	3NCHAR914C	12.9	10.5	8.7	18 000	29 000	19.4	12	0.337	8.52	38.8	6.8	75.5	94.5	95.5	1	0.6	10 000	0.01~0.02	3NCHAR914C
75	105	16	1	0.6	3NCHAR915C	13.3	11.2	8.7	17 000	28 000	20.1	12	0.349	9.12	40.1	8.1	80.5	99.5	100.5	1	0.6	10 000	0.01~0.02	3NCHAR915C
80	110	16	1	0.6	3NCHAR916C	13.6	11.9	8.8	16 000	26 000	20.7	13	0.376	9.73	41.5	9.5	85.5	104.5	105.5	1	0.6	10 000	0.01~0.02	3NCHAR916C
85	120	18	1.1	0.6	3NCHAR917C	16.3	14.2	8.7	14 000	23 000	22.7	18	0.541	11.5	45.5	9.5	92	113	115.5	1	0.6	12 000	0.01~0.02	3NCHAR917C
90	125	18	1.1	0.6	3NCHAR918C	16.8	15.1	8.8	13 000	22 000	23.4	19	0.567	12.3	46.8	10.8	97	118	120.5	1	0.6	12 000	0.01~0.02	3NCHAR918C
95	130	18	1.1	0.6	3NCHAR919C	17.3	16.0	8.8	13 000	21 000	24.1	19	0.593	13.0	48.1	12.1	102	123	125.5	1	0.6	12 000	0.01~0.02	3NCHAR919C
100	140	20	1.1	0.6	3NCHAR920C	24.2	21.7	8.7	12 000	20 000	26.1	28	0.784	17.7	52.2	12.2	107	133	135.5	1	0.6	15 000	0.01~0.02	3NCHAR920C
105	145	20	1.1	0.6	3NCHAR921C	24.9	23.1	8.7	11 000	19 000	26.7	29	0.816	18.8	53.5	13.5	112	138	140.5	1	0.6	15 000	0.02~0.04	3NCHAR921C
110	150	20	1.1	0.6	3NCHAR922C	25.1	23.8	8.7	11 000	18 000	27.4	30	0.849	19.4	54.8	14.8	117	143	145.5	1	0.6	15 000	0.02~0.04	3NCHAR922C
120	165	22	1.1	0.6	3NCHAR924C	29.4	28.4	8.8	10 000	17 000	30.1	40	1.17	23.1	60.2	16.2	127	158	160.5	1	0.6	15 000	0.02~0.04	3NCHAR924C
130	180	24	1.5	1	3NCHAR926C	35.1	35.1	8.8	9 200	15 000	32.8	51	1.56	28.6	65.5	17.5	138.5	171.5	174.5	1.5	1	20 000	0.02~0.04	3NCHAR926C
140	190	24	1.5	1	3NCHAR928C	35.2	36.2	8.8	8 600	14 000	34.1	57	1.65	29.5	68.2	20.2	148.5	181.5	184.5	1.5	1	20 000	0.02~0.04	3NCHAR928C
150	210	28	2	1	3NCHAR930C	48.9	48.9	8.7	7 900	13 000	38.1	85	2.50	39.8	76.2	20.2	160	200	204.5	2	1	20 000	0.02~0.04	3NCHAR930C
160	220	28	2	1	3NCHAR932C	50.2	51.8	8.8	7 100	12 000	39.5	90	2.64	42.2	78.9	22.9	170	210	214.5	2	1	25 000	0.02~0.04	3NCHAR932C
170	230	28	2	1	3NCHAR934C	51.4	54.8	8.8	6 800	11 000	40.8	94	2.77	44.7	81.6	25.6	180	220	224.5	2	1	25 000	0.02~0.04	3NCHAR934C

- [Remarks]
- Boundary dimensions of this bearing are the same as those of the 7900 series.
 - For the dimensions of the spacers for oil / air lubrication, refer to Table 9. 4(2) on page 38.
 - For the discharge intervals of the oil / air, refer to Supplementary table 6 on page 219.

Basic load ratings in case of multiple-row combination bearing

	Basic dynamic load ratings	Basic static load ratings
2-row	$C_r \times 1.62$	$C_{0r} \times 2$
3-row	$C_r \times 2.16$	$C_{0r} \times 3$
4-row	$C_r \times 2.64$	$C_{0r} \times 4$

Speed coefficients in case of multiple-row combination bearing

Combination types	Combination symbols	Preload when mounting			
		Preload S	Preload L	Preload M	Preload H
\emptyset \emptyset	DB	0.85	0.80	0.65	0.55
\emptyset/\emptyset \emptyset/\emptyset	DBB	0.80	0.75	0.60	0.45
\emptyset/\emptyset \emptyset	DBD	0.75	0.70	0.55	0.40

*Speed coefficients also vary depending on the distance of bearings.

1. Angular contact ball bearings

High Ability Ceramic bearings

3NCHAR900CA series

Contact angle 20°

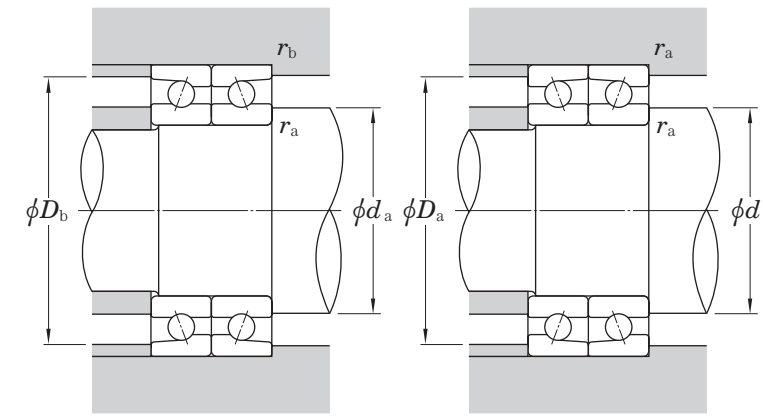
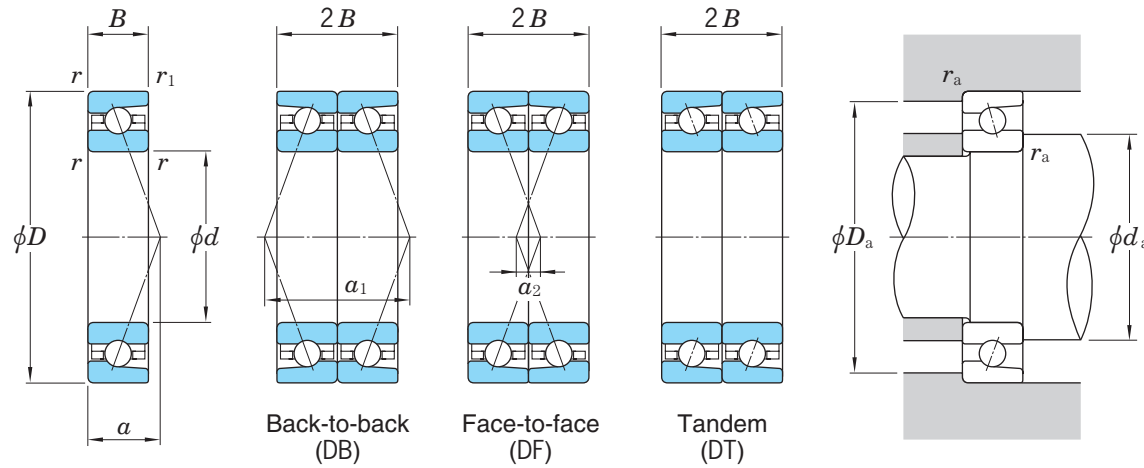

Static equivalent load $P_0 = X_0 F_r + Y_0 F_a$
 Note that in the case of single row or tandem, assume $P_0 = F_r$ if $P_0 > F_r$.

Contact angle	Single row/Tandem		Back-to-back/Face-to-face	
	X_0	Y_0	X_0	Y_0
20°	0.5	0.42	1	0.84

Dynamic equivalent load $P = X F_r + Y F_a$

Contact angle	e	Single row/Tandem				Back-to-back/Face-to-face			
		$\frac{F_a}{F_r} \leq e$		$\frac{F_a}{F_r} > e$		$\frac{F_a}{F_r} \leq e$		$\frac{F_a}{F_r} > e$	
		X	Y	X	Y	X	Y	X	Y
20°	0.57	1	0	0.43	1	1	1.09	0.70	1.63

d	Boundary dimensions (mm)				Bearing No.	Basic load ratings (kN)		Limiting speeds (min ⁻¹)		Load center (mm) a	Interspace volume (cm ³ /row)	(Refer.) Mass (kg/row)	Permissible axial loads (kN) (static)	Load center spread of pair-mounted bearings (mm)		Mounting dimensions (mm)					Nut axial tension (N)	Interference of retaining plate (mm)	Bearing No.
	D	B	r min.	r ₁ min.		C _r	C _{0r}	Grease lub.	Oil lub.					a ₁	a ₂	d _a min.	D _a max.	D _b max.	r _a max.	r _b max.			
40	62	12	0.6	0.3	3NCHAR908CA	6.20	3.95	27 000	46 000	15.3	4.1	0.109	4.00	30.6	6.6	44.5	57.5	59.5	0.6	0.3	5 000	0.01~0.02	3NCHAR908CA
45	68	12	0.6	0.3	3NCHAR909CA	6.65	4.55	25 000	42 000	16.3	4.6	0.129	4.61	32.6	8.6	49.5	63.5	65.5	0.6	0.3	6 000	0.01~0.02	3NCHAR909CA
50	72	12	0.6	0.3	3NCHAR910CA	8.90	6.15	23 000	39 000	17.1	5.6	0.122	6.22	34.2	10.2	54.5	67.5	69.5	0.6	0.3	6 000	0.01~0.02	3NCHAR910CA
55	80	13	1	0.6	3NCHAR911CA	9.85	7.50	21 000	35 000	18.8	6.5	0.176	7.06	37.6	11.6	60.5	74.5	75.5	1	0.6	6 000	0.01~0.02	3NCHAR911CA
60	85	13	1	0.6	3NCHAR912CA	9.70	7.55	19 000	32 000	19.7	7.0	0.189	7.62	39.4	13.4	65.5	79.5	80.5	1	0.6	8 000	0.01~0.02	3NCHAR912CA
65	90	13	1	0.6	3NCHAR913CA	11.5	9.25	18 000	30 000	20.6	7.9	0.196	9.32	41.2	15.2	70.5	84.5	85.5	1	0.6	8 000	0.01~0.02	3NCHAR913CA
70	100	16	1	0.6	3NCHAR914CA	12.6	10.2	16 000	28 000	23.5	12	0.337	10.3	46.9	14.9	75.5	94.5	95.5	1	0.6	10 000	0.01~0.02	3NCHAR914CA
75	105	16	1	0.6	3NCHAR915CA	12.9	10.9	16 000	26 000	24.4	12	0.349	11.0	48.8	16.8	80.5	99.5	100.5	1	0.6	10 000	0.01~0.02	3NCHAR915CA
80	110	16	1	0.6	3NCHAR916CA	13.3	11.6	15 000	25 000	25.3	13	0.376	11.7	50.6	18.6	85.5	104.5	105.5	1	0.6	10 000	0.01~0.02	3NCHAR916CA
85	120	18	1.1	0.6	3NCHAR917CA	15.9	13.8	13 000	22 000	27.7	18	0.541	13.9	55.3	19.3	92	113	115.5	1	0.6	12 000	0.01~0.02	3NCHAR917CA
90	125	18	1.1	0.6	3NCHAR918CA	16.4	14.7	12 000	21 000	28.6	19	0.567	14.8	57.1	21.1	97	118	120.5	1	0.6	12 000	0.01~0.02	3NCHAR918CA
95	130	18	1.1	0.6	3NCHAR919CA	16.9	15.6	12 000	20 000	29.5	19	0.593	15.8	58.9	22.9	102	123	125.5	1	0.6	12 000	0.01~0.02	3NCHAR919CA
100	140	20	1.1	0.6	3NCHAR920CA	23.6	21.2	11 000	19 000	31.8	28	0.784	21.4	63.7	23.7	107	133	135.5	1	0.6	15 000	0.01~0.02	3NCHAR920CA
105	145	20	1.1	0.6	3NCHAR921CA	24.3	22.5	11 000	18 000	32.7	29	0.816	22.8	65.5	25.5	112	138	140.5	1	0.6	15 000	0.02~0.04	3NCHAR921CA
110	150	20	1.1	0.6	3NCHAR922CA	24.5	23.2	10 000	17 000	33.7	30	0.849	23.5	67.3	27.3	117	143	145.5	1	0.6	15 000	0.02~0.04	3NCHAR922CA
120	165	22	1.1	0.6	3NCHAR924CA	28.6	27.7	9 300	16 000	36.9	40	1.17	28.0	73.9	29.9	127	158	160.5	1	0.6	15 000	0.02~0.04	3NCHAR924CA
130	180	24	1.5	1	3NCHAR926CA	34.2	34.3	8 600	14 000	40.2	51	1.56	34.6	80.4	32.4	138.5	171.5	174.5	1.5	1	20 000	0.02~0.04	3NCHAR926CA
140	190	24	1.5	1	3NCHAR928CA	34.3	35.3	8 100	14 000	42.0	57	1.65	35.7	84.1	36.1	148.5	181.5	184.5	1.5	1	20 000	0.02~0.04	3NCHAR928CA
150	210	28	2	1	3NCHAR930CA	47.7	47.6	7 400	12 000	46.8	85	2.50	48.1	93.5	37.5	160	200	204.5	2	1	20 000	0.02~0.04	3NCHAR930CA
160	220	28	2	1	3NCHAR932CA	48.9	50.5	6 600	11 000	48.6	90	2.64	51.1	97.2	41.2	170	210	214.5	2	1	25 000	0.02~0.04	3NCHAR932CA
170	230	28	2	1	3NCHAR934CA	50.1	53.4	6 300	11 000	50.4	94	2.77	54.0	100.8	44.8	180	220	224.5	2	1	25 000	0.02~0.04	3NCHAR934CA

- [Remarks] 1. Boundary dimensions of this bearing are the same as those of the 7900 series.
 2. For the dimensions of the spacers for oil / air lubrication, refer to Table 9. 4(2) on page 38.
 3. For the discharge intervals of the oil / air, refer to Supplementary table 6 on page 219.

Basic load ratings in case of multiple-row combination bearing

	Basic dynamic load ratings	Basic static load ratings
2-row	$C_r \times 1.62$	$C_{0r} \times 2$
3-row	$C_r \times 2.16$	$C_{0r} \times 3$
4-row	$C_r \times 2.64$	$C_{0r} \times 4$

Speed coefficients in case of multiple-row combination bearing

Combination types	Combination symbols	Preload when mounting			
		Preload S	Preload L	Preload M	Preload H
⊘ ⊘	DB	0.85	0.80	0.65	0.55
⊘ ⊘ ⊘ ⊘	DBB	0.80	0.75	0.60	0.45
⊘ ⊘ ⊘	DBD	0.75	0.70	0.55	0.40

*Speed coefficients also vary depending on the distance of bearings.

1. Angular contact ball bearings

High Ability Ceramic bearings

3NCHAR900 series

Contact angle 30°

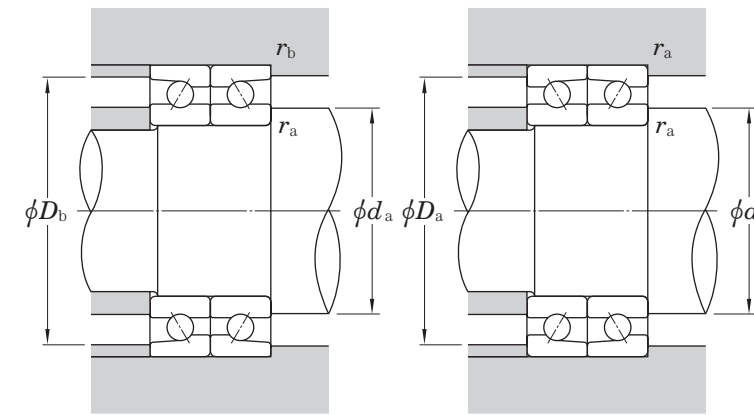
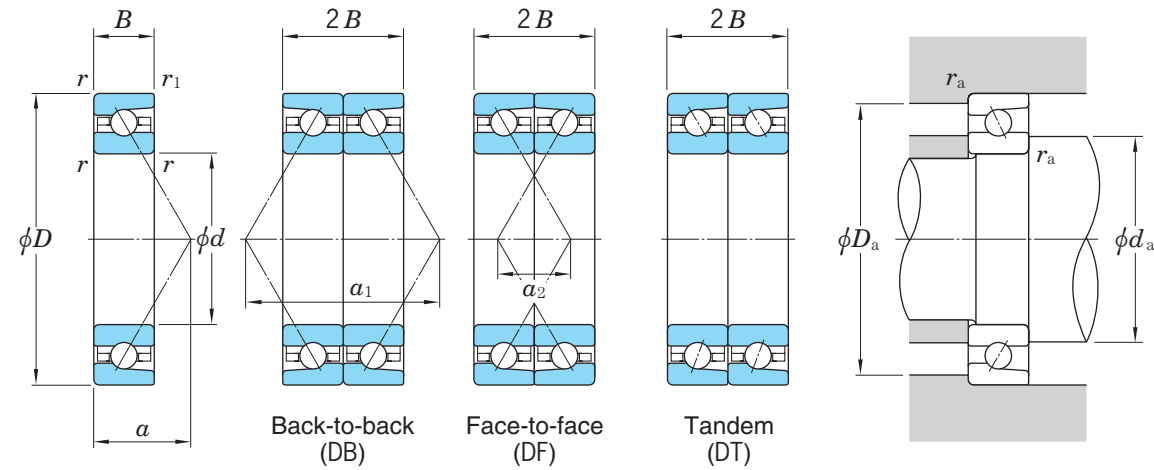

Static equivalent load $P_0 = X_0 F_r + Y_0 F_a$

Contact angle	Single row/Tandem		Back-to-back/Face-to-face	
	X_0	Y_0	X_0	Y_0
30°	0.5	0.33	1	0.66

Note that in the case of single row or tandem, assume $P_0 = F_r$ if $P_0 < F_r$.

Dynamic equivalent load $P = X F_r + Y F_a$

Contact angle	e	Single row/Tandem				Back-to-back/Face-to-face			
		$\frac{F_a}{F_r} \leq e$		$\frac{F_a}{F_r} > e$		$\frac{F_a}{F_r} \leq e$		$\frac{F_a}{F_r} > e$	
		X	Y	X	Y	X	Y	X	Y
30°	0.80	1	0	0.39	0.76	1	0.78	0.63	1.24

Boundary dimensions (mm)					Bearing No.	Basic load ratings (kN)		Limiting speeds (min ⁻¹)		Load center (mm) a	Interspace volume (cm ³ /row)	(Refer.) Mass (kg/row)	Permissible axial loads (kN) (static)	Load center spread of pair-mounted bearings (mm)		Mounting dimensions (mm)					Nut axial tension (N)	Interference of retaining plate (mm)	Bearing No.
d	D	B	r min.	r ₁ min.		C _r	C _{0r}	Grease lub.	Oil lub.					a ₁	a ₂	d _a min.	D _a max.	D _b max.	r _a max.	r _b max.			
40	62	12	0.6	0.3	3NCHAR908	5.75	3.70	21 000	29 000	20.7	4.1	0.109	5.04	41.4	17.4	44.5	57.5	59.5	0.6	0.3	5 000	0.01~0.02	3NCHAR908
45	68	12	0.6	0.3	3NCHAR909	6.15	4.25	19 000	27 000	22.3	4.6	0.129	5.79	44.6	20.6	49.5	63.5	65.5	0.6	0.3	6 000	0.01~0.02	3NCHAR909
50	72	12	0.6	0.3	3NCHAR910	8.25	5.75	17 000	25 000	23.6	5.6	0.122	6.15	47.2	23.2	54.5	67.5	69.5	0.6	0.3	6 000	0.01~0.02	3NCHAR910
55	80	13	1	0.6	3NCHAR911	9.15	6.95	16 000	22 000	26.0	6.5	0.176	8.87	52.0	26.0	60.5	74.5	75.5	1	0.6	6 000	0.01~0.02	3NCHAR911
60	85	13	1	0.6	3NCHAR912	9.00	7.00	14 000	21 000	27.4	7.0	0.189	9.57	54.9	28.9	65.5	79.5	80.5	1	0.6	8 000	0.01~0.02	3NCHAR912
65	90	13	1	0.6	3NCHAR913	10.7	8.55	14 000	19 000	28.9	7.9	0.196	11.6	57.7	31.7	70.5	84.5	85.5	1	0.6	8 000	0.01~0.02	3NCHAR913
70	100	16	1	0.6	3NCHAR914	11.7	9.45	12 000	18 000	32.5	12	0.337	12.9	65.1	33.1	75.5	94.5	95.5	1	0.6	10 000	0.01~0.02	3NCHAR914
75	105	16	1	0.6	3NCHAR915	12.0	10.1	12 000	17 000	34.0	12	0.349	13.8	68.0	36.0	80.5	99.5	100.5	1	0.6	10 000	0.01~0.02	3NCHAR915
80	110	16	1	0.6	3NCHAR916	12.3	10.8	11 000	16 000	35.4	13	0.376	14.7	70.8	38.8	85.5	104.5	105.5	1	0.6	10 000	0.01~0.02	3NCHAR916
85	120	18	1.1	0.6	3NCHAR917	14.8	12.8	9 700	14 000	38.6	18	0.541	17.5	77.2	41.2	92	113	115.5	1	0.6	12 000	0.01~0.02	3NCHAR917
90	125	18	1.1	0.6	3NCHAR918	15.2	13.7	9 300	13 000	40.0	19	0.567	18.6	80.1	44.1	97	118	120.5	1	0.6	12 000	0.01~0.02	3NCHAR918
95	130	18	1.1	0.6	3NCHAR919	15.6	14.5	8 900	13 000	41.5	19	0.593	19.8	83.0	47.0	102	123	125.5	1	0.6	12 000	0.01~0.02	3NCHAR919
100	140	20	1.1	0.6	3NCHAR920	21.9	19.7	8 300	12 000	44.6	28	0.784	26.9	89.3	49.3	107	133	135.5	1	0.6	15 000	0.01~0.02	3NCHAR920
105	145	20	1.1	0.6	3NCHAR921	22.5	20.9	8 000	11 000	46.1	29	0.816	28.5	92.2	52.2	112	138	140.5	1	0.6	15 000	0.02~0.04	3NCHAR921
110	150	20	1.1	0.6	3NCHAR922	22.8	21.6	7 700	11 000	47.5	30	0.849	29.4	95.1	55.1	117	143	145.5	1	0.6	15 000	0.02~0.04	3NCHAR922
120	165	22	1.1	0.6	3NCHAR924	26.6	25.7	7 000	10 000	52.1	40	1.17	35.0	104.3	60.3	127	158	160.5	1	0.6	15 000	0.02~0.04	3NCHAR924
130	180	24	1.5	1	3NCHAR926	31.7	31.8	6 400	9 200	56.7	51	1.56	43.3	113.5	65.5	138.5	171.5	174.5	1.5	1	20 000	0.02~0.04	3NCHAR926
140	190	24	1.5	1	3NCHAR928	31.8	32.8	6 000	8 600	59.6	57	1.65	44.7	119.3	71.3	148.5	181.5	184.5	1.5	1	20 000	0.02~0.04	3NCHAR928
150	210	28	2	1	3NCHAR930	44.3	44.2	5 500	7 900	66.0	85	2.50	60.4	131.9	75.9	160	200	204.5	2	1	20 000	0.02~0.04	3NCHAR930
160	220	28	2	1	3NCHAR932	45.4	46.9	5 000	7 100	68.8	90	2.64	64.0	137.7	81.7	170	210	214.5	2	1	25 000	0.02~0.04	3NCHAR932
170	230	28	2	1	3NCHAR934	46.4	49.6	4 700	6 800	71.7	94	2.77	67.7	143.5	87.5	180	220	224.5	2	1	25 000	0.02~0.04	3NCHAR934

- [Remarks]
- Boundary dimensions of this bearing are the same as those of the 7900 series.
 - For the dimensions of the spacers for oil / air lubrication, refer to Table 9. 4(2) on page 38.
 - For the discharge intervals of the oil / air, refer to Supplementary table 6 on page 219.

Basic load ratings in case of multiple-row combination bearing

	Basic dynamic load ratings	Basic static load ratings
2-row	$C_r \times 1.62$	$C_{0r} \times 2$
3-row	$C_r \times 2.16$	$C_{0r} \times 3$
4-row	$C_r \times 2.64$	$C_{0r} \times 4$

Speed coefficients in case of multiple-row combination bearing

Combination types	Combination symbols	Preload when mounting			
		Preload S	Preload L	Preload M	Preload H
⊘ ⊘	DB	0.85	0.80	0.65	0.55
⊘ ⊘ ⊘ ⊘	DBB	0.80	0.75	0.60	0.45
⊘ ⊘ ⊘	DBD	0.75	0.70	0.55	0.40

*Speed coefficients also vary depending on the distance of bearings.

1. Angular contact ball bearings

High Ability Ceramic bearings

3NCHAR000C series

Contact angle 15°

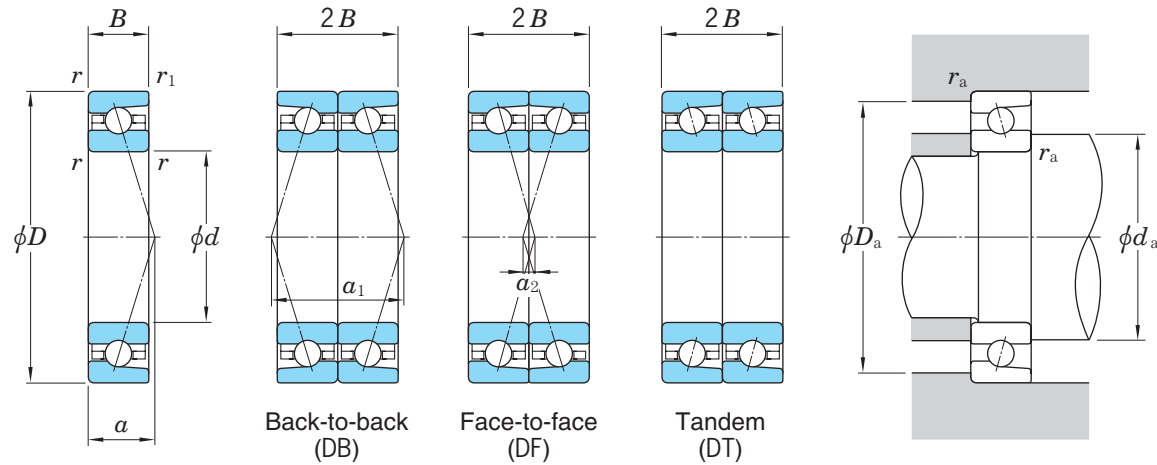

Static equivalent load $P_0 = X_0 F_r + Y_0 F_a$

Contact angle	Single row/Tandem		Back-to-back/Face-to-face	
	X_0	Y_0	X_0	Y_0
15°	0.5	0.46	1	0.92

Note that in the case of single row or tandem, assume $P_0 = F_r$ if $P_0 < F_r$.

Dynamic equivalent load $P = X F_r + Y F_a$

Contact angle	$i_0 F_a / C_{Or}$	e	Single row/Tandem				Back-to-back/Face-to-face				
			$F_a / F_r \leq e$		$F_a / F_r > e$		$F_a / F_r \leq e$		$F_a / F_r > e$		
			X	Y	X	Y	X	Y	X	Y	
15°	0.178	0.38			1.47			1.65			2.39
	0.357	0.40			1.40			1.57			2.28
	0.714	0.43			1.30			1.46			2.11
	1.07	0.46			1.23			1.38			2.00
	1.43	0.47	1	0	0.44	1	1.34	0.72	1.93		
	2.14	0.50			1.12			1.26			1.82
	3.57	0.55			1.02			1.14			1.66
	5.35	0.56			1.00			1.12			1.63
	7.14	0.56			1.00			1.12			1.63

1) For i , use 2 for DB & DF and 1 for single & DT.

Boundary dimensions (mm)					Bearing No.	Basic load ratings (kN)		Factor f_0	Limiting speeds (min^{-1})		Load center (mm) a	Interspace volume (cm^3/row)	(Refer.) Mass (kg/row)	Permissible axial loads (kN) (static)	Load center spread of pair-mounted bearings (mm)		Mounting dimensions (mm)					Nut axial tension (N)	Interference of retaining plate (mm)	Bearing No.
d	D	B	r_{min}	$r_{1\text{min}}$		C_r	C_{Or}		Grease lub.	Oil lub.					a_1	a_2	d_a min.	D_a max.	D_b max.	r_a max.	r_b max.			
30	55	13	1	0.6	3NCHAR006C	8.70	4.85	7.9	35 000	59 000	12.2	4.4	0.107	3.91	24.4	1.6	35.5	49.5	50.5	1	0.6	5 000	0.01~0.02	3NCHAR006C
35	62	14	1	0.6	3NCHAR007C	9.25	5.55	8.1	31 000	52 000	13.5	5.5	0.148	4.47	27.0	1.0	40.5	56.5	57.5	1	0.6	8 000	0.01~0.02	3NCHAR007C
40	68	15	1	0.6	3NCHAR008C	9.70	6.20	8.2	28 000	46 000	14.7	6.6	0.189	5.02	29.5	0.5	45.5	62.5	63.5	1	0.6	8 000	0.01~0.02	3NCHAR008C
45	75	16	1	0.6	3NCHAR009C	10.9	7.10	8.3	25 000	42 000	16.0	8.4	0.237	5.76	32.1	0.1	50.5	69.5	70.5	1	0.6	10 000	0.01~0.02	3NCHAR009C
50	80	16	1	0.6	3NCHAR010C	11.4	7.9	8.4	23 000	38 000	16.7	10	0.258	6.36	33.4	1.4	55.5	74.5	75.5	1	0.6	10 000	0.01~0.02	3NCHAR010C
55	90	18	1.1	0.6	3NCHAR011C	14.1	9.9	8.4	21 000	34 000	18.7	13	0.382	8.03	37.4	1.4	62	83	85.5	1	0.6	12 000	0.01~0.02	3NCHAR011C
60	95	18	1.1	0.6	3NCHAR012C	14.7	10.8	8.5	19 000	32 000	19.4	15	0.410	8.79	38.8	2.8	67	88	90.5	1	0.6	12 000	0.01~0.02	3NCHAR012C
65	100	18	1.1	0.6	3NCHAR013C	15.3	11.8	8.5	18 000	30 000	20.1	16	0.437	9.55	40.1	4.1	72	93	95.5	1	0.6	15 000	0.01~0.02	3NCHAR013C
70	110	20	1.1	0.6	3NCHAR014C	20.7	15.5	8.4	17 000	28 000	22.1	23	0.588	12.5	44.1	4.1	77	103	105.5	1	0.6	15 000	0.01~0.02	3NCHAR014C
75	115	20	1.1	0.6	3NCHAR015C	21.1	16.2	8.5	16 000	26 000	22.7	25	0.623	13.1	45.5	5.5	82	108	110.5	1	0.6	15 000	0.01~0.02	3NCHAR015C
80	125	22	1.1	0.6	3NCHAR016C	24.7	19.2	8.4	14 000	23 000	24.7	31	0.848	15.6	49.5	5.5	87	118	120.5	1	0.6	15 000	0.01~0.02	3NCHAR016C
85	130	22	1.1	0.6	3NCHAR017C	25.1	20.1	8.5	13 000	22 000	25.4	33	0.890	16.3	50.8	6.8	92	123	125.5	1	0.6	18 000	0.01~0.02	3NCHAR017C
90	140	24	1.5	1	3NCHAR018C	32.8	26.1	8.4	12 000	21 000	27.4	43	1.13	21.1	54.8	6.8	98.5	131.5	134.5	1.5	1	18 000	0.01~0.02	3NCHAR018C
95	145	24	1.5	1	3NCHAR019C	33.4	27.2	8.5	12 000	20 000	28.1	45	1.19	22.1	56.2	8.2	103.5	136.5	139.5	1.5	1	18 000	0.01~0.02	3NCHAR019C
100	150	24	1.5	1	3NCHAR020C	34.0	28.4	8.5	11 000	19 000	28.7	47	1.23	23.0	57.5	9.5	108.5	141.5	144.5	1.5	1	20 000	0.01~0.02	3NCHAR020C
105	160	26	2	1	3NCHAR021C	38.6	32.5	8.5	11 000	18 000	30.8	57	1.57	26.4	61.5	9.5	115	150	154.5	2	1	20 000	0.02~0.04	3NCHAR021C
110	170	28	2	1	3NCHAR022C	43.4	37.0	8.5	10 000	17 000	32.8	68	1.97	30.0	65.5	9.5	120	160	164.5	2	1	20 000	0.02~0.04	3NCHAR022C
120	180	28	2	1	3NCHAR024C	44.9	39.9	8.5	9 500	16 000	34.1	73	2.11	32.4	68.2	12.2	130	170	174.5	2	1	20 000	0.02~0.04	3NCHAR024C
130	200	33	2	1	3NCHAR026C	56.3	48.4	8.5	8 600	14 000	38.6	115	3.17	39.2	77.2	11.2	140	190	194.5	2	1	20 000	0.02~0.04	3NCHAR026C
140	210	33	2	1	3NCHAR028C	61.3	56.2	8.5	8 100	14 000	39.9	120	3.37	45.6	79.9	13.9	150	200	204.5	2	1	25 000	0.02~0.04	3NCHAR028C
150	225	35	2	1	3NCHAR030C	72.2	66.1	8.5	7 200	12 000	42.6	150	4.03	53.7	85.2	15.2	160	215	219.5	2	1	25 000	0.02~0.04	3NCHAR030C
160	240	38	2.1	1.1	3NCHAR032C	78.3	72.7	8.5	6 800	11 000	45.8	186	5.02	59.1	91.6	15.6	172	228	233	2	1	30 000	0.02~0.04	3NCHAR032C
170	260	42	2.1	1.1	3NCHAR034C	91.8	86.4	8.5	6 300	10 000	49.8	236	6.83	70.2	99.6	15.6	182	248	253	2	1	30 000	0.02~0.04	3NCHAR034C

- [Remarks]
- Boundary dimensions of this bearing are the same as those of the 7000 series.
 - For the dimensions of the spacers for oil / air lubrication, refer to Table 9. 4(2) on page 38.
 - For the discharge intervals of the oil / air, refer to Supplementary table 6 on page 219.

Basic load ratings in case of multiple-row combination bearing

	Basic dynamic load ratings	Basic static load ratings
2-row	$C_r \times 1.62$	$C_{Or} \times 2$
3-row	$C_r \times 2.16$	$C_{Or} \times 3$
4-row	$C_r \times 2.64$	$C_{Or} \times 4$

Speed coefficients in case of multiple-row combination bearing

Combination types	Combination symbols	Preload when mounting			
		Preload S	Preload L	Preload M	Preload H
$\odot \quad \odot$	DB	0.85	0.80	0.65	0.55
$\odot \odot \quad \odot \odot$	DBB	0.80	0.75	0.60	0.45
$\odot \odot \quad \odot$	DBD	0.75	0.70	0.55	0.40

*Speed coefficients also vary depending on the distance of bearings.

1. Angular contact ball bearings

High Ability Ceramic bearings

3NCHAR000CA series

Contact angle 20°

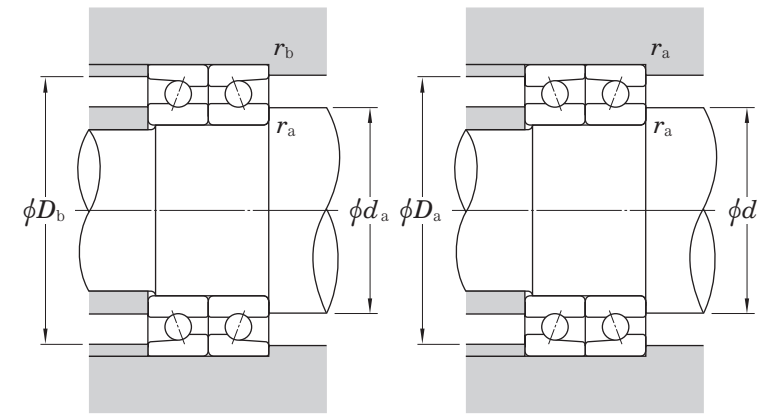
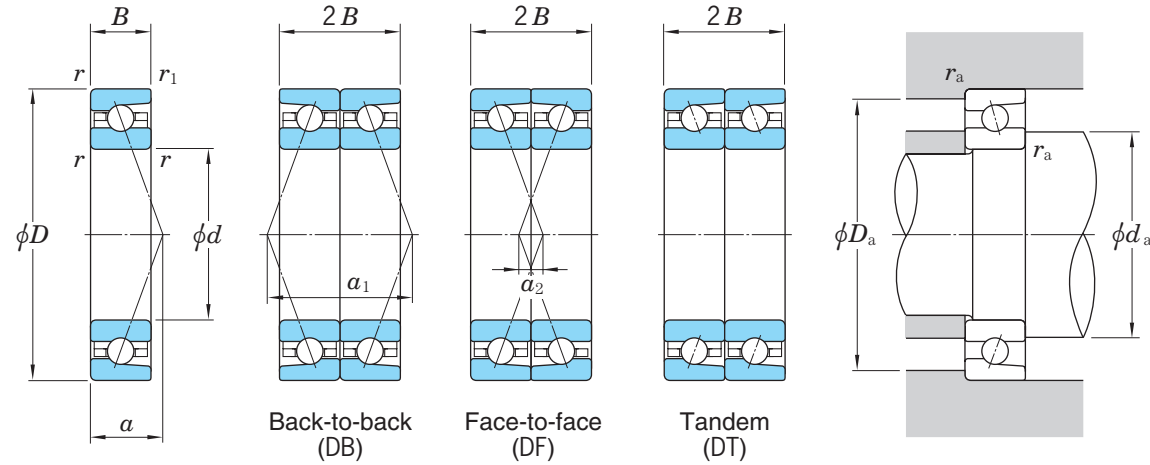

Static equivalent load $P_0 = X_0 F_r + Y_0 F_a$

Contact angle	Single row/Tandem		Back-to-back/Face-to-face	
	X_0	Y_0	X_0	Y_0
20°	0.5	0.42	1	0.84

Note that in the case of single row or tandem, assume $P_0 = F_r$ if $P_0 > F_r$.

Dynamic equivalent load $P = X F_r + Y F_a$

Contact angle	e	Single row/Tandem				Back-to-back/Face-to-face			
		$\frac{F_a}{F_r} \leq e$		$\frac{F_a}{F_r} > e$		$\frac{F_a}{F_r} \leq e$		$\frac{F_a}{F_r} > e$	
		X	Y	X	Y	X	Y	X	Y
20°	0.57	1	0	0.43	1	1	1.09	0.70	1.63

d	Boundary dimensions (mm)				Bearing No.	Basic load ratings (kN)		Limiting speeds (min ⁻¹)		Load center (mm) a	Interspace volume (cm ³ /row)	(Refer.) Mass (kg/row)	Permissible axial loads (kN) (static)	Load center spread of pair-mounted bearings (mm)		Mounting dimensions (mm)					Nut axial tension (N)	Interference of retaining plate (mm)	Bearing No.
	D	B	r min.	r ₁ min.		C _r	C _{0r}	Grease lub.	Oil lub.					a ₁	a ₂	d _a min.	D _a max.	D _b max.	r _a max.	r _b max.			
30	55	13	1	0.6	3NCHAR006CA	8.55	4.75	33 000	55 000	14.2	4.4	0.107	4.78	28.5	2.5	35.5	49.5	50.5	1	0.6	5 000	0.01~0.02	3NCHAR006CA
35	62	14	1	0.6	3NCHAR007CA	9.05	5.40	29 000	48 000	15.8	5.5	0.148	4.90	31.7	3.7	40.5	56.5	57.5	1	0.6	8 000	0.01~0.02	3NCHAR007CA
40	68	15	1	0.6	3NCHAR008CA	9.50	6.05	26 000	44 000	17.3	6.6	0.189	6.10	34.7	4.7	45.5	62.5	63.5	1	0.6	8 000	0.01~0.02	3NCHAR008CA
45	75	16	1	0.6	3NCHAR009CA	10.6	6.95	23 000	39 000	18.9	8.4	0.237	7.00	37.8	5.8	50.5	69.5	70.5	1	0.6	10 000	0.01~0.02	3NCHAR009CA
50	80	16	1	0.6	3NCHAR010CA	11.1	7.65	22 000	36 000	19.8	10	0.258	7.72	39.7	7.7	55.5	74.5	75.5	1	0.6	10 000	0.01~0.02	3NCHAR010CA
55	90	18	1.1	0.6	3NCHAR011CA	13.7	9.70	19 000	32 000	22.2	13	0.382	9.75	44.4	8.4	62	83	85.5	1	0.6	12 000	0.01~0.02	3NCHAR011CA
60	95	18	1.1	0.6	3NCHAR012CA	14.3	10.6	18 000	30 000	23.1	15	0.410	10.6	46.2	10.2	67	88	90.5	1	0.6	12 000	0.01~0.02	3NCHAR012CA
65	100	18	1.1	0.6	3NCHAR013CA	14.9	11.5	17 000	28 000	24.0	16	0.437	11.5	48.0	12.0	72	93	95.5	1	0.6	15 000	0.01~0.02	3NCHAR013CA
70	110	20	1.1	0.6	3NCHAR014CA	20.2	15.1	16 000	26 000	26.4	23	0.588	15.2	52.8	12.8	77	103	105.5	1	0.6	15 000	0.01~0.02	3NCHAR014CA
75	115	20	1.1	0.6	3NCHAR015CA	20.6	15.8	15 000	25 000	27.3	25	0.623	15.9	54.6	14.6	82	108	110.5	1	0.6	15 000	0.01~0.02	3NCHAR015CA
80	125	22	1.1	0.6	3NCHAR016CA	24.1	18.8	13 000	22 000	29.7	31	0.848	18.9	59.3	15.3	87	118	120.5	1	0.6	15 000	0.01~0.02	3NCHAR016CA
85	130	22	1.1	0.6	3NCHAR017CA	24.5	19.6	12 000	21 000	30.6	33	0.890	19.8	61.1	17.1	92	123	125.5	1	0.6	18 000	0.01~0.02	3NCHAR017CA
90	140	24	1.5	1	3NCHAR018CA	32.0	25.4	12 000	19 000	32.9	43	1.13	25.6	65.9	17.9	98.5	131.5	134.5	1.5	1	18 000	0.01~0.02	3NCHAR018CA
95	145	24	1.5	1	3NCHAR019CA	32.6	26.6	11 000	19 000	33.8	45	1.19	26.8	67.7	19.7	103.5	136.5	139.5	1.5	1	18 000	0.01~0.02	3NCHAR019CA
100	150	24	1.5	1	3NCHAR020CA	33.2	27.7	11 000	18 000	34.7	47	1.23	27.9	69.5	21.5	108.5	141.5	144.5	1.5	1	20 000	0.01~0.02	3NCHAR020CA
105	160	26	2	1	3NCHAR021CA	37.6	31.7	10 000	17 000	37.1	57	1.57	32.0	74.2	22.2	115	150	154.5	2	1	20 000	0.02~0.04	3NCHAR021CA
110	170	28	2	1	3NCHAR022CA	42.4	36.1	9 500	16 000	39.5	68	1.97	36.4	79.0	23.0	120	160	164.5	2	1	20 000	0.02~0.04	3NCHAR022CA
120	180	28	2	1	3NCHAR024CA	43.8	39.0	8 900	15 000	41.3	73	2.11	39.3	82.6	26.6	130	170	174.5	2	1	20 000	0.02~0.04	3NCHAR024CA
130	200	33	2	1	3NCHAR026CA	55.0	47.2	8 100	14 000	46.5	115	3.17	47.6	93.1	27.1	140	190	194.5	2	1	20 000	0.02~0.04	3NCHAR026CA
140	210	33	2	1	3NCHAR028CA	59.9	54.8	7 600	13 000	48.3	120	3.37	55.3	96.7	30.7	150	200	204.5	2	1	25 000	0.02~0.04	3NCHAR028CA
150	225	35	2	1	3NCHAR030CA	70.5	64.5	6 700	11 000	51.6	150	4.03	65.1	103.2	33.2	160	215	219.5	2	1	25 000	0.02~0.04	3NCHAR030CA
160	240	38	2.1	1.1	3NCHAR032CA	76.4	71.0	6 300	11 000	55.4	186	5.02	71.6	110.8	34.8	172	228	233	2	1	30 000	0.02~0.04	3NCHAR032CA
170	260	42	2.1	1.1	3NCHAR034CA	89.6	84.3	5 900	9 800	60.1	236	6.83	85.1	120.3	36.3	182	248	253	2	1	30 000	0.02~0.04	3NCHAR034CA

- [Remarks]
- Boundary dimensions of this bearing are the same as those of the 7000 series.
 - For the dimensions of the spacers for oil / air lubrication, refer to Table 9. 4(2) on page 38.
 - For the discharge intervals of the oil / air, refer to Supplementary table 6 on page 219.

Basic load ratings in case of multiple-row combination bearing

	Basic dynamic load ratings	Basic static load ratings
2-row	$C_r \times 1.62$	$C_{0r} \times 2$
3-row	$C_r \times 2.16$	$C_{0r} \times 3$
4-row	$C_r \times 2.64$	$C_{0r} \times 4$

Speed coefficients in case of multiple-row combination bearing

Combination types	Combination symbols	Preload when mounting			
		Preload S	Preload L	Preload M	Preload H
⊗ ⊗	DB	0.85	0.80	0.65	0.55
⊗ ⊗ ⊗ ⊗	DBB	0.80	0.75	0.60	0.45
⊗ ⊗ ⊗	DBD	0.75	0.70	0.55	0.40

*Speed coefficients also vary depending on the distance of bearings.

1. Angular contact ball bearings

High Ability Ceramic bearings

3NCHAR000 series

Contact angle 30°

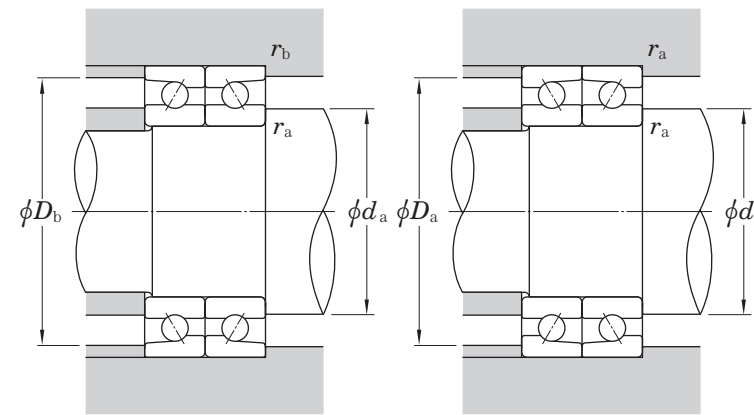
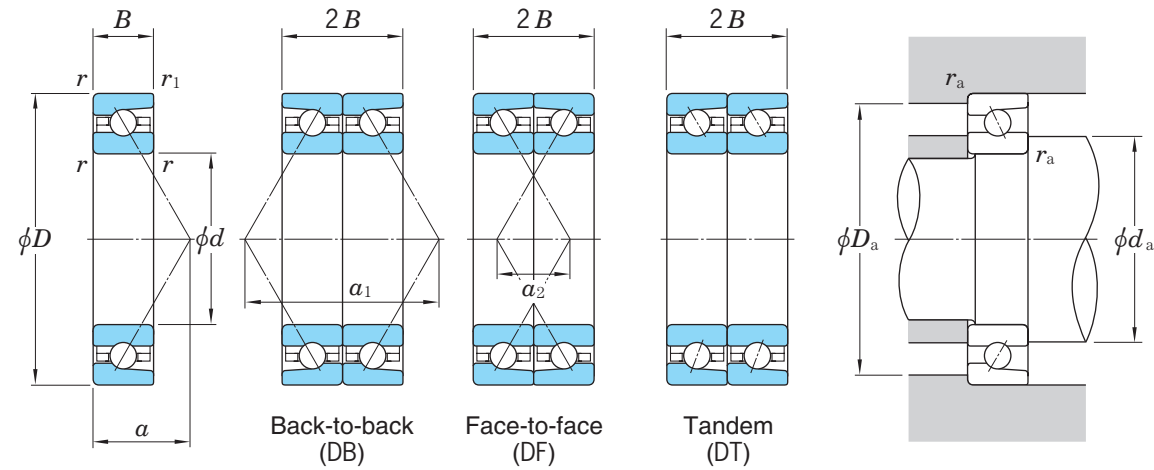

Static equivalent load $P_0 = X_0 F_r + Y_0 F_a$

Contact angle	Single row/Tandem		Back-to-back/Face-to-face	
	X_0	Y_0	X_0	Y_0
30°	0.5	0.33	1	0.66

Note that in the case of single row or tandem, assume $P_0 = F_r$ if $P_0 < F_r$.

Dynamic equivalent load $P = X F_r + Y F_a$

Contact angle	e	Single row/Tandem				Back-to-back/Face-to-face			
		$\frac{F_a}{F_r} \leq e$		$\frac{F_a}{F_r} > e$		$\frac{F_a}{F_r} \leq e$		$\frac{F_a}{F_r} > e$	
		X	Y	X	Y	X	Y	X	Y
30°	0.80	1	0	0.39	0.76	1	0.78	0.63	1.24

d	Boundary dimensions (mm)				Bearing No.	Basic load ratings (kN)		Limiting speeds (min ⁻¹)		Load center (mm) a	Interspace volume (cm ³ /row)	(Refer.) Mass (kg/row)	Permissible axial loads (kN) (static)	Load center spread of pair-mounted bearings (mm)		Mounting dimensions (mm)					Nut axial tension (N)	Interference of retaining plate (mm)	Bearing No.
	D	B	r min.	r ₁ min.		C _r	C _{0r}	Grease lub.	Oil lub.					a ₁	a ₂	d _a min.	D _a max.	D _b max.	r _a max.	r _b max.			
30	55	13	1	0.6	3NCHAR006	8.00	4.45	25 000	35 000	18.8	4.4	0.107	6.06	37.5	11.5	35.5	49.5	50.5	1	0.6	5 000	0.01~0.02	3NCHAR006
35	62	14	1	0.6	3NCHAR007	8.45	5.05	22 000	31 000	21.0	5.5	0.148	6.20	42.0	14.0	40.5	56.5	57.5	1	0.6	8 000	0.01~0.02	3NCHAR007
40	68	15	1	0.6	3NCHAR008	8.85	5.65	19 000	28 000	23.1	6.6	0.189	7.70	46.2	16.2	45.5	62.5	63.5	1	0.6	8 000	0.01~0.02	3NCHAR008
45	75	16	1	0.6	3NCHAR009	9.90	6.45	18 000	25 000	25.3	8.4	0.237	8.82	50.6	18.6	50.5	69.5	70.5	1	0.6	10 000	0.01~0.02	3NCHAR009
50	80	16	1	0.6	3NCHAR010	10.4	7.15	16 000	23 000	26.8	10	0.258	9.72	53.5	21.5	55.5	74.5	75.5	1	0.6	10 000	0.01~0.02	3NCHAR010
55	90	18	1.1	0.6	3NCHAR011	12.8	9.00	14 000	21 000	29.9	13	0.382	12.2	59.9	23.9	62	83	85.5	1	0.6	12 000	0.01~0.02	3NCHAR011
60	95	18	1.1	0.6	3NCHAR012	13.4	9.85	14 000	19 000	31.4	15	0.410	13.4	62.7	26.7	67	88	90.5	1	0.6	12 000	0.01~0.02	3NCHAR012
65	100	18	1.1	0.6	3NCHAR013	13.9	10.7	13 000	18 000	32.8	16	0.437	14.5	65.6	29.6	72	93	95.5	1	0.6	15 000	0.01~0.02	3NCHAR013
70	110	20	1.1	0.6	3NCHAR014	18.9	14.1	12 000	17 000	36.0	23	0.588	19.1	72.0	32.0	77	103	105.5	1	0.6	15 000	0.01~0.02	3NCHAR014
75	115	20	1.1	0.6	3NCHAR015	19.2	14.7	11 000	16 000	37.4	25	0.623	20.0	74.8	34.8	82	108	110.5	1	0.6	15 000	0.01~0.02	3NCHAR015
80	125	22	1.1	0.6	3NCHAR016	22.5	17.5	9 700	14 000	40.6	31	0.848	23.8	81.2	37.2	87	118	120.5	1	0.6	15 000	0.01~0.02	3NCHAR016
85	130	22	1.1	0.6	3NCHAR017	22.8	18.3	9 300	13 000	42.0	33	0.890	24.9	84.1	40.1	92	123	125.5	1	0.6	18 000	0.01~0.02	3NCHAR017
90	140	24	1.5	1	3NCHAR018	29.8	23.7	8 700	12 000	45.2	43	1.13	32.3	90.4	42.4	98.5	131.5	134.5	1.5	1	18 000	0.01~0.02	3NCHAR018
95	145	24	1.5	1	3NCHAR019	30.4	24.7	8 300	12 000	46.6	45	1.19	33.7	93.3	45.3	103.5	136.5	139.5	1.5	1	18 000	0.01~0.02	3NCHAR019
100	150	24	1.5	1	3NCHAR020	30.9	25.8	8 000	11 000	48.1	47	1.23	35.1	96.2	48.2	108.5	141.5	144.5	1.5	1	20 000	0.01~0.02	3NCHAR020
105	160	26	2	1	3NCHAR021	35.0	29.5	7 500	11 000	51.2	57	1.57	40.2	102.5	50.5	115	150	154.5	2	1	20 000	0.02~0.04	3NCHAR021
110	170	28	2	1	3NCHAR022	39.4	33.6	7 100	10 000	54.4	68	1.97	45.8	108.8	52.8	120	160	164.5	2	1	20 000	0.02~0.04	3NCHAR022
120	180	28	2	1	3NCHAR024	40.7	36.2	6 700	9 500	57.3	73	2.11	49.4	114.6	58.6	130	170	174.5	2	1	20 000	0.02~0.04	3NCHAR024
130	200	33	2	1	3NCHAR026	51.2	43.9	6 000	8 600	64.1	115	3.17	59.9	128.3	62.3	140	190	194.5	2	1	20 000	0.02~0.04	3NCHAR026
140	210	33	2	1	3NCHAR028	55.7	51.0	5 700	8 100	67.0	120	3.37	69.5	134.0	68.0	150	200	204.5	2	1	25 000	0.02~0.04	3NCHAR028
150	225	35	2	1	3NCHAR030	65.6	60.0	5 000	7 200	71.6	150	4.03	81.8	143.3	73.3	160	215	219.5	2	1	25 000	0.02~0.04	3NCHAR030
160	240	38	2.1	1.1	3NCHAR032	71.1	66.0	4 700	6 800	76.7	186	5.02	90.0	153.5	77.5	172	228	233	2	1	30 000	0.02~0.04	3NCHAR032
170	260	42	2.1	1.1	3NCHAR034	83.4	78.4	4 400	6 300	83.1	236	6.83	107	166.1	82.1	182	248	253	2	1	30 000	0.02~0.04	3NCHAR034

- [Remarks]
1. Boundary dimensions of this bearing are the same as those of the 7000 series.
 2. For the dimensions of the spacers for oil / air lubrication, refer to Table 9. 4(2) on page 38.
 3. For the discharge intervals of the oil / air, refer to Supplementary table 6 on page 219.

Basic load ratings in case of multiple-row combination bearing

	Basic dynamic load ratings	Basic static load ratings
2-row	$C_r \times 1.62$	$C_{0r} \times 2$
3-row	$C_r \times 2.16$	$C_{0r} \times 3$
4-row	$C_r \times 2.64$	$C_{0r} \times 4$

Speed coefficients in case of multiple-row combination bearing

Combination types	Combination symbols	Preload when mounting			
		Preload S	Preload L	Preload M	Preload H
⊗ ⊗	DB	0.85	0.80	0.65	0.55
⊗ ⊗ ⊗ ⊗	DBB	0.80	0.75	0.60	0.45
⊗ ⊗ ⊗	DBD	0.75	0.70	0.55	0.40

*Speed coefficients also vary depending on the distance of bearings.

1. Angular contact ball bearings

High Ability Ceramic bearings

3NCHAC900C series

Contact angle 15°

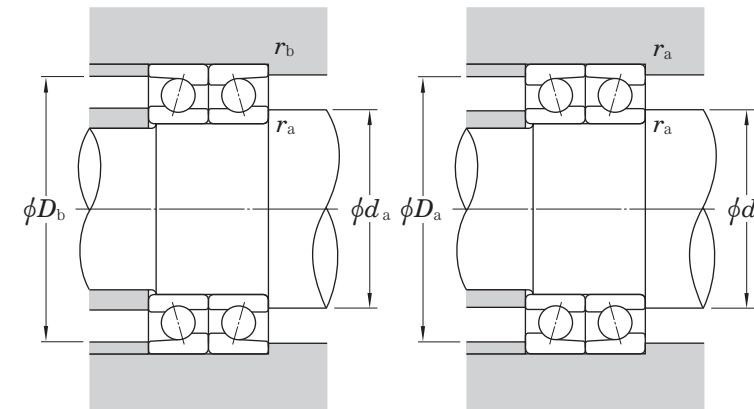
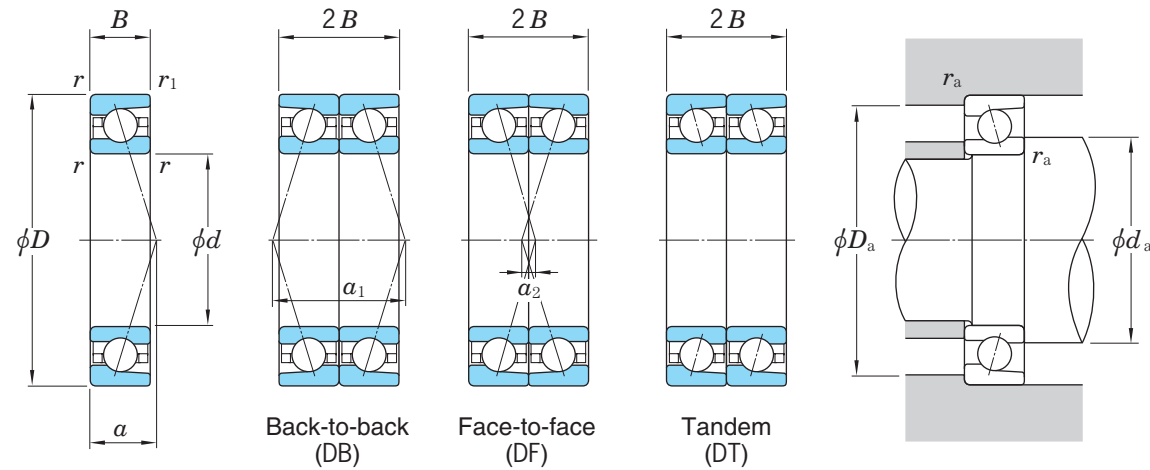

Static equivalent load $P_0 = X_0 F_r + Y_0 F_a$

Contact angle	Single row/Tandem		Back-to-back/Face-to-face	
	X_0	Y_0	X_0	Y_0
15°	0.5	0.46	1	0.92

Note that in the case of single row or tandem, assume $P_0 = F_r$ if $P_0 < F_r$.

Dynamic equivalent load $P = X F_r + Y F_a$

Contact angle	$i f_0 F_a / C_{0r}$	e	Single row/Tandem				Back-to-back/Face-to-face				
			$F_a / F_r \leq e$		$F_a / F_r > e$		$F_a / F_r \leq e$		$F_a / F_r > e$		
			X	Y	X	Y	X	Y	X	Y	
15°	0.178	0.38			1.47			1.65			2.39
	0.357	0.40			1.40			1.57			2.28
	0.714	0.43			1.30			1.46			2.11
	1.07	0.46			1.23			1.38			2.00
	1.43	0.47	1	0	0.44	1	1.34	0.72	1.93		
	2.14	0.50			1.12			1.26			1.82
	3.57	0.55			1.02			1.14			1.66
	5.35	0.56			1.00			1.12			1.63
	7.14	0.56			1.00			1.12			1.63

1) For i , use 2 for DB & DF and 1 for single & DT.

Boundary dimensions (mm)					Bearing No.	Basic load ratings (kN)		Factor f_0	Limiting speeds (min ⁻¹)		Load center (mm) a	Interspace volume (cm ³ /row)	(Refer.) Mass (kg/row)	Permissible axial loads (kN) (static)	Load center spread of pair-mounted bearings (mm)		Mounting dimensions (mm)					Nut axial tension (N)	Interference of retaining plate (mm)	Bearing No.
d	D	B	$r_{min.}$	$r_{1 min.}$		C_r	C_{0r}		Grease lub.	Oil lub.					a_1	a_2	$d_a min.$	$D_a max.$	$D_b max.$	$r_a max.$	$r_b max.$			
10	22	6	0.3	0.15	3NCHAC900C	2.05	0.75	7.2	94 000	156 000	5.1	0.43	0.008	0.62	10.3	1.7	12.5	19.5	20.8	0.3	0.15	1 500	0.01~0.02	3NCHAC900C
12	24	6	0.3	0.15	3NCHAC901C	2.15	0.85	7.1	83 000	139 000	5.4	0.48	0.009	0.70	10.8	1.2	14.5	21.5	22.8	0.3	0.15	2 000	0.01~0.02	3NCHAC901C
15	28	7	0.3	0.15	3NCHAC902C	3.20	1.35	7.4	70 000	116 000	6.4	0.65	0.014	1.07	12.8	1.2	17.5	25.5	26.8	0.3	0.15	2 000	0.01~0.02	3NCHAC902C
17	30	7	0.3	0.15	3NCHAC903C	3.40	1.50	7.6	63 000	104 000	6.7	0.88	0.014	1.20	13.4	0.6	19.5	27.5	28.8	0.3	0.15	3 000	0.01~0.02	3NCHAC903C
20	37	9	0.3	0.15	3NCHAC904C	4.95	2.35	7.6	53 000	88 000	8.3	1.7	0.031	1.86	16.6	1.4	22.5	34.5	35.8	0.3	0.15	3 000	0.01~0.02	3NCHAC904C
25	42	9	0.3	0.15	3NCHAC905C	5.40	2.75	7.9	44 000	73 000	9.1	1.9	0.037	2.23	18.2	0.2	27.5	39.5	40.8	0.3	0.15	3 000	0.01~0.02	3NCHAC905C
30	47	9	0.3	0.15	3NCHAC906C	5.75	3.20	8.1	39 000	65 000	9.7	2.3	0.041	2.57	19.3	1.3	32.5	44.5	45.8	0.3	0.15	5 000	0.01~0.02	3NCHAC906C
35	55	10	0.6	0.3	3NCHAC907C	8.65	4.90	8.0	33 000	56 000	11.0	3.5	0.063	3.96	22.1	2.1	39.5	50.5	52.5	0.6	0.3	5 000	0.01~0.02	3NCHAC907C
40	62	12	0.6	0.3	3NCHAC908C	10.9	6.30	8.0	29 000	49 000	12.8	5.4	0.093	5.10	25.7	1.7	44.5	57.5	59.5	0.6	0.3	5 000	0.01~0.02	3NCHAC908C
45	68	12	0.6	0.3	3NCHAC909C	11.5	7.15	8.1	27 000	44 000	13.6	6.2	0.109	5.78	27.1	3.1	49.5	63.5	65.5	0.6	0.3	6 000	0.01~0.02	3NCHAC909C
50	72	12	0.6	0.3	3NCHAC910C	12.2	7.95	8.2	25 000	41 000	14.2	6.5	0.109	6.45	28.3	4.3	54.5	67.5	69.5	0.6	0.3	6 000	0.01~0.02	3NCHAC910C
55	80	13	1	0.6	3NCHAC911C	13.8	9.40	8.3	22 000	37 000	15.5	8.3	0.154	7.61	31.1	5.1	60.5	74.5	75.5	1	0.6	6 000	0.01~0.02	3NCHAC911C
60	85	13	1	0.6	3NCHAC912C	16.3	11.1	8.3	21 000	34 000	16.3	9.5	0.156	8.95	32.6	6.6	65.5	79.5	80.5	1	0.6	8 000	0.01~0.02	3NCHAC912C
65	90	13	1	0.6	3NCHAC913C	14.7	10.8	8.3	19 000	32 000	16.9	9.2	0.181	8.79	33.8	7.8	70.5	84.5	85.5	1	0.6	8 000	0.01~0.02	3NCHAC913C
70	100	16	1	0.6	3NCHAC914C	20.3	14.7	8.3	18 000	29 000	19.4	15	0.291	11.9	38.8	6.8	75.5	94.5	95.5	1	0.6	10 000	0.01~0.02	3NCHAC914C
75	105	16	1	0.6	3NCHAC915C	20.7	15.5	8.4	17 000	28 000	20.1	16	0.311	12.5	40.1	8.1	80.5	99.5	100.5	1	0.6	10 000	0.01~0.02	3NCHAC915C
80	110	16	1	0.6	3NCHAC916C	21.1	16.2	8.5	16 000	26 000	20.7	17	0.325	13.1	41.5	9.5	85.5	104.5	105.5	1	0.6	10 000	0.01~0.02	3NCHAC916C
85	120	18	1.1	0.6	3NCHAC917C	27.4	20.6	8.4	14 000	23 000	22.7	24	0.473	16.7	45.5	9.5	92	113	115.5	1	0.6	12 000	0.01~0.02	3NCHAC917C
90	125	18	1.1	0.6	3NCHAC918C	27.9	21.6	8.4	13 000	22 000	23.4	27	0.465	17.5	46.8	10.8	97	118	120.5	1	0.6	12 000	0.01~0.02	3NCHAC918C
95	130	18	1.1	0.6	3NCHAC919C	28.5	22.6	8.5	13 000	21 000	24.1	26	0.491	18.3	48.1	12.1	102	123	125.5	1	0.6	12 000	0.01~0.02	3NCHAC919C
100	140	20	1.1	0.6	3NCHAC920C	39.0	29.7	8.3	12 000	20 000	26.1	38	0.632	24.0	52.2	12.2	107	133	135.5	1	0.6	15 000	0.01~0.02	3NCHAC920C
105	145	20	1.1	0.6	3NCHAC921C	39.9	31.2	8.3	11 000	19 000	26.7	40	0.658	25.3	53.5	13.5	112	138	140.5	1	0.6	15 000	0.02~0.04	3NCHAC921C
110	150	20	1.1	0.6	3NCHAC922C	40.7	32.7	8.4	11 000	18 000	27.4	41	0.687	26.5	54.8	14.8	117	143	145.5	1	0.6	15 000	0.02~0.04	3NCHAC922C
120	165	22	1.1	0.6	3NCHAC924C	50.5	41.2	8.4	10 000	17 000	30.1	55	0.934	33.4	60.2	16.2	127	158	160.5	1	0.6	15 000	0.02~0.04	3NCHAC924C
130	180	24	1.5	1	3NCHAC926C	61.2	50.8	8.3	9 200	15 000	32.8	72	1.23	41.1	65.6	17.6	138.5	171.5	174.5	1.5	1	20 000	0.02~0.04	3NCHAC926C
140	190	24	1.5	1	3NCHAC928C	62.3	53.2	8.4	8 600	14 000	34.1	77	1.31	43.2	68.2	20.2	148.5	181.5	184.5	1.5	1	20 000	0.02~0.04	3NCHAC928C
150	210	28	2	1	3NCHAC930C	83.2	69.8	8.3	7 500	12 000	38.1	118	2.00	56.5	76.2	20.2	160	200	204.5	2	1	20 000	0.02~0.04	3NCHAC930C
160	220	28	2	1	3NCHAC932C	84.8	73.3	8.4	7 100	12 000	39.5	124	2.11	59.4	78.9	22.9	170	210	214.5	2	1	25 000	0.02~0.04	3NCHAC932C
170	230	28	2	1	3NCHAC934C	86.4	76.7	8.4	6 700	11 000	40.8	148	3.07	62.3	81.6	25.6	180	220	224.5	2	1	25 000	0.02~0.04	3NCHAC934C

- [Remarks]
1. Boundary dimensions of this bearing are the same as those of the 7900 series.
 2. For the dimensions of the spacers for oil / air lubrication, refer to Table 9. 4(3) on page 39.
 3. For the discharge intervals of the oil / air, refer to Supplementary table 6 on page 219.

Basic load ratings in case of multiple-row combination bearing

	Basic dynamic load ratings	Basic static load ratings
2-row	$C_r \times 1.62$	$C_{0r} \times 2$
3-row	$C_r \times 2.16$	$C_{0r} \times 3$
4-row	$C_r \times 2.64$	$C_{0r} \times 4$

Speed coefficients in case of multiple-row combination bearing

Combination types	Combination symbols	Preload when mounting			
		Preload S	Preload L	Preload M	Preload H
	DB	0.85	0.80	0.65	0.55
	DBB	0.80	0.75	0.60	0.45
	DBD	0.75	0.70	0.55	0.40

*Speed coefficients also vary depending on the distance of bearings.

1. Angular contact ball bearings

High Ability Ceramic bearings

3NCHAC900CA series

Contact angle 20°

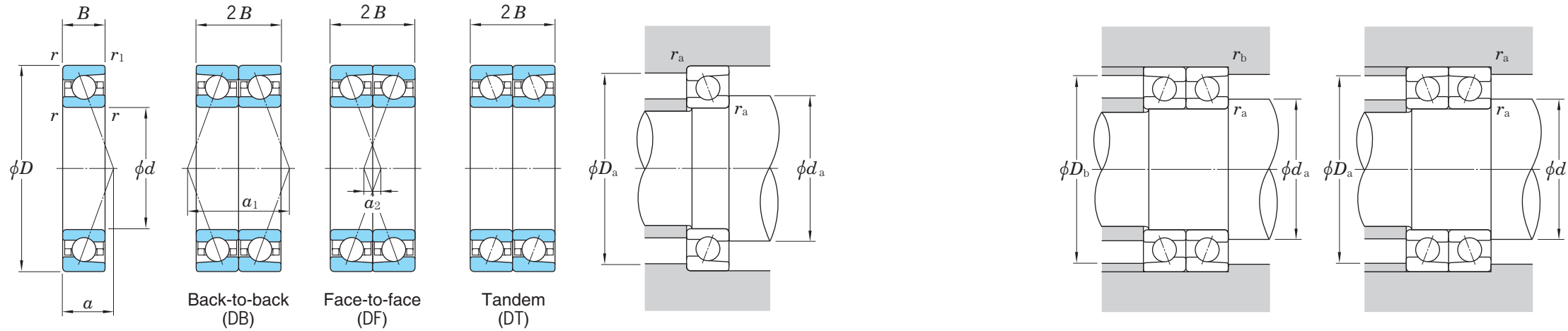

Static equivalent load $P_0 = X_0 F_r + Y_0 F_a$

Contact angle	Single row/Tandem		Back-to-back/Face-to-face	
	X_0	Y_0	X_0	Y_0
20°	0.5	0.42	1	0.84

Note that in the case of single row or tandem, assume $P_0 = F_r$ if $P_0 > F_r$.

Dynamic equivalent load $P = X F_r + Y F_a$

Contact angle	e	Single row/Tandem				Back-to-back/Face-to-face			
		$\frac{F_a}{F_r} \leq e$		$\frac{F_a}{F_r} > e$		$\frac{F_a}{F_r} \leq e$		$\frac{F_a}{F_r} > e$	
		X	Y	X	Y	X	Y	X	Y
20°	0.57	1	0	0.43	1	1	1.09	0.70	1.63

d	Boundary dimensions (mm)				Bearing No.	Basic load ratings (kN)		Limiting speeds (min ⁻¹)		Load center (mm) a	Interspace volume (cm ³ /row)	(Refer.) Mass (kg/row)	Permissible axial loads (kN) (static)	Load center spread of pair-mounted bearings (mm)		Mounting dimensions (mm)					Nut axial tension (N)	Interference of retaining plate (mm)	Bearing No.
	D	B	r min.	r ₁ min.		C _r	C _{0r}	Grease lub.	Oil lub.					a ₁	a ₂	d _a min.	D _a max.	D _b max.	r _a max.	r _b max.			
10	22	6	0.3	0.15	3NCHAC900CA	2.00	0.75	88 000	147 000	5.9	0.43	0.008	0.76	11.8	0.2	12.5	19.5	20.8	0.3	0.15	1 500	0.01~0.02	3NCHAC900CA
12	24	6	0.3	0.15	3NCHAC901CA	2.10	0.85	78 000	131 000	6.3	0.48	0.009	0.86	12.6	0.6	14.5	21.5	22.8	0.3	0.15	2 000	0.01~0.02	3NCHAC901CA
15	28	7	0.3	0.15	3NCHAC902CA	3.15	1.30	65 000	109 000	7.4	0.65	0.014	1.32	14.8	0.8	17.5	25.5	26.8	0.3	0.15	2 000	0.01~0.02	3NCHAC902CA
17	30	7	0.3	0.15	3NCHAC903CA	3.35	1.45	58 000	98 000	7.9	0.88	0.014	1.47	15.7	1.7	19.5	27.5	28.8	0.3	0.15	3 000	0.01~0.02	3NCHAC903CA
20	37	9	0.3	0.15	3NCHAC904CA	4.85	2.30	49 000	82 000	9.7	1.7	0.031	2.14	19.4	1.4	22.5	34.5	35.8	0.3	0.15	3 000	0.01~0.02	3NCHAC904CA
25	42	9	0.3	0.15	3NCHAC905CA	5.30	2.70	41 000	69 000	10.7	1.9	0.037	2.72	21.4	3.4	27.5	39.5	40.8	0.3	0.15	3 000	0.01~0.02	3NCHAC905CA
30	47	9	0.3	0.15	3NCHAC906CA	5.65	3.10	36 000	61 000	11.5	2.3	0.041	3.13	23.0	5.0	32.5	44.5	45.8	0.3	0.15	5 000	0.01~0.02	3NCHAC906CA
35	55	10	0.6	0.3	3NCHAC907CA	8.50	4.80	31 000	52 000	13.2	3.5	0.063	4.83	26.4	6.4	39.5	50.5	52.5	0.6	0.3	5 000	0.01~0.02	3NCHAC907CA
40	62	12	0.6	0.3	3NCHAC908CA	10.6	6.20	27 000	46 000	15.3	5.4	0.093	6.22	30.6	6.6	44.5	57.5	59.5	0.6	0.3	5 000	0.01~0.02	3NCHAC908CA
45	68	12	0.6	0.3	3NCHAC909CA	11.3	7.00	25 000	42 000	16.3	6.2	0.109	7.04	32.6	8.6	49.5	63.5	65.5	0.6	0.3	6 000	0.01~0.02	3NCHAC909CA
50	72	12	0.6	0.3	3NCHAC910CA	12.2	7.95	23 000	39 000	17.1	6.5	0.109	7.85	34.2	10.2	54.5	67.5	69.5	0.6	0.3	6 000	0.01~0.02	3NCHAC910CA
55	80	13	1	0.6	3NCHAC911CA	13.5	9.20	21 000	35 000	18.8	8.3	0.154	9.25	37.6	11.6	60.5	74.5	75.5	1	0.6	6 000	0.01~0.02	3NCHAC911CA
60	85	13	1	0.6	3NCHAC912CA	15.9	10.8	19 000	32 000	19.8	9.5	0.156	10.8	39.6	13.6	65.5	79.5	80.5	1	0.6	8 000	0.01~0.02	3NCHAC912CA
65	90	13	1	0.6	3NCHAC913CA	14.3	10.6	18 000	30 000	20.6	9.2	0.181	10.6	41.2	15.2	70.5	84.5	85.5	1	0.6	8 000	0.01~0.02	3NCHAC913CA
70	100	16	1	0.6	3NCHAC914CA	19.9	14.4	16 000	28 000	23.5	15	0.291	14.5	46.9	14.9	75.5	94.5	95.5	1	0.6	10 000	0.01~0.02	3NCHAC914CA
75	105	16	1	0.6	3NCHAC915CA	20.2	15.1	16 000	26 000	24.4	16	0.311	15.2	48.8	16.8	80.5	99.5	100.5	1	0.6	10 000	0.01~0.02	3NCHAC915CA
80	110	16	1	0.6	3NCHAC916CA	20.6	15.8	15 000	25 000	25.3	17	0.325	15.9	50.6	18.6	85.5	104.5	105.5	1	0.6	10 000	0.01~0.02	3NCHAC916CA
85	120	18	1.1	0.6	3NCHAC917CA	26.7	20.1	13 000	22 000	27.6	24	0.473	20.3	55.3	19.3	92	113	115.5	1	0.6	12 000	0.01~0.02	3NCHAC917CA
90	125	18	1.1	0.6	3NCHAC918CA	27.3	21.1	12 000	21 000	28.6	27	0.465	21.2	57.1	21.1	97	118	120.5	1	0.6	12 000	0.01~0.02	3NCHAC918CA
95	130	18	1.1	0.6	3NCHAC919CA	27.8	22.1	12 000	20 000	29.5	26	0.491	22.2	58.9	22.9	102	123	125.5	1	0.6	12 000	0.01~0.02	3NCHAC919CA
100	140	20	1.1	0.6	3NCHAC920CA	38.1	29.0	11 000	19 000	31.8	38	0.632	29.2	63.7	23.7	107	133	135.5	1	0.6	15 000	0.01~0.02	3NCHAC920CA
105	145	20	1.1	0.6	3NCHAC921CA	38.9	30.5	11 000	18 000	32.7	40	0.658	30.7	65.5	25.5	112	138	140.5	1	0.6	15 000	0.02~0.04	3NCHAC921CA
110	150	20	1.1	0.6	3NCHAC922CA	39.8	31.9	10 000	17 000	33.7	41	0.687	32.1	67.3	27.3	117	143	145.5	1	0.6	15 000	0.02~0.04	3NCHAC922CA
120	165	22	1.1	0.6	3NCHAC924CA	49.3	40.3	9 300	16 000	36.9	55	0.934	40.5	73.9	29.9	127	158	160.5	1	0.6	15 000	0.02~0.04	3NCHAC924CA
130	180	24	1.5	1	3NCHAC926CA	59.8	49.6	8 600	14 000	40.3	72	1.23	49.9	80.5	32.5	138.5	171.5	174.5	1.5	1	20 000	0.02~0.04	3NCHAC926CA
140	190	24	1.5	1	3NCHAC928CA	60.8	52.0	8 100	14 000	42.0	77	1.31	52.4	84.1	36.1	148.5	181.5	184.5	1.5	1	20 000	0.02~0.04	3NCHAC928CA
150	210	28	2	1	3NCHAC930CA	81.3	68.2	7 000	12 000	46.8	118	2.00	68.7	93.5	37.5	160	200	204.5	2	1	20 000	0.02~0.04	3NCHAC930CA
160	220	28	2	1	3NCHAC932CA	82.8	71.6	6 600	11 000	48.6	124	2.11	72.1	97.2	41.2	170	210	214.5	2	1	25 000	0.02~0.04	3NCHAC932CA
170	230	28	2	1	3NCHAC934CA	84.3	74.9	6 300	11 000	50.4	148	3.07	75.6	100.8	44.8	180	220	224.5	2	1	25 000	0.02~0.04	3NCHAC934CA

- [Remarks] 1. Boundary dimensions of this bearing are the same as those of the 7900 series.
 2. For the dimensions of the spacers for oil / air lubrication, refer to Table 9. 4(3) on page 39.
 3. For the discharge intervals of the oil / air, refer to Supplementary table 6 on page 219.

Basic load ratings in case of multiple-row combination bearing

	Basic dynamic load ratings	Basic static load ratings
2-row	$C_r \times 1.62$	$C_{0r} \times 2$
3-row	$C_r \times 2.16$	$C_{0r} \times 3$
4-row	$C_r \times 2.64$	$C_{0r} \times 4$

Speed coefficients in case of multiple-row combination bearing

Combination types	Combination symbols	Preload when mounting			
		Preload S	Preload L	Preload M	Preload H
⊗ ⊗ ⊗ ⊗	DB	0.85	0.80	0.65	0.55
⊗ ⊗ ⊗ ⊗ ⊗	DBB	0.80	0.75	0.60	0.45
⊗ ⊗ ⊗ ⊗ ⊗ ⊗	DBD	0.75	0.70	0.55	0.40

*Speed coefficients also vary depending on the distance of bearings.

1. Angular contact ball bearings

High Ability Ceramic bearings

3NCHAC000C series

Contact angle 15°

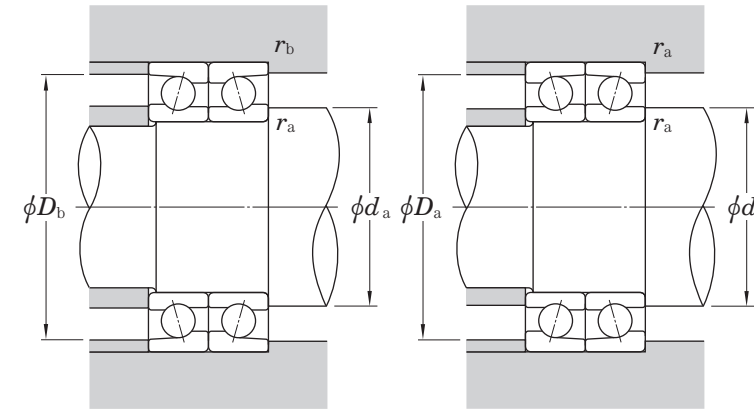
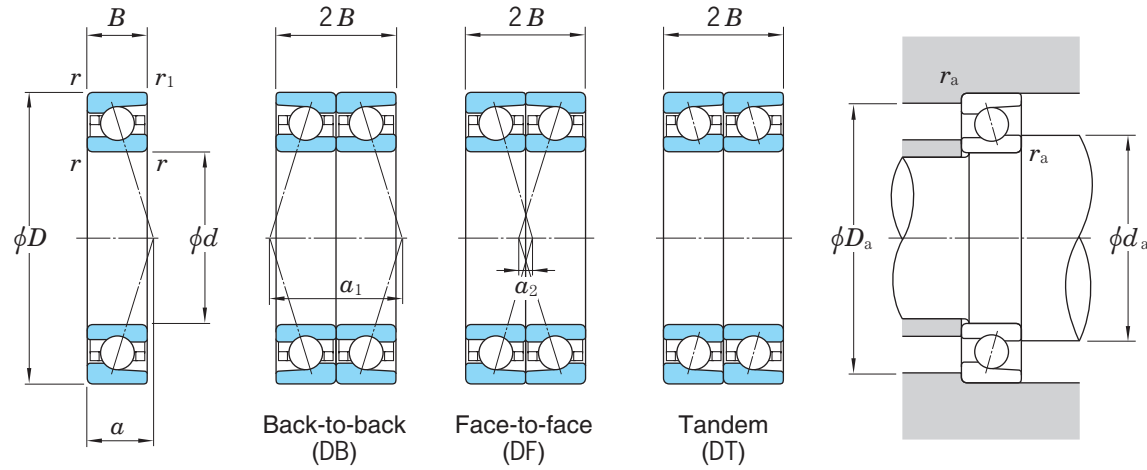

Static equivalent load $P_0 = X_0 F_r + Y_0 F_a$

Contact angle	Single row/Tandem		Back-to-back/Face-to-face	
	X_0	Y_0	X_0	Y_0
15°	0.5	0.46	1	0.92

Note that in the case of single row or tandem, assume $P_0 = F_r$ if $P_0 < F_r$.

Dynamic equivalent load $P = X F_r + Y F_a$

Contact angle	$i_0 F_a / C_{0r}$	e	Single row/Tandem		Back-to-back/Face-to-face			
			$F_a / F_r \leq e$		$F_a / F_r > e$			
			X	Y	X	Y	X	Y
15°	0.178	0.38			1.47	1.65		2.39
	0.357	0.40			1.40	1.57		2.28
	0.714	0.43			1.30	1.46		2.11
	1.07	0.46			1.23	1.38		2.00
	1.43	0.47	1	0	1.19	1.34	0.72	1.93
	2.14	0.50			1.12	1.26		1.82
	3.57	0.55			1.02	1.14		1.66
	5.35	0.56			1.00	1.12		1.63
	7.14	0.56			1.00	1.12		1.63

1) For i , use 2 for DB & DF and 1 for single & DT.

Boundary dimensions (mm)					Bearing No.	Basic load ratings (kN)		Factor f_0	Limiting speeds (min ⁻¹)		Load center (mm) a	Interspace volume (cm ³ /row)	(Refer.) Mass (kg/row)	Permissible axial loads (kN) (static)	Load center spread of pair-mounted bearings (mm)		Mounting dimensions (mm)					Nut axial tension (N)	Interference of retaining plate (mm)	Bearing No.
d	D	B	$r_{min.}$	$r_{1min.}$		C_r	C_{0r}		Grease lub.	Oil lub.					a_1	a_2	d_a min.	D_a max.	D_b max.	r_a max.	r_b max.			
10	26	8	0.3	0.15	3NCHAC000C	3.50	1.25	6.4	85 000	141 000	6.4	0.92	0.016	0.99	12.7	3.3	12.5	23.5	24.8	0.3	0.15	2 000	0.01~0.02	3NCHAC000C
12	28	8	0.3	0.15	3NCHAC001C	3.90	1.50	6.8	73 000	122 000	6.7	1.1	0.017	1.18	13.5	2.5	14.5	25.5	26.8	0.3	0.15	2 000	0.01~0.02	3NCHAC001C
15	32	9	0.3	0.15	3NCHAC002C	4.45	1.90	7.2	64 000	106 000	7.6	1.4	0.026	1.50	15.3	2.7	17.5	29.5	30.8	0.3	0.15	3 000	0.01~0.02	3NCHAC002C
17	35	10	0.3	0.15	3NCHAC003C	4.95	2.30	7.4	57 000	94 000	8.6	1.7	0.035	1.82	17.1	2.9	19.5	32.5	33.8	0.3	0.15	3 000	0.01~0.02	3NCHAC003C
20	42	12	0.6	0.3	3NCHAC004C	7.50	3.35	7.2	48 000	79 000	10.2	3.4	0.056	2.67	20.4	3.6	24.5	37.5	39.5	0.6	0.3	5 000	0.01~0.02	3NCHAC004C
25	47	12	0.6	0.3	3NCHAC005C	8.35	4.10	7.5	42 000	69 000	10.8	3.8	0.066	3.26	21.7	2.3	29.5	42.5	44.5	0.6	0.3	5 000	0.01~0.02	3NCHAC005C
30	55	13	1	0.6	3NCHAC006C	10.8	5.60	7.6	35 000	59 000	12.2	5.4	0.097	4.48	24.4	1.6	35.5	49.5	50.5	1	0.6	5 000	0.01~0.02	3NCHAC006C
35	62	14	1	0.6	3NCHAC007C	13.0	7.00	7.6	31 000	51 000	13.6	7.1	0.129	5.59	27.1	0.9	40.5	56.5	57.5	1	0.6	8 000	0.01~0.02	3NCHAC007C
40	68	15	1	0.6	3NCHAC008C	14.1	8.10	7.8	28 000	46 000	14.7	8.7	0.161	6.50	29.5	0.5	45.5	62.5	63.5	1	0.6	8 000	0.01~0.02	3NCHAC008C
45	75	16	1	0.6	3NCHAC009C	16.8	9.80	7.8	25 000	42 000	16.0	11	0.205	7.89	32.1	0.1	50.5	69.5	70.5	1	0.6	10 000	0.01~0.02	3NCHAC009C
50	80	16	1	0.6	3NCHAC010C	17.9	11.2	8.0	23 000	38 000	16.8	12	0.219	9.00	33.6	1.6	55.5	74.5	75.5	1	0.6	10 000	0.01~0.02	3NCHAC010C
55	90	18	1.1	0.6	3NCHAC011C	23.5	14.6	7.9	21 000	34 000	18.7	17	0.319	11.7	37.4	1.4	62	83	85.5	1	0.6	12 000	0.01~0.02	3NCHAC011C
60	95	18	1.1	0.6	3NCHAC012C	24.2	15.6	8.0	19 000	32 000	19.4	19	0.340	12.5	38.8	2.8	67	88	90.5	1	0.6	12 000	0.01~0.02	3NCHAC012C
65	100	18	1.1	0.6	3NCHAC013C	25.7	17.5	8.1	18 000	30 000	20.1	20	0.365	14.0	40.2	4.2	72	93	95.5	1	0.6	15 000	0.01~0.02	3NCHAC013C
70	110	20	1.1	0.6	3NCHAC014C	32.4	21.9	8.0	17 000	28 000	22.1	28	0.500	17.6	44.1	4.1	77	103	105.5	1	0.6	15 000	0.01~0.02	3NCHAC014C
75	115	20	1.1	0.6	3NCHAC015C	33.3	23.2	8.1	16 000	26 000	22.7	28	0.539	18.7	45.5	5.5	82	108	110.5	1	0.6	15 000	0.01~0.02	3NCHAC015C
80	125	22	1.1	0.6	3NCHAC016C	40.6	28.1	8.0	14 000	23 000	24.7	38	0.714	22.6	49.5	5.5	87	118	120.5	1	0.6	15 000	0.01~0.02	3NCHAC016C
85	130	22	1.1	0.6	3NCHAC017C	41.7	29.8	8.1	13 000	22 000	25.5	40	0.741	24.0	51.1	7.1	92	123	125.5	1	0.6	18 000	0.01~0.02	3NCHAC017C
90	140	24	1.5	1	3NCHAC018C	49.6	35.2	8.0	12 000	21 000	27.4	51	0.943	28.3	54.8	6.8	98.5	131.5	134.5	1.5	1	18 000	0.01~0.02	3NCHAC018C
95	145	24	1.5	1	3NCHAC019C	50.9	37.3	8.1	12 000	19 000	28.3	55	0.960	30.1	56.7	8.7	103.5	136.5	139.5	1.5	1	18 000	0.01~0.02	3NCHAC019C
100	150	24	1.5	1	3NCHAC020C	52.4	39.3	8.1	11 000	19 000	28.7	56	1.03	31.7	57.5	9.5	108.5	141.5	144.5	1.5	1	20 000	0.01~0.02	3NCHAC020C
105	160	26	2	1	3NCHAC021C	61.0	45.6	8.1	11 000	18 000	31.0	71	1.28	36.7	62.0	10.0	115	150	154.5	2	1	20 000	0.02~0.04	3NCHAC021C
110	170	28	2	1	3NCHAC022C	69.9	51.6	8.0	10 000	17 000	32.8	89	1.60	41.6	65.5	9.5	120	160	164.5	2	1	20 000	0.02~0.04	3NCHAC022C
120	180	28	2	1	3NCHAC024C	74.0	57.5	8.1	9 500	16 000	34.1	95	1.72	46.4	68.2	12.2	130	170	174.5	2	1	20 000	0.02~0.04	3NCHAC024C
130	200	33	2	1	3NCHAC026C	89.7	69.7	8.1	8 600	14 000	38.6	139	2.68	56.3	77.2	11.2	140	190	194.5	2	1	20 000	0.02~0.04	3NCHAC026C
140	210	33	2	1	3NCHAC028C	91.9	73.8	8.2	8 100	14 000	40.0	146	2.84	59.6	79.9	13.9	150	200	204.5	2	1	25 000	0.02~0.04	3NCHAC028C
150	225	35	2.1	1.1	3NCHAC030C	105	85.7	8.2	7 100	12 000	42.8	176	3.44	69.2	85.6	15.6	162	213	218	2	1	25 000	0.02~0.04	3NCHAC030C
160	240	38	2.1	1.1	3NCHAC032C	119	98.1	8.1	6 700	11 000	45.8	223	4.23	79.3	91.6	15.6	172	228	233	2	1	30 000	0.02~0.04	3NCHAC032C
170	260	42	2.1	1.1	3NCHAC034C	142	119	8.1	6 300	10 000	49.8	299	5.76	96.2	99.6	15.6	182	248	253	2	1	30 000	0.02~0.04	3NCHAC034C

- [Remarks]
1. Boundary dimensions of this bearing are the same as those of the 7000 series.
 2. For the dimensions of the spacers for oil / air lubrication, refer to Table 9. 4(3) on page 39.
 3. For the discharge intervals of the oil / air, refer to Supplementary table 6 on page 219.

Basic load ratings in case of multiple-row combination bearing

	Basic dynamic load ratings	Basic static load ratings
2-row	$C_r \times 1.62$	$C_{0r} \times 2$
3-row	$C_r \times 2.16$	$C_{0r} \times 3$
4-row	$C_r \times 2.64$	$C_{0r} \times 4$

Speed coefficients in case of multiple-row combination bearing

Combination types	Combination symbols	Preload when mounting			
		Preload S	Preload L	Preload M	Preload H
⊗ ⊗ ⊗	DB	0.85	0.80	0.65	0.55
⊗ ⊗ ⊗ ⊗	DBB	0.80	0.75	0.60	0.45
⊗ ⊗ ⊗	DBD	0.75	0.70	0.55	0.40

*Speed coefficients also vary depending on the distance of bearings.

1. Angular contact ball bearings

High Ability Ceramic bearings

3NCHAC000CA series

Contact angle 20°

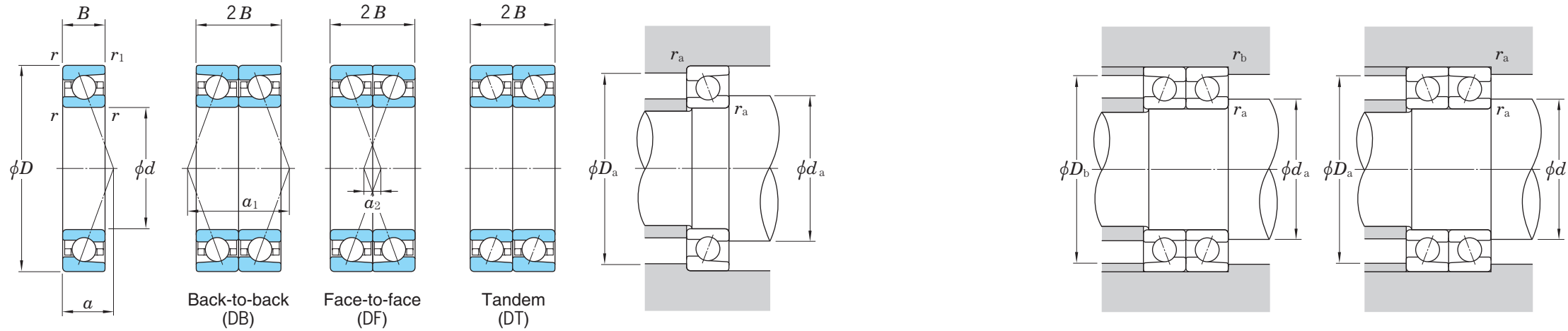

Static equivalent load $P_0 = X_0 F_r + Y_0 F_a$

Contact angle	Single row/Tandem		Back-to-back/Face-to-face	
	X_0	Y_0	X_0	Y_0
20°	0.5	0.42	1	0.84

Note that in the case of single row or tandem, assume $P_0 = F_r$ if $P_0 > F_r$.

Dynamic equivalent load $P = X F_r + Y F_a$

Contact angle	e	Single row/Tandem				Back-to-back/Face-to-face			
		$\frac{F_a}{F_r} \leq e$		$\frac{F_a}{F_r} > e$		$\frac{F_a}{F_r} \leq e$		$\frac{F_a}{F_r} > e$	
		X	Y	X	Y	X	Y	X	Y
20°	0.57	1	0	0.43	1	1	1.09	0.70	1.63

Boundary dimensions (mm)					Bearing No.	Basic load ratings (kN)		Limiting speeds (min ⁻¹)		Load center (mm) a	Interspace volume (cm ³ /row)	(Refer.) Mass (kg/row)	Permissible axial loads (kN) (static)	Load center spread of pair-mounted bearings (mm)		Mounting dimensions (mm)					Nut axial tension (N)	Interference of retaining plate (mm)	Bearing No.
d	D	B	$r_{min.}$	$r_{1 min.}$		C_r	C_{0r}	Grease lub.	Oil lub.					α_1	α_2	$d_a min.$	$D_a max.$	$D_b max.$	$r_a max.$	$r_b max.$			
10	26	8	0.3	0.15	3NCHAC000CA	3.50	1.25	79 000	133 000	7.2	0.92	0.016	1.24	14.4	1.6	12.5	23.5	24.8	0.3	0.15	2 000	0.01~0.02	3NCHAC000CA
12	28	8	0.3	0.15	3NCHAC001CA	3.85	1.45	68 000	115 000	7.7	1.1	0.017	1.46	15.5	0.5	14.5	25.5	26.8	0.3	0.15	2 000	0.01~0.02	3NCHAC001CA
15	32	9	0.3	0.15	3NCHAC002CA	4.40	1.85	60 000	100 000	8.8	1.4	0.026	1.85	17.6	0.4	17.5	29.5	30.8	0.3	0.15	3 000	0.01~0.02	3NCHAC002CA
17	35	10	0.3	0.15	3NCHAC003CA	4.85	2.25	53 000	89 000	9.8	1.7	0.035	2.14	19.6	0.4	19.5	32.5	33.8	0.3	0.15	3 000	0.01~0.02	3NCHAC003CA
20	42	12	0.6	0.3	3NCHAC004CA	7.35	3.30	44 000	75 000	11.7	3.4	0.056	3.29	23.5	0.5	24.5	37.5	39.5	0.6	0.3	5 000	0.01~0.02	3NCHAC004CA
25	47	12	0.6	0.3	3NCHAC005CA	8.20	4.00	39 000	65 000	12.6	3.8	0.066	4.00	25.1	1.1	29.5	42.5	44.5	0.6	0.3	5 000	0.01~0.02	3NCHAC005CA
30	55	13	1	0.6	3NCHAC006CA	10.6	5.50	33 000	55 000	14.2	5.4	0.097	5.49	28.5	2.5	35.5	49.5	50.5	1	0.6	5 000	0.01~0.02	3NCHAC006CA
35	62	14	1	0.6	3NCHAC007CA	12.8	6.85	29 000	48 000	15.9	7.1	0.129	6.85	31.8	3.8	40.5	56.5	57.5	1	0.6	8 000	0.01~0.02	3NCHAC007CA
40	68	15	1	0.6	3NCHAC008CA	13.8	7.90	26 000	44 000	17.3	8.7	0.161	7.95	34.7	4.7	45.5	62.5	63.5	1	0.6	8 000	0.01~0.02	3NCHAC008CA
45	75	16	1	0.6	3NCHAC009CA	16.4	9.60	23 000	39 000	18.9	11	0.205	9.64	37.8	5.8	50.5	69.5	70.5	1	0.6	10 000	0.01~0.02	3NCHAC009CA
50	80	16	1	0.6	3NCHAC010CA	17.6	10.9	21 000	36 000	19.9	12	0.219	10.9	39.8	7.8	55.5	74.5	75.5	1	0.6	10 000	0.01~0.02	3NCHAC010CA
55	90	18	1.1	0.6	3NCHAC011CA	23.0	14.3	19 000	32 000	22.2	17	0.319	14.3	44.4	8.4	62	83	85.5	1	0.6	12 000	0.01~0.02	3NCHAC011CA
60	95	18	1.1	0.6	3NCHAC012CA	23.7	15.3	18 000	30 000	23.1	19	0.340	15.3	46.2	10.2	67	88	90.5	1	0.6	12 000	0.01~0.02	3NCHAC012CA
65	100	18	1.1	0.6	3NCHAC013CA	25.2	17.1	17 000	28 000	24.1	20	0.365	17.1	48.2	12.2	72	93	95.5	1	0.6	15 000	0.01~0.02	3NCHAC013CA
70	110	20	1.1	0.6	3NCHAC014CA	31.7	21.4	16 000	26 000	26.4	28	0.500	21.5	52.8	12.8	77	103	105.5	1	0.6	15 000	0.01~0.02	3NCHAC014CA
75	115	20	1.1	0.6	3NCHAC015CA	32.6	22.7	15 000	25 000	27.3	28	0.539	22.8	54.6	14.6	82	108	110.5	1	0.6	15 000	0.01~0.02	3NCHAC015CA
80	125	22	1.1	0.6	3NCHAC016CA	39.7	27.5	13 000	22 000	29.7	38	0.714	27.6	59.3	15.3	87	118	120.5	1	0.6	15 000	0.01~0.02	3NCHAC016CA
85	130	22	1.1	0.6	3NCHAC017CA	40.8	29.2	12 000	21 000	30.7	40	0.741	29.3	61.5	17.5	92	123	125.5	1	0.6	18 000	0.01~0.02	3NCHAC017CA
90	140	24	1.5	1	3NCHAC018CA	48.5	34.4	12 000	19 000	32.9	51	0.943	34.5	65.9	17.9	98.5	131.5	134.5	1.5	1	18 000	0.01~0.02	3NCHAC018CA
95	145	24	1.5	1	3NCHAC019CA	49.8	36.5	11 000	18 000	34.2	55	0.960	36.7	68.4	20.4	103.5	136.5	139.5	1.5	1	18 000	0.01~0.02	3NCHAC019CA
100	150	24	1.5	1	3NCHAC020CA	51.2	38.4	11 000	18 000	34.7	56	1.03	38.6	69.5	21.5	108.5	141.5	144.5	1.5	1	20 000	0.01~0.02	3NCHAC020CA
105	160	26	2	1	3NCHAC021CA	59.6	44.6	9 900	17 000	37.5	71	1.28	44.8	75.0	23.0	115	150	154.5	2	1	20 000	0.02~0.04	3NCHAC021CA
110	170	28	2	1	3NCHAC022CA	68.4	50.4	9 500	16 000	39.5	89	1.60	50.7	79.0	23.0	120	160	164.5	2	1	20 000	0.02~0.04	3NCHAC022CA
120	180	28	2	1	3NCHAC024CA	72.3	56.2	8 900	15 000	41.3	95	1.72	56.5	82.6	26.6	130	170	174.5	2	1	20 000	0.02~0.04	3NCHAC024CA
130	200	33	2	1	3NCHAC026CA	87.7	68.2	8 100	14 000	46.5	139	2.68	68.6	93.1	27.1	140	190	194.5	2	1	20 000	0.02~0.04	3NCHAC026CA
140	210	33	2	1	3NCHAC028CA	89.8	72.1	7 600	13 000	48.4	146	2.84	72.6	96.7	30.7	150	200	204.5	2	1	25 000	0.02~0.04	3NCHAC028CA
150	225	35	2.1	1.1	3NCHAC030CA	103	83.7	6 700	11 000	51.9	176	3.44	84.2	103.8	33.8	162	213	218	2	1	25 000	0.02~0.04	3NCHAC030CA
160	240	38	2.1	1.1	3NCHAC032CA	116	95.9	6 300	11 000	55.4	223	4.23	96.5	110.8	34.8	172	228	233	2	1	30 000	0.02~0.04	3NCHAC032CA
170	260	42	2.1	1.1	3NCHAC034CA	139	117	5 900	9 800	60.1	299	5.76	117	120.3	36.3	182	248	253	2	1	30 000	0.02~0.04	3NCHAC034CA

- [Remarks]
- Boundary dimensions of this bearing are the same as those of the 7000 series.
 - For the dimensions of the spacers for oil / air lubrication, refer to Table 9. 4(3) on page 39.
 - For the discharge intervals of the oil / air, refer to Supplementary table 6 on page 219.

Basic load ratings in case of multiple-row combination bearing

	Basic dynamic load ratings	Basic static load ratings
2-row	$C_r \times 1.62$	$C_{0r} \times 2$
3-row	$C_r \times 2.16$	$C_{0r} \times 3$
4-row	$C_r \times 2.64$	$C_{0r} \times 4$

Speed coefficients in case of multiple-row combination bearing

Combination types	Combination symbols	Preload when mounting			
		Preload S	Preload L	Preload M	Preload H
$\odot \odot \odot$	DB	0.85	0.80	0.65	0.55
$\odot \odot \odot \odot$	DBB	0.80	0.75	0.60	0.45
$\odot \odot \odot \odot \odot$	DBD	0.75	0.70	0.55	0.40

*Speed coefficients also vary depending on the distance of bearings.

1. Angular contact ball bearings

High Ability Ceramic bearings

3NCHAD000CA series

Contact angle 20°

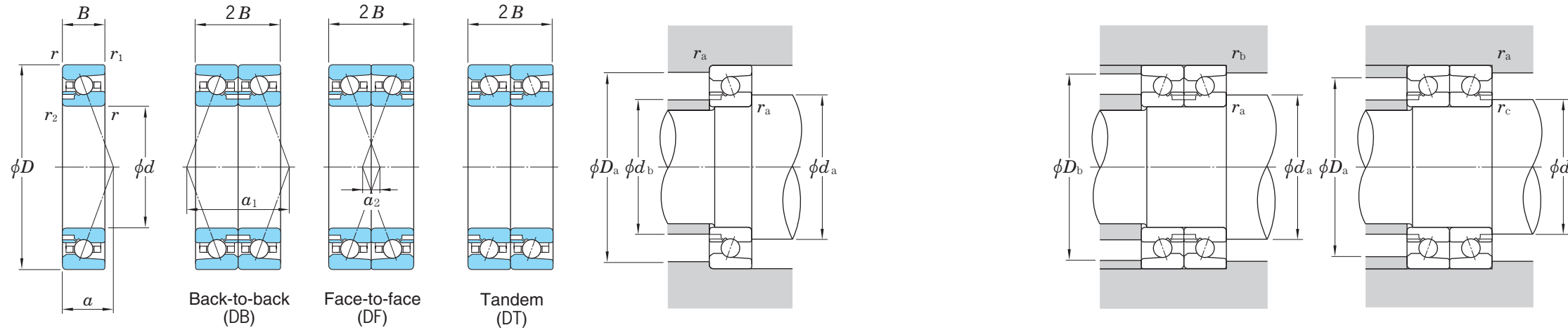

Static equivalent load $P_0 = X_0 F_r + Y_0 F_a$

Contact angle	Single row/Tandem		Back-to-back/Face-to-face	
	X_0	Y_0	X_0	Y_0
20°	0.5	0.42	1	0.84

Note that in the case of single row or tandem, assume $P_0 = F_r$ if $P_0 > F_r$.

Dynamic equivalent load $P = X F_r + Y F_a$

Contact angle	e	Single row/Tandem				Back-to-back/Face-to-face			
		$\frac{F_a}{F_r} \leq e$		$\frac{F_a}{F_r} > e$		$\frac{F_a}{F_r} \leq e$		$\frac{F_a}{F_r} > e$	
		X	Y	X	Y	X	Y	X	Y
20°	0.57	1	0	0.43	1	1	1.09	0.70	1.63

d	Boundary dimensions (mm)					Bearing No.	Basic load ratings (kN)		Limiting speeds (min ⁻¹) Oil lub.	Load center (mm) a	(Refer.) Mass (kg/row)	Permissible axial loads (kN) (static)	Load center spread of pair-mounted bearings (mm)		Mounting dimensions (mm)						Nut axial tension (N)	Interference of retaining plate (mm)	Bearing No.	
	D	B	r min.	r ₁ min.	r ₂ min.		C _r	C _{0r}					a ₁	a ₂	d _a min.	d _b min.	D _a max.	D _b max.	r _a max.	r _b max.				r _c max.
35	62	14	1	0.6	0.3	3NCHAD007CA	8.40	4.90	52 000	15.8	0.157	4.90	31.7	3.7	40.5	38.5	56.5	57.5	1	0.6	0.3	8 000	0.01~0.02	3NCHAD007CA
40	68	15	1	0.6	0.3	3NCHAD008CA	8.90	5.50	46 000	17.3	0.197	5.55	34.7	4.7	45.5	43.5	62.5	63.5	1	0.6	0.3	8 000	0.01~0.02	3NCHAD008CA
45	75	16	1	0.6	0.3	3NCHAD009CA	9.95	6.30	42 000	18.9	0.249	6.36	37.8	5.8	50.5	48.5	69.5	70.5	1	0.6	0.3	10 000	0.01~0.02	3NCHAD009CA
50	80	16	1	0.6	0.3	3NCHAD010CA	10.8	7.35	38 000	19.8	0.269	7.40	39.7	7.7	55.5	53.5	74.5	75.5	1	0.6	0.3	10 000	0.01~0.02	3NCHAD010CA
55	90	18	1.1	0.6	0.3	3NCHAD011CA	13.0	8.90	34 000	22.2	0.395	8.94	44.4	8.4	62	58.5	83	85.5	1	0.6	0.3	12 000	0.01~0.02	3NCHAD011CA
60	95	18	1.1	0.6	0.3	3NCHAD012CA	13.6	9.75	32 000	23.1	0.427	9.84	46.2	10.2	67	63.5	88	90.5	1	0.6	0.3	12 000	0.01~0.02	3NCHAD012CA
65	100	18	1.1	0.6	0.3	3NCHAD013CA	14.2	10.7	30 000	24.0	0.456	10.7	48.0	12.0	72	68.5	93	95.5	1	0.6	0.3	15 000	0.01~0.02	3NCHAD013CA
70	110	20	1.1	0.6	0.3	3NCHAD014CA	19.1	13.9	28 000	26.4	0.635	14.0	52.8	12.8	77	73.5	103	105.5	1	0.6	0.3	15 000	0.01~0.02	3NCHAD014CA
75	115	20	1.1	0.6	0.3	3NCHAD015CA	19.5	14.6	26 000	27.3	0.657	14.7	54.6	14.6	82	78.5	108	110.5	1	0.6	0.3	15 000	0.01~0.02	3NCHAD015CA
80	125	22	1.1	0.6	0.3	3NCHAD016CA	22.9	17.3	23 000	29.7	0.885	17.5	59.3	15.3	87	83.5	118	120.5	1	0.6	0.3	15 000	0.01~0.02	3NCHAD016CA
85	130	22	1.1	0.6	0.3	3NCHAD017CA	23.3	18.2	22 000	30.6	0.924	18.3	61.1	17.1	92	88.5	123	125.5	1	0.6	0.3	18 000	0.01~0.02	3NCHAD017CA
90	140	24	1.5	1	0.3	3NCHAD018CA	30.4	23.5	21 000	32.9	1.15	23.6	65.9	17.9	98.5	94	131.5	134.5	1.5	1	0.3	18 000	0.01~0.02	3NCHAD018CA
95	145	24	1.5	1	0.3	3NCHAD019CA	31.0	24.6	20 000	33.8	1.25	24.8	67.7	19.7	103.5	99	136.5	139.5	1.5	1	0.3	18 000	0.01~0.02	3NCHAD019CA
100	150	24	1.5	1	0.3	3NCHAD020CA	31.6	25.7	19 000	34.7	1.28	25.9	69.5	21.5	108.5	104	141.5	144.5	1.5	1	0.3	20 000	0.01~0.02	3NCHAD020CA
105	160	26	2	1	0.6	3NCHAD021CA	37.6	31.8	18 000	37.1	1.65	32.0	74.2	22.2	115	110	150	154.5	2	1	0.6	20 000	0.02~0.04	3NCHAD021CA
110	170	28	2	1	0.6	3NCHAD022CA	42.4	36.1	17 000	39.5	2.06	36.4	79.0	23.0	120	115	160	164.5	2	1	0.6	20 000	0.02~0.04	3NCHAD022CA
120	180	28	2	1	0.6	3NCHAD024CA	43.8	39.0	16 000	41.3	2.21	39.3	82.6	26.6	130	125	170	174.5	2	1	0.6	20 000	0.02~0.04	3NCHAD024CA
130	200	33	2	1	0.6	3NCHAD026CA	55.0	47.2	14 000	46.5	3.30	47.6	93.1	27.1	140	135	190	194.5	2	1	0.6	20 000	0.02~0.04	3NCHAD026CA

- [Remarks] 1. Boundary dimensions of this bearing are the same as those of the 7000 series.
 2. For the dimensions of the spacers for oil / air lubrication, refer to Table 9. 4(4) on page 40.
 3. For the discharge intervals of the oil / air, refer to Supplementary table 6 on page 219.

Basic load ratings in case of multiple-row combination bearing

	Basic dynamic load ratings	Basic static load ratings
2-row	$C_r \times 1.62$	$C_{0r} \times 2$
3-row	$C_r \times 2.16$	$C_{0r} \times 3$
4-row	$C_r \times 2.64$	$C_{0r} \times 4$

Speed coefficients in case of multiple-row combination bearing

Combination types	Combination symbols	Preload when mounting			
		Preload S	Preload L	Preload M	Preload H
⊘ ⊘	DB	0.85	0.80	0.65	0.55
⊘ ⊘ ⊘ ⊘	DBB	0.80	0.75	0.60	0.45
⊘ ⊘ ⊘	DBD	0.75	0.70	0.55	0.40

*Speed coefficients also vary depending on the distance of bearings.

These bearings are useful only with oil / air lubrication. Please use with lubricating spacers as shown below.

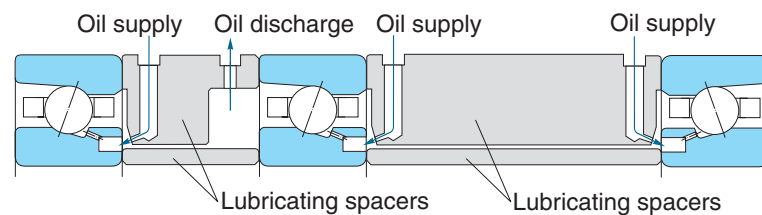

1. Angular contact ball bearings

High Ability Ceramic bearings

3NCHAF900CA series

Contact angle 20°

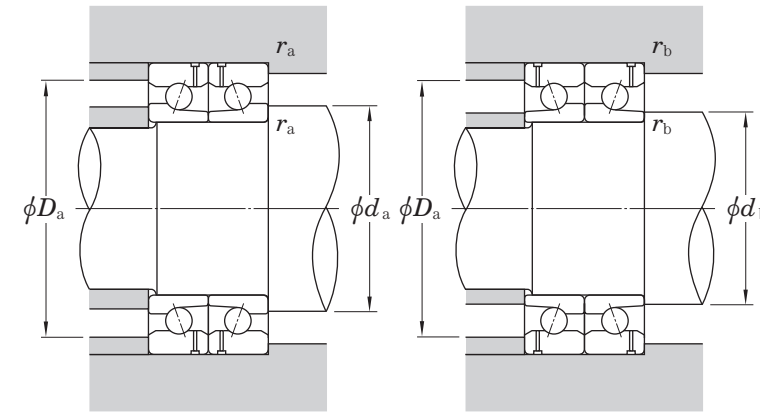
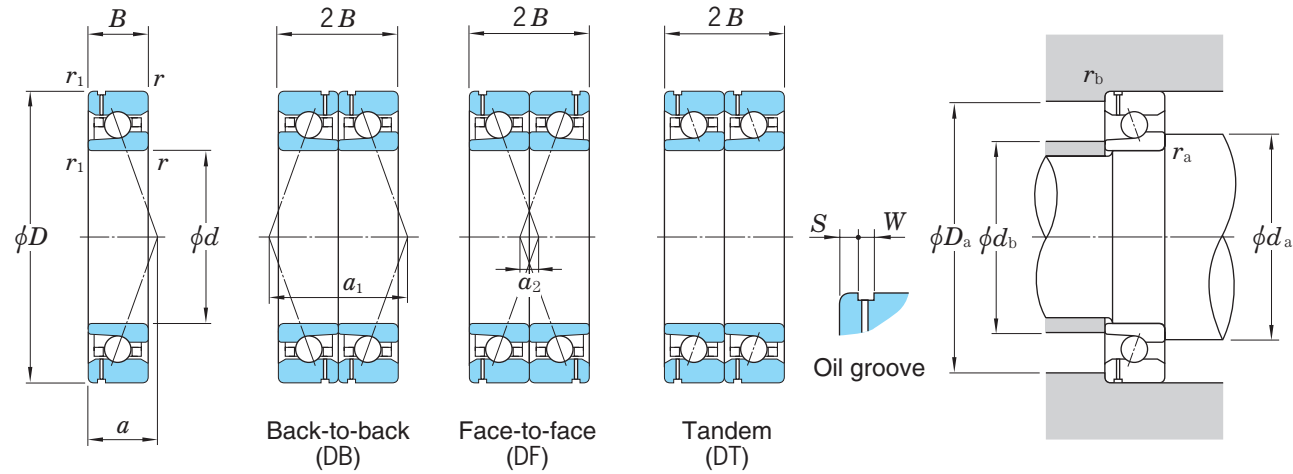

Static equivalent load $P_0 = X_0 F_r + Y_0 F_a$

Contact angle	Single row/Tandem		Back-to-back/Face-to-face	
	X_0	Y_0	X_0	Y_0
20°	0.5	0.42	1	0.84

Note that in the case of single row or tandem, assume $P_0 = F_r$ if $P_0 > F_r$.

Dynamic equivalent load $P = X F_r + Y F_a$

Contact angle	e	Single row/Tandem				Back-to-back/Face-to-face			
		$\frac{F_a}{F_r} \leq e$		$\frac{F_a}{F_r} > e$		$\frac{F_a}{F_r} \leq e$		$\frac{F_a}{F_r} > e$	
		X	Y	X	Y	X	Y	X	Y
20°	0.57	1	0	0.43	1	1	1.09	0.70	1.63

d	Boundary dimensions (mm)				Bearing No.	Basic load ratings (kN)		Limiting speeds (min ⁻¹) Oil lub.	Load center (mm) a	(Refer.) Mass (kg/row)	Permissible axial loads (kN) (static)	Load center spread of pair-mounted bearings (mm)		Oil groove dimensions (mm)		Mounting dimensions (mm)					Nut axial tension (N)	Interference of retaining plate (mm)	Bearing No.
	D	B	r min.	r ₁ min.		C _r	C _{0r}					a ₁	a ₂	S	W	d _a min.	d _b min.	D _a max.	r _a max.	r _b max.			
40	62	12	0.6	0.3	3NCHAF908CA	6.05	3.80	71 000	15.0	0.118	3.81	30.0	6.0	2.1	2.0	44.5	43	57.5	0.6	0.3	5 000	0.01~0.02	3NCHAF908CA
45	68	12	0.6	0.3	3NCHAF909CA	6.50	4.35	64 000	16.0	0.139	4.41	32.0	8.0	2.0	2.0	49.5	48	63.5	0.6	0.3	6 000	0.01~0.02	3NCHAF909CA
50	72	12	0.6	0.3	3NCHAF910CA	8.40	5.65	58 000	16.9	0.134	5.71	33.8	9.8	1.8	2.0	54.5	53	67.5	0.6	0.3	6 000	0.01~0.02	3NCHAF910CA
55	80	13	1	0.6	3NCHAF911CA	9.00	6.45	53 000	18.5	0.192	6.54	37.0	11.0	2.0	2.0	60.5	59.5	74.5	1	0.6	6 000	0.01~0.02	3NCHAF911CA
60	85	13	1	0.6	3NCHAF912CA	9.10	6.75	49 000	19.4	0.206	6.85	38.8	12.8	2.0	2.0	65.5	64.5	79.5	1	0.6	8 000	0.01~0.02	3NCHAF912CA
65	90	13	1	0.6	3NCHAF913CA	10.3	7.75	46 000	20.3	0.215	7.84	40.7	14.7	2.0	2.0	70.5	69	84.5	1	0.6	8 000	0.01~0.02	3NCHAF913CA
70	100	16	1	0.6	3NCHAF914CA	11.8	9.20	42 000	23.1	0.414	9.29	46.2	14.2	2.8	2.5	75.5	74.5	94.5	1	0.6	10 000	0.01~0.02	3NCHAF914CA
75	105	16	1	0.6	3NCHAF915CA	12.2	9.90	40 000	24.0	0.383	10.0	48.0	16.0	2.8	2.5	80.5	79.5	99.5	1	0.6	10 000	0.01~0.02	3NCHAF915CA
80	110	16	1	0.6	3NCHAF916CA	12.6	10.6	38 000	24.9	0.405	10.7	49.8	17.8	2.7	2.5	85.5	84.5	104.5	1	0.6	10 000	0.01~0.02	3NCHAF916CA
85	120	18	1.1	0.6	3NCHAF917CA	15.1	12.5	35 000	27.1	0.579	12.6	54.2	18.2	3.1	3.0	92	89.5	113	1	0.6	12 000	0.01~0.02	3NCHAF917CA
90	125	18	1.1	0.6	3NCHAF918CA	15.6	13.4	32 000	28.0	0.604	13.5	56.0	20.0	3.1	3.0	97	94.5	118	1	0.6	12 000	0.01~0.02	3NCHAF918CA
95	130	18	1.1	0.6	3NCHAF919CA	15.7	13.9	30 000	28.9	0.717	14.0	57.9	21.9	3.1	3.0	102	99.5	123	1	0.6	12 000	0.01~0.02	3NCHAF919CA
100	140	20	1.1	0.6	3NCHAF920CA	22.3	19.3	29 000	31.2	0.854	19.5	62.4	22.4	3.3	3.0	107	104.5	133	1	0.6	15 000	0.01~0.02	3NCHAF920CA
105	145	20	1.1	0.6	3NCHAF921CA	23.0	20.6	27 000	32.1	0.892	20.8	64.2	24.2	3.3	3.0	112	109.5	138	1	0.6	15 000	0.02~0.04	3NCHAF921CA
110	150	20	1.1	0.6	3NCHAF922CA	23.3	21.3	26 000	33.0	1.05	21.5	66.0	26.0	3.3	3.0	117	114.5	143	1	0.6	15 000	0.02~0.04	3NCHAF922CA
120	165	22	1.1	0.6	3NCHAF924CA	27.3	25.4	24 000	36.1	1.43	25.6	72.2	28.2	3.7	3.5	127	124.5	158	1	0.6	15 000	0.02~0.04	3NCHAF924CA
130	180	24	1.5	1	3NCHAF926CA	31.4	29.8	22 000	39.3	1.90	30.0	78.6	30.6	4.0	4.0	138.5	135.5	171.5	1.5	1	20 000	0.02~0.04	3NCHAF926CA

- [Remarks]
- Boundary dimensions of this bearing are the same as those of the 7900 series.
 - For the dimensions of the spacers for oil / air lubrication, refer to Table 9. 4(5) on page 40.
 - For the discharge intervals of the oil / air, refer to Supplementary table 6 on page 219.

Basic load ratings in case of multiple-row combination bearing

	Basic dynamic load ratings	Basic static load ratings
2-row	$C_r \times 1.62$	$C_{0r} \times 2$
3-row	$C_r \times 2.16$	$C_{0r} \times 3$
4-row	$C_r \times 2.64$	$C_{0r} \times 4$

Speed coefficients in case of multiple-row combination bearing

Combination types	Combination symbols	Preload when mounting			
		Preload S	Preload L	Preload M	Preload H
⊗ ⊗	DB	0.85	0.80	0.65	0.55
⊗ ⊗ ⊗	DBB	0.80	0.75	0.60	0.45
⊗ ⊗ ⊗	DBD	0.75	0.70	0.55	0.40

*Speed coefficients also vary depending on the distance of bearings.

These bearings are useful only with oil / air lubrication. Please use with lubricating spacers as shown below.

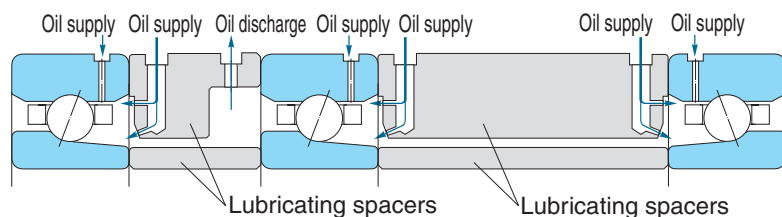

1. Angular contact ball bearings

High Ability Ceramic bearings

3NCHAFO00CA series

Contact angle 20°

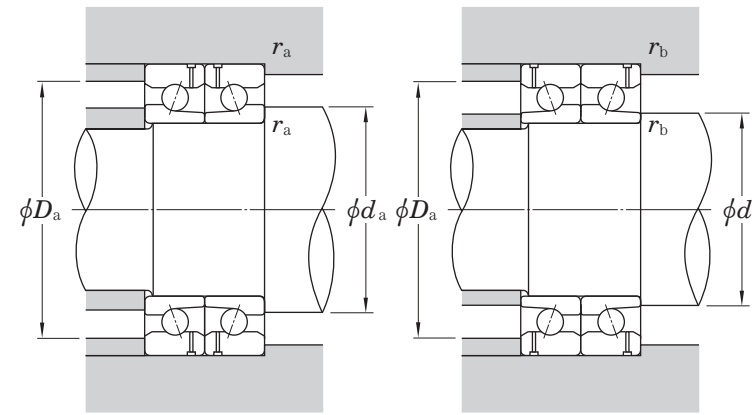
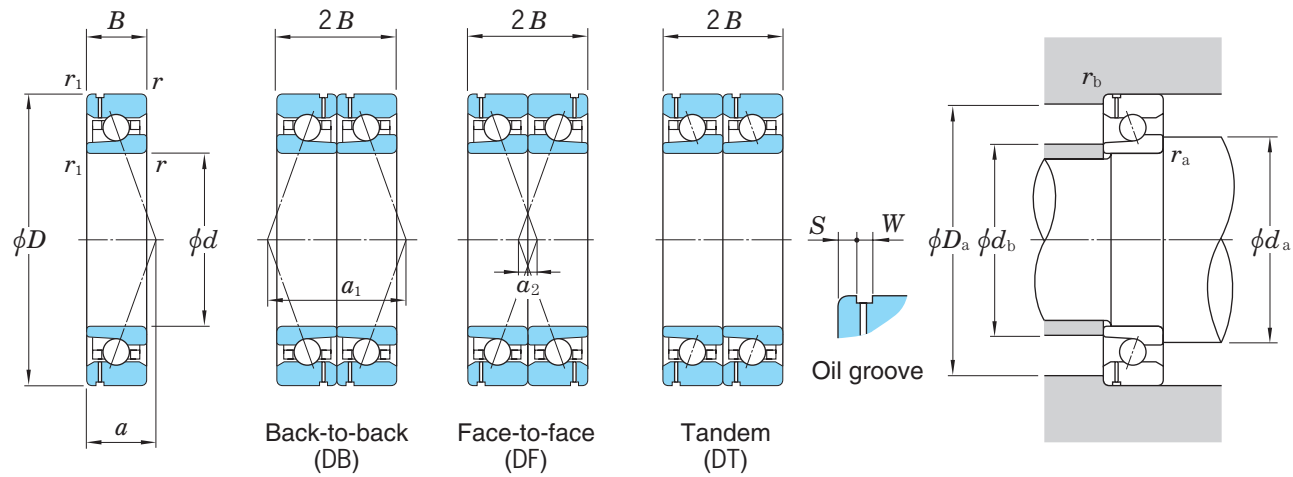

Static equivalent load $P_0 = X_0 F_r + Y_0 F_a$

Contact angle	Single row/Tandem		Back-to-back/Face-to-face	
	X_0	Y_0	X_0	Y_0
20°	0.5	0.42	1	0.84

Note that in the case of single row or tandem, assume $P_0 = F_r$ if $P_0 > F_r$.

Dynamic equivalent load $P = X F_r + Y F_a$

Contact angle	e	Single row/Tandem		Back-to-back/Face-to-face					
		$\frac{F_a}{F_r} \leq e$	$\frac{F_a}{F_r} > e$	$\frac{F_a}{F_r} \leq e$	$\frac{F_a}{F_r} > e$	X	Y		
20°	0.57	1	0	0.43	1	1	1.09	0.70	1.63

d	Boundary dimensions (mm)				Bearing No.	Basic load ratings (kN)		Limiting speeds (min ⁻¹) Oil lub.	Load center (mm) a	(Refer.) Mass (kg/row)	Permissible axial loads (kN) (static)	Load center spread of pair-mounted bearings (mm)		Oil groove dimensions (mm)		Mounting dimensions (mm)					Nut axial tension (N)	Interference of retaining plate (mm)	Bearing No.
	D	B	r _{min.}	r _{1 min.}		C _r	C _{0r}					a ₁	a ₂	S	W	d _{a min.}	d _{b min.}	D _{a max.}	r _{a max.}	r _{b max.}			
30	55	13	1	0.6	3NCHAFO06CA	7.55	3.95	85 000	14.0	0.117	3.95	27.9	1.9	2.2	2.0	35.5	34	49.5	1	0.6	5 000	0.01~0.02	3NCHAFO06CA
35	62	14	1	0.6	3NCHAFO07CA	8.15	4.60	74 000	15.6	0.158	4.60	31.1	3.1	2.4	2.5	40.5	39.5	56.5	1	0.6	8 000	0.01~0.02	3NCHAFO07CA
40	68	15	1	0.6	3NCHAFO08CA	8.65	5.20	67 000	17.0	0.199	5.24	33.9	3.9	2.8	2.5	45.5	44.5	62.5	1	0.6	8 000	0.01~0.02	3NCHAFO08CA
45	75	16	1	0.6	3NCHAFO09CA	10.0	6.30	60 000	18.6	0.255	6.33	37.1	5.1	2.9	2.5	50.5	49.5	69.5	1	0.6	10 000	0.01~0.02	3NCHAFO09CA
50	80	16	1	0.6	3NCHAFO10CA	10.5	7.00	56 000	19.5	0.276	7.05	38.9	6.9	2.9	2.5	55.5	54.5	74.5	1	0.6	10 000	0.01~0.02	3NCHAFO10CA
55	90	18	1.1	0.6	3NCHAFO11CA	12.6	8.45	50 000	21.7	0.407	8.49	43.5	7.5	3.4	3.0	62	59.5	83	1	0.6	12 000	0.01~0.02	3NCHAFO11CA
60	95	18	1.1	0.6	3NCHAFO12CA	13.3	9.30	47 000	22.6	0.435	9.39	45.3	9.3	3.4	3.0	67	64.5	88	1	0.6	12 000	0.01~0.02	3NCHAFO12CA
65	100	18	1.1	0.6	3NCHAFO13CA	13.9	10.2	44 000	23.6	0.466	10.3	47.1	11.1	3.4	3.0	72	69.5	93	1	0.6	15 000	0.01~0.02	3NCHAFO13CA
70	110	20	1.1	0.6	3NCHAFO14CA	18.7	13.2	40 000	25.8	0.728	13.3	51.7	11.7	3.4	3.0	77	74.5	103	1	0.6	15 000	0.01~0.02	3NCHAFO14CA
75	115	20	1.1	0.6	3NCHAFO15CA	19.1	13.9	38 000	26.7	0.673	14.0	53.5	13.5	3.4	3.0	82	79.5	108	1	0.6	15 000	0.01~0.02	3NCHAFO15CA
80	125	22	1.1	0.6	3NCHAFO16CA	22.4	16.5	35 000	29.0	0.906	16.6	58.0	14.0	3.8	3.5	87	84.5	118	1	0.6	15 000	0.01~0.02	3NCHAFO16CA
85	130	22	1.1	0.6	3NCHAFO17CA	22.8	17.4	32 000	29.9	0.950	17.5	59.9	15.9	3.8	3.5	92	89.5	123	1	0.6	18 000	0.01~0.02	3NCHAFO17CA
90	140	24	1.5	1	3NCHAFO18CA	28.8	21.4	30 000	32.2	1.21	21.6	64.4	16.4	3.8	4.0	98.5	95.5	131.5	1.5	1	18 000	0.01~0.02	3NCHAFO18CA
95	145	24	1.5	1	3NCHAFO19CA	29.5	22.5	29 000	33.1	1.45	22.7	66.2	18.2	3.8	4.0	103.5	100.5	136.5	1.5	1	18 000	0.01~0.02	3NCHAFO19CA
100	150	24	1.5	1	3NCHAFO20CA	30.1	23.6	27 000	34.0	1.32	23.8	68.0	20.0	3.8	4.0	108.5	105.5	141.5	1.5	1	20 000	0.01~0.02	3NCHAFO20CA
105	160	26	2	1	3NCHAFO21CA	34.2	27.1	26 000	36.3	1.67	27.3	72.6	20.6	4.1	5.0	115	110.5	150	2	1	20 000	0.02~0.04	3NCHAFO21CA
110	170	28	2	1	3NCHAFO22CA	37.4	29.5	25 000	38.6	2.38	29.7	77.1	21.1	4.6	5.0	120	115.5	160	2	1	20 000	0.02~0.04	3NCHAFO22CA

- [Remarks] 1. Boundary dimensions of this bearing are the same as those of the 7000 series.
 2. For the dimensions of the spacers for oil / air lubrication, refer to Table 9. 4(5) on page 40.
 3. For the discharge intervals of the oil / air, refer to Supplementary table 6 on page 219.

Basic load ratings in case of multiple-row combination bearing

	Basic dynamic load ratings	Basic static load ratings
2-row	$C_r \times 1.62$	$C_{0r} \times 2$
3-row	$C_r \times 2.16$	$C_{0r} \times 3$
4-row	$C_r \times 2.64$	$C_{0r} \times 4$

Speed coefficients in case of multiple-row combination bearing

Combination types	Combination symbols	Preload when mounting			
		Preload S	Preload L	Preload M	Preload H
⊗ ⊗	DB	0.85	0.80	0.65	0.55
⊗ ⊗ ⊗ ⊗	DBB	0.80	0.75	0.60	0.45
⊗ ⊗ ⊗ ⊗ ⊗ ⊗	DBD	0.75	0.70	0.55	0.40

*Speed coefficients also vary depending on the distance of bearings.

These bearings are useful only with oil / air lubrication. Please use with lubricating spacers as shown below.

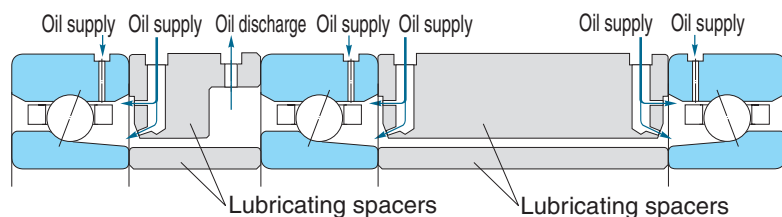

2. Cylindrical Roller Bearings

Contents

	Page
2. 1 Types and features of cylindrical roller bearings	123
2. 2 Composition of bearing numbers	123
2. 3 Tolerance of cylindrical roller bearings.....	124
2. 4 Radial internal clearances of cylindrical roller bearings	125
 ■ Bearing dimension tables	
· NN3000(K) series	126
· NNU4900(K) series.....	128
· N1000(K) series	130
· 3NCN1000(K) series.....	132



2. Cylindrical roller bearings

The cylindrical roller bearing has high radial rigidity and is suitable for high-speed rotation through an arrangement of many rollers and a line contact which is made between the rollers and raceways.

The bores of cylindrical roller bearings are either cylindrical or tapered. With a bearing having a tapered bore, its radial internal clearance can be set with ease to a given value by adjusting the extent to which the bearing is pushed onto the shaft.

2.1 Types and features of cylindrical roller bearings

The cylindrical roller bearing is divided into two types: double row and single row bearings. Both having outer ring which is separable from the inner to facilitate mounting and dismounting from shaft and housing (see Fig. 2. 1).

1) Double row cylindrical roller bearings

The double row cylindrical roller bearing is classified into the NN30 and NNU49 series.

Some of these bearings have a lubrication groove and holes provided at the center of the outside surface of the outer rings in order to attain a sufficient supply of lubricant to the inside of the bearing (the suffix W is added).

2) Single row cylindrical roller bearings

Single row cylindrical roller bearings for the spindles of machine tools are often selected from the N10 series.

The bore and outside diameters of the N10 series are the same as those of the NN30: double row cylindrical roller bearing series.

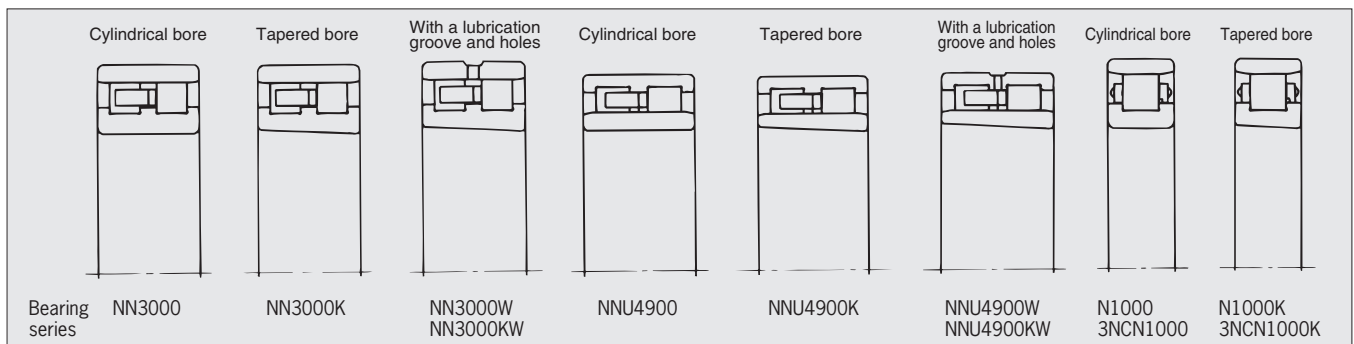
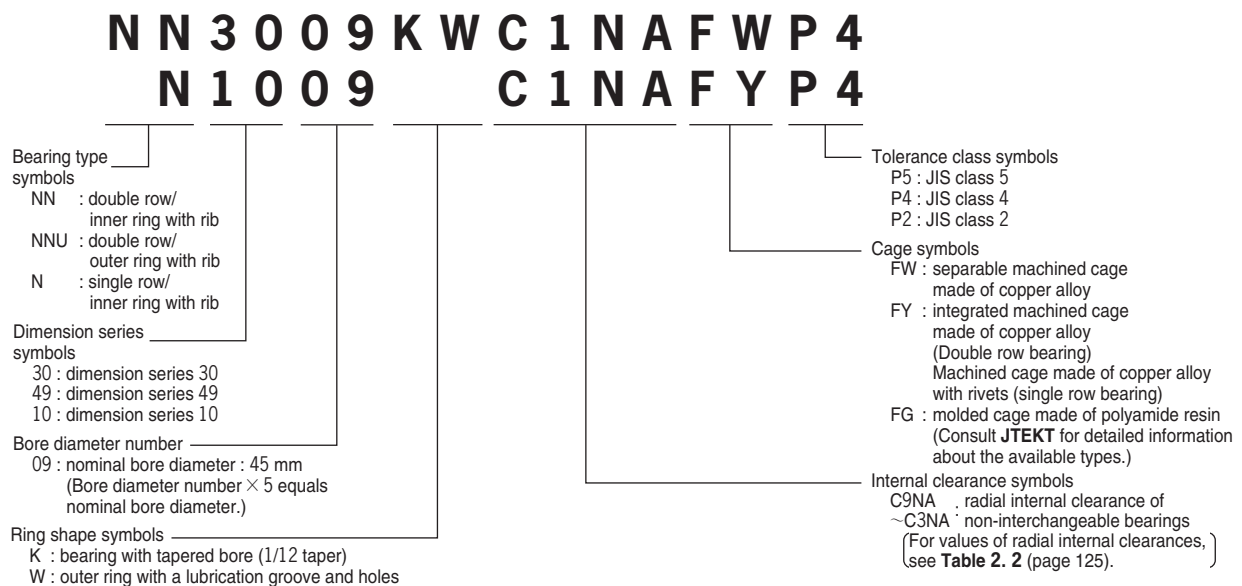

Fig. 2. 1 Types and series of cylindrical roller bearings for machine tool spindles

2.2 Composition of bearing numbers (cylindrical roller bearings)



For ceramic bearings



2.3 Tolerance of cylindrical roller bearings

1) Boundary dimension and running accuracies

The tolerance of precision cylindrical roller bearings is compliant with permissible dimensional deviations and limits of classes 5, 4, and 2 as specified in JIS B 1514 for radial bearings (tapered roller bearings not included).

Permissible dimensional deviations and limits to boundary dimension and running accuracies are shown in Table 1. 2 on page 56.

2) Permissible dimensional deviations and limits for tapered bores

The dimensional deviations and limits for tapered bores of radial bearings of class 0 only are specified in JIS B 1514.

JTEKT has formulated special standards for dimensional deviations and limits for tapered bores of radial bearings of classes 5, 4, and 2 (see Table 2. 1).

Table 2. 1 Dimensional deviations and limits for tapered bores of radial bearings (classes 5, 4, and 2)

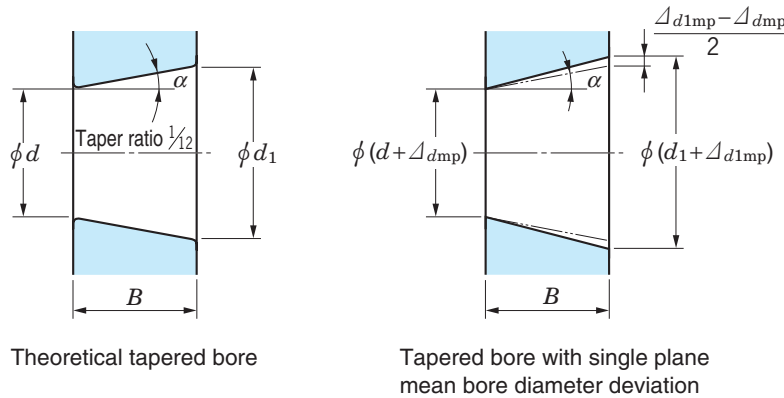

Unit : μm

Nominal bore diameter <i>d</i> (mm)		Δ_{dmp}				$\Delta_{d1mp} - \Delta_{dmp}^{1)}$		$V_{dsp}^{2)}$				
		Class 5		Classes 4, 2				Class 5		Class 4		Class 2
over	up to	upper	lower	upper	lower	upper	lower	max.		max.		max.
18	30	+10	0	+ 6	0	+ 3	0	6	5	5	4	2.5
30	50	+12	0	+ 8	0	+ 3	0	8	6	6	5	2.5
50	80	+15	0	+ 9	0	+ 5	0	9	7	7	5	4
80	120	+20	0	+10	0	+ 6	0	10	8	8	6	5
120	180	+25	0	+13	0	+ 8	0	13	10	10	8	7
180	250	+30	0	+15	0	+ 9	0	15	12	12	9	8
250	315	+35	0	+18	0	+10	0	18	15	14	11	—
315	400	+40	0	+23	0	+12	0	23	18	18	14	—

[Notes] 1) Permissible dimensional deviation for the taper angle is $4^{\circ}46'18.8''^{+26''}_0$

2) Applied to all radial planes of tapered bores.

[Remarks] 1. **Scope** These values are applied to the tapered bores with a reference taper ratio of 1/12.

2. **Symbols for quantities** d_1 : reference diameter at theoretical large end of tapered bore $d_1 = d + \frac{1}{12}B$

Δ_{dmp} : single plane mean bore diameter deviation at theoretical small end of tapered bore

Δ_{d1mp} : single plane mean bore diameter deviation at theoretical large end of tapered bore

V_{dsp} : single plane bore diameter variation

B : nominal inner ring width

α : $\frac{1}{2}$ of the nominal taper angle of tapered bore

$\alpha = 2^{\circ}23'9.4''$

$= 2.38594^{\circ}$

$= 0.041643 \text{ rad}$

2.4 Radial internal clearances of cylindrical roller bearings

In order to minimize variations in the running accuracy of machine tool spindles, the values of the radial internal clearance should be same as those of special radial internal clearance of non-interchangeable bearings.

Table 2. 2 shows values of non-interchangeable radial internal clearances for cylindrical roller bearings.

Since the inner and outer rings of cylindrical roller bearings for spindles of machine tools are not interchangeable, care should be taken when using them.

Table 2. 2 Values of radial internal clearances for cylindrical roller bearings

(1) Bearings with cylindrical bores

Unit : μm

Nominal bore diameter <i>d</i> (mm)		Values of non-interchangeable clearances of bearings with cylindrical bores							
		C1NA		C2NA		CNNA		C3NA	
over	up to	min.	max.	min.	max.	min.	max.	min.	max.
24	30	5	10	10	25	25	35	40	50
30	40	5	12	12	25	25	40	45	55
40	50	5	15	15	30	30	45	50	65
50	65	5	15	15	35	35	50	55	75
65	80	10	20	20	40	40	60	70	90
80	100	10	25	25	45	45	70	80	105
100	120	10	25	25	50	50	80	95	120
120	140	15	30	30	60	60	90	105	135
140	160	15	35	35	65	65	100	115	150
160	180	15	35	35	75	75	110	125	165
180	200	20	40	40	80	80	120	140	180
200	225	20	45	45	90	90	135	155	200
225	250	25	50	50	100	100	150	170	215
250	280	25	55	55	110	110	165	185	240
280	315	30	60	60	120	120	180	205	265
315	355	30	65	65	135	135	200	225	295
355	400	35	75	75	150	150	225	255	330

(2) Bearings with tapered bores

Unit : μm

Nominal bore diameter <i>d</i> (mm)		Values of non-interchangeable clearances of bearings with tapered bores											
		C9NA ¹⁾		C0NA		C1NA		C2NA		CNNA		C3NA	
over	up to	min.	max.	min.	max.	min.	max.	min.	max.	min.	max.	min.	max.
24	30	5	10	10	20	10	25	25	35	40	50	50	60
30	40	5	12	10	20	12	25	25	40	45	55	55	70
40	50	5	15	10	20	15	30	30	45	50	65	65	80
50	65	5	15	10	20	15	35	35	50	55	75	75	90
65	80	10	20	15	30	20	40	40	60	70	90	90	110
80	100	10	25	20	35	25	45	45	70	80	105	105	125
100	120	10	25	20	35	25	50	50	80	95	120	120	145
120	140	15	30	25	40	30	60	60	90	105	135	135	160
140	160	15	35	30	45	35	65	65	100	115	150	150	180
160	180	15	35	30	45	35	75	75	110	125	165	165	200
180	200	20	40	30	50	40	80	80	120	140	180	180	220
200	225	20	45	35	55	45	90	90	135	155	200	200	240
225	250	25	50	40	65	50	100	100	150	170	215	215	265
250	280	25	55	40	65	55	110	110	165	185	240	240	295
280	315	30	60	45	75	60	120	120	180	205	265	265	325
315	355	30	65	45	75	65	135	135	200	225	295	295	360
355	400	35	75	50	90	75	150	150	225	255	330	330	405

[Note] 1) The clearance C9NA is applied to cylindrical roller bearings with tapered bores made to JIS tolerance classes 5 and 4.

2. Cylindrical roller bearings

NN3000(K) series

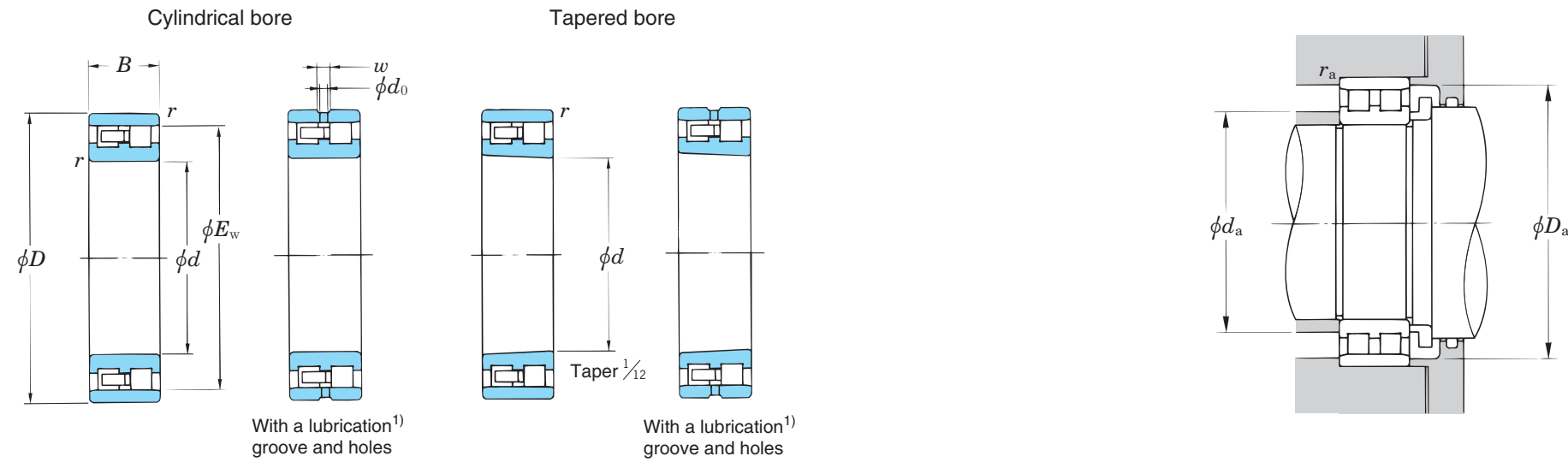

Dynamic equivalent load $P_r = F_r$
 Static equivalent load $P_{0r} = F_r$

Boundary dimensions (mm)					Bearing No. ¹⁾		Basic load ratings (kN)		Limiting speeds (min ⁻¹)		Dimensions of lubrication groove and holes (mm)		Mounting dimensions (mm)				Interspace volume (cm ³)	(Refer.) Mass (kg)	
d	D	B	$r_{min.}$	E_w	Cylindrical bore	Tapered bore	C_r	C_{0r}	Grease lub.	Oil lub.	d_0	w	d_a min.	D_a max.	D_a min.	r_a max.		Cylindrical bore	Tapered bore
25	47	16	0.6	41.3	NN3005	NN3005K	25.7	30.0	19 000	23 000	2	4	29	43	42	0.6	3.5	0.127	0.123
30	55	19	1	48.5	NN3006	NN3006K	36.8	44.1	16 000	20 000	2	4	35	50	49	1	6.0	0.198	0.192
35	62	20	1	55	NN3007	NN3007K	39.1	50.0	14 000	17 000	2	4	40	57	56	1	8.0	0.253	0.246
40	68	21	1	61	NN3008	NN3008K	41.3	55.9	13 000	15 000	2	4	45	63	62	1	10	0.307	0.298
45	75	23	1	67.5	NN3009	NN3009K	53.4	71.9	12 000	14 000	3	6	50	70	69	1	13	0.404	0.382
50	80	23	1	72.5	NN3010	NN3010K	52.8	72.6	11 000	13 000	3	6	55	75	74	1	14	0.429	0.415
55	90	26	1.1	81	NN3011	NN3011K	71.2	101	9 600	12 000	3	6	61.5	83.5	82	1	20	0.637	0.618
60	95	26	1.1	86.1	NN3012	NN3012K	72.8	106	9 000	11 000	3	6	66.5	88.5	87	1	22	0.685	0.664
65	100	26	1.1	91	NN3013	NN3013K	74.5	111	8 400	10 000	3	6	71.5	93.5	92	1	23	0.728	0.705
70	110	30	1.1	100	NN3014	NN3014K	96.9	148	7 600	9 200	3	6	76.5	103.5	101	1	33	1.04	1.02
75	115	30	1.1	105	NN3015	NN3015K	99.0	155	7 200	8 700	3	6	81.5	108.5	106	1	35	1.11	1.08
80	125	34	1.1	113	NN3016	NN3016K	119	186	6 700	8 100	4	7	86.5	118.5	114	1	48	1.55	1.50
85	130	34	1.1	118	NN3017	NN3017K	121	194	6 400	7 700	4	7	91.5	123.5	119	1	50	1.63	1.58
90	140	37	1.5	127	NN3018	NN3018K	142	228	5 900	7 100	4	7	98	132	129	1.5	65	2.07	2.01
95	145	37	1.5	132	NN3019	NN3019K	150	246	5 700	6 800	4	7	103	137	134	1.5	67	2.17	2.10
100	150	37	1.5	137	NN3020	NN3020K	153	256	5 500	6 500	4	7	108	142	139	1.5	68	2.28	2.21
105	160	41	2	146	NN3021	NN3021K	197	322	5 200	6 200	4	7	114	151	148	2	94	2.88	2.81
110	170	45	2	155	NN3022	NN3022K	221	361	4 800	5 800	4	7	119	161	157	2	117	3.65	3.56
120	180	46	2	165	NN3024	NN3024K	232	392	4 500	5 400	4	7	129	171	167	2	127	4.00	3.87
130	200	52	2	182	NN3026	NN3026K	283	476	4 100	4 900	5	8.5	139	191	183	2	185	5.94	5.76
140	210	53	2	192	NN3028	NN3028K	297	516	3 800	4 600	6	10	149	201	194	2	193	6.41	6.21
150	225	56	2.1	206	NN3030	NN3030K	334	587	3 500	4 200	6	10	161	214	208	2	239	7.74	7.50
160	240	60	2.1	219	NN3032	NN3032K	398	695	3 300	4 000	6	10	171	229	221	2	281	9.38	9.08
170	260	67	2.1	236	NN3034	NN3034K	471	824	3 000	3 600	6	10	181	249	238	2	371	12.8	12.4
180	280	74	2.1	255	NN3036	NN3036K	561	958	2 800	3 300	8	14	191	269	257	2	468	16.8	16.3
190	290	75	2.1	265	NN3038	NN3038K	598	1 020	2 700	3 200	8	14	201	279	267	2	494	17.6	17.1
200	310	82	2.1	282	NN3040	NN3040K	638	1 120	2 400	2 900	8	14	211	299	285	2	636	22.5	21.8
220	340	90	3	310	NN3044	NN3044K	752	1 370	2 200	2 600	8	14	233	327	313	2.5	859	29.3	28.4
240	360	92	3	330	NN3048	NN3048K	864	1 590	2 000	2 400	10	17	253	347	333	2.5	954	32.8	31.8
260	400	104	4	364	NN3052	NN3052K	1 030	1 830	1 800	2 200	10	17	276	384	367	3	1 340	47.4	46.0
280	420	106	4	384	NN3056	NN3056K	1 090	2 010	1 700	2 000	10	17	296	404	387	3	1 470	51.2	49.6
300	460	118	4	418	NN3060	NN3060K	1 290	2 460	1 500	1 800	10	17	316	444	421	3	1 960	70.8	68.7
320	480	121	4	438	NN3064	NN3064K	1 350	2 670	1 400	1 700	10	17	336	464	442	3	2 160	76.4	74.0
340	520	133	5	473	NN3068	NN3068K	1 580	3 090	1 200	1 500	12	20	360	500	477	4	2 890	101	97.8
360	540	134	5	493	NN3072	NN3072K	1 560	3 090	1 200	1 400	12	20	380	520	497	4	3 530	107	104
380	560	135	5	510	NN3076	NN3076K	1 650	3 350	1 100	1 300	12	20	400	540	514	4	3 270	113	109
400	600	148	5	548	NN3080	NN3080K	2 030	4 140	990	1 200	12	20	420	580	552	4	4 150	146	141

[Note] 1) The symbol W is added to the end of bearing numbers to denote bearings whose outer ring has a lubrication groove and holes.

[Remarks] 1. For the dimensions of the spacers for oil / air lubrication, refer to Table 9. 4(6) on page 41.
 2. For the discharge intervals of the oil / air, refer to Supplementary table 6 on page 219.

2. Cylindrical roller bearings

NNU4900(K) series

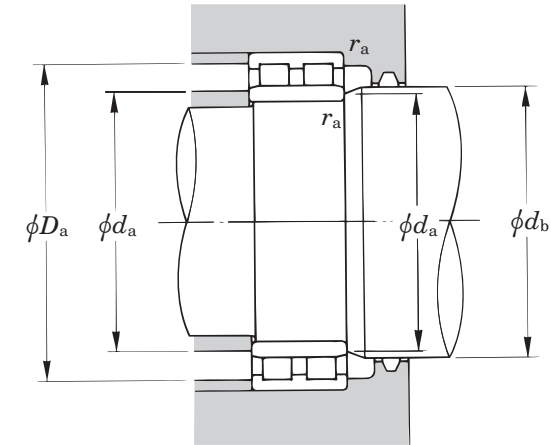
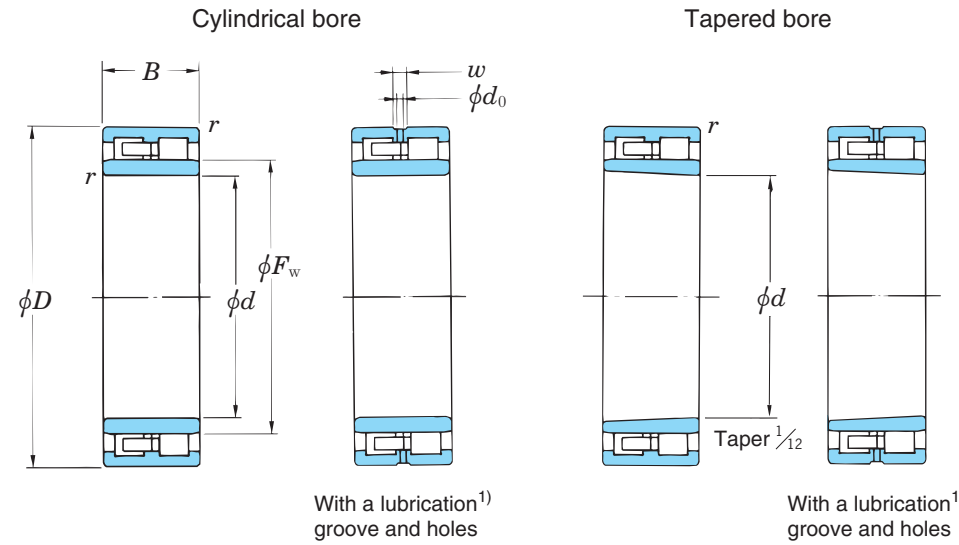

Dynamic equivalent load $P_r = F_r$
 Static equivalent load $P_{0r} = F_r$

Boundary dimensions (mm)					Bearing No. ¹⁾		Basic load ratings (kN)		Limiting speeds (min ⁻¹)		Dimensions of lubrication groove and holes (mm)		Mounting dimensions (mm)					Interspace volume (cm ³)	(Refer.) Mass (kg)	
d	D	B	r min.	F _w	Cylindrical bore	Tapered bore	C _r	C _{0r}	Grease lub.	Oil lub.	d ₀	w	d _a min.	d _a max.	d _b min.	D _a max.	r _a max.		Cylindrical bore	Tapered bore
100	140	40	1.1	113	NNU4920	NNU4920K	139	258	5 600	6 800	4	7	106.5	111	115	133.5	1	61	1.95	1.87
105	145	40	1.1	118	NNU4921	NNU4921K	157	306	5 400	6 500	4	7	111.5	116	120	138.5	1	61	2.00	1.91
110	150	40	1.1	123	NNU4922	NNU4922K	163	326	5 200	6 200	4	7	116.5	121	125	143.5	1	60	2.10	2.01
120	165	45	1.1	134.5	NNU4924	NNU4924K	187	373	4 700	5 700	4	7	126.5	132	137	158.5	1	84	2.90	2.77
130	180	50	1.5	146	NNU4926	NNU4926K	216	428	4 300	5 200	5	8.5	138	143.5	148	172	1.5	116	3.90	3.73
140	190	50	1.5	156	NNU4928	NNU4928K	222	456	4 000	4 800	6	10	148	153.5	158	182	1.5	125	4.15	3.97
150	210	60	2	168.5	NNU4930	NNU4930K	343	692	3 700	4 400	6	10	159	166	171	201	2	192	6.50	6.22
160	220	60	2	178.5	NNU4932	NNU4932K	340	695	3 400	4 100	6	10	169	176	182	211	2	186	6.95	6.65
170	230	60	2	188.5	NNU4934	NNU4934K	361	763	3 200	3 900	6	10	179	186	192	221	2	216	7.20	6.88
180	250	69	2	202	NNU4936	NNU4936K	458	964	3 000	3 600	8	14	189	199.5	205	241	2	297	10.5	10.1
190	260	69	2	210	NNU4938	NNU4938K	465	996	2 900	3 400	8	14	199	207	215	251	2	313	11.0	10.5
200	280	80	2.1	223	NNU4940	NNU4940K	509	1 050	2 600	3 200	8	14	211	219.5	228	269	2	469	15.4	14.7
220	300	80	2.1	244	NNU4944	NNU4944K	561	1 220	2 400	2 900	8	14	231	241	248	289	2	493	16.7	16.0
240	320	80	2.1	263	NNU4948	NNU4948K	588	1 340	2 200	2 600	10	17	251	260	269	309	2	527	18.0	17.2
260	360	100	2.1	287	NNU4952	NNU4952K	941	2 050	1 900	2 300	10	17	271	284	296	349	2	873	31.4	30.0
280	380	100	2.1	308	NNU4956	NNU4956K	976	2 200	1 800	2 100	10	17	291	305	316	369	2	982	33.1	31.6
300	420	118	3	339	NNU4960	NNU4960K	1 170	2 720	1 600	1 900	10	17	313	335	343	407	2.5	1 430	51.9	49.7
320	440	118	3	352	NNU4964	NNU4964K	1 220	2 750	1 500	1 800	10	17	333	348	363	427	2.5	1 630	53.7	51.4
340	460	118	3	372	NNU4968	NNU4968K	1 270	2 930	1 400	1 700	12	20	353	368	383	447	2.5	1 690	56.8	54.3

[Note] 1) The symbol W is added to the end of bearing numbers to denote bearings whose outer ring has a lubrication groove and holes.

N1000(K) series

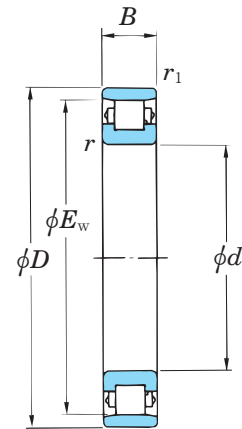

Cylindrical bore

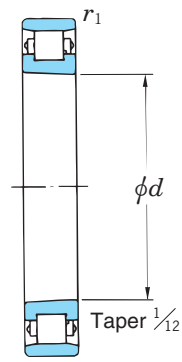

Tapered bore

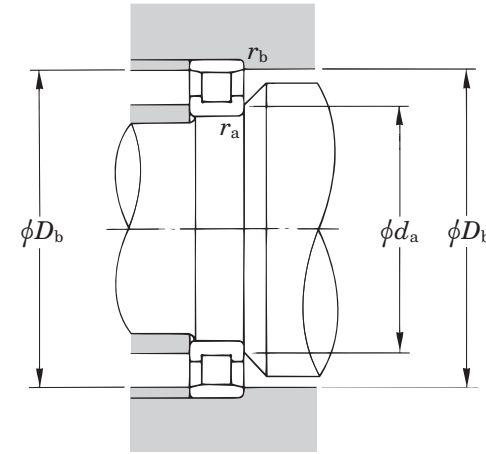

Dynamic equivalent load $P_r = F_r$
 Static equivalent load $P_{0r} = F_r$

Boundary dimensions (mm)						Bearing No.		Basic load ratings (kN)		Limiting speeds (min ⁻¹)		Mounting dimensions (mm)					Interspace volume (cm ³)	(Refer.) Mass (kg)		
d	D	B	r min.	r ₁ min.	E _w	Cylindrical bore	Tapered bore	C _r	C _{0r}	Grease lub.	Oil lub.	d _a min.	d _a max.	D _b	r _a min.	r _a max.		r _b min.	r _b max.	Cylindrical bore
30	55	13	1	0.6	48.5	N1006	N1006K	18.7	18.4	18 000	21 000	35	50	49.5	1	0.6	4.8	0.138	0.135	
35	62	14	1	0.6	55.0	N1007	N1007K	20.2	21.3	15 000	18 000	40	57	56	1	0.6	6.4	0.176	0.173	
40	68	15	1	0.6	61.0	N1008	N1008K	22.4	25.4	14 000	16 000	45	63	62	1	0.6	8.3	0.215	0.210	
45	75	16	1	0.6	68.5	N1009	N1009K	32.5	34.2	13 000	15 000	50	70	68.5	1	0.6	11	0.268	0.262	
50	80	16	1	0.6	72.5	N1010	N1010K	35.2	38.9	11 000	13 000	55	75	73.5	1	0.6	12	0.292	0.285	
55	90	18	1.1	1	81.0	N1011	N1011K	37.4	43.9	10 000	12 000	61.5	83.5	82	1	1	17	0.429	0.420	
60	95	18	1.1	1	86.1	N1012	N1012K	38.4	46.4	9 600	11 000	66.5	88.5	87	1	1	18	0.458	0.448	
65	100	18	1.1	1	91.5	N1013	N1013K	40.8	51.2	9 000	11 000	71.5	93.5	92	1	1	20	0.486	0.475	
70	110	20	1.1	1	100	N1014	N1014K	57.9	70.4	8 300	9 700	76.5	103.5	101	1	1	27	0.676	0.662	
75	115	20	1.1	1	106	N1015	N1015K	59.5	74.5	7 800	9 100	81.5	108.5	106	1	1	29	0.711	0.696	
80	125	22	1.1	1	113	N1016	N1016K	63.1	82.2	7 200	8 500	86.5	118.5	114	1	1	36	0.957	0.937	
85	130	22	1.1	1	118	N1017	N1017K	64.8	86.2	6 900	8 100	91.5	123	119	1	1	39	1.01	0.989	
90	140	24	1.5	1.1	129	N1018	N1018K	96.2	122	6 400	7 500	98	132	129	1.5	1	52	1.30	1.27	
95	145	24	1.5	1.1	133	N1019	N1019K	99.2	129	6 200	7 200	103	137	134	1.5	1	53	1.36	1.34	
100	150	24	1.5	1.1	139	N1020	N1020K	98.6	129	5 900	6 900	108	142	139	1.5	1	56	1.42	1.39	
105	160	26	2	1.1	146	N1021	N1021K	108	149	5 500	6 500	114	151	148	2	1	66	1.82	1.78	
110	170	28	2	1.1	157	N1022	N1022K	134	171	5 200	6 100	119	161	157	2	1	84	2.24	2.20	
120	180	28	2	1.1	167	N1024	N1024K	137	181	4 800	5 700	129	171	167	2	1	92	2.40	2.35	
130	200	33	2	1.1	182	N1026	N1026K	171	238	4 400	5 100	139	191	184	2	1	135	3.64	3.57	
140	210	33	2	1.1	192	N1028	N1028K	175	250	4 100	4 800	149	201	194	2	1	140	3.88	3.80	
150	225	35	2.1	1.5	207.5	N1030	N1030K	201	281	3 800	4 400	161	214	208	2	1.5	177	4.68	4.58	
160	240	38	2.1	1.5	219	N1032	N1032K	236	330	3 500	4 100	171	229	221	2	1.5	191	5.80	5.68	

[Remarks] 1. For the dimensions of the spacers for oil / air lubrication, refer to **Table 9. 4(6)** on page 41.
 2. For the discharge intervals of the oil / air, refer to **Supplementary table 6** on page 219.

3NCN1000(K) series Ceramic bearings

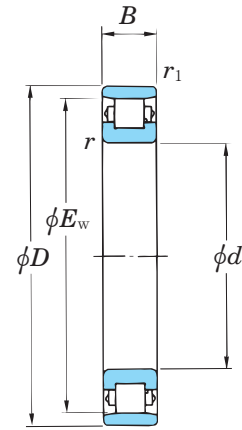

Cylindrical bore

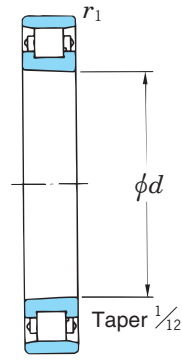

Tapered bore

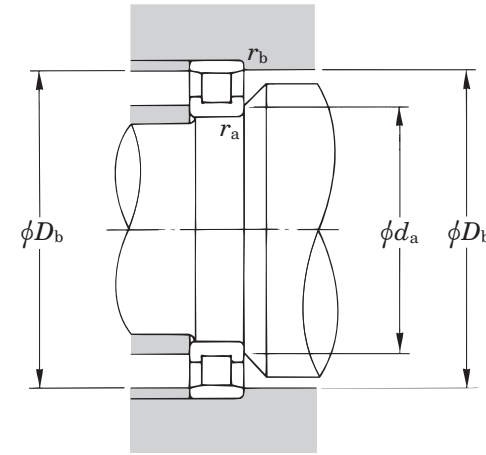

Dynamic equivalent load $P_r = F_r$
 Static equivalent load $P_{0r} = F_r$

Boundary dimensions (mm)						Bearing No.		Basic load ratings (kN)		Limiting speeds (min ⁻¹)		Mounting dimensions (mm)					Interspace volume (cm ³)	(Refer.) Mass (kg)	
d	D	B	r _{min.}	r _{1 min.}	E _w	Cylindrical bore	Tapered bore	C _r	C _{0r}	Grease lub.	Oil lub.	d _{a min.}	D _{b max.}	D _{b min.}	r _{a max.}	r _{b max.}		Cylindrical bore	Tapered bore
30	55	13	1	0.6	48.5	3NCN1006	3NCN1006K	18.7	18.4	23 000	27 000	35	50	49.5	1	0.6	4.8	0.126	0.123
35	62	14	1	0.6	55.0	3NCN1007	3NCN1007K	20.2	21.3	20 000	23 000	40	57	56	1	0.6	6.4	0.163	0.160
40	68	15	1	0.6	61.0	3NCN1008	3NCN1008K	22.4	25.4	18 000	21 000	45	63	62	1	0.6	8.3	0.199	0.194
45	75	16	1	0.6	68.5	3NCN1009	3NCN1009K	32.5	34.2	17 000	20 000	50	70	68.5	1	0.6	11	0.238	0.232
50	80	16	1	0.6	72.5	3NCN1010	3NCN1010K	35.2	38.9	14 000	17 000	55	75	73.5	1	0.6	12	0.259	0.252
55	90	18	1.1	1	81.0	3NCN1011	3NCN1011K	37.4	43.9	13 000	16 000	61.5	83.5	82	1	1	17	0.392	0.383
60	95	18	1.1	1	86.1	3NCN1012	3NCN1012K	38.4	46.4	12 000	14 000	66.5	88.5	87	1	1	18	0.419	0.409
65	100	18	1.1	1	91.5	3NCN1013	3NCN1013K	40.8	51.2	12 000	14 000	71.5	93.5	92	1	1	20	0.445	0.434
70	110	20	1.1	1	100	3NCN1014	3NCN1014K	57.9	70.4	11 000	13 000	76.5	103.5	101	1	1	27	0.618	0.604
75	115	20	1.1	1	106	3NCN1015	3NCN1015K	59.5	74.5	10 000	12 000	81.5	108.5	106	1	1	29	0.635	0.620
80	125	22	1.1	1	113	3NCN1016	3NCN1016K	63.1	82.2	9 400	11 000	86.5	118.5	114	1	1	36	0.874	0.854
85	130	22	1.1	1	118	3NCN1017	3NCN1017K	64.8	86.2	9 000	11 000	91.5	123	119	1	1	39	0.923	0.902
90	140	24	1.5	1.1	129	3NCN1018	3NCN1018K	96.2	122	8 300	9 800	98	132	129	1.5	1	52	1.14	1.11
95	145	24	1.5	1.1	133	3NCN1019	3NCN1019K	99.2	129	8 100	9 400	103	137	134	1.5	1	53	1.19	1.17
100	150	24	1.5	1.1	139	3NCN1020	3NCN1020K	98.6	129	7 700	9 000	108	142	139	1.5	1	56	1.25	1.22
105	160	26	2	1.1	146	3NCN1021	3NCN1021K	108	149	7 200	8 500	114	151	148	2	1	66	1.64	1.60
110	170	28	2	1.1	157	3NCN1022	3NCN1022K	134	171	6 800	7 900	119	161	157	2	1	84	2.02	1.98
120	180	28	2	1.1	167	3NCN1024	3NCN1024K	137	181	6 200	7 400	129	171	167	2	1	92	2.10	2.05
130	200	33	2	1.1	182	3NCN1026	3NCN1026K	171	238	5 700	6 600	139	191	184	2	1	135	3.23	3.16
140	210	33	2	1.1	192	3NCN1028	3NCN1028K	175	250	5 300	6 200	149	201	194	2	1	140	3.45	3.37
150	225	35	2.1	1.5	207.5	3NCN1030	3NCN1030K	201	281	4 900	5 700	161	214	208	2	1.5	177	4.14	4.04
160	240	38	2.1	1.5	219	3NCN1032	3NCN1032K	236	330	4 600	5 300	171	229	221	2	1.5	191	5.13	5.01

[Remarks] 1. For the dimensions of the spacers for oil / air lubrication, refer to Table 9. 4(6) on page 41.
 2. For the discharge intervals of the oil / air, refer to Supplementary table 6 on page 219.

3. Angular Contact Ball Bearings for Axial Load

Contents

	Page
3. 1 Types and features of angular contact ball bearings for axial load	137
3. 2 Composition of bearing numbers	138
3. 3 Tolerance of angular contact ball bearings for axial load	139
3. 4 Standard preloads for high-speed matched pair angular contact ball bearings	142
3. 5 Axial load and displacement	143
 ■ Bearing dimension tables	
· 234400B and 234700B series	146
· 239400B and 239700B series	148
· ACT000DB series	150
· ACT000BDB series	152



3. Angular contact ball bearings for axial load

JTEKT produces double direction angular contact thrust and high-speed matched pair angular contact ball bearings to receive the axial loads from spindles of machine tools.

3.1 Types and features of angular contact ball bearings for axial load

Table 3.1 Types and features of angular contact ball bearings for axial load

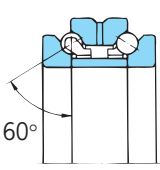
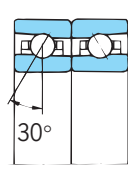
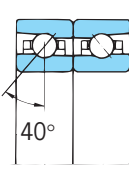
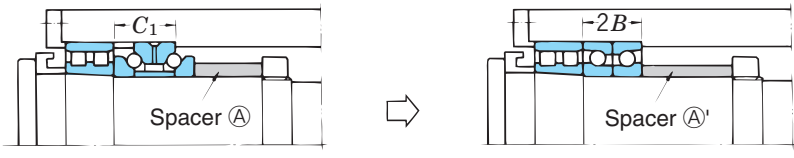
Type	Double direction angular contact thrust ball bearings	High-speed matched pair angular contact ball bearings		To combine with double row cylindrical roller bearings Remark: These bearings are used primarily in combination with double row cylindrical roller bearings for radial load. Combinations are as shown below.
				
Diameter series				
0	2344 B	ACT 0 DB	ACT 0 BDB	Placed next to the small tapered bore diameter side of NN30K, or used in tandem with NN30 (cylindrical bore).
	2347 B	—	—	Placed next to the large tapered bore diameter side of NN30K.
9	2394 B	—	—	Placed next to the small tapered bore diameter side of NNU49K, or used in tandem with NNU49 (cylindrical bore).
	2397 B	—	—	Placed next to the large tapered-bore diameter side of NNU49K.
Features	<ul style="list-style-type: none"> • Axial load can be applied in both directions, and the rigidity in the axial direction is high. • Bearings having greater contact angles are more suitable where rigidity is a priority, and those having smaller contact angles are more appropriate where high-speed performance is a priority. 	<ul style="list-style-type: none"> • Negative tolerances on the outside diameters are used to permit axial load only. • Having small contact angles, these are suitable for high-speed rotations. • These bearings are interchangeable with 2344 B series. 		
Interchangeability	 <p>Example of mounting in tandem with 2344 B</p> <p>Example of mounting in tandem with ACT 0 DB or ACT 0 BDB</p> <p>Since the combined width "2B" of ACT 0 DB and ACT 0 BDB is equal to dimension "C₁" of 2344 B, it is not necessary to change shaft and housing dimensions. Changing the width of spacer ① is sufficient.</p>			

3. Angular contact ball bearings for axial load

3.2 Composition of bearing numbers (angular contact ball bearings for axial load)

Double direction angular contact thrust ball bearings

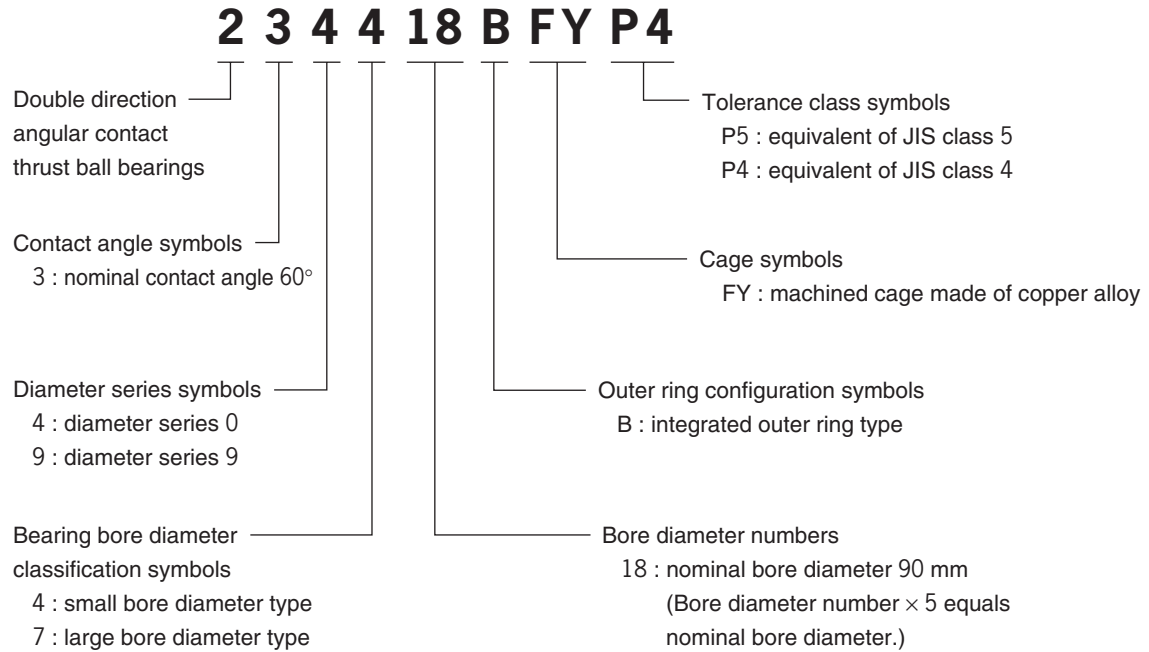

High-speed matched pair angular contact ball bearings

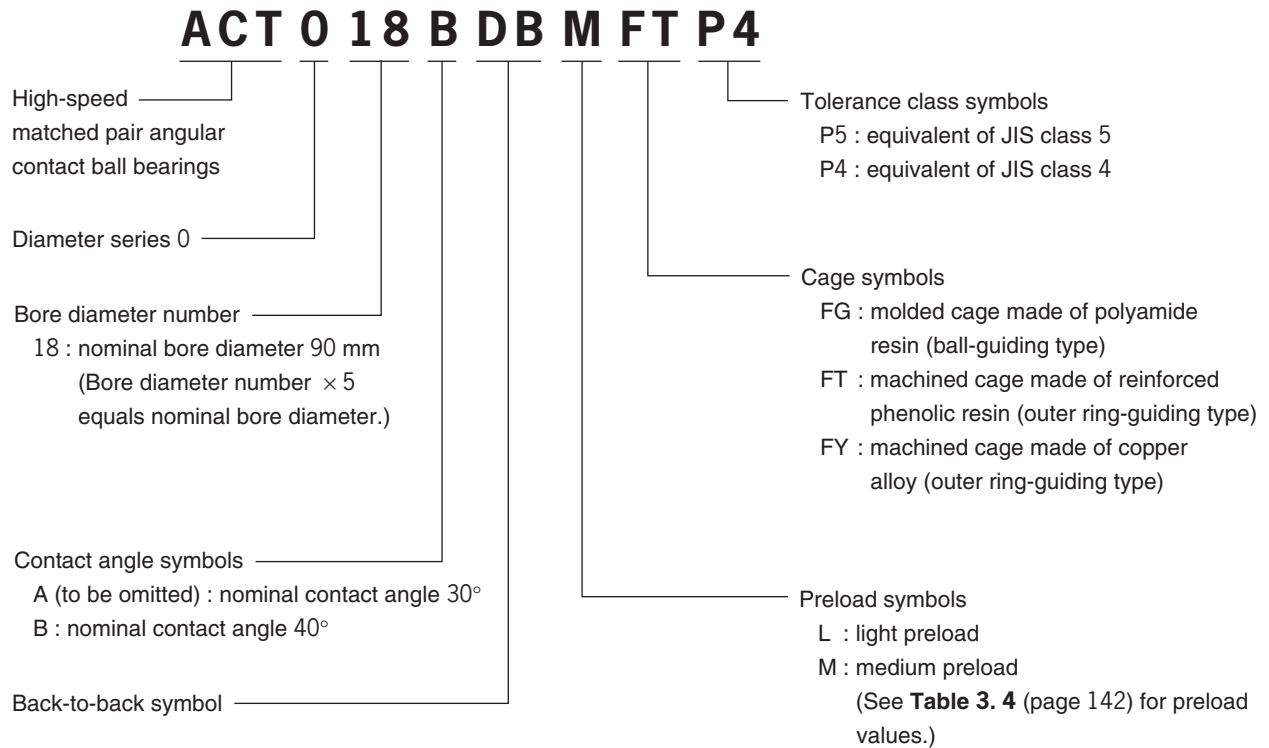

3.3 Tolerance of angular contact ball bearings for axial load

The tolerance of double direction angular contact thrust ball bearings is shown in **Table 3.2**.
The tolerance of high-speed matched pair angular contact ball bearings is shown in **Table 3.3** (page 140

and 141).
The tolerance of these bearings complies with **JTEKT** standards Classes 5 and 4 (equivalent of JIS Classes 5 and 4).

Table 3.2 Permissible dimensional deviations and limits to double direction angular contact thrust ball bearings (JTEKT standards)

(1) Inner ring and assembled bearing width

Unit : μm

Nominal bore diameter d (mm)		Δ_{dmp} or Δ_{ds} ¹⁾				Actual bearing width deviation Δ_{Ts}		Inner ring width variation V_{Bs}		Perpendicularity of inner ring face with respect to the bore S_d		Axial runout of assembled bearing inner ring S_{ia}	
		Class 5		Class 4		Classes 5, 4		Class 5	Class 4	Class 5	Class 4	Class 5	Class 4
over	up to	upper	lower	upper	lower	upper	lower	max.		max.		max.	
18	30	0	-6	0	-5	0	-300	5	2.5	8	4	5	3
30	50	0	-8	0	-6	0	-400	5	3	8	4	5	3
50	80	0	-9	0	-7	0	-500	6	4	8	4	6	5
80	120	0	-10	0	-8	0	-600	7	4	9	5	6	5
120	180	0	-13	0	-10	0	-700	8	5	10	6	8	6
180	250	0	-15	0	-12	0	-800	10	6	11	7	8	6
250	315	0	-18	0	-15	0	-900	13	7	13	8	10	8
315	400	0	-23	0	-18	0	-1 000	15	9	15	9	13	10

(2) Outer ring

Unit : μm

Nominal outside diameter D (mm)		Δ_{Dmp} or Δ_{Ds} ²⁾		Outer ring width variation V_{Cs}		Perpendicularity of outer ring outside surface with respect to the face S_D		Axial runout of assembled bearing outer ring S_{ea}
		Classes 5, 4		Class 5	Class 4	Class 5	Class 4	Classes 5, 4
over	up to	upper	lower	max.		max.		max.
30	50	-30	-40	5	2.5	8	4	Same as permissible values S_{ia} , d being that of the same bearing.
50	80	-40	-50	6	3	8	4	
80	120	-50	-60	8	4	9	5	
120	150	-60	-75	8	5	10	5	
150	180	-60	-75	8	5	10	5	
180	250	-75	-90	10	7	11	7	
250	315	-90	-105	11	7	13	8	
315	400	-110	-125	13	8	13	10	
400	500	-120	-140	15	10	15	13	

- [Notes] 1) Single plane mean bore diameter deviation or single bore diameter deviation
2) Single plane mean outside diameter deviation or single outside diameter deviation

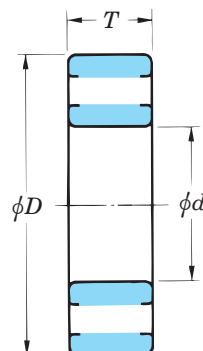

d : nominal bore diameter
 D : nominal outside diameter
 T : nominal bearing width

3. Angular contact ball bearings for axial load

Table 3. 3(1) Permissible dimensional deviations and limits of high-speed matched pair angular contact ball bearings (JTEKT standards)

(1) Inner ring

Unit : μm

Nominal bore diameter d (mm)		Single plane mean bore diameter deviation Δ_{dmp}				Single bore diameter deviation $\Delta_{ds}^{1)}$		Single plane bore diameter variation V_{dsp}				Mean bore diameter variation V_{dmp}	
								Diameter series 9		Diameter series 0			
		Class 5		Class 4		Class 4		Class 5	Class 4	Class 5	Class 4	Class 5	Class 4
over	up to	upper	lower	upper	lower	upper	lower	max.		max.		max.	
18	30	0	-6	0	-5	0	-5	6	5	5	4	3	2.5
30	50	0	-8	0	-6	0	-6	8	6	6	5	4	3
50	80	0	-9	0	-7	0	-7	9	7	7	5	5	3.5
80	120	0	-10	0	-8	0	-8	10	8	8	6	5	4
120	150	0	-13	0	-10	0	-10	13	10	10	8	7	5
150	180	0	-13	0	-10	0	-10	13	10	10	8	7	5
180	250	0	-15	0	-12	0	-12	15	12	12	9	8	6
250	315	0	-18	0	-15	0	-15	18	15	14	11	9	8
315	400	0	-23	0	-18	0	-18	23	18	18	14	12	9

Nominal bore diameter d (mm)		Radial runout of assembled bearing inner ring K_{ia}		Perpendicularity of inner ring face with respect to the bore S_d		Axial runout of assembled bearing inner ring S_{ia}		Single inner ring width deviation Δ_{Bs}		Single inner ring width deviation $\Delta_{Bs}^{2)}$		Inner ring width variation V_{Bs}	
		Class 5	Class 4	Class 5	Class 4	Class 5	Class 4	Classes 5, 4		Classes 5, 4		Class 5	Class 4
over	up to	max.		max.		max.		upper	lower	upper	lower	max.	
18	30	4	3	8	4	8	4	0	-120	0	-250	5	2.5
30	50	5	4	8	4	8	4	0	-120	0	-250	5	3
50	80	5	4	8	5	8	5	0	-150	0	-250	6	4
80	120	6	5	9	5	9	5	0	-200	0	-380	7	4
120	150	8	6	10	6	10	7	0	-250	0	-380	8	5
150	180	8	6	10	6	10	7	0	-250	0	-380	8	5
180	250	10	8	11	7	13	8	0	-300	0	-500	10	6
250	315	13	10	13	8	15	9	0	-350	0	-500	13	8
315	400	15	13	15	9	20	12	0	-400	0	-630	15	9

[Notes] 1) Tolerance class 4 is applied to bearings of diameter series 0.

2) Applied to individual bearing rings manufactured for matched pair or stack bearings.

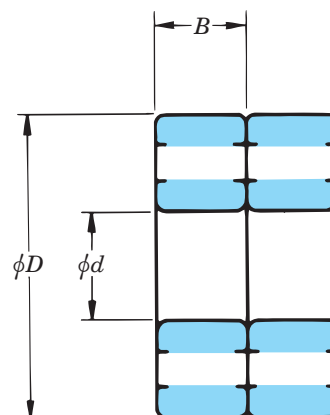

d : nominal bore diameter
 D : nominal outside diameter
 B : nominal bearing width

Table 3. 3(2) Permissible dimensional deviations and limits for high-speed matched pair angular contact ball bearings (JTEKT standards)

(2) Outer ring

Unit : μm

Nominal outside diameter D (mm)		$\Delta_{D_{mp}}$ or $\Delta_{D_s}^{1), 2)}$		Single plane outside diameter variation				Mean outside diameter variation $V_{D_{mp}}$	
				$V_{D_{sp}}$					
				Classes 5, 4		Diameter series 9		Diameter series 0	
over	up to	upper	lower	max.		max.		max.	
50	80	-32	- 47	9	7	7	5	5	3.5
80	120	-39	- 56	10	8	8	6	5	4
120	150	-44	- 66	11	9	8	7	6	5
150	180	-44	- 68	13	10	10	8	7	5
180	250	-51	- 79	15	11	11	8	8	6
250	315	-56	- 89	18	13	14	10	9	7
315	400	-63	- 99	20	15	15	11	10	8
400	500	-71	-111	23	17	17	13	12	9

Nominal outside diameter D (mm)		Radial runout of assembled bearing outer ring K_{ea}		Perpendicularity of outer ring out side surface with respect to the face S_D		Axial runout of assembled bearing outer ring S_{ea}		Deviation of a single outer ring width Δ_{C_s}		Ring width variation V_{C_s}	
		Class 5	Class 4	Class 5	Class 4	Class 5	Class 4	Classes 5, 4		Class 5	Class 4
over	up to	max.		max.		max.		upper	lower	max.	
50	80	8	5	8	4	10	5	Same as tolerance Δ_{B_s} , d being that of the same bearing.		6	3
80	120	10	6	9	5	11	6		8	4	
120	150	11	7	10	5	13	7		8	5	
150	180	13	8	10	5	14	8		8	5	
180	250	15	10	11	7	15	10		10	7	
250	315	18	11	13	8	18	10		11	7	
315	400	20	13	13	10	20	13	13	8		
400	500	23	15	15	12	23	15	15	9		

- [Notes] 1) Single plane mean outside diameter deviation or single outside diameter deviation
 2) Dimensional tolerance for outside diameter of class 4 is applied to bearings of diameter series 0.

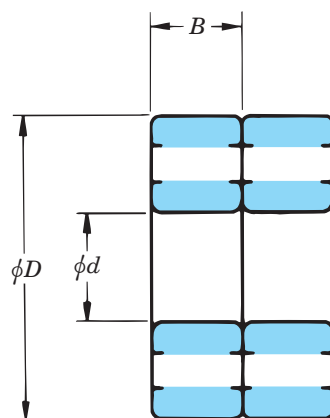

d : nominal bore diameter
 D : nominal outside diameter
 B : nominal bearing width

3.4 Standard preloads for high-speed matched pair angular contact ball bearings

Table 3.4 shows standard preloads for high-speed matched pair angular contact ball bearings.

Table 3.4 Standard preloads for high-speed matched pair angular contact ball bearings

(L : light preload; M : medium preload) Unit : N

Bore diameter number	ACT 000		ACT 000 B	
	L	M	L	M
06	195	345	295	685
07	195	390	390	735
08	245	440	440	835
09	245	490	490	930
10	295	540	540	1 030
11	390	685	685	1 270
12	390	735	735	1 420
13	440	835	785	1 520
14	590	1 130	1 030	2 010
15	590	1 130	1 080	2 110
16	685	1 370	1 270	2 500
17	735	1 420	1 320	2 600
18	980	1 860	1 770	3 380
19	980	1 960	1 860	3 530
20	1 030	2 010	1 910	3 680
21	1 180	2 250	2 150	3 770
22	1 320	2 600	2 450	4 760
24	1 420	2 800	2 550	5 100
26	1 770	3 380	3 230	6 230
28	2 010	3 920	3 720	7 210
30	2 400	4 610	4 410	8 480
32	2 500	4 850	4 660	8 920
34	3 090	6 030	5 730	9 320
36	3 530	6 860	6 570	10 500
38	3 780	7 160	6 960	10 800
40	4 410	8 530	8 040	13 000
44	5 200	9 710	8 430	15 300
48	5 540	10 000	8 680	15 800
52	6 620	12 400	10 800	19 600
56	6 820	12 700	11 100	20 200
60	7 700	14 400	12 700	23 000
64	7 750	14 500	12 700	23 000

3.5 Axial load and displacement (angular contact ball bearings for axial load)

Fig. 3. 1 show relationships between axial load and displacement respectively for double direction angular contact thrust and high-speed matched pair angular

contact ball bearings when a standard preload is applied.

(1) 234400B and 234700B series (contact angle : 60°)

(2) 239400B and 239700B series (contact angle : 60°)

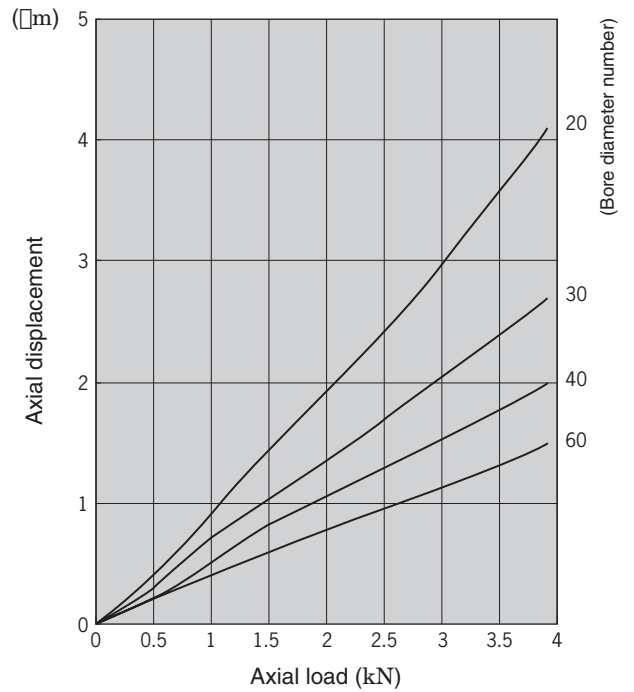
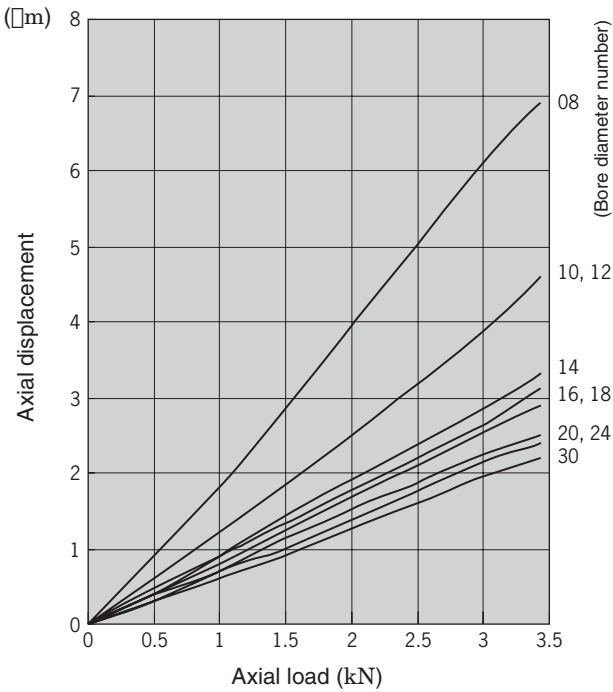
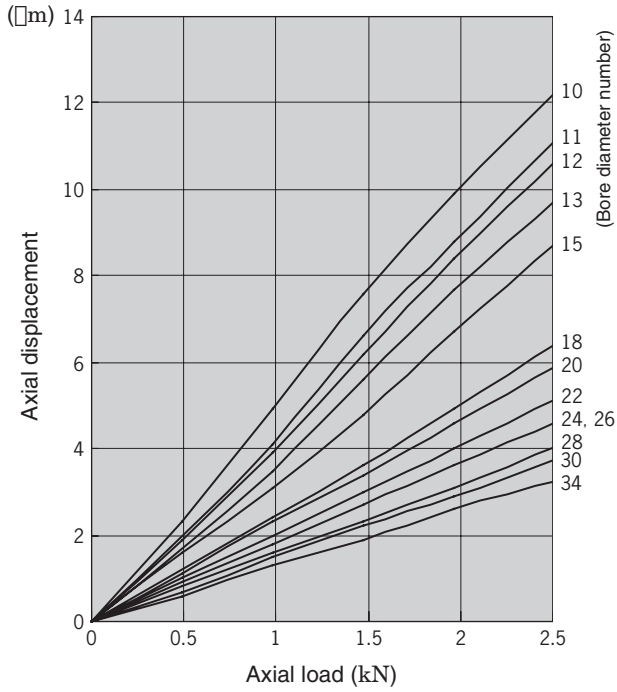

Fig. 3. 1(1) Relationships between axial load and displacement (double direction angular contact thrust ball bearings)

3. Angular contact ball bearings for axial load

(3) ACT000 series (contact angle 30°)

a) When preload L is applied



(4) ACT000B series (contact angle 40°)

a) When preload L is applied

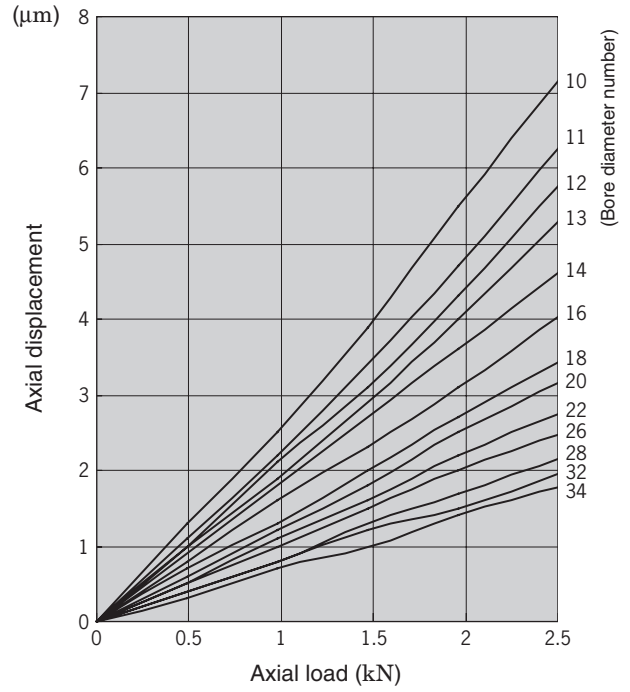

b) When preload M is applied

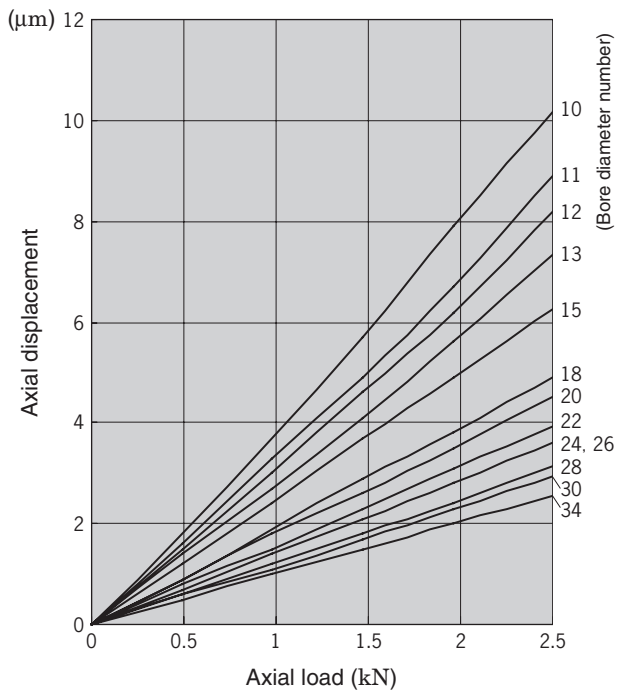

b) When preload M is applied

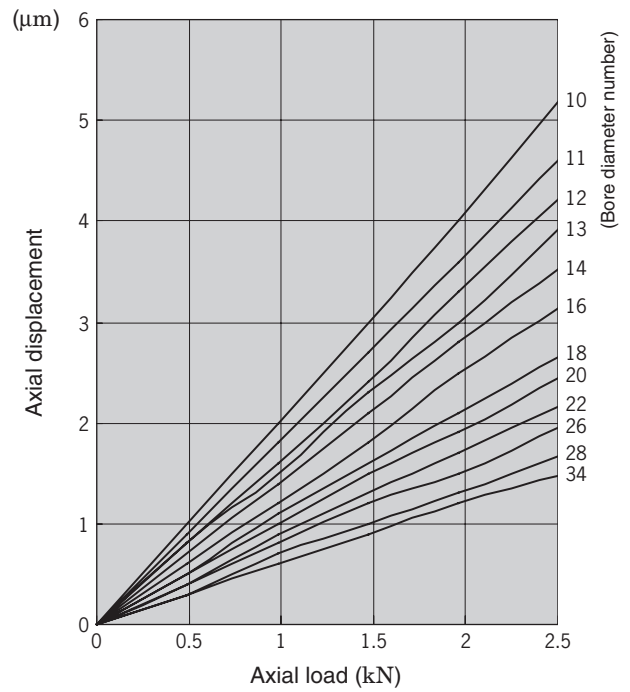
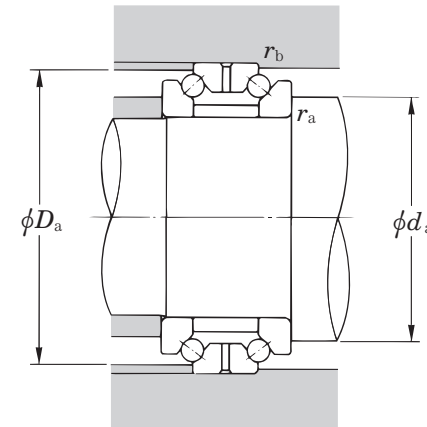
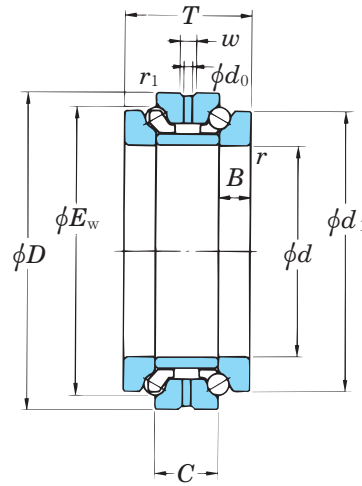

Fig. 3. 1(2) Relationships between axial load and displacement (high-speed matched pair angular contact ball bearings)

3. Angular contact ball bearings for axial load

234400B series
234700B series

Contact angle 60°



Dynamic equivalent load $P_a = F_a$
Static equivalent load $P_{0a} = F_a$

Small bore dia. type	Large bore dia. type	Boundary dimensions (mm)					Bearing No. ¹⁾		Basic load ratings (kN)		Limiting speeds (min ⁻¹)		Dimensions (mm)				Mounting dimensions (mm)				Amount of grease fill (cm ³ /row)	(Refer.) Mass (kg)		
		D	T	C	r min.	r ₁ min.	Small bore dia. type	Large bore dia. type	C _a	C _{0a}	Grease lub.	Oil lub.	E _w ²⁾	d ₁	B	d ₀	w	d _a min.	D _a max.	r _a max.		r _b max.	Small bore dia. type	Large bore dia. type
25	—	47	28	14	0.6	0.3	234405B	—	13.2	19.9	7 700	11 000	41.3	40	7	2	4.5	33	44	0.6	0.3	0.18~0.26	0.194	—
30	32	55	32	16	1	0.6	234406B	234706B	14.0	23.6	6 700	9 500	48.5	47	8	2	4.5	40	50.5	1	0.6	0.30~0.45	0.296	0.272
35	37	62	34	17	1	0.6	234407B	234707B	20.8	34.8	6 100	8 700	55	53	8.5	2	4.5	45.5	57.5	1	0.6	0.40~0.60	0.388	0.357
40	42	68	36	18	1	0.6	234408B	234708B	23.9	41.7	5 700	8 100	61	58.5	9	2	4.5	50	63.5	1	0.6	0.50~0.75	0.475	0.437
45	47	75	38	19	1	0.6	234409B	234709B	26.0	50.1	5 200	7 500	67.5	65	9.5	2	4.5	56.5	70.5	1	0.6	0.65~0.98	0.602	0.554
50	52	80	38	19	1	0.6	234410B	234710B	26.8	54.4	5 100	7 300	72.5	70	9.5	2	4.5	61.5	75.5	1	0.6	0.70~1.1	0.654	0.602
55	57	90	44	22	1.1	0.6	234411B	234711B	37.2	71.7	4 400	6 400	81	78	11	4	8	67.5	84	1	0.6	1.0~1.5	0.978	0.900
60	62	95	44	22	1.1	0.6	234412B	234712B	37.6	75.2	4 300	6 200	86.1	83	11	4	8	72.5	89	1	0.6	1.1~1.7	1.04	0.957
65	67	100	44	22	1.1	0.6	234413B	234713B	39.0	81.8	4 200	6 000	91	88	11	4	8	77.5	94	1	0.6	1.2~1.7	1.11	1.02
70	73	110	48	24	1.1	0.6	234414B	234714B	47.5	103	3 800	5 500	100	97	12	4	8	85	104	1	0.6	1.7~2.5	1.52	1.40
75	78	115	48	24	1.1	0.6	234415B	234715B	49.1	111	3 700	5 300	105	102	12	4	8	90	109	1	0.6	1.8~2.6	1.62	1.49
80	83	125	54	27	1.1	0.6	234416B	234716B	57.6	132	3 400	4 800	113	110	13.5	4	8	96.5	119	1	0.6	2.4~3.6	2.19	2.03
85	88	130	54	27	1.1	0.6	234417B	234717B	58.2	137	3 300	4 700	118	115	13.5	4	8	102	124	1	0.6	2.5~3.8	2.30	2.12
90	93	140	60	30	1.5	1	234418B	234718B	67.4	160	3 000	4 300	127	123	15	4	8	109	133.5	1.5	1	3.3~4.9	3.03	2.79
95	98	145	60	30	1.5	1	234419B	234719B	68.0	166	3 000	4 200	132	128	15	4	8	114	138.5	1.5	1	3.4~5.0	3.17	2.92
100	103	150	60	30	1.5	1	234420B	234720B	68.7	172	2 900	4 100	137	133	15	4	8	119	143.5	1.5	1	3.4~5.1	3.33	3.06
105	109	160	66	33	2	1	234421B	234721B	78.8	199	2 700	3 800	146	142	16.5	6	12	127	152	2	1	4.7~7.1	4.15	3.82
110	114	170	72	36	2	1	234422B	234722B	95.9	235	2 500	3 500	155	150	18	6	12	133	162	2	1	5.9~8.8	5.38	4.95
120	124	180	72	36	2	1	234424B	234724B	98.3	252	2 400	3 400	165	160	18	6	12	143	172	2	1	6.4~9.5	5.77	5.31
130	135	200	84	42	2	1	234426B	234726B	139	340	2 100	3 000	182	177	21	6	12	155	192	2	1	9.3~13.9	8.63	7.94
140	145	210	84	42	2	1	234428B	234728B	144	366	2 000	2 900	192	187	21	6	12	165	202	2	1	9.7~14.5	9.18	8.44
150	155	225	90	45	2.1	1.1	234430B	234730B	147	394	1 900	2 700	206	200	22.5	6	14	178	215	2	1	12.0~17.9	11.3	10.4
160	165	240	96	48	2.1	1.1	234432B	234732B	173	460	1 700	2 500	219	212	24	6	14	189	230	2	1	14.1~21.1	13.3	12.2
170	176	260	108	54	2.1	1.1	234434B	234734B	203	547	1 600	2 200	236	230	27	6	14	203	250	2	1	18.6~27.8	18.1	16.6
180	187	280	120	60	2.1	1.1	234436B	234736B	234	642	1 400	2 000	255	248	30	8	16	219	270	2	1	23.4~35.1	24.9	22.9
190	197	290	120	60	2.1	1.1	234438B	234738B	237	665	1 400	1 900	265	258	30	8	16	229	280	2	1	24.7~37.1	25.0	23.0
200	207	310	132	66	2.1	1.1	234440B	234740B	279	771	1 200	1 800	282	274	33	8	16	243	300	2	1	31.8~47.7	32.1	29.5
220	228	340	144	72	3	1.1	234444B	234744B	334	939	1 100	1 600	310	304	36	12	22	267	330	2.5	1	43.0~64.4	42.0	38.6
240	248	360	144	72	3	1.1	234448B	234748B	342	1 010	1 100	1 500	330	322	36	12	22	287	350	2.5	1	47.7~71.6	45.0	41.4
260	269	400	164	82	4	1.5	234452B	234752B	406	1 270	920	1 300	364	354	41	12	22	315	388	3	1.5	67.0~101	65.8	60.5
280	289	420	164	82	4	1.5	234456B	234756B	417	1 360	880	1 300	384	374	41	12	22	335	408	3	1.5	73.5~110	69.8	64.2
300	310	460	190	95	4	1.5	234460B	234760B	476	1 630	760	1 100	418	406	47.5	12	22	364	448	3	1.5	98.0~147	100	91.8
320	330	480	190	95	4	1.5	234464B	234764B	479	1 680	730	1 000	438	426	47.5	12	22	384	468	3	1.5	108~162	106	97.5

[Notes] 1) The small bore diameter type bearing is placed next to the small tapered-bore diameter side of the NN30K, or used in tandem with NN30.
The large bore diameter type bearing is placed next to the large tapered-bore diameter side of NN30K.
2) The dimension E_w is used as a reference for the ball set outside diameter.

3. Angular contact ball bearings for axial load

239400B series
239700B series

Contact angle 60°

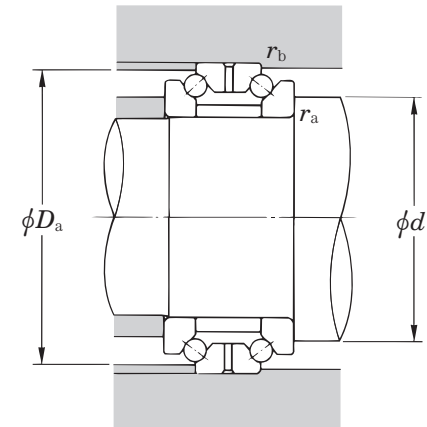
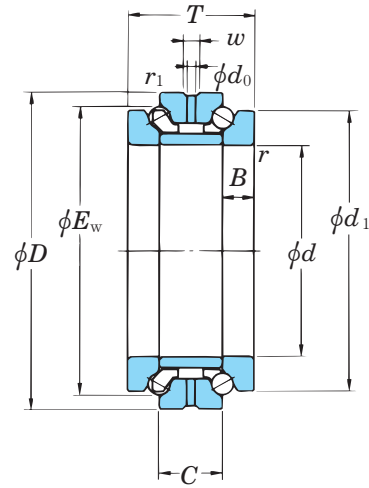

Dynamic equivalent load $P_a = F_a$
Static equivalent load $P_{0a} = F_a$

Small bore dia. type	Large bore dia. type	Boundary dimensions (mm)					Bearing No. ¹⁾		Basic load ratings (kN)		Limiting speeds (min ⁻¹)		Dimensions (mm)				Mounting dimensions (mm)				Amount of grease fill (cm ³ /row)	(Refer.) Mass (kg)		
		D	T	C	r min.	r ₁ min.	Small bore dia. type	Large bore dia. type	C _a	C _{0a}	Grease lub.	Oil lub.	E _w ²⁾	d ₁	B	d ₀	w	d _a min.	D _a max.	r _a max.		r _b max.	Small bore dia. type	Large bore dia. type
100	—	140	48	24	1.1	0.6	239420B	—	52.2	135	2 800	3 800	131	126	12	4	8	114	134	1	0.6	3.1~4.6	2.08	—
105	—	145	48	24	1.1	0.6	239421B	—	53.6	143	2 700	3 800	136	131	12	4	8	119	139	1	0.6	3.1~4.6	2.16	—
110	—	150	48	24	1.1	0.6	239422B	—	53.9	148	2 700	3 700	141	136	12	4	8	124	144	1	0.6	3.0~4.5	2.25	—
120	124	165	54	27	1.1	0.6	239424B	239724B	64.9	185	2 400	3 300	154.5	150	13.5	4	8	138	160	1	0.6	4.2~6.3	3.12	2.81
130	134	180	60	30	1.5	1	239426B	239726B	75.0	217	2 100	3 000	168	163	15	4	8	150	172	1.5	1	5.8~8.7	4.19	3.77
140	144	190	60	30	1.5	1	239428B	239728B	75.9	229	2 100	2 900	178	173	15	4	8	160	182	1.5	1	6.3~9.4	4.47	4.03
150	155	210	72	36	2	1	239430B	239730B	107	312	1 800	2 500	196.5	190	18	4	8	174	200	2	1	9.6~14.4	7.01	6.31
160	165	220	72	36	2	1	239432B	239732B	109	329	1 700	2 400	206.5	200	18	4	8	184	210	2	1	9.3~14.0	7.40	6.66
170	175	230	72	36	2	1	239434B	239734B	111	346	1 700	2 300	216.5	210	18	4	8	194	220	2	1	10.8~16.2	7.79	7.01
180	186	250	84	42	2	1	239436B	239736B	157	460	1 500	2 100	234	227	21	4	8	207	240	2	1	14.9~22.3	11.3	10.2
190	196	260	84	42	2	1	239438B	239738B	157	474	1 400	2 000	242	237	21	4	8	217	250	2	1	15.7~23.5	11.9	10.7
200	207	280	96	48	2.1	1.1	239440B	239740B	185	557	1 300	1 800	259	252	24	4	8	231	268	2	1	23.5~35.2	16.6	14.9
220	227	300	96	48	2.1	1.1	239444B	239744B	191	606	1 200	1 700	280	272	24	6	12	251	288	2	1	24.7~37.0	18.0	16.2
240	247	320	96	48	2.1	1.1	239448B	239748B	196	655	1 200	1 600	299	292	24	6	12	271	308	2	1	26.4~39.5	19.1	17.2
260	269	360	120	60	2.1	1.1	239452B	239752B	261	869	950	1 300	335	328	30	6	12	299	344	2	1	43.7~65.5	33.5	30.2
280	289	380	120	60	2.1	1.1	239456B	239756B	265	915	910	1 300	356	348	30	6	14	319	363	2	1	49.1~73.7	35.7	32.1
300	310	420	144	72	3	1.1	239460B	239760B	352	1 150	770	1 100	391	384	36	6	14	349	398	2.5	1	71.5~107	56.1	50.5
320	330	440	144	72	3	1.1	239464B	239764B	361	1 220	740	1 000	408	404	36	6	14	369	419	2.5	1	81.5~122	59.2	53.3
340	—	460	144	72	3	1.1	239468B	—	368	1 290	710	980	428	424	36	8	16	389	438	2.5	1	84.5~127	63.1	—

[Notes] 1) The small bore diameter type bearing is placed next to the small tapered-bore diameter side of the NNU49K, or used in tandem with NNU49.
The large bore diameter type bearing is placed next to the large tapered-bore diameter side of NNU49K.
2) The dimension E_w is used as a reference for the ball set outside diameter.

3. Angular contact ball bearings for axial load

ACT000DB series

Contact angle 30°

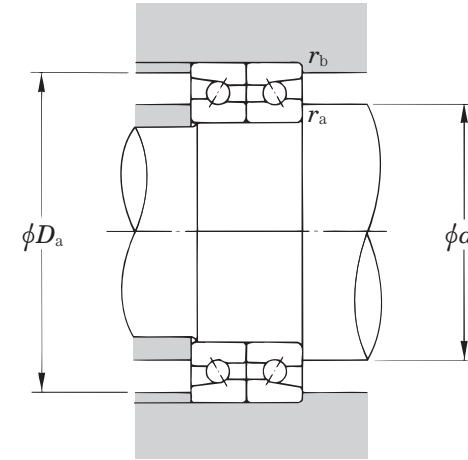
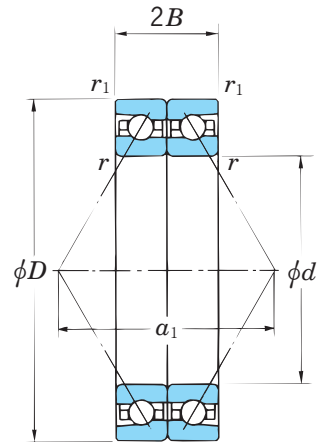

Dynamic equivalent load $P_a = F_a$
 Static equivalent load $P_{0a} = F_a$

d	Boundary dimensions (mm)				Bearing No.	Basic load ratings (kN)		Limiting speeds (min ⁻¹)		Permissible axial loads (kN) (static)	Load center spread (mm) a ₁	Mounting dimensions (mm)				Interspace volume (cm ³ /row)	(Refer.) Mass (kg/row)
	D	2B	r min.	r ₁ min.		C _a	C _{0a}	Grease lub.	Oil lub.			d _a min.	D _a max.	r _a max.	r _b max.		
30	55	24	1	0.6	ACT006DB	15.1	26.6	15 000	20 000	2.92	48.5	41	50	1	0.6	3.0	0.235
35	62	25.5	1	0.6	ACT007DB	15.8	30.2	13 000	17 000	3.25	53.5	46	57	1	0.6	4.2	0.312
40	68	27	1	0.6	ACT008DB	16.5	33.8	12 000	15 000	3.58	58.2	51	63	1	0.6	5.0	0.391
45	75	28.5	1	0.6	ACT009DB	18.4	38.6	11 000	14 000	3.84	63.1	56	70	1	0.6	5.7	0.536
50	80	28.5	1	0.6	ACT010DB	19.1	41.7	9 700	13 000	4.20	51.8	61	75	1	0.6	8.0	0.551
55	90	33	1.1	0.6	ACT011DB	23.7	52.8	8 700	11 000	5.63	58.4	68	84	1	0.6	12	0.831
60	95	33	1.1	0.6	ACT012DB	24.6	56.9	8 100	11 000	6.11	61.2	73	89	1	0.6	13	0.887
65	100	33	1.1	0.6	ACT013DB	25.4	60.9	7 600	10 000	6.59	64.1	78	94	1	0.6	14	0.943
70	110	36	1.1	0.6	ACT014DB	34.8	82.1	7 000	9 200	8.39	70.0	85	104	1	0.6	16	1.33
75	115	36	1.1	0.6	ACT015DB	35.3	84.9	6 600	8 700	8.74	72.8	90	109	1	0.6	20	1.35
80	125	40.5	1.1	0.6	ACT016DB	41.3	101	6 100	8 000	10.8	79.4	97	118	1	0.6	27	1.86
85	130	40.5	1.1	0.6	ACT017DB	41.9	105	5 800	7 600	11.2	82.3	102	123	1	0.6	29	1.94
90	140	45	1.5	1	ACT018DB	55.0	138	5 400	7 100	14.2	88.9	109	132	1.5	1	39	2.55
95	145	45	1.5	1	ACT019DB	55.8	143	5 200	6 800	14.8	91.8	114	137	1.5	1	40	2.62
100	150	45	1.5	1	ACT020DB	56.6	148	5 000	6 500	15.3	94.7	119	143	1.5	1	42	2.77
105	160	49.5	2	1	ACT021DB	64.4	170	4 700	6 100	18.2	101.2	125	151	2	1	50	3.61
110	170	54	2	1	ACT022DB	72.4	193	4 400	5 800	19.6	107.8	132	160	2	1	64	4.52
120	180	54	2	1	ACT024DB	74.6	206	4 100	5 400	21.0	113.6	142	170	2	1	69	4.83
130	200	63	2	1	ACT026DB	94.2	253	3 700	4 800	25.9	126.8	156	188	2	1	106	7.21
140	210	63	2	1	ACT028DB	102	290	3 400	4 500	29.9	132.5	166	198	2	1	110	7.69
150	225	67.5	2.1	1.1	ACT030DB	120	344	3 200	4 200	34.7	142.0	178	213	2	1	138	9.39
160	240	72	2.1	1.1	ACT032DB	130	377	3 000	3 900	39.1	151.5	190	227	2	1	167	11.4
170	260	81	2.1	1.1	ACT034DB	153	449	2 700	3 600	45.7	164.6	204	245	2	1	221	15.7
180	280	90	2.1	1.1	ACT036DB	173	510	2 500	3 300	54.0	222.8	216	264	2	1	313	22.2
190	290	90	2.1	1.1	ACT038DB	179	544	2 400	3 100	57.9	228.6	226	275	2	1	329	23.0
200	310	99	2.1	1.1	ACT040DB	215	633	2 200	2 900	64.8	246.2	240	293	2	1	421	29.5
220	340	108	3	1.1	ACT044DB	252	773	2 000	2 600	81.9	269.7	263	321	2.5	1	566	38.5
240	360	108	3	1.1	ACT048DB	260	823	1 800	2 400	87.9	281.2	283	343	2.5	1	605	41.1
260	400	123	4	1.5	ACT052DB	321	1 090	1 600	2 100	111	313.5	310	379	3	1.5	866	60.5
280	420	123	4	1.5	ACT056DB	332	1 160	1 500	2 000	119	325.1	330	401	3	1.5	915	64.1
300	460	142.5	4	1.5	ACT060DB	375	1 370	1 300	1 800	143	361.9	358	435	3	1.5	1 320	92.1
320	480	142.5	4	1.5	ACT064DB	378	1 420	1 200	1 600	148	373.4	378	457	3	1.5	1 400	96.9

[Remark] This bearing is interchangeable with 234400B as their bore and outside diameters are the same.

ACT000BDB series

Contact angle 40°

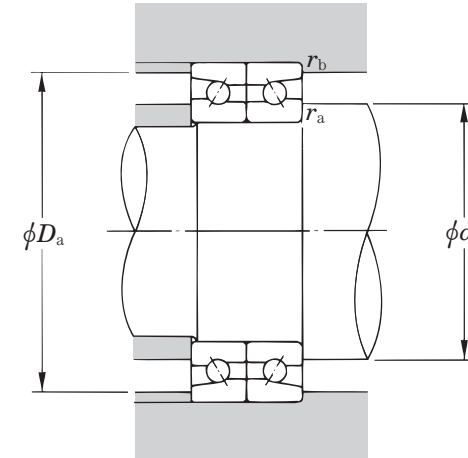
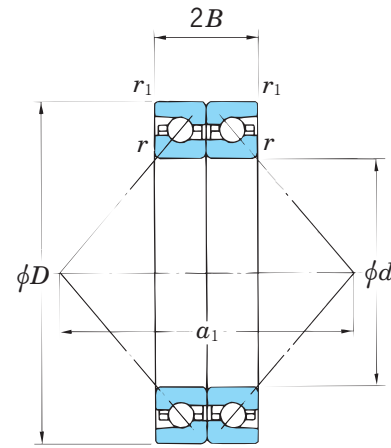

Dynamic equivalent load $P_a = F_a$
 Static equivalent load $P_{0a} = F_a$

d	Boundary dimensions (mm)				Bearing No.	Basic load ratings (kN)		Limiting speeds (min ⁻¹)		Permissible axial loads (kN) (static)	Load center spread (mm) a ₁	Mounting dimensions (mm)				Interspace volume (cm ³ /row)	(Refer.) Mass (kg/row)
	D	2B	r min.	r ₁ min.		C _a	C _{0a}	Grease lub.	Oil lub.			d _a min.	D _a max.	r _a max.	r _b max.		
30	55	24	1	0.6	ACT006BDB	18.1	30.5	13 000	18 000	9.86	59.6	41	50	1	0.6	3.0	0.235
35	62	25.5	1	0.6	ACT007BDB	18.9	34.5	12 000	15 000	10.9	66.2	46	57	1	0.6	4.2	0.312
40	68	27	1	0.6	ACT008BDB	19.6	37.7	11 000	14 000	12.1	72.3	51	63	1	0.6	5.0	0.391
45	75	28.5	1	0.6	ACT009BDB	21.8	42.7	9 500	13 000	13.2	78.8	56	70	1	0.6	5.7	0.536
50	80	28.5	1	0.6	ACT010BDB	22.7	46.3	8 800	12 000	14.5	83.0	61	75	1	0.6	8.0	0.551
55	90	33	1.1	0.6	ACT011BDB	28.1	58.6	7 900	10 000	19.0	89.3	68	84	1	0.6	12	0.831
60	95	33	1.1	0.6	ACT012BDB	29.1	63.1	7 400	9 700	20.6	93.5	73	89	1	0.6	13	0.887
65	100	33	1.1	0.6	ACT013BDB	30.1	67.6	6 900	9 000	22.2	85.8	78	94	1	0.6	14	0.945
70	110	36	1.1	0.6	ACT014BDB	41.3	91.1	6 300	8 300	28.8	93.5	85	104	1	0.6	16	1.33
75	115	36	1.1	0.6	ACT015BDB	41.8	94.2	6 000	7 800	30.0	97.7	90	109	1	0.6	20	1.35
80	125	40.5	1.1	0.6	ACT016BDB	49.1	112	5 500	7 200	36.6	106.3	97	118	1	0.6	27	1.86
85	130	40.5	1.1	0.6	ACT017BDB	49.7	116	5 200	6 900	38.0	110.5	102	123	1	0.6	29	1.94
90	140	45	1.5	1	ACT018BDB	65.3	153	4 900	6 400	48.7	119.0	109	132	1.5	1	39	2.55
95	145	45	1.5	1	ACT019BDB	66.3	159	4 700	6 200	50.6	123.2	114	137	1.5	1	40	2.62
100	150	45	1.5	1	ACT020BDB	67.2	164	4 500	5 900	52.5	127.4	119	143	1.5	1	42	2.77
105	160	49.5	2	1	ACT021BDB	76.4	188	4 200	5 500	63.2	135.9	125	151	2	1	50	3.61
110	170	54	2	1	ACT022BDB	86.0	214	4 000	5 200	71.3	144.5	132	160	2	1	64	4.52
120	180	54	2	1	ACT024BDB	88.4	228	3 700	4 900	76.4	152.9	142	170	2	1	69	4.83
130	200	63	2	1	ACT026BDB	112	281	3 300	4 400	93.0	170.0	156	188	2	1	106	7.21
140	210	63	2	1	ACT028BDB	121	323	3 100	4 100	107	178.3	166	198	2	1	110	7.65
150	225	67.5	2.1	1.1	ACT030BDB	143	382	2 900	3 800	125	191.1	178	213	2	1	138	9.39
160	240	72	2.1	1.1	ACT032BDB	155	419	2 700	3 500	139	203.8	190	227	2	1	167	11.4
170	260	81	2.1	1.1	ACT034BDB	181	499	2 500	3 200	163	221.0	204	245	2	1	221	15.7
180	280	90	2.1	1.1	ACT036BDB	205	566	2 300	3 000	183	283.0	216	264	2	1	313	22.2
190	290	90	2.1	1.1	ACT038BDB	213	604	2 200	2 800	196	291.4	226	275	2	1	329	23.0
200	310	99	2.1	1.1	ACT040BDB	255	702	2 000	2 600	229	313.0	240	293	2	1	421	29.5
220	340	108	3	1.1	ACT044BDB	299	858	1 800	2 400	278	342.9	263	321	2.5	1	566	38.5
240	360	108	3	1.1	ACT048BDB	308	914	1 600	2 200	298	359.7	283	343	2.5	1	605	41.1
260	400	123	4	1.5	ACT052BDB	381	1 210	1 500	1 900	393	399.9	310	379	3	1.5	866	60.5
280	420	123	4	1.5	ACT056BDB	393	1 290	1 400	1 800	421	416.7	330	401	3	1.5	915	64.1
300	460	142.5	4	1.5	ACT060BDB	444	1 530	1 200	1 600	501	461.4	358	435	3	1.5	1 320	92.1
320	480	142.5	4	1.5	ACT064BDB	449	1 570	1 100	1 500	518	478.1	378	457	3	1.5	1 400	96.9

[Remark] This bearing is interchangeable with 234400B as their bore and outside diameters are the same.

4. Tapered Roller Bearings

Contents

	Page
4. 1 Types and features of tapered roller bearings.....	157
4. 2 Composition of bearing numbers.....	157
4. 3 Tolerance of tapered roller bearings.....	158
4. 4 Axial load and displacement.....	159
 ■ Bearing dimension tables	
· 32900JR series.....	160
· 32000JR series.....	162
· 30200JR series.....	164
· 32200JR series.....	166

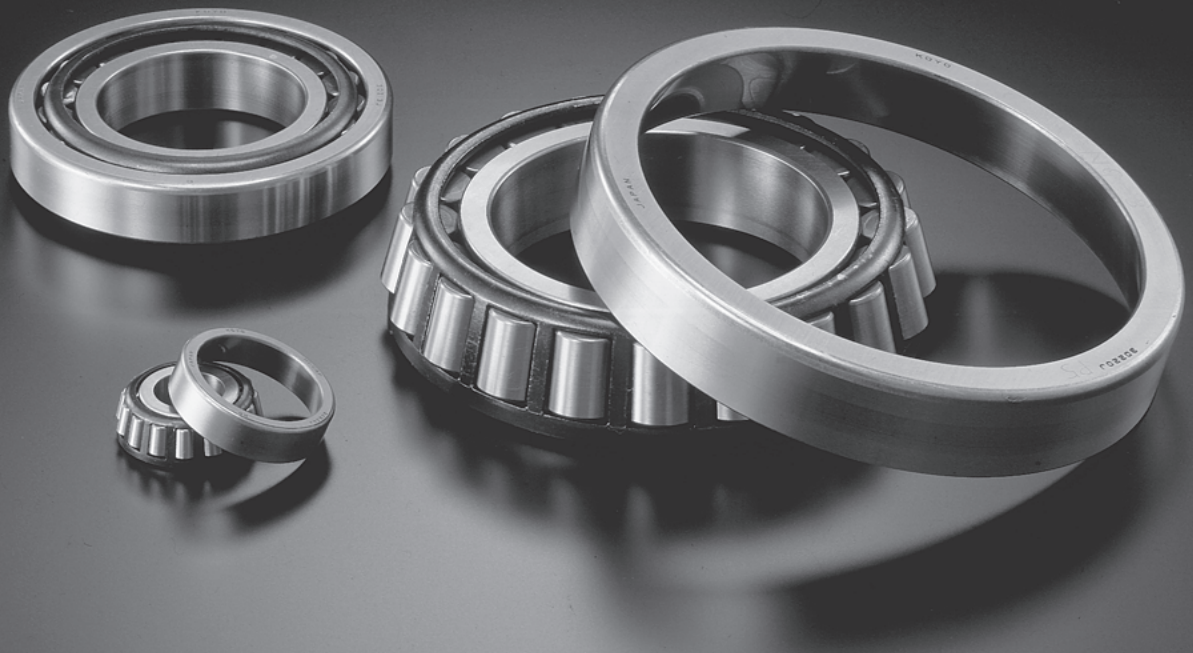

4. Tapered roller bearings

The tapered roller bearing is a bearing in which tapered rollers (truncated conical rollers) are inserted between the outer ring and inner ring. The rollers are guided by the inner ring back face rib (see Fig. 4. 1).

A radial load and an axial load can be simultaneously applied to the tapered roller bearing. This bearing has high rigidity.

In addition, tapered roller bearings allow easy adjustments of preload.

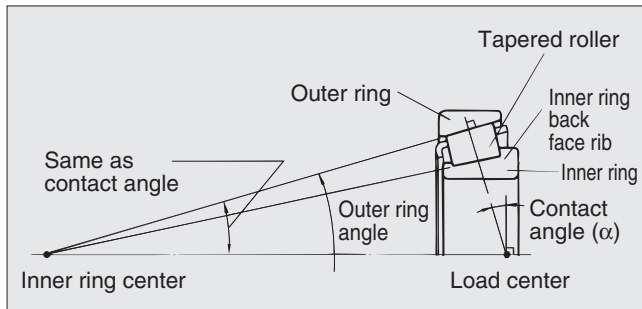

Fig. 4. 1 Structure of tapered roller bearing

Since the single row tapered roller bearing can receive only a unidirectional axial load, a pair of single row bearings are mounted apart and facing each other, or they are often used in a face-to-face or back-to-back arrangement.

4. 1 Types and features of tapered roller bearings

Two types of tapered roller bearings are available for machine tools: the single row tapered roller bearing (auxiliary symbol: JR) and the tapered roller bearing with flanged outer ring (auxiliary symbol: B) (see Table 4. 1).

Table 4. 1 Types and features of tapered roller bearings for machine tools

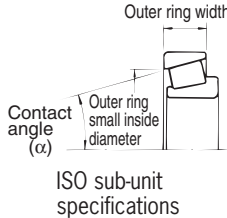
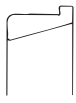
Types	Features
Tapered roller bearing with J designation 	Bearings whose basic numbers are followed by "J" are made to the ISO sub-unit specifications. Consequently, inner ring assemblies and outer rings, if given the same bearing number, are interchangeable on an international level. Reference: The symbol R denotes high load capacity bearings.
Tapered roller bearing with flanged outer ring 	This bearing allows easy positioning in axial direction using a simple housing structure.

4. 2 Composition of bearing numbers (metric series tapered roller bearings)

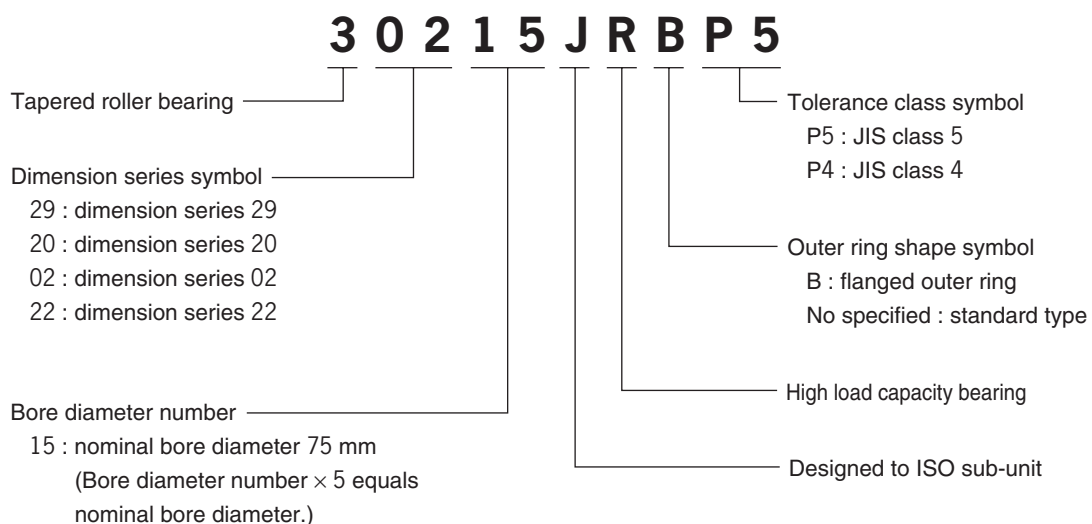

4. Tapered roller bearings

4.3 Tolerance of tapered roller bearings

The tolerance of the tapered roller bearing is compliant with permissible dimensional deviations and limits of classes 5 and 4 as specified in JIS B 1514 for tapered roller bearings.

Permissible dimensional deviations and limits to tapered roller bearings are shown in **Table 4. 2**.

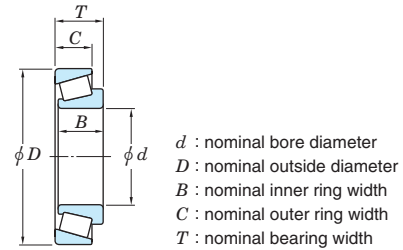

Table 4. 2 Permissible dimensional deviations and limits to metric tapered roller bearings

(1) Inner ring

Unit : μm

Nominal bore diameter d (mm)		Single plane mean bore diameter deviation Δ_{dmp}				Single bore diameter deviation Δ_{ds}		Single plane bore diameter variation V_{dsp}		Mean bore diameter variation V_{dmp}	
		Class 5		Class 4		Class 4		Class 5	Class 4	Class 5	Class 4
over	up to	upper	lower	upper	lower	upper	lower	max.		max.	
10	18	0	-7	0	-5	0	-5	5	4	5	4
18	30	0	-8	0	-6	0	-6	6	5	5	4
30	50	0	-10	0	-8	0	-8	8	6	5	5
50	80	0	-12	0	-9	0	-9	9	7	6	5
80	120	0	-15	0	-10	0	-10	11	8	8	5
120	180	0	-18	0	-13	0	-13	14	10	9	7

Nominal bore diameter d (mm)		Radial runout of assembled bearing inner ring K_{ia}		Face runout with bore S_d		Assembled bearing inner ring back face runout with raceway S_{ia}		Single inner ring width deviation Δ_{Bs}		Actual bearing width deviation Δ_{Ts}	
		Class 5	Class 4	Class 5	Class 4	Class 4		Classes 5, 4		Classes 5, 4	
over	up to	max.		max.		max.		upper	lower	upper	lower
10	18	5	3	7	3	3		0	-200	+200	-200
18	30	5	3	8	4	4		0	-200	+200	-200
30	50	6	4	8	4	4		0	-240	+200	-200
50	80	7	4	8	5	4		0	-300	+200	-200
80	120	8	5	9	5	5		0	-400	+200	-200
120	180	11	6	10	6	7		0	-500	+350	-250

(2) Outer ring

Unit : μm

Nominal outside diameter D (mm)		Single plane mean outside diameter deviation Δ_{Dmp}		Single outside diameter deviation Δ_{Ds}		Single radial plane outside diameter variation V_{Dsp}		Mean outside diameter variation V_{Dmp}		Radial runout of assembled bearing outer ring K_{ea}		Variation of outside surface generatrix inclination with face S_D		Assembled bearing outer ring back face runout with raceway S_{ea}		Single outer ring width deviation Δ_{Cs}	
		Class 5	Class 4	Class 4		Class 5	Class 4	Class 5	Class 4	Class 5	Class 4	Class 5	Class 4	Class 4	Classes 5, 4		
over	up to	upper	lower	upper	lower	max.		max.		max.		max.		max.	upper	lower	
18	30	0	-8	0	-6	0	-6	6	5	5	4	6	4	8	4	5	Same as tolerance Δ_{Bs}, d being that of the same bearing.
30	50	0	-9	0	-7	0	-7	7	5	5	5	7	5	8	4	5	
50	80	0	-11	0	-9	0	-9	8	7	6	5	8	5	8	4	5	
80	120	0	-13	0	-10	0	-10	10	8	7	5	10	6	9	5	6	
120	150	0	-15	0	-11	0	-11	11	8	8	6	11	7	10	5	7	
150	180	0	-18	0	-13	0	-13	14	10	9	7	13	8	10	5	8	
180	250	0	-20	0	-15	0	-15	15	11	10	8	15	10	11	7	10	
250	315	0	-25	0	-18	0	-18	19	14	13	9	18	11	13	8	10	

4. 4 Axial load and displacement (tapered roller bearings)

Fig 4. 2 shows relationships between axial load and displacement of KOYO tapered roller bearings.

(1) 32900JR series

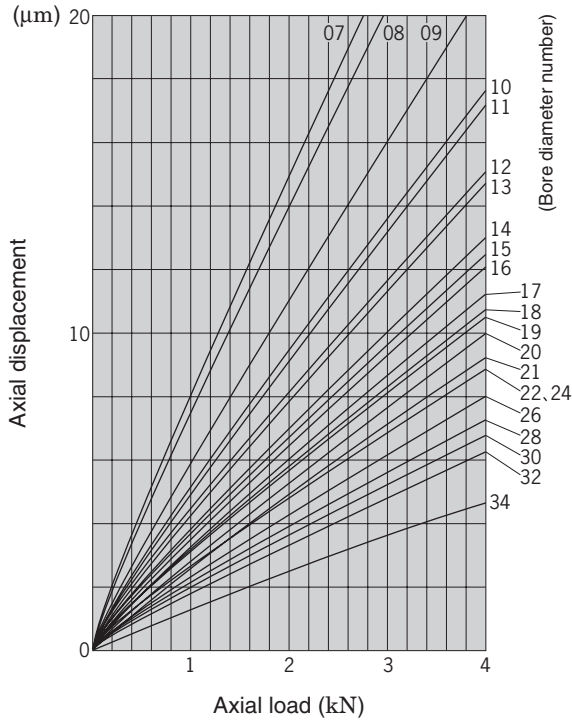

(2) 32000JR series

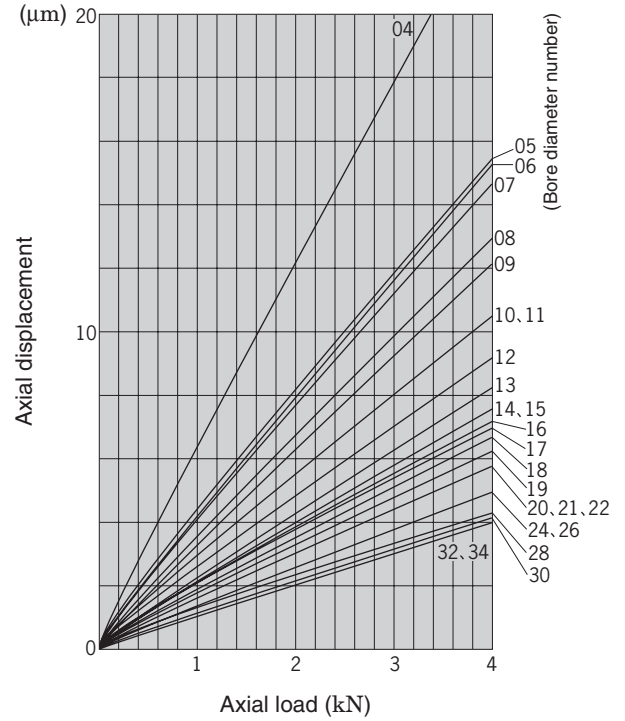

(3) 30200JR series

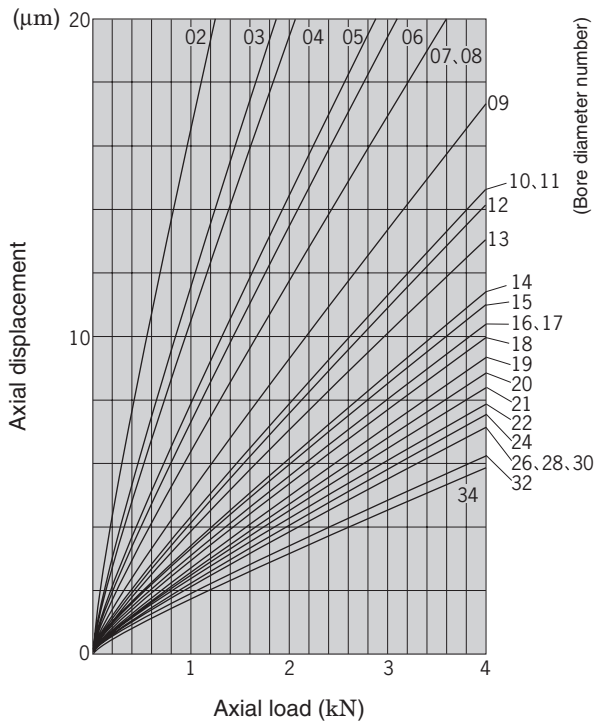

(4) 32200JR series

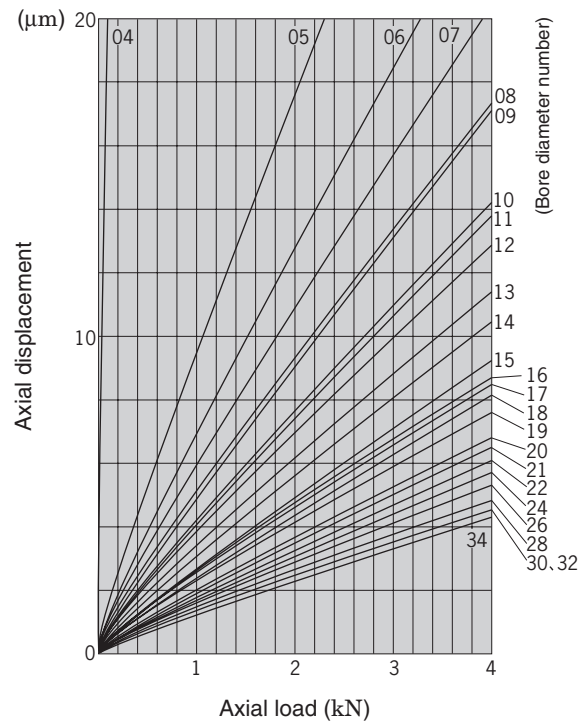
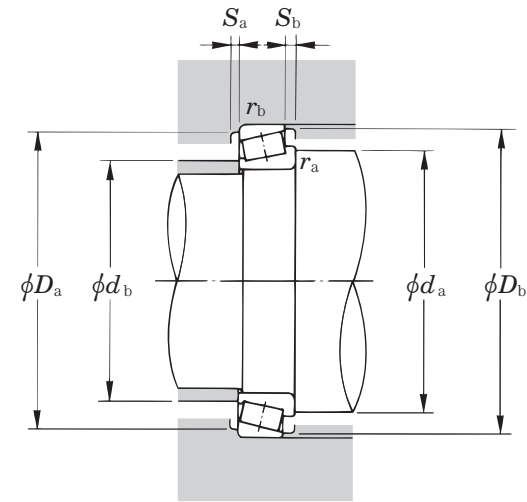
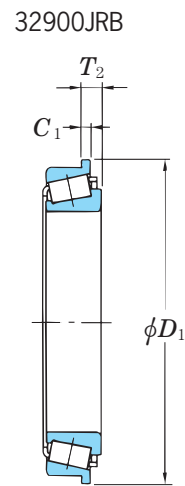
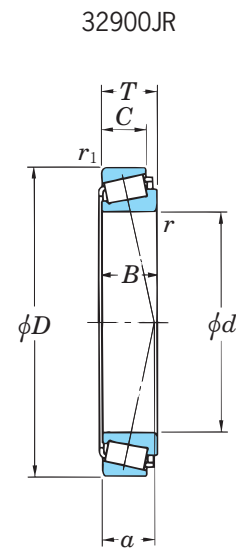

Fig. 4. 2 Relationships between axial load and displacement (tapered roller bearings)

*The axial displacements shown above are values of the single-row bearings not preloaded.

4. Tapered roller bearings

32900JR series



Dynamic equivalent load $P = XF_r + YF_a$

$\frac{F_a}{F_r} \leq e$		$\frac{F_a}{F_r} > e$	
X	Y	X	Y
1	0	0.4	Y_1

Static equivalent load $P_0 = 0.5F_r + Y_0F_a$

Note that if $P_0 < F_r$, it is assumed that $P_0 = F_r$.
For e , Y_1 , and Y_0 , use values given in the table.

d	Boundary dimensions (mm)						Bearing No.	Basic load ratings (kN)		Limiting speeds (min ⁻¹)		Load center (mm) a	Flange dimensions (mm)			Mounting dimensions (mm)								Constant e	Axial load coefficient		(Refer.) Mass (kg)		
	D	T	B	C	r min.	r ₁ min.		C _r	C _{0r}	Grease lub.	Oil lub.		D ₁	C ₁	T ₂	d _a min.	d _b max.	D _a max.	D _b min.	S _a min.	S _b min.	r _a max.	r _b max.		Y ₁	Y ₀			
35	55	14	14	11.5	0.6	0.6	32907JR-2	26.1	36.5	6 600	8 800	10.9		59	3	5.5	39.5	40	50.5	49	52	2.5	2.5	0.6	0.6	0.29	2.06	1.13	0.120
40	62	15	15	12	0.6	0.6	32908JR	33.5	48.5	5 900	7 800	11.9		66	3	6	44.5	45	57.5	55	59	3	3	0.6	0.6	0.29	2.07	1.14	0.164
45	68	15	15	12	0.6	0.6	32909JR	34.7	52.4	5 300	7 100	12.5		73	3	6	49.5	50	63.5	61	64	3	3	0.6	0.6	0.32	1.88	1.04	0.190
50	72	15	15	12	0.6	0.6	32910JR	35.9	56.3	4 900	6 600	13.7		77	3	6	54.5	55	67.5	65	69	3	3	0.6	0.6	0.34	1.76	0.97	0.195
55	80	17	17	14	1	1	32911JR	44.6	73.3	4 400	5 900	14.5		85	3	6	61	61	74	72	76	3	3	1	1	0.31	1.94	1.07	0.285
60	85	17	17	14	1	1	32912JR	46.2	78.2	4 100	5 500	15.6		90	3	6	65.5	66	79.5	77	81	3	3	1	1	0.33	1.81	1.00	0.306
65	90	17	17	14	1	1	32913JR	47.4	83.1	3 900	5 200	16.8		95	3	6	70.5	70	84.5	81	86	3	3	1	1	0.35	1.70	0.93	0.327
70	100	20	20	16	1	1	32914JR	71.0	115	3 500	4 700	17.8		105	3	7	75.5	77	94.5	91	96	4	4	1	1	0.32	1.90	1.05	0.496
75	105	20	20	16	1	1	32915JR	73.6	123	3 300	4 400	18.9		111	3	7	80.5	81	99.5	96	101	4	4	1	1	0.33	1.80	0.99	0.526
80	110	20	20	16	1	1	32916JR	76.1	131	3 100	4 200	20.1		116	3	7	85.5	86	104.5	101	106	4	4	1	1	0.35	1.71	0.94	0.556
85	120	23	23	18	1.5	1.5	32917JR	97.1	165	2 900	3 900	21.2		126	3	8	93.5	93	111.5	109	115	5	5	1.5	1.5	0.33	1.83	1.01	0.794
90	125	23	23	18	1.5	1.5	32918JR	101	175	2 800	3 700	22.3		131	3	8	98.5	97	116.5	114	120	5	5	1.5	1.5	0.34	1.75	0.96	0.834
95	130	23	23	18	1.5	1.5	32919JR	104	186	2 600	3 500	23.5		133	3	8	103.5	102	121.5	119	125	5	5	1.5	1.5	0.36	1.68	0.92	0.876
100	140	25	25	20	1.5	1.5	32920JR	126	217	2 400	3 300	24.0		147	4	9	108.5	108	131.5	128	135	5	5	1.5	1.5	0.33	1.82	1.00	1.19
105	145	25	25	20	1.5	1.5	32921JR	128	224	2 400	3 100	25.1		152	4	9	113.5	113	136.5	133	140	5	5	1.5	1.5	0.34	1.75	0.96	1.23
110	150	25	25	20	1.5	1.5	32922JR	129	231	2 300	3 000	26.3		157	4	9	118.5	118	141.5	138	145	5	5	1.5	1.5	0.36	1.69	0.93	1.28
120	165	29	29	23	1.5	1.5	32924JR	172	298	2 100	2 700	29.4		172	5	11	128.5	128	156.5	152	160	6	6	1.5	1.5	0.35	1.72	0.95	1.77
130	180	32	32	25	2	1.5	32926JR	200	368	1 900	2 500	31.4		187	5	12	140	141	171.5	165	174	6	7	2	1.5	0.34	1.77	0.97	2.42
140	190	32	32	25	2	1.5	32928JR	206	390	1 800	2 300	33.6		197	5	12	150	150	181.5	174	184	6	7	2	1.5	0.36	1.67	0.92	2.57
150	210	38	38	30	2.5	2	32930JR	286	536	1 600	2 100	36.1		218	6	14	162	163	200	194	202	7	8	2	2	0.33	1.83	1.01	3.96
160	220	38	38	30	2.5	2	32932JR	295	568	1 500	2 000	38.4		228	6	14	172	173	210	204	212	7	8	2	2	0.35	1.73	0.95	4.19
170	230	38	38	30	2.5	2	32934JR	296	606	1 400	1 900	42.0		238	6	14	182	183	220	213	222	7	8	2	2	0.38	1.57	0.86	4.49

[Note] 1) The bearing number of a tapered roller bearing with a flanged outer ring contains the auxiliary symbol B.
Example 32908JRB

4. Tapered roller bearings

32000JR series

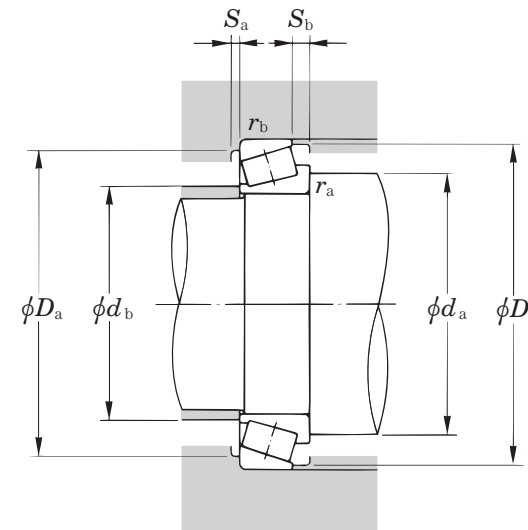
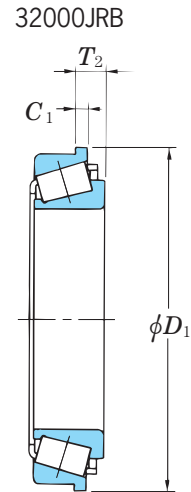
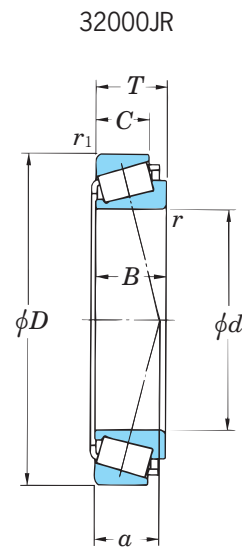

Dynamic equivalent load $P = XF_r + YF_a$

$\frac{F_a}{F_r} \leq e$		$\frac{F_a}{F_r} > e$	
X	Y	X	Y
1	0	0.4	Y_1

Static equivalent load $P_0 = 0.5F_r + Y_0F_a$

Note that if $P_0 < F_r$, it is assumed that $P_0 = F_r$.
For e , Y_1 , and Y_0 , use values given in the table.

d	Boundary dimensions (mm)						Bearing No.	Basic load ratings (kN)		Limiting speeds (min ⁻¹)		Load center (mm) a	Flange dimensions (mm)			Mounting dimensions (mm)								Constant e	Axial load coefficient		(Refer.) Mass (kg)	
	D	T	B	C	r min.	r1 min.		C _r	C _{0r}	Grease lub.	Oil lub.		D ₁	C ₁	T ₂	d _a min.	d _b max.	D _a max.	D _b min.	S _a min.	S _b min.	r _a max.	r _b max.		Y ₁	Y ₀		
20	42	15	15	12	0.6	0.6	32004JR	27.3	31.5	9 700	13 000	10.5	46	3	6	24.5	25	37.5	35	39	3	3	0.6	0.6	0.37	1.60	0.88	0.102
25	47	15	15	11.5	0.6	0.6	32005JR	30.2	37.7	8 300	11 000	11.8	51	3	6.5	29.5	30	42.5	40	44	3	3.5	0.6	0.6	0.43	1.39	0.77	0.118
30	55	17	17	13	1	1	32006JR	38.2	48.0	7 000	9 400	13.6	59	3	7	35.5	35	49.5	47	52	3	4	1	1	0.43	1.39	0.77	0.177
35	62	18	18	14	1	1	32007JR	45.5	59.4	6 200	8 200	15.1	66	3	7	40.5	40	56.5	54	59	4	4	1	1	0.45	1.32	0.73	0.231
40	68	19	19	14.5	1	1	32008JR	53.5	71.4	5 600	7 400	15.1	72	3.5	8	45.5	46	62.5	60	65	4	4.5	1	1	0.38	1.58	0.87	0.282
45	75	20	20	15.5	1	1	32009JR	62.8	86.5	5 000	6 600	16.5	79	3.5	8	50.5	51	69.5	67	72	4	4.5	1	1	0.39	1.53	0.84	0.354
50	80	20	20	15.5	1	1	32010JR	65.7	94.5	4 600	6 100	17.7	84	3.5	8	55.5	56	74.5	72	77	4	4.5	1	1	0.42	1.42	0.78	0.389
55	90	23	23	17.5	1.5	1.5	32011JR	84.6	121	4 100	5 500	19.8	94	4	9.5	63.5	63	81.5	81	86	4	5.5	1.5	1.5	0.41	1.48	0.81	0.569
60	95	23	23	17.5	1.5	1.5	32012JR	86.1	127	3 900	5 200	21.0	99	4	9.5	68.5	67	86.5	85	91	4	5.5	1.5	1.5	0.43	1.39	0.77	0.621
65	100	23	23	17.5	1.5	1.5	32013JR	90.0	137	3 600	4 800	22.5	104	4	9.5	73.5	72	91.5	90	97	4	5.5	1.5	1.5	0.46	1.31	0.72	0.664
70	110	25	25	19	1.5	1.5	32014JR	108	163	3 300	4 400	23.6	116	4.5	10.5	78.5	78	101.5	98	105	5	6	1.5	1.5	0.43	1.38	0.76	0.884
75	115	25	25	19	1.5	1.5	32015JR	110	169	3 100	4 200	25.1	121	4.5	10.5	83.5	83	106.5	103	110	5	6	1.5	1.5	0.46	1.31	0.72	0.930
80	125	29	29	22	1.5	1.5	32016JR	147	225	2 900	3 900	26.7	131	5	12	88.5	89	116.5	112	120	6	7	1.5	1.5	0.42	1.42	0.78	1.32
85	130	29	29	22	1.5	1.5	32017JR	150	234	2 800	3 700	28.0	136	5	12	93.5	94	121.5	117	125	6	7	1.5	1.5	0.44	1.36	0.75	1.38
90	140	32	32	24	2	1.5	32018JR	178	276	2 600	3 500	29.8	146	5.5	13.5	100	100	131.5	125	134	6	8	2	1.5	0.42	1.42	0.78	1.80
95	145	32	32	24	2	1.5	32019JR	182	287	2 500	3 300	31.2	151	5.5	13.5	105	105	136.5	130	140	6	8	2	1.5	0.44	1.36	0.75	1.88
100	150	32	32	24	2	1.5	32020JR	185	298	2 400	3 200	32.6	156	5.5	13.5	110	109	141.5	134	144	6	8	2	1.5	0.46	1.31	0.72	1.95
105	160	35	35	26	2.5	2	32021JR	215	344	2 200	3 000	34.5	168	6.5	15.5	117	116	150	143	154	6	9	2	2	0.44	1.35	0.74	2.45
110	170	38	38	29	2.5	2	32022JR	248	395	2 100	2 800	36.1	178	6.5	15.5	122	122	160	152	163	7	9	2	2	0.43	1.39	0.77	3.12
120	180	38	38	29	2.5	2	32024JR	258	427	2 000	2 600	38.8	188	6.5	15.5	132	131	170	161	173	7	9	2	2	0.46	1.31	0.72	3.34
130	200	45	45	34	2.5	2	32026JR	340	563	1 800	2 300	42.9	208	8	19	142	144	190	178	192	8	11	2	2	0.43	1.38	0.76	5.04
140	210	45	45	34	2.5	2	32028JR	346	585	1 700	2 200	45.6	218	8	19	152	153	200	187	202	8	11	2	2	0.46	1.31	0.72	5.28
150	225	48	48	36	3	2.5	32030JR	391	668	1 500	2 000	48.8	233	8.5	20.5	164	164	213	200	216	8	12	2.5	2	0.46	1.31	0.72	6.41
160	240	51	51	38	3	2.5	32032JR	440	758	1 400	1 900	52.1	248	9	22	174	175	228	213	231	8	13	2.5	2	0.46	1.31	0.72	7.75
170	260	57	57	43	3	2.5	32034JR	526	905	1 300	1 700	55.8	268	10	24	184	187	248	230	249	10	14	2.5	2	0.44	1.35	0.74	10.5

[Note] 1) The bearing number of a tapered roller bearing with a flanged outer ring contains the auxiliary symbol B.
Example 32004JRB

4. Tapered roller bearings

30200JR series

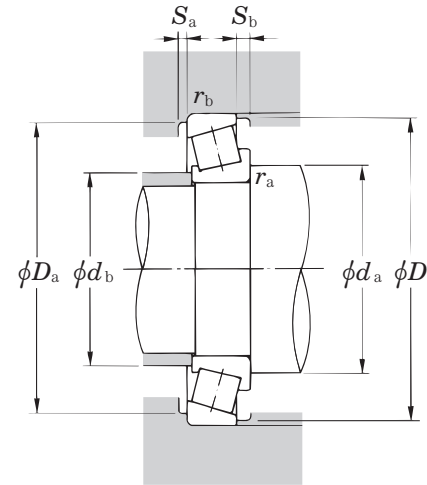
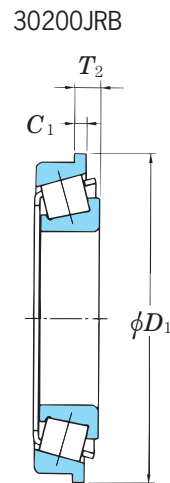
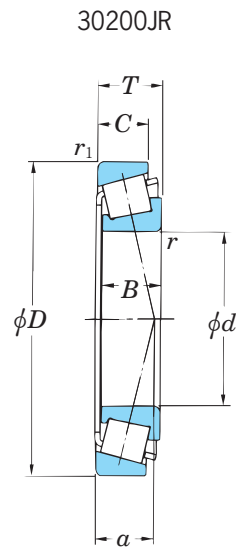

Dynamic equivalent load $P = XF_r + YF_a$

$\frac{F_a}{F_r} \leq e$		$\frac{F_a}{F_r} > e$	
X	Y	X	Y
1	0	0.4	Y_1

Static equivalent load $P_0 = 0.5F_r + Y_0F_a$

Note that if $P_0 < F_r$, it is assumed that $P_0 = F_r$.
For e , Y_1 , and Y_0 , use values given in the table.

d	Boundary dimensions (mm)						Bearing No.	Basic load ratings (kN)		Limiting speeds (min ⁻¹)		Load center (mm) a	Flange dimensions (mm)			Mounting dimensions (mm)								Constant e	Axial load coefficient		(Refer.) Mass (kg)	
	D	T	B	C	r min.	r ₁ min.		C _r	C _{0r}	Grease lub.	Oil lub.		D ₁	C ₁	T ₂	d _a min.	d _b max.	D _a max.	D _b min.	S _a min.	S _b min.	r _a max.	r _b max.		Y ₁	Y ₀		
17	40	13.25	12	11	1	1	30203JR	20.8	20.7	10 000	14 000	10.1	44	3	5.25	22.5	23	34.5	33	37	2	2	1	1	0.35	1.74	0.96	0.081
20	47	15.25	14	12	1	1	30204JR	27.0	27.2	8 700	12 000	11.8	51	3	6.25	25.5	27	41.5	39	44	2	3	1	1	0.35	1.74	0.96	0.127
25	52	16.25	15	13	1	1	30205JR	31.5	33.7	7 800	10 000	12.9	57	3.5	6.75	30.5	31	46.5	44	48	2	3	1	1	0.37	1.60	0.88	0.156
30	62	17.25	16	14	1	1	30206JR	41.5	44.8	6 500	8 700	14.1	67	3.5	6.75	35.5	37	56.5	53	57	2	3	1	1	0.37	1.60	0.88	0.236
35	72	18.25	17	15	1.5	1.5	30207JR	55.1	60.9	5 600	7 400	15.3	77	4	7.25	43.5	44	63.5	62	67	3	3	1.5	1.5	0.37	1.60	0.88	0.344
40	80	19.75	18	16	1.5	1.5	30208JR	62.9	69.2	5 000	6 700	17.0	85	4	7.75	48.5	49	71.5	69	75	3	3.5	1.5	1.5	0.37	1.60	0.88	0.434
45	85	20.75	19	16	1.5	1.5	30209JR	67.2	77.4	4 600	6 100	18.9	90	4	8.75	53.5	54	76.5	74	80	3	4.5	1.5	1.5	0.40	1.48	0.81	0.502
50	90	21.75	20	17	1.5	1.5	30210JR	76.5	91.7	4 300	5 700	20.1	95	4	8.75	58.5	58	81.5	79	85	3	4.5	1.5	1.5	0.42	1.43	0.79	0.566
55	100	22.75	21	18	2	1.5	30211JR	94.6	113	3 900	5 200	20.7	106	4.5	9.25	65	64	90	88	94	4	4.5	2	1.5	0.40	1.48	0.81	0.732
60	110	23.75	22	19	2	1.5	30212JR	106	127	3 500	4 700	21.9	116	4.5	9.25	70	70	100	96	103	4	4.5	2	1.5	0.40	1.48	0.81	0.945
65	120	24.75	23	20	2	1.5	30213JR	128	156	3 200	4 300	24.2	127	4.5	9.25	75	77	110	106	113	4	4.5	2	1.5	0.40	1.48	0.81	1.18
70	125	26.25	24	21	2	1.5	30214JR	138	173	3 100	4 100	25.9	132	5	10.25	80	81	116.5	110	118	4	5	2	1.5	0.42	1.43	0.79	1.32
75	130	27.25	25	22	2	1.5	30215JR	142	181	2 900	3 900	27.6	137	5	10.25	85	86	121.5	115	124	4	5	2	1.5	0.44	1.38	0.76	1.42
80	140	28.25	26	22	2.5	2	30216JR	161	202	2 700	3 600	28.6	147	5	11.25	92	91	130	124	132	4	6	2	2	0.42	1.43	0.79	1.72
85	150	30.5	28	24	2.5	2	30217JR	182	231	2 500	3 400	30.4	158	5	11.5	97	97	140	132	141	5	6.5	2	2	0.42	1.43	0.79	2.17
90	160	32.5	30	26	2.5	2	30218JR	204	261	2 400	3 200	32.6	168	6	12.5	102	103	150	140	150	5	6.5	2	2	0.42	1.43	0.79	2.65
95	170	34.5	32	27	3	2.5	30219JR	231	299	2 200	3 000	34.9	179	6.5	14	109	110	158	149	159	5	7.5	2.5	2	0.42	1.43	0.79	3.20
100	180	37	34	29	3	2.5	30220JR	258	338	2 100	2 800	36.8	190	7	15	114	116	168	157	168	5	8	2.5	2	0.42	1.43	0.79	3.83
105	190	39	36	30	3	2.5	30221JR	288	380	2 000	2 600	39.0	200	7	16	119	122	178	165	178	6	9	2.5	2	0.42	1.43	0.79	4.49
110	200	41	38	32	3	2.5	30222JR	324	434	1 900	2 500	40.8	210	7	16	124	129	188	174	188	6	9	2.5	2	0.42	1.43	0.79	5.33
120	215	43.5	40	34	3	2.5	30224JR	347	473	1 700	2 300	44.2	225	8	17.5	134	140	203	187	203	6	9.5	2.5	2	0.44	1.38	0.76	6.36
130	230	43.75	40	34	4	3	30226JR	377	511	1 600	2 100	46.2	241	8	17.75	148	152	216	203	218	7	9.5	3	2.5	0.44	1.38	0.76	7.24
140	250	45.75	42	36	4	3	30228JR	420	570	1 500	1 900	49.4	261	9	18.75	158	163	236	219	237	9	9.5	3	2.5	0.44	1.38	0.76	8.97
150	270	49	45	38	4	3	30230JR	483	664	1 300	1 800	52.4	282	9	20	168	175	256	234	255	9	11	3	2.5	0.44	1.38	0.76	11.6
160	290	52	48	40	4	3	30232JR	542	750	1 200	1 600	56.3	302	11	23	178	189	276	252	269	8	12	3	2.5	0.44	1.38	0.76	14.1
170	310	57	52	43	5	4	30234JR	620	867	1 100	1 500	61.2	322	11	25	192	202	292	269	288	8	14	4	3	0.44	1.38	0.76	17.8

[Note] 1) The bearing number of a tapered roller bearing with a flanged outer ring contains the auxiliary symbol B.
Example 30203JRB

4. Tapered roller bearings

32200JR series

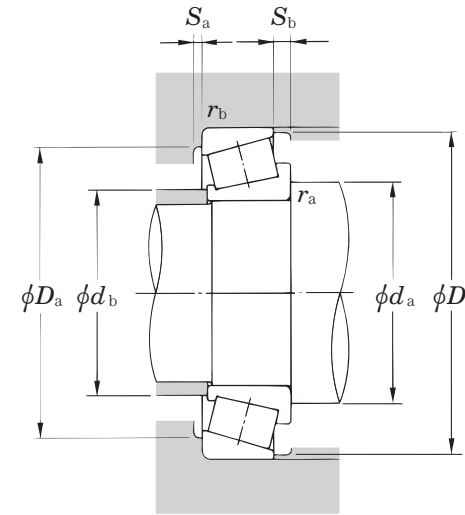
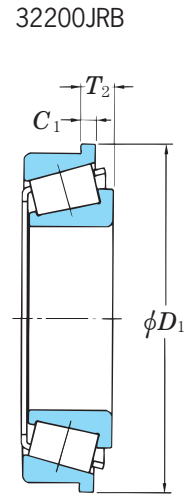
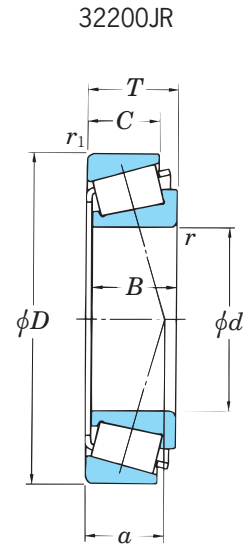

Dynamic equivalent load $P = XF_r + YF_a$

$\frac{F_a}{F_r} \leq e$		$\frac{F_a}{F_r} > e$	
X	Y	X	Y
1	0	0.4	Y_1

Static equivalent load $P_0 = 0.5F_r + Y_0F_a$

Note that if $P_0 < F_r$, it is assumed that $P_0 = F_r$.
For e , Y_1 , and Y_0 , use values given in the table.

d	Boundary dimensions (mm)						Bearing No.	Basic load ratings (kN)		Limiting speeds (min ⁻¹)		Load center (mm) a	Flange dimensions (mm)			Mounting dimensions (mm)								Constant e	Axial load coefficient		(Refer.) Mass (kg)	
	D	T	B	C	r min.	r ₁ min.		C _r	C _{0r}	Grease lub.	Oil lub.		D ₁	C ₁	T ₂	d _a min.	d _b max.	D _a max.	D _b min.	S _a min.	S _b min.	r _a max.	r _b max.		Y ₁	Y ₀		
20	47	19.25	18	15	1	1	32204JR	33.1	34.7	8 900	12 000	12.5	51	3	7.25	25.5	27	41.5	39	43	2	4	1	1	0.33	1.81	1.00	0.159
25	52	19.25	18	16	1	1	32205JR	39.8	44.8	7 900	11 000	13.5	57	3.5	6.75	30.5	31	46.5	43	48	2	4	1	1	0.36	1.67	0.92	0.188
30	62	21.25	20	17	1	1	32206JR	50.7	57.9	6 500	8 700	15.9	67	4	8.25	35.5	37	56.5	52	58	2	4	1	1	0.37	1.60	0.88	0.292
35	72	24.25	23	19	1.5	1.5	32207JR	69.6	82.4	5 600	7 500	18.2	77	4.5	9.75	43.5	43	63.5	61	67	3	5	1.5	1.5	0.37	1.60	0.88	0.453
40	80	24.75	23	19	1.5	1.5	32208JR	77.7	90.8	5 000	6 600	19.4	85	4.5	10.25	48.5	48	71.5	68	75	3	5.5	1.5	1.5	0.37	1.60	0.88	0.554
45	85	24.75	23	19	1.5	1.5	32209JR-1	84.2	104	4 600	6 100	20.3	90	4.5	10.25	53.5	53	76.5	73	81	3	5.5	1.5	1.5	0.40	1.48	0.81	0.597
50	90	24.75	23	19	1.5	1.5	32210JR	85.0	105	4 300	5 700	20.6	95	4.5	10.25	58.5	58	81.5	78	85	3	5.5	1.5	1.5	0.42	1.43	0.79	0.643
55	100	26.75	25	21	2	1.5	32211JR-1	107	133	3 900	5 200	23.0	106	5	10.75	65	63	90	87	95	4	5.5	2	1.5	0.40	1.48	0.81	0.863
60	110	29.75	28	24	2	1.5	32212JR	132	167	3 500	4 700	25.1	116	5	10.75	70	69	100	95	104	4	5.5	2	1.5	0.40	1.48	0.81	1.19
65	120	32.75	31	27	2	1.5	32213JR	157	203	3 200	4 300	26.6	127	6	11.75	75	76	110	104	115	4	5.5	2	1.5	0.40	1.48	0.81	1.58
70	125	33.25	31	27	2	1.5	32214JR	169	225	3 100	4 100	29.2	132	6	12.25	80	80	116.5	108	119	4	6	2	1.5	0.42	1.43	0.79	1.71
75	130	33.25	31	27	2	1.5	32215JR	174	234	2 900	3 900	30.2	137	6	12.25	85	85	121.5	114	125	4	6	2	1.5	0.44	1.38	0.76	1.77
80	140	35.25	33	28	2.5	2	32216JR	203	271	2 700	3 600	31.7	147	6	13.25	92	90	130	122	134	4	7	2	2	0.42	1.43	0.79	2.17
85	150	38.5	36	30	2.5	2	32217JR	232	315	2 500	3 400	34.2	158	7	15.5	97	96	140	130	142	5	8.5	2	2	0.42	1.43	0.79	2.80
90	160	42.5	40	34	2.5	2	32218JR	263	362	2 400	3 200	37.0	168	8	16.5	102	102	150	138	152	5	8.5	2	2	0.42	1.43	0.79	3.47
95	170	45.5	43	37	3	2.5	32219JR	311	439	2 200	3 000	38.9	179	8	16.5	109	108	158	145	161	5	8.5	2.5	2	0.42	1.43	0.79	4.34
100	180	49	46	39	3	2.5	32220JR	347	495	2 100	2 800	42.1	190	8	18	114	114	168	154	171	5	10	2.5	2	0.42	1.43	0.79	5.21
105	190	53	50	43	3	2.5	32221JR	392	567	2 000	2 700	44.8	200	9	19	119	120	178	161	180	6	10	2.5	2	0.42	1.43	0.79	6.37
110	200	56	53	46	3	2.5	32222JR	438	640	1 900	2 500	46.7	210	10	20	124	126	188	170	190	6	10	2.5	2	0.42	1.43	0.79	7.45
120	215	61.5	58	50	3	2.5	32224JR	470	691	1 700	2 300	51.6	225	11	22.5	134	136	203	181	204	7	11.5	2.5	2	0.44	1.38	0.76	9.04
130	230	67.75	64	54	4	3	32226JR	554	830	1 600	2 200	56.0	241	11	24.75	148	146	216	193	219	7	13.5	3	2.5	0.44	1.38	0.76	11.5
140	250	71.75	68	58	4	3	32228JR	636	961	1 500	2 000	60.0	261	12	25.75	158	158	236	210	238	9	13.5	3	2.5	0.44	1.38	0.76	14.7
150	270	77	73	60	4	3	32230JR	704	1 070	1 300	1 800	65.2	282	12	29	168	170	256	226	254	8	17	3	2.5	0.44	1.38	0.76	18.2
160	290	84	80	67	4	3	32232JR	795	1 210	1 200	1 700	70.3	304	14	31	178	182	276	242	274	10	17	3	2.5	0.44	1.38	0.76	23.2
170	310	91	86	71	5	4	32234JR	898	1 380	1 100	1 500	76.2	324	14	34	192	195	292	259	294	10	20	4	3	0.44	1.38	0.76	28.9

[Note] 1) The bearing number of a tapered roller bearing with a flanged outer ring contains the auxiliary symbol B.
Example 32204JRB

5. Support Bearings and Support Bearing Units for Precision Ball Screws

Contents

	Page
5. 1 Structure and features	171
5. 2 Composition of identification numbers	173
5. 3 Tolerance of support bearings for precision ball screws.....	174
5. 4 Axial load and displacement	174
 ■ Bearing and bearing unit dimension tables	
· SAC0000 and SAC00000 series.....	176
· BSU0000BDF(DFD, DFF) series.....	178
· BSU0000BDF(DFD, DFF) -T series	180



5. Support bearings and support bearing units for precision ball screws

5.1 Structure and features

Support bearings for precision ball screws

The SAC type support bearings are angular contact thrust ball bearings specifically for supporting the screw shafts of precision ball screws (see Fig. 5. 1).

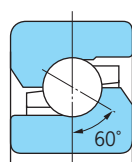

The bearings supporting the precision ball screws correspond to the type with contact seal.

Consult JTEKT for details about the type with contact seal and the pair patterns.

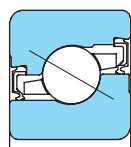

Both-side sealed type

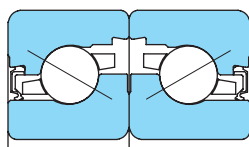

Matching example of one-side sealed type

Fig. 5. 1 Structure of support bearings for precision ball screws

These bearings have many, small-diameter balls and thick section inner and outer rings.

The contact angle of these bearings is 60° enabling a high axial load and a certain degree of radial load to be applied simultaneously.

1) Features of support bearings for precision ball screws

- High rigidity
Has higher rigidity against axial load than conventional standard bearings (see Fig. 5. 2).
- Compact and lightweight
Since this bearing eliminates the need for an additional radial bearing or thrust bearing, it allows a compact surrounding design, thereby contributing to a reduction in the weight of the total system.
- High precision
A high-precision bearing suitable for precision ball screws.
- Preload adjustments not required
Preload is preadjusted to ensure an adequate preload after mounting. As a result, complicated adjustments are not required during mounting.
- Low torque
Requires lower friction torque than the tapered roller bearing or thrust roller bearing.

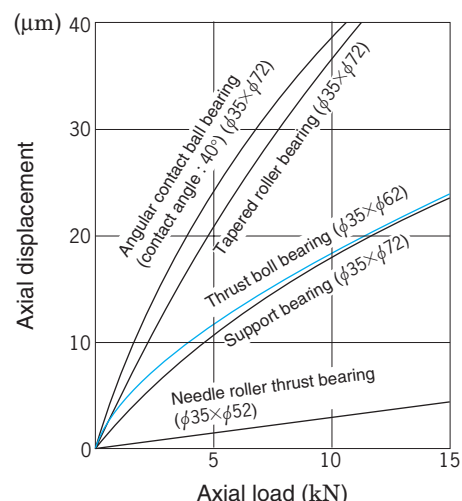

Fig. 5. 2 Relationship between axial load and displacement (comparison between support bearings and other bearings)

*The axial displacements shown above are values of the single-row bearings not preloaded.

2) Matched pair or stack support bearings

Table 5. 1 Types and suffixes of support bearings

Type and suffix of support bearing	
Combination of two	<p>Suffix DB Suffix DF</p>
Combination of three	<p>Suffix DFD</p>
Combination of four	<p>Suffix DFF</p>

- [Remarks] 1. A "V" mark is put on the outside surfaces of the outer rings of matched pair and stack bearings to indicate their combination type. For handling precautions of the type G bearing, refer to the bearing dimension table "1. 2 Matched pair angular contact ball bearings."
2. Type G bearings are also manufactured, which enable any desired combinations. For descriptions of the type G bearing, refer to the bearing dimension table "1. 2 Matched pair angular contact ball bearings."

Support bearing units for precision ball screws

The support bearing unit for precision ball screws is a unit product combining the SAC type support bearing and a housing machined to a high precision.

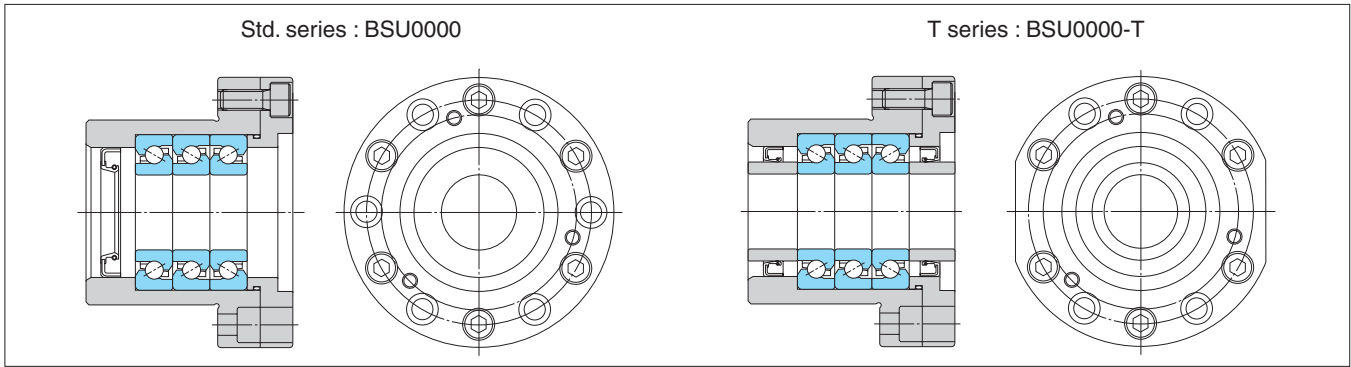

Fig. 5. 3 Series and structures of support bearing units for precision ball screws

1) Types of matched pair or stack bearing

Table 5. 2 Types of matched pair or stack bearing

Type and symbol	
Combination of two bearings	<p>(Suffix : DF)</p>
Combination of three bearings	<p>(Suffix : DFD)</p>
Combination of four bearings	<p>(Suffix : DFF)</p>

2) Features of support bearing units for precision ball screws

- Simple mounting work
This is a unit product consisting of a bearing where the preload is adjusted and an adequate quantity of grease is sealed within the bearing, and is mounted in a compact housing.
Thus the support bearing unit can be easily mounted on a machine.
- Excellent dust-proof performance
Having a high-performance built in oil seal the support bearing unit, with low torque operation, is excellent in dust-proof performance.
- Capability of coping with any desired design
In addition to the standard products listed in the dimension tables, **JTEKT** manufactures support bearing units to meet the support structures of various ball screws.
Consult **JTEKT** for more information.

5.2 Composition of identification numbers (support bearings and support bearing units for precision ball screws)

Support bearings for precision ball screws

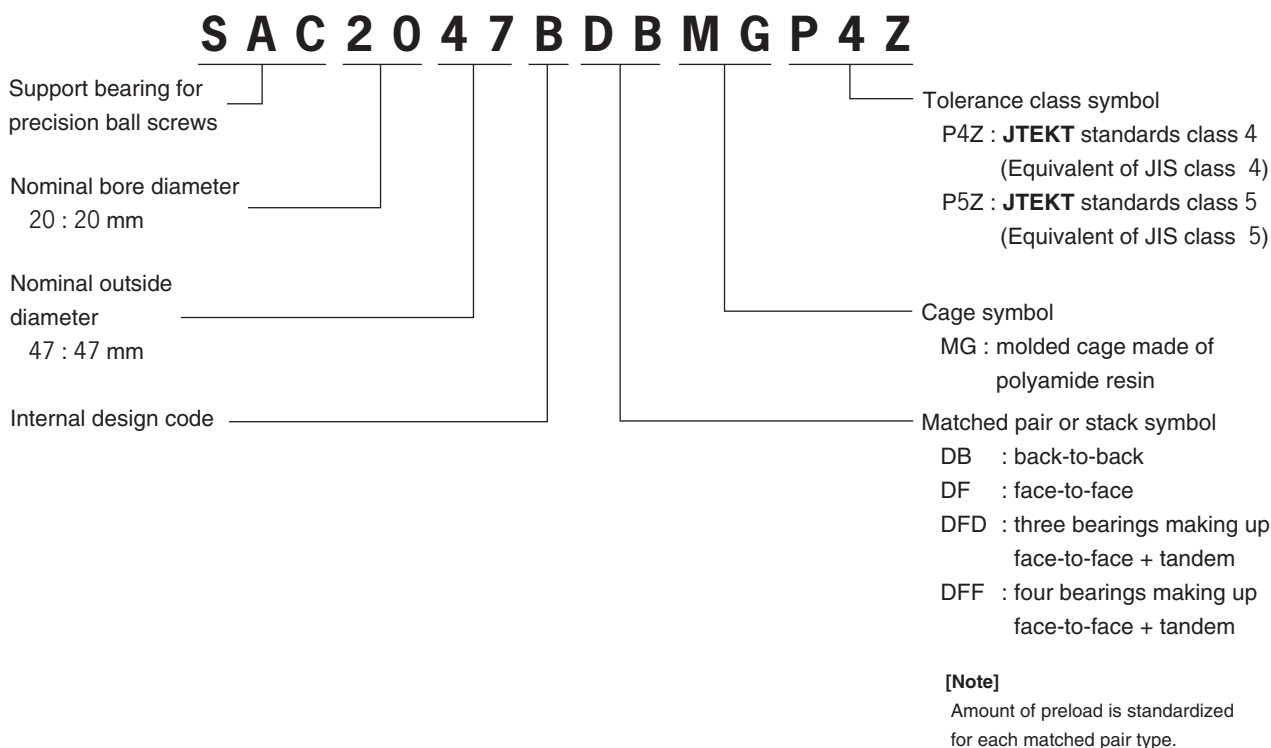

Support bearing units for precision ball screws

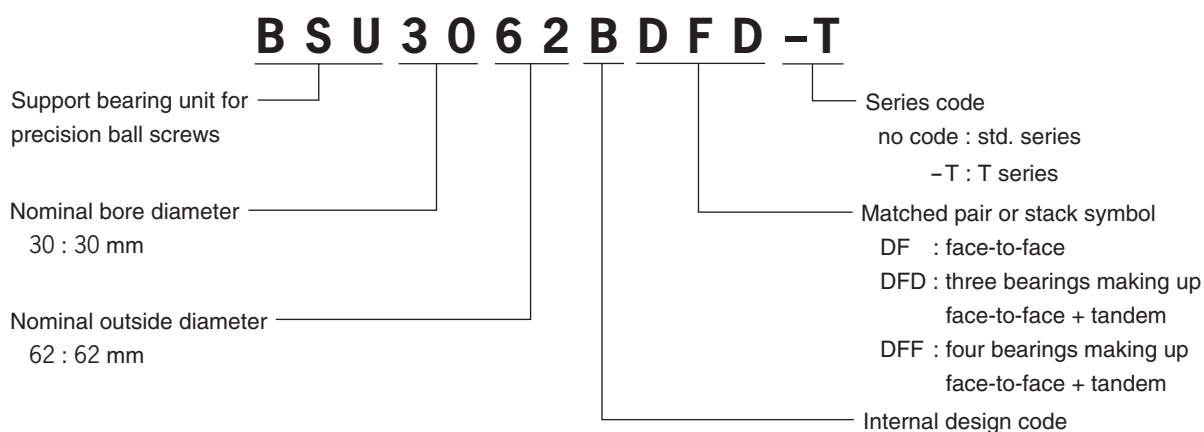

5. Support bearings and support bearing units for precision ball screws

5.3 Tolerance of support bearings for precision ball screws

The support bearings for precision ball screws are manufactured to specific **JTEKT** standards suitable for

the requirements of precision ball screws (see **Table 5.3**).

Table 5.3 Permissible dimensional deviations and limits of support bearings for precision ball screws

(1) Inner ring

Unit : μm

Nominal bore diameter d (mm)		Single plane mean bore diameter deviation Δd_{mp}				Single bore diameter deviation Δd_s				Single inner ring width deviation ΔB_s		Inner ring width variation V_{B_s}		K_{ia}		Perpendicularity of inner ring face with respect to the bore S_d		S_{ia}	
		Class 5Z		Class 4Z		Class 5Z		Class 4Z		Classes 5Z, 4Z		Class 5Z	Class 4Z	Class 5Z	Class 4Z	Class 5Z	Class 4Z	Class 5Z	Class 4Z
over	up to	upper	lower	upper	lower	upper	lower	upper	lower	upper	lower	max.		max.		max.		max.	
10	18	0	-5	0	-4	0	-5	0	-4	0	-80	5	2.5	4	2.5	7	3	5	3
18	30	0	-6	0	-5	0	-6	0	-5	0	-120	5	2.5	4	3	8	4	5	3
30	50	0	-8	0	-6	0	-8	0	-6	0	-120	5	3	5	4	8	4	6	3
50	80	0	-9	0	-7	0	-9	0	-7	0	-150	6	4	5	4	8	5	7	4

K_{ia} : Radial runout of assembled bearing inner ring

S_{ia} : Axial runout of assembled bearing inner ring

(2) Outer ring

Unit : μm

Nominal outside diameter D (mm)		Single plane mean outside diameter deviation ΔD_{mp}				Single outside diameter deviation ΔD_s				Deviation of a single outer ring width ΔC_s		Ring width variation V_{C_s}		K_{ea}		S_D		S_{ea}	
		Class 5Z		Class 4Z		Class 5Z		Class 4Z		Classes 5Z, 4Z		Class 5Z	Class 4Z	Class 5Z	Class 4Z	Class 5Z	Class 4Z	Class 5Z	Class 4Z
over	up to	upper	lower	upper	lower	upper	lower	upper	lower	upper	lower	max.		max.		max.		max.	
30	50	0	-7	0	-6	0	-7	0	-6	Same as tolerance ΔB_s , d being that of the same bearing.		5	2.5	7	5	8	4	Same as tolerance S_{ia} , d being that of the same bearing.	
50	80	0	-9	0	-7	0	-9	0	-7			6	3	8	5	8	4		
80	120	0	-10	0	-8	0	-10	0	-8			8	4	10	6	9	5		

K_{ea} : Radial runout of assembled bearing outer ring

S_D : Perpendicularity of outer ring surface with respect to the face

S_{ea} : Axial runout of assembled bearing outer ring

5.4 Axial load and displacement (support bearings for precision ball screws)

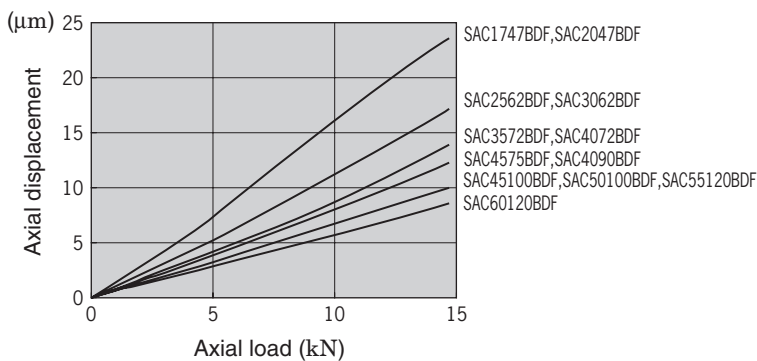

(Matched pair, standard preload)

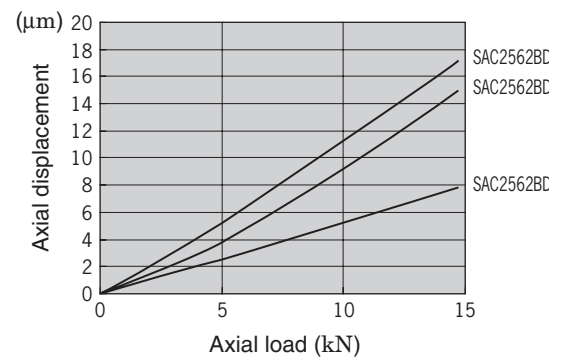

(Comparison of number of bearing rows)

Fig. 5.4 Relationship between axial load and displacement (support bearings for precision ball screws)

5. Support bearings and support bearing units for precision ball screws

SAC0000, SAC00000 series

Contact angle 60°

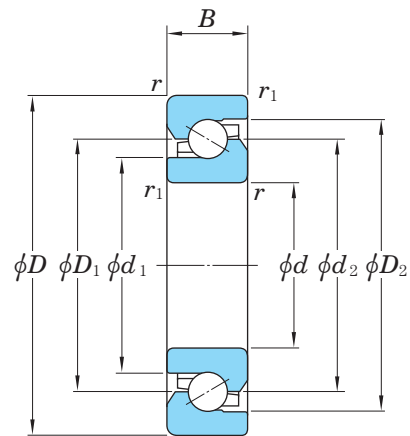

Two-bearing combination

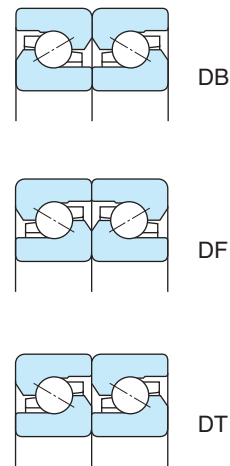

Three-bearing combination

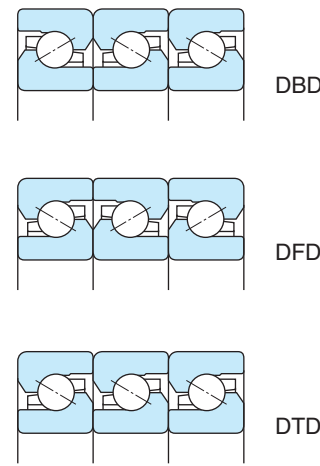

Four-bearing combination

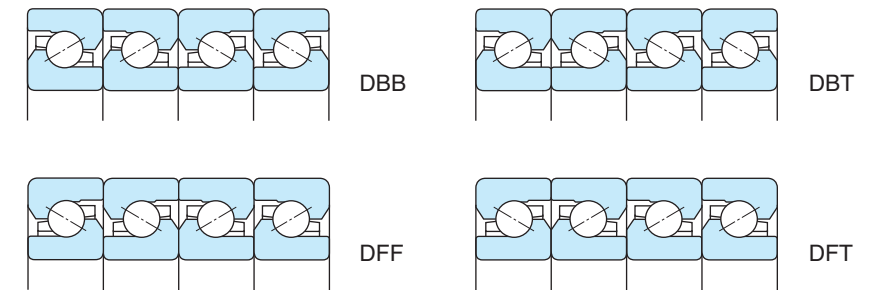

d	Boundary dimensions (mm)				Basic dynamic load ratings (kN) C_a	Max. axial loads (kN)			Limiting speeds (min ⁻¹)		Bearing ²⁾ No.	Interspace volume (cm ³ /row)	Dimensions (mm)				Standard preloads (kN)			Starting torques (mN·m)			Axial spring constants (N/μm)			(Refer.) Mass (kg/row)	
	D	B	r min.	r ₁ min.		Single row	Double row	Triple row	Grease lub.	Oil lub.			d ₁	d ₂	D ₁	D ₂	Two bearings	Three bearings	Four bearings	Two bearings	Three bearings	Four bearings	Two bearings	Three bearings	Four bearings		
17	47	15	1	0.6	26.0	34.3	68.6	103	6 300	8 000	SAC1747B	3.7		25.5	33.7	33.5	41	2.15	2.92	4.30	140	180	280	695	1 030	1 390	0.13
20	47	15	1	0.6	26.0	34.3	68.6	103	6 300	8 000	SAC2047B	3.7		26.8	33.7	33.5	41	2.15	2.92	4.30	140	180	280	695	1 030	1 390	0.12
25	62		1	0.6	30.2	48.1	96.2	144	4 600	6 000	SAC2562B	4.9		38	46.2	46	53.5	3.04	4.13	6.08	200	260	400	970	1 440	1 940	0.24
30	62	15	1	0.6	30.2	48.1	96.2	144	4 600	6 000	SAC3062B	4.9		38	46.2	46	53.5	3.04	4.13	6.08	200	260	400	970	1 440	1 940	0.21
35	72	15	1	0.6	32.8	58.8	118	176	3 700	5 000	SAC3572B	6.2		48	56.3	55.9	63.5	3.73	5.07	7.46	240	320	480	1 180	1 760	2 360	0.29
40	72	15	1	0.6	32.8	58.8	118	176	3 700	4 800	SAC4072B	6.2		48	56.3	55.9	63.5	3.73	5.07	7.46	240	320	480	1 180	1 760	2 360	0.26
	90	20	1	0.6	65.4	122	244	366	3 100	4 000	SAC4090B	15		54.5	67.5	66.8	78.5	5.00	6.80	10.0	440	610	880	1 270	1 890	2 540	0.62
45	75	15	1	0.6	34.0	64.4	129	193	3 400	4 300	SAC4575B	6.9		54	61.7	61.5	69	3.89	5.29	7.78	250	330	500	1 270	1 890	2 540	0.25
	100	20	1	0.6	68.8	137	274	411	2 800	3 600	SAC45100B	16		61.5	74.2	74	85.5	5.95	8.09	11.9	540	730	1 080	1 450	2 150	2 900	0.79
50	100	20	1	0.6	70.3	144	288	432	2 700	3 400	SAC50100B	17		65.8	78.2	78	89.5	6.00	8.15	12.0	540	730	1 080	1 500	2 230	3 000	0.65
55	120	20	1	0.6	73.9	166	332	498	2 300	3 000	SAC55120B	20		79.5	92.2	92	103.6	7.08	9.62	14.2	640	860	1 280	1 740	2 590	3 480	1.15
60	120	20	1	0.6	73.9	166	332	498	2 300	3 000	SAC60120B	20		78.3	92.2	92	103.6	7.08	9.62	14.2	640	860	1 280	1 740	2 590	3 480	1.15

[Notes] 1) The value of the basic dynamic load rating of a single bearing is shown. For those of matched pair and stack bearings, see table below.

Dynamic equivalent load $P_a = X F_r + Y F_a$

Number of rows to receive axial load	Basic dynamic load rating	Sample combination (arrow indicates direction of load.)
Single row	C_a	
Double row	$C_a \times 1.625$	
Triple row	$C_a \times 2.16$	

2) The identification of a matched bearing is composed of the bearing number of a single row bearing followed by the suffix (DB, DF, etc.).

Sample combination	Two bearings		Three bearings			Four bearings			
	DB DF	DT	DBD DFD	DTD	DBT DFT	DBB DFF	DBT DFT		
Number of rows to receive axial load	Single row	Double row	Single row	Double row	Triple row	Single row	Double row	Triple row	
$\frac{F_a}{F_r} \leq 2.17$	X	1.9	—	1.43	2.33	—	1.17	2.33	2.53
	Y	0.54	—	0.77	0.35	—	0.89	0.35	0.26
$\frac{F_a}{F_r} > 2.17$	X	0.92							
	Y	1							

BSU0000BDF(DFD, DFF) series

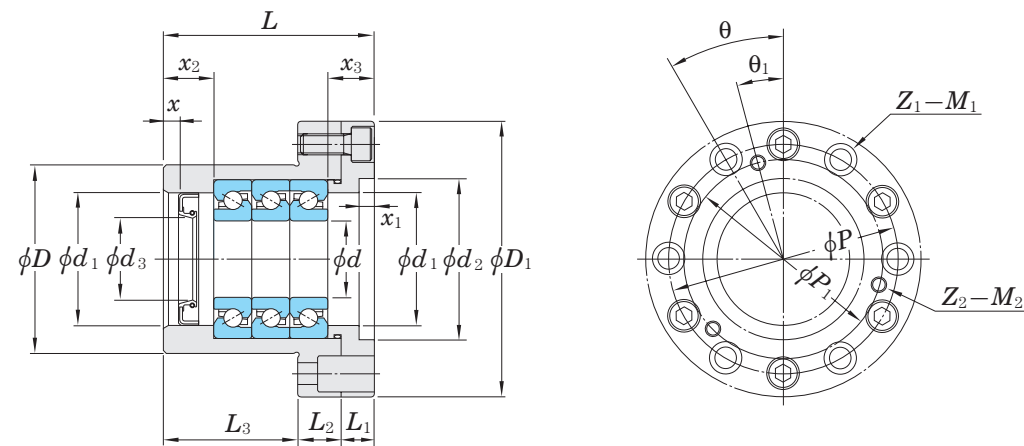

d	Dimensions (mm)												Applicable shaft dia. d ₃ (mm)	Unit identification number	Quantity of bearing	Mounting hole of housing			Tapped hole for Dust-proof cover/Damper			Standard preload (kN)	Starting torque (mN·m)	(Refer.) Mass (kg)
	D	D ₁	L	L ₁	L ₂	L ₃	d ₁	d ₂	x	x ₁	x ₂	x ₃				P (mm)	θ (°)	Z ₁ -M ₁ (No. of holes-threads)	P ₁ (mm)	θ ₁ (°)	Z ₂ -M ₂ (No. of holes-threads)			
17	60	90	65	15	15	35	38	47	6	6	15	20	28	BSU1747BDF	2	75	45	4 - M6	75	22.5	4 - M6	2.15	140	1.72
20	60	90	65	15	15	35	38	47	6	6	15	20	28	BSU2047BDF	2	75	45	4 - M6	75	22.5	4 - M6	2.15	140	1.70
25	74	108	68	13	17	38	52	63	6	6	20	18	32	BSU2562BDF	2	90	30	6 - M8	78	15	3 - M6	3.04	200	2.45
	74	108	83	13	17	53	52	63	6	6	20	18	32	BSU2562BDFD	3	90	30	6 - M8	78	15	3 - M6	4.13	260	2.85
30	74	108	68	13	17	38	52	63	6	6	20	18	40	BSU3062BDF	2	90	30	6 - M8	78	15	3 - M6	3.04	200	2.38
	74	108	83	13	17	53	52	63	6	6	20	18	40	BSU3062BDFD	3	90	30	6 - M8	78	15	3 - M6	4.13	260	2.74
35	84	118	68	13	17	38	60	73	6	6	20	18	45	BSU3572BDF	2	100	30	6 - M8	88	15	3 - M6	3.73	240	2.81
	84	118	83	13	17	53	60	73	6	6	20	18	45	BSU3572BDFD	3	100	30	6 - M8	88	15	3 - M6	5.07	320	3.28
	84	118	98	13	17	68	60	73	6	6	20	18	45	BSU3572BDFD	4	100	30	6 - M8	88	15	3 - M6	7.46	480	3.74
40	84	118	68	13	17	38	60	73	6	6	20	18	50	BSU4072BDF	2	100	30	6 - M8	88	15	3 - M6	3.73	240	2.77
	84	118	83	13	17	53	60	73	6	6	20	18	50	BSU4072BDFD	3	100	30	6 - M8	88	15	3 - M6	5.07	320	3.20
	84	118	98	13	17	68	60	73	6	6	20	18	50	BSU4072BDFD	4	100	30	6 - M8	88	15	3 - M6	7.46	480	3.64

BSU0000BDF(DFD, DFF) - T series

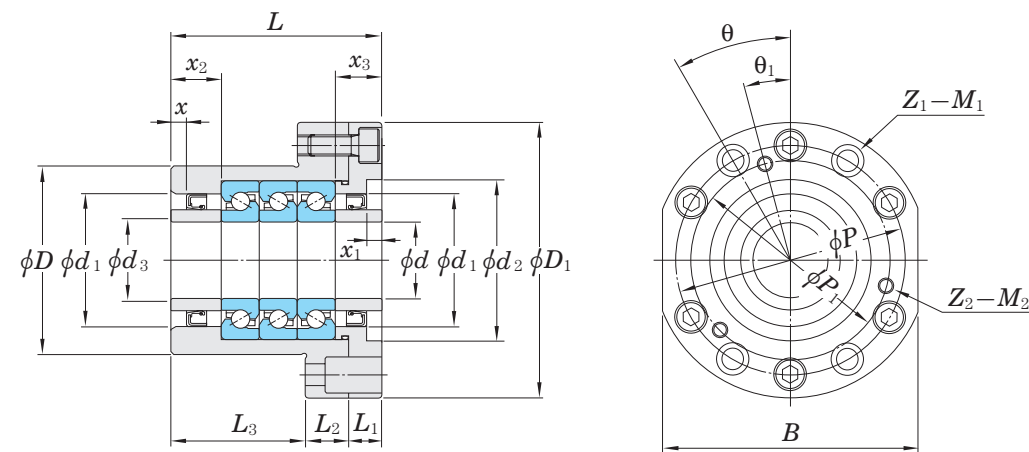

d	D	D ₁	B	L	Dimensions (mm)					Unit identification number	Quantity of bearing	Mounting hole of housing			Tapped hole for Dust-proof cover/Damper			Standard preload (kN)	Starting torque (mN·m)	(Refer.) Mass (kg)																														
					L ₁	L ₂	L ₃	d ₁	d ₂			d ₃	x	x ₁	x ₂	x ₃	P (mm)				θ (°)	Z ₁ -M ₁ (No. of holes-threads)	P ₁ (mm)	θ ₁ (°)	Z ₂ -M ₂ (No. of holes-threads)																									
17	60	90	80	65	15	15	35	38	47	28	6	6	15	20	BSU1747BDF - T	2	75	22.5	6 - M6	57	10	4 - M6	2.15	140	1.36																									
20	60	90	80	65	15	15	35	38	47	28	6	6	15	20	BSU2047BDF - T	2	75	22.5	6 - M6	57	10	4 - M6	2.15	140	1.32																									
25	74	108	100	68	13	17	38	52	63	32	6	6	20	18	BSU2562BDF - T	2	90	30	4 - M8	78	15	3 - M6	3.04	200	1.46																									
																										74	108	100	83	13	17	53	52	63	32	6	6	20	18	BSU2562BDFD - T	3	90	30	4 - M8	78	15	3 - M6	4.13	260	2.44
30	74	108	100	68	13	17	38	52	63	40	6	6	20	18	BSU3062BDF - T	2	90	30	4 - M8	78	15	3 - M6	3.04	200	1.40																									
																										74	108	100	83	13	17	53	52	63	40	6	6	20	18	BSU3062BDFD - T	3	90	30	4 - M8	78	15	3 - M6	4.13	260	2.47
35	84	118	105	68	13	17	38	60	73	45	6	6	20	18	BSU3572BDF - T	2	100	30	4 - M8	88	15	3 - M6	3.73	240	1.29																									
																										84	118	105	83	13	17	53	60	73	45	6	6	20	18	BSU3572BDFD - T	3	100	30	4 - M8	88	15	3 - M6	5.07	320	2.68
																										84	118	105	98	13	17	68	60	73	45	6	6	20	18	BSU3572BDFD - T	4	100	30	4 - M8	88	15	3 - M6	7.46	480	3.62
40	84	118	105	68	13	17	38	60	73	50	6	6	20	18	BSU4072BDF - T	2	100	30	4 - M8	88	15	3 - M6	3.73	240	1.24																									
																										84	118	105	83	13	17	53	60	73	50	6	6	20	18	BSU4072BDFD - T	3	100	30	4 - M8	88	15	3 - M6	5.07	320	2.72
																										84	118	105	98	13	17	68	60	73	50	6	6	20	18	BSU4072BDFD - T	4	100	30	4 - M8	88	15	3 - M6	7.46	480	3.64



II. Oil / Air Lubrication System

Contents	Page
1. Oil / air lubricator.....	184
2. Air cleaning unit.....	188

1. Oil / air lubricator

1.1 Oil / air lubrication

Oil / air is a new method of lubrication, which was developed to prevent atmospheric contamination caused by oil mist leakage, a phenomenon caused by the high speed of the spindles of machine tools combined with oil mist lubrication.

In oil / air lubrication, an extremely small quantity of oil is supplied and sprayed by air pressure directly into the bearings.

JTEKT has produced an oil / air lubricator and an air cleaning unit, for use as a lubrication system.

1) Features of oil / air lubrication

- ① Ensures a low level of temperature increase and power loss of bearing and enables a high rotation speed.
Supplies the necessary quantity of oil to each bearing in a reliable manner.
- ② High reliability.
Since new oil is constantly supplied to bearings, the user does not need to be concerned about the service life of the lubrication oil.
Furthermore, compressed air, which increases the internal pressure of the spindle, is effective in preventing dust or cutting fluid from entering from outside.
- ③ No atmospheric contamination.
A small quantity of oil flows on the surfaces of piping walls controlled by compressed air. This mechanism eliminates atmospheric contamination caused by oil mist leakage from oil mist lubrication.

2) System diagram of oil / air lubrication

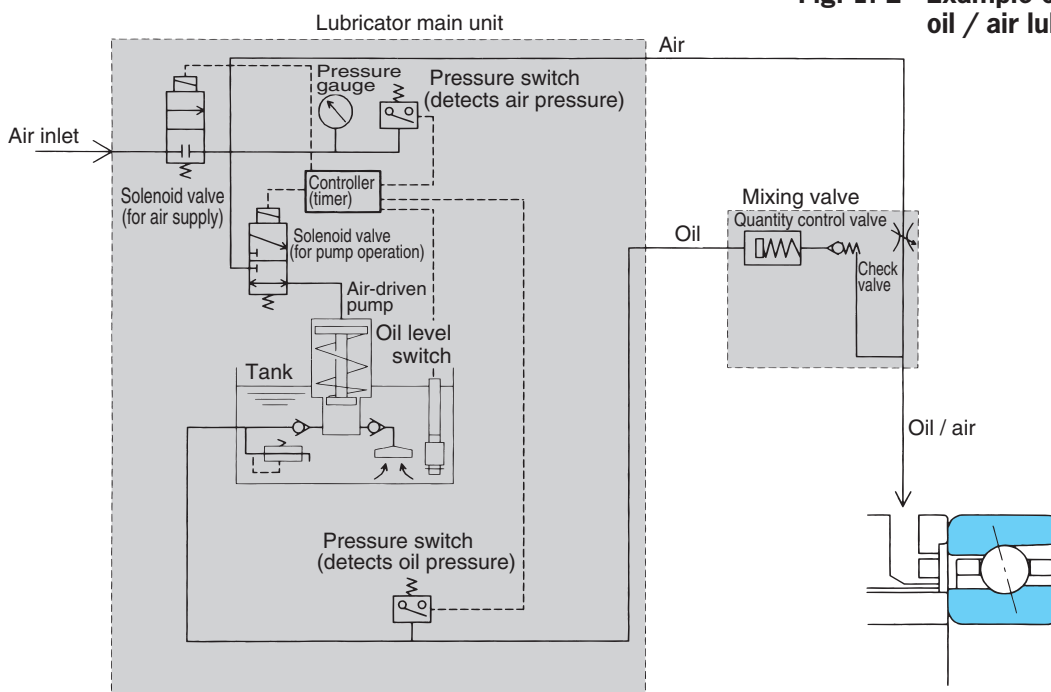

Fig. 1.1 System diagram of oil / air lubrication

3) Example of connections of oil / air lubrication system

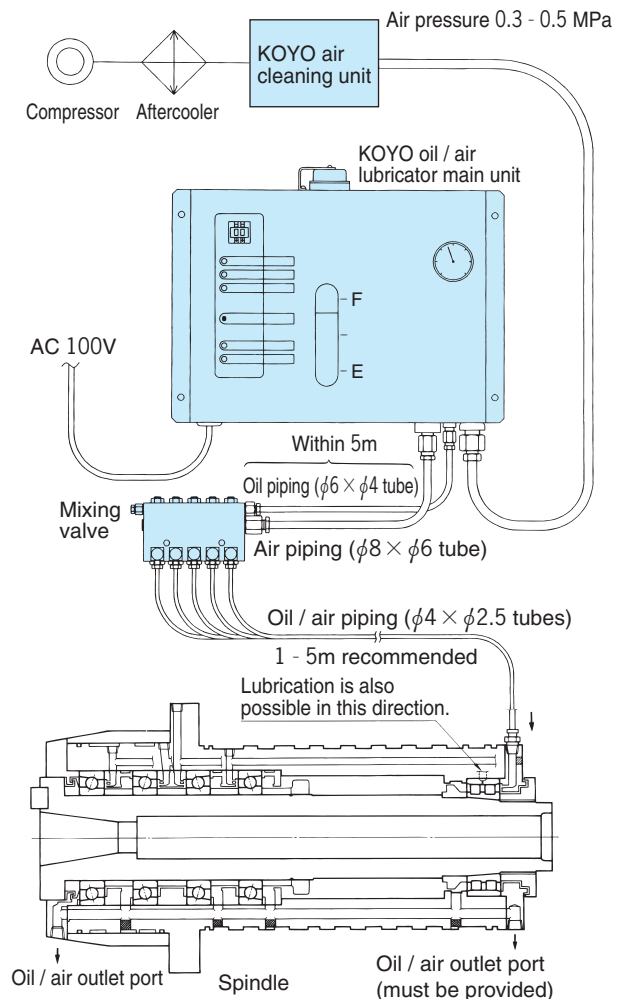
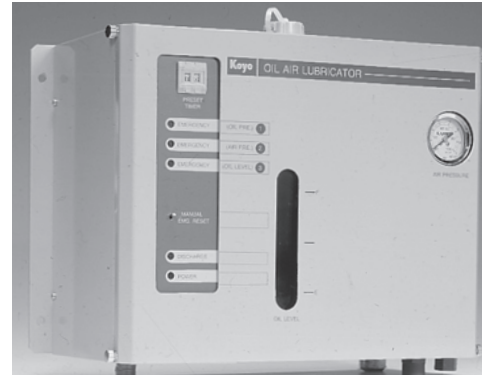

Fig. 1.2 Example of connections of oil / air lubrication systems

1.2 Oil / air lubricator

1) Features of KOYO oil / air lubricator

- ① Lubrication (discharge) intervals can be set to desired values.
The lubricator allows adjustment of lubrication (discharge) intervals from 1 to 99 minutes so that optimum settings for lubrication (discharge) intervals can be selected.
A lock mechanism is provided.
- ② A solenoid valve used to stop air flow is fitted.
It is included with the standard accessories.
The valve stops air flow when the machine main unit stops. This eliminates the need for valve operation when shutting down the machine when not in use.
- ③ Oil can be discharged continuously by manual operation.
Before starting oil / air lubricator, the air in the piping must be discharged (air bleed).
The lubricator has a circuit built in that allows a single or a successive 11 round oil discharge by manual operation.
- ④ A unique safety device is built in.
A level switch is attached to the oil tank, and pressure switches are attached to main oil and air pipes.
In the event of failure of the lubricator, the location of the failure is indicated by a lamp. In addition, an abnormality signal can be output from the abnormality signal contact points (EMG NO-EMGCOM and EMG NC-EMGCOM terminals on the side of the controller).



■ KOYO oil / air lubricator

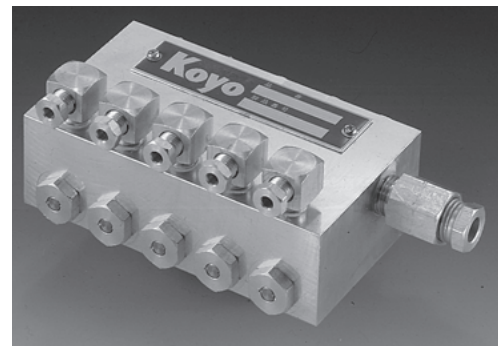

■ KOYO mixing valve

Discharges a small quantity of oil at a fixed rate into the compressed air flow for oil / air lubrication.

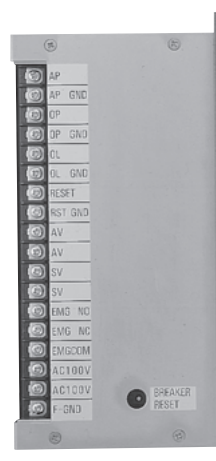

■ Controller side view

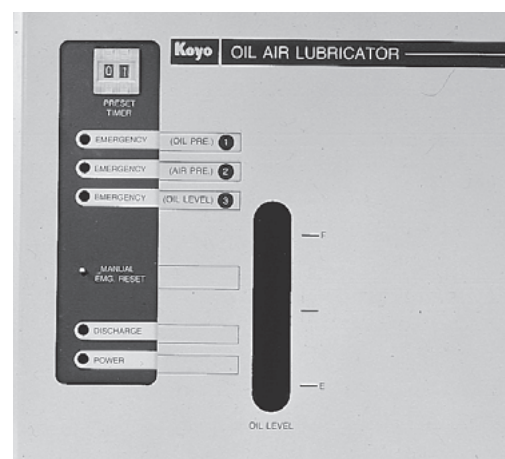

■ Controller front view

2) Model number of oil / air lubricator (including mixing valve)

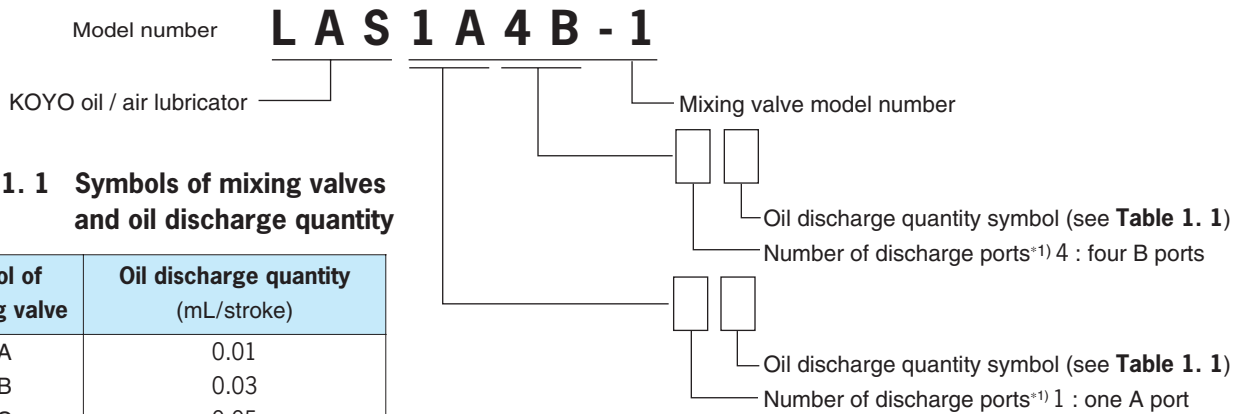

Table 1. 1 Symbols of mixing valves and oil discharge quantity

Symbol of mixing valve	Oil discharge quantity (mL/stroke)
A	0.01
B	0.03
C	0.05
D	0.10

For the discharge intervals of the oil / air, refer to Supplementary table 6 on page 219.

*1) The standard number of oil discharge ports is 5. As it is changeable, specify according to need. The number of maximum available ports is 8 per block.

3) Outline drawing and specifications of oil / air lubricator

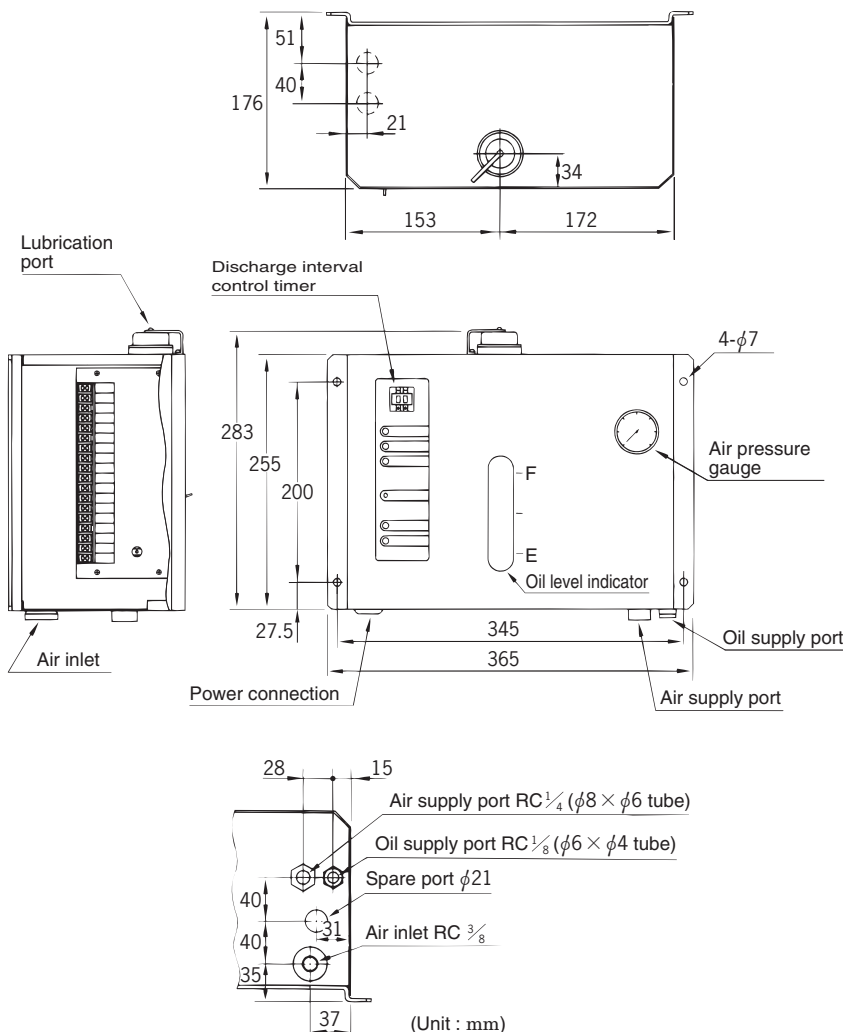

Table 1. 2 Specifications

Item	Specification
Supply voltage	AC100V, 50 / 60Hz
Power consumption	With pump in operation : approx. 20W Pump not in operation : approx. 12W
Service air pressure	0.3-0.5 MPa
Viscosity of oil used	10-100mm ² /s
Lubrication (discharge) intervals	Any desired value between 1 and 99 minutes in one-minute intervals
Tank capacity	1.8L (effective oil quantity : 1.4L)
Capacity of abnormality signal contact points	Contact point a : (EMG NO) 250V AC, 5A 30V DC, 5A Contact point b : (EMG NC) 250V AC, 2A 30V DC, 3A
Mass (refer.)	15 kg

[Note] AC200V is also available. Consult JTEKT.

Fig. 1. 3 Outline drawing and specifications of oil / air lubricator

4) Outline drawing and specifications of mixing valve

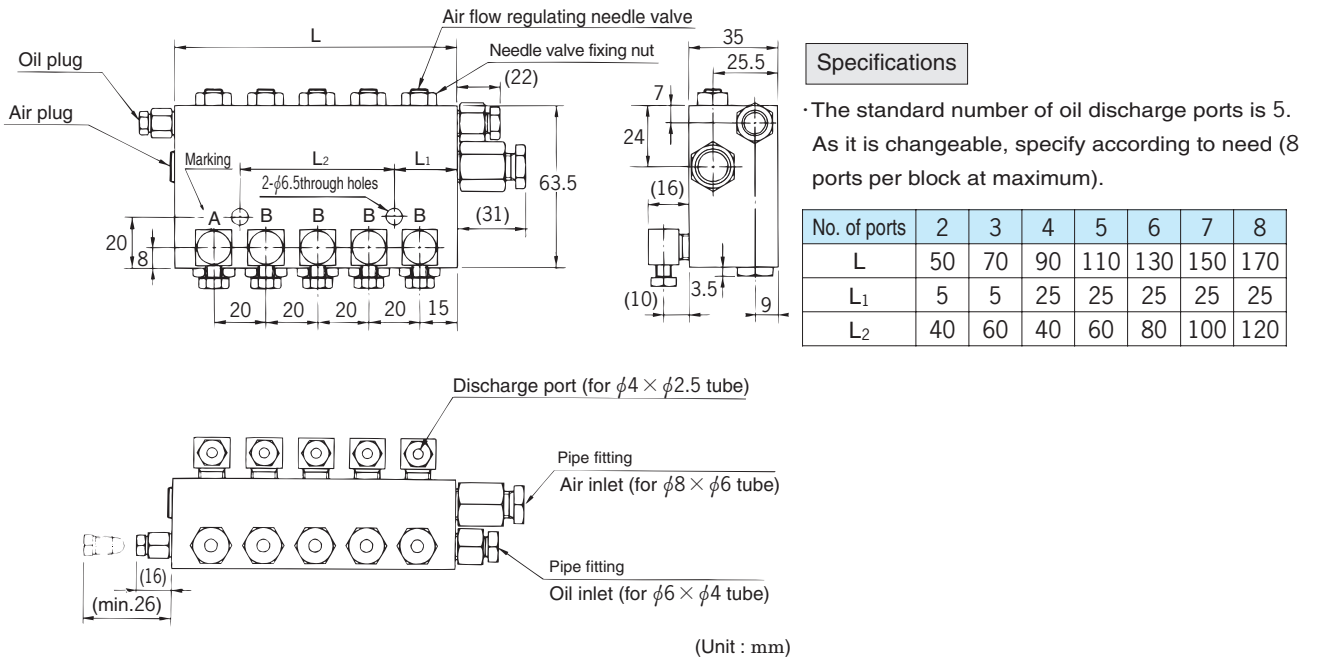

Fig. 1. 4 Outline drawing of KOYO mixing valve (example of 1A4B-1)

2. Air cleaning unit

Clean, dry air is required for oil / air lubrication, pneumatic bearings, etc.

JTEKT has developed and commercialized the air cleaning unit KAU05, a compact unit consisting of filters, an air dryer, mist separators, and other parts.

This unit efficiently and effectively removes moisture, oil, dust, etc. contained in compressed air.

1) Features of KOYO air cleaning units

- ① Removes moisture efficiently by refrigerated air dryer.
- ② Its micro-mist separator removes oil content 99.999 9% and solid foreign matter 0.01 μ m or greater in particle size.
- ③ Contains a differential pressure detection switch, which indicates clogging of filter.

In addition, an output signal is obtained from terminals attached on the differential pressure detection switch.



(Front)

(Rear)

■ KOYO air cleaning unit KAU05

2) Piping system diagram

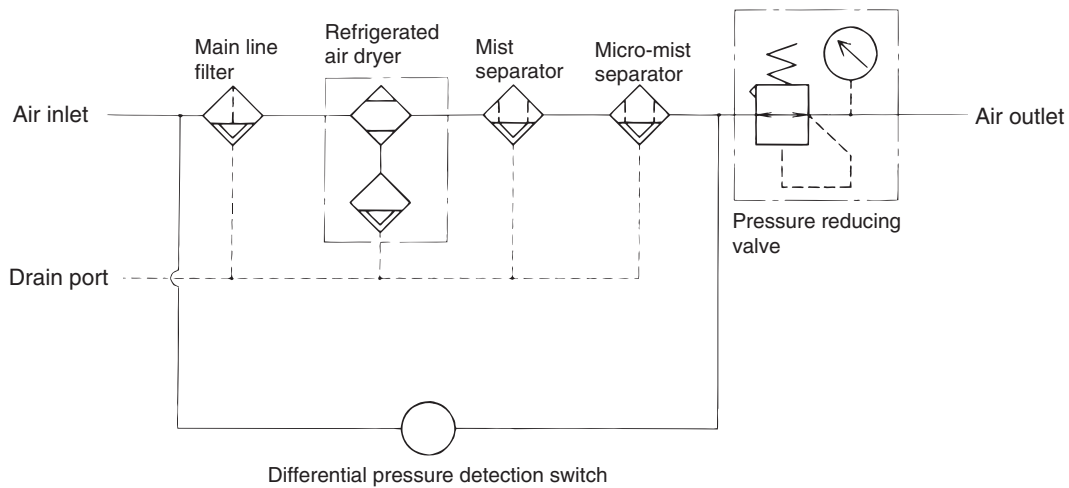

Fig. 2. 1 Piping system diagram of air cleaning unit

3) Outline drawing and specifications of air cleaning unit

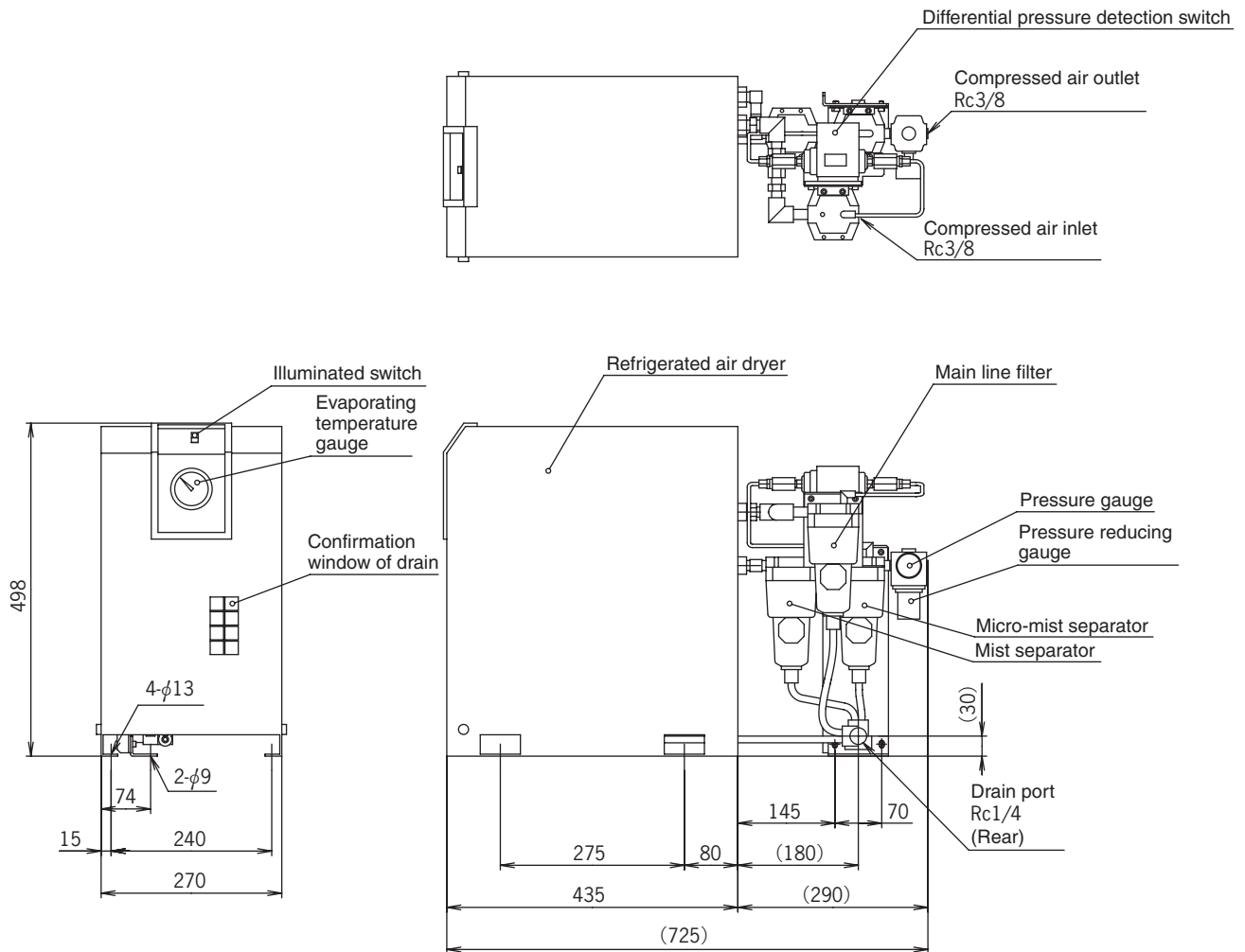

Fig. 2. 2 Outline drawing of KOYO air cleaning unit

Table 2. 1 Specifications of KOYO air cleaning unit KAU05

Item	Specification
Treatment air flow rate	0.52/0.57 m ³ /min
Inlet air pressure	0.7 MPa
Maximum temperature of inlet air	50 °C
Main line filter	3 to 50 μm (95%-arresting particle size)
Mist separator	0.3 μm (95%-arresting particle size)
Micro-mist separator	0.01 μm (95%-arresting particle size)
Oil content separation efficiency	99.999 9%
Solid substance separation efficiency	100% if 0.01 μm or greater
Supply voltage	Single-phase 100 V AC (50/60 Hz)*
Power consumption	180/202 W (50/60 Hz) (at 100 V)
Mass (refer.)	26 kg

*AC 200V is also available.



III. Handling of Bearings

Contents	Page
1. Handling and mounting of bearings	192

1. Handling and mounting of bearings

1.1 Handling precautions of bearings

1.1.1 Handling of bearings

Since ball & roller bearings are made to a higher precision than general mechanical parts, they should be handled carefully.

- ① Maintain bearings and their surroundings in a clean condition.
- ② Handle with care.
A severe shock to a bearing by rough handling may result in damage such as flaws, nicks and chipping.
- ③ Use correct handling tools.
- ④ Exercise care for rust prevention of bearings.
Avoid handling and storing them in a highly humid atmosphere.
- ⑤ Bearing should be handled by an experienced person.
- ⑥ Standard operating procedure for handling bearings should be established.
 - Storage of bearings
 - Cleaning of bearings and their peripheral parts
 - Inspection of dimensions and finish of peripheral parts of bearings
 - Mounting
 - Dismounting
 - Inspection after mounting
 - Maintenance and inspection
 - Replenishment of lubricant

1.1.2 Storage of bearings

Bearings are shipped after a high-quality anticorrosive oil is applied to them followed by a suitable wrapping and packing.

Their quality is guaranteed as long as the wrapping and packing are not damaged.

Bearing, if they are to be stored for a long time, should be stored on a shelf at least 30cm from the ground at 65% or less humidity at a temperature of around 20°C. Avoid direct exposure to sunlight. Keep bearings at a distance from walls.

1.2 Mounting of bearings

The mounting condition of the bearings affects the accuracy, performance and life of machines.

To optimize the performance of the bearings, it is necessary to strictly follow the procedure and instructions to mount them.

The procedure for mounting the bearings is shown in **Fig. 1. 1**.

In this section, a general procedure for mounting the bearings is described in accordance with the workflow shown in **Fig. 1. 1**.

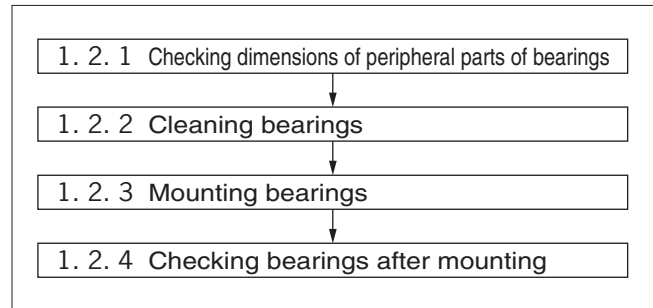

Fig. 1. 1 Mounting workflow

1.2.1 Checking dimensions of peripheral parts of bearings

Before mounting the bearing, clean the shaft, housing, spacer, etc. Ensure that the inside of the housing is absolutely free from any residual wrapping material (SiC, Al₂O₃, etc.), molding sand, or chips.

Next, inspect other parts. Check that the dimensions, shapes and roughness are as shown in the drawing, and there is no flaw, burr or barb. Measure the bearing diameter and the bore diameter of the housing at several positions as shown in **Figs. 1. 2** and **1. 3**, and confirm that the fitting is made correctly.

Record the measured values of these parts along with the inspection number of the bearing to be mounted.

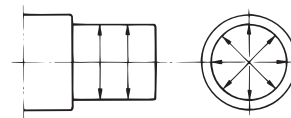

Fig. 1. 2 Measuring positions of shaft diameter

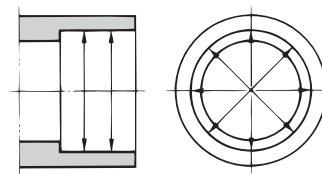

Fig. 1. 3 Measuring positions of housing bore diameter

Besides, pay attention to the fillet radii and the squareness of the shoulders of the shaft and housing. (See **Fig. 1. 4** on page 193.)

For the tolerances for the shaft diameters and the bore diameters of the housing, refer to **Figs. 6. 2** and **6. 3** of "**6. Rigidity and preload of bearings**".

Also, for the accuracy of the shaft and housing as well as the fillet radii, refer to "**9. Designing peripheral parts of bearings**".

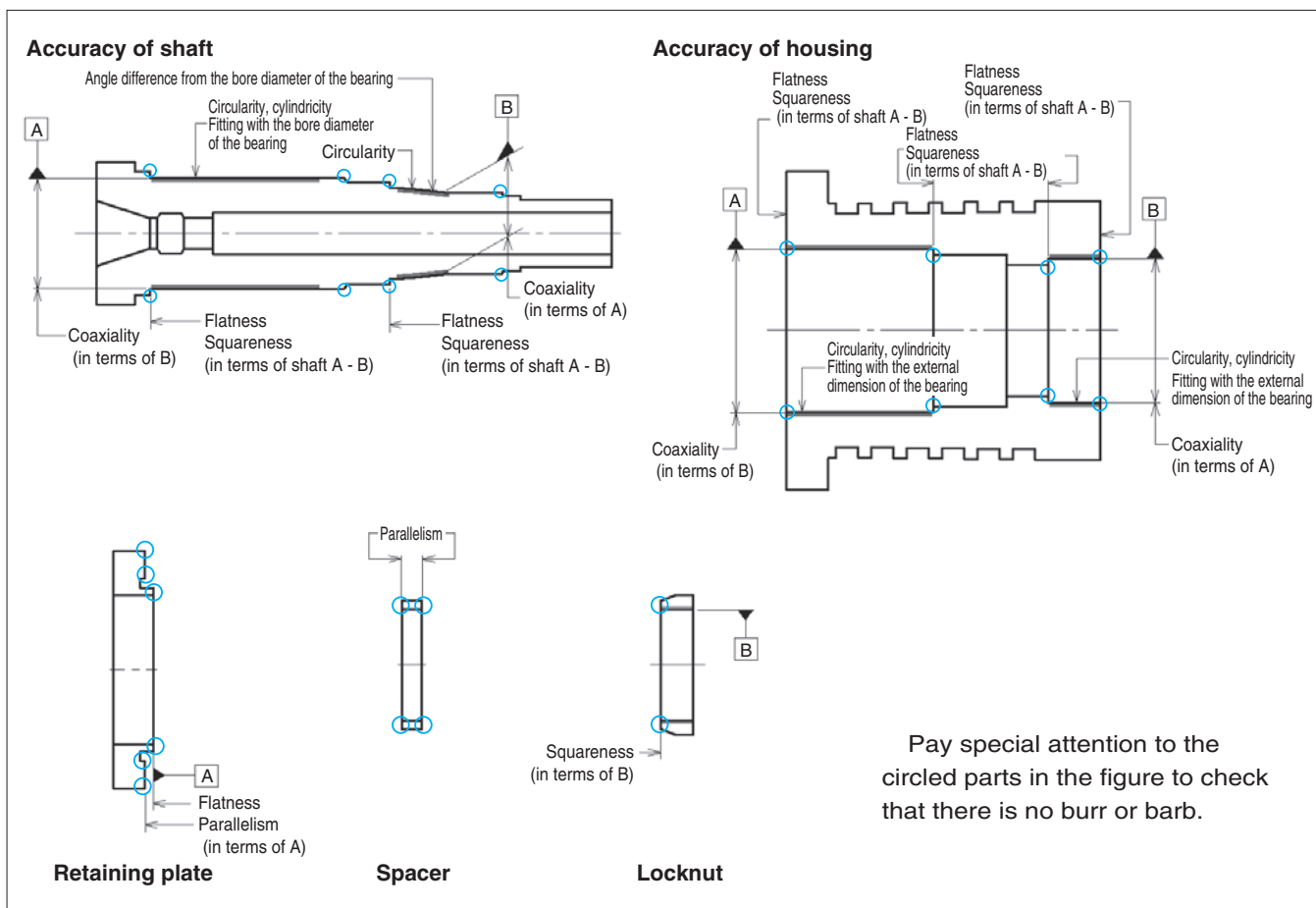

Fig. 1. 4 Points for checking the accuracy

1. 2. 2 Cleaning bearings

After preparing the parts necessary for mounting the bearings, unwrap the bearings just before starting to mount them.

Anticorrosive oil is applied to the bearings to prevent corrosion. After unwrapping the bearings, clean them

to remove the anticorrosive oil following the procedure shown in **Fig. 1. 5**.

After cleaning, degrease and dry the bearings. Then, seal grease (in case of grease lubrication) and mount the bearings.

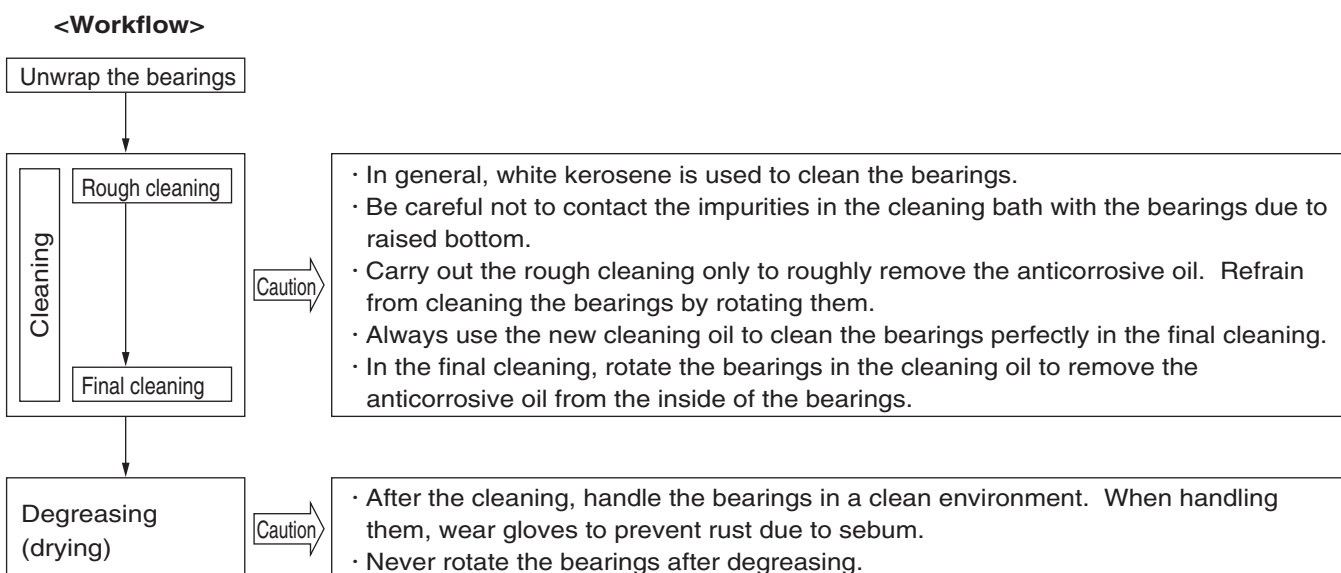

Fig. 1. 5 Cleaning workflow

1. 2. 3 Mounting bearings

The preparation before mounting the bearings varies depending on the bearing types and lubrication as shown in Fig. 1. 6.

For details, see Fig. 1. 6 to mount the bearings.

In case of the angular contact ball bearings, the fitting mark is indicated on the outside surface of the bearing (see page 54). Mount the bearing in the correct direction referring to the fitting mark.

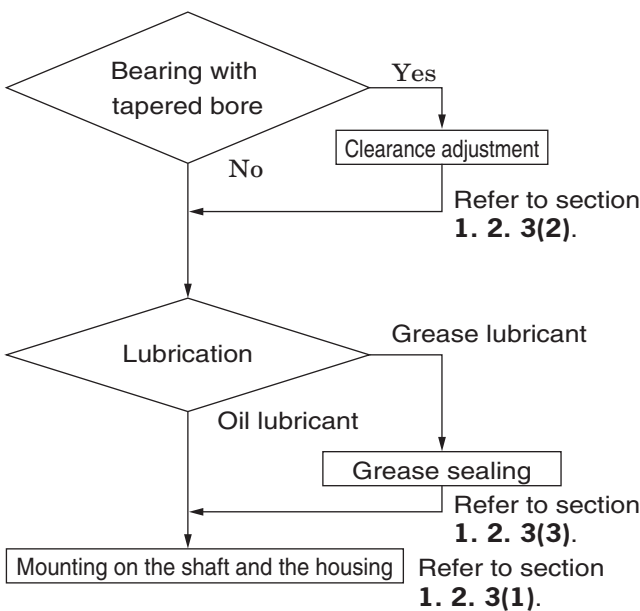

Fig. 1. 6 Preparation before mounting

1. 2. 3(1) Mounting on shaft and housing

① Bearing mounting

Mounting method of the bearings differs depending on types and fitting conditions.

In case of the bearings for machine tool spindles, the inner ring is usually rotated. Therefore, the interference fit is applied for the inner rings, and the clearance fit is applied for the outer rings.

As a method of interference fit, the shrinkage fit is usually applied for the cylindrical bore bearings. In case of the bearings with tapered bore, the inner ring is press fitted in the taper shaft. In this case, the bearing internal clearance needs to be adjusted as described in section 1.2.3(2) beforehand, because it is necessary to control the radial internal clearance after fitting.

The clearance fit is used to fit the outer ring in the housing. To facilitate the mounting, the housing is heated to expand the bore diameter before mounting the bearing.

The bearing before mounting, which is used for oil

lubrication, is very susceptible to flaws, because it is cleaned and degreased and is in metallic contact with a rolling element and raceway. To protect the raceway during the mounting, it is recommended to apply a small quantity of oil used for the machine to be mounted inside the bearing.

● Shrinkage fit

Heat the bearing assembly or inner ring on an induction heater or hot plate to induce expansion before mounting it onto a shaft.

If this method is used, no force is applied to the bearing and operation is carried out in a short time.

When a hot plate is used to heat up a bearing assembly, the use of a jig as shown in Fig. 1. 7 enables efficient heating of the inner ring.

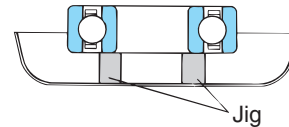

Fig. 1. 7 Inner ring heating jig

Specify the heating temperature of the bearing in accordance with the size and the required expansion, referring to Fig. 1. 8. Specify the temperature about 20 to 30°C higher than the required temperature, taking into consideration the temperature to be reduced during the operation.

However, never heat the bearing up to 120°C or more.

After mounting the bearing, shrinkage will occur in the width as the bearing cools off. Therefore, fit the inner ring and the shoulder firmly using a locknut to prevent clearance between them.

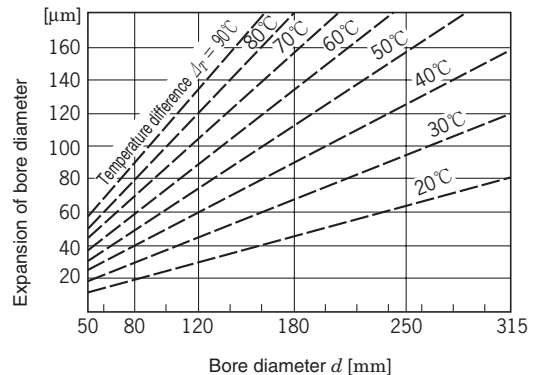

Fig. 1. 8 Heating temperature and expansion of inner rings

● Press fit

Be sure to use the specific jig to mount the inner ring to the shaft and the outer ring to the housing. When press fitting the inner ring and the outer ring, hold only the inner ring and the outer ring, respectively, and apply gently uniform pressure to the whole circumference surface.

Never mount the rings using hammer.

To facilitate the mounting, it is recommended to apply a small quantity of lubricant to the shaft or housing before press fitting.

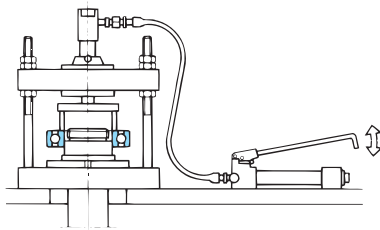

Fig. 1. 9 Press fitting by pressing machine

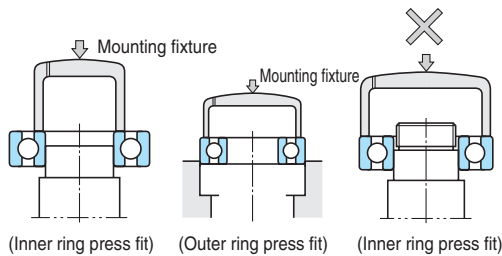

Fig. 1. 10 Example of press fitting jig

[Reference] Force is necessary to press fit or remove bearings

The force necessary to press fit or remove inner rings of bearings differs depending on the finish of shafts and how much interference the bearings allow. The standard values can be obtained by using the following equations.

(In the case of solid shafts)

$$K_a = 9.8 f_k \cdot \Delta_{d_{eff}} \cdot B \left(1 - \frac{d^2}{D_i^2} \right) \times 10^3 \dots\dots\dots(1. 1)$$

(In the case of hollow shafts)

$$K_a = 9.8 f_k \cdot \Delta_{d_{eff}} \cdot B \frac{\left(1 - \frac{d^2}{D_i^2} \right) \left(1 - \frac{d_0^2}{d^2} \right)}{\left(1 - \frac{d_0^2}{D_i^2} \right)} \times 10^3 \dots\dots\dots(1. 2)$$

Where:

K_a : force necessary for press fit or removal N

$\Delta_{d_{eff}}$: effective interference mm

f_k : resistance coefficient

[Coefficient taking into consideration friction between shafts and inner rings ... refer to the table below.]

B : nominal inner ring width mm

d : nominal inner ring bore diameter mm

D_i : average outside diameter of inner ring mm

d_0 : hollow shaft bore diameter mm

Value of resistance coefficient f_k

Conditions	f_k
· Press fitting bearings on to cylindrical shafts	4
· Removing bearings from cylindrical shafts	6
· Press fitting bearings on to tapered shafts or tapered sleeves	5.5
· Removing bearings from tapered shafts or tapered sleeves	4.5
· Press fitting tapered sleeves between shafts and bearings	10
· Removing tapered sleeves from the space between shafts and bearings	11

② Tightening of bearings

●Tightening of inner ring

As a way of fixing the inner ring to a shaft, a locknut is usually used. **Fig. 1. 11** shows an example of fixing an inner ring using a locknut.

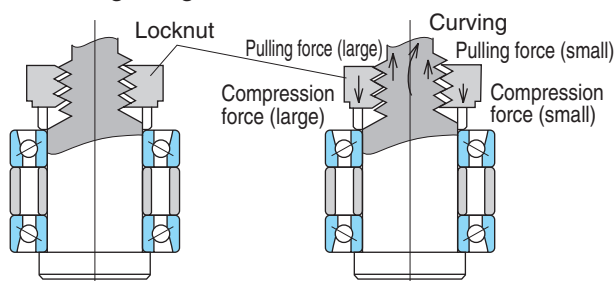

Fig. 1. 11 Example of fixing on inner ring using a locknut

As a clearance is present between thread of the locknut and that of the shaft, fixing the inner ring by using a locknut results in the center of the locknut deviating from the center of the shaft. This deviation in turn causes inclination of the inner ring or bending of the shaft.

As a result, the running accuracy of the shaft is decreased or an abnormal temperature increase is experienced due to the high load applied to the bearing (see **Fig. 1. 12**).

To settle this problem, positioning (centering) of the locknut is necessary after tightening.

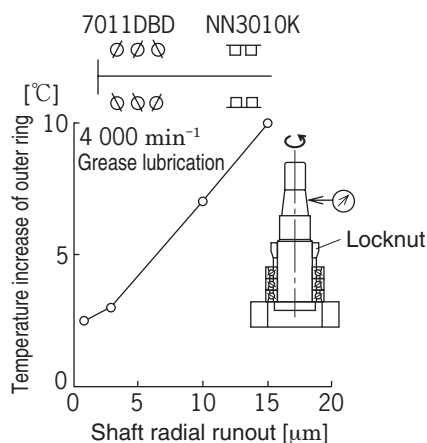

Fig. 1. 12 relationship between shaft radial runout and temperature increase of the outer ring caused by the faulty positioning of the inner ring

Furthermore, the axial force generated by tightening the locknut leads to compressive strain of the inner ring and inner ring spacer, which in the case of position preloading, influence the amount of preload applied to the bearing.

For those applications which are considerably affected by preload, such as a high-speed spindle, this compressive strain should be taken into consideration. Consideration to other types of bearing supports are the inclination of inner rings, bending of shafts, and axial forces. In cases where a interference fit sleeve is used to fix a bearing, the tolerance of the sleeve is of

vital importance since positioning becomes difficult once the bearing is fitted.

Tightening forces (shaft forces) of the locknuts or sleeves used to fix the inner rings are indicated as standard values in the bearing dimension table.

Note that if the interference of inner ring is large and the number of bearing rows is large, the press fitting force also becomes large.

●Tightening of outer rings

Outer rings are fixed to the housing usually by means of a retaining plate.

The retaining plate is fastened to the housing with several bolts. Inadvertent fastening of the retaining plate, however, may result in an inclination and / or deformation of the outer ring.

If inclination and / or deformation occurs in the outer ring, the rolling elements and the cage cannot rotate properly, possibly causing unusual noise generation.

In order to prevent this, it is necessary to tighten the retaining plate fastening bolts with an even torque in diagonal sequence. The fastening bolts should not be fastened individually to the final torque, but in a step-by-step sequence (see **Fig. 1. 13**).

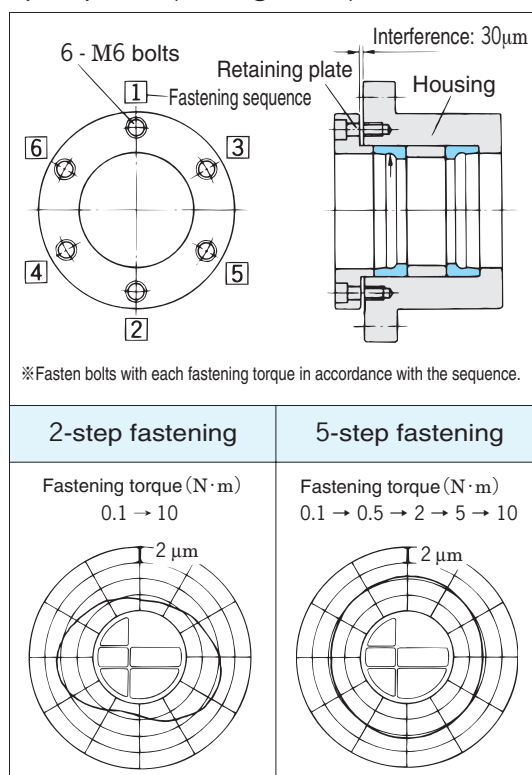

Fig. 1. 13 Raceway roundness variations with respect to the various fastening method

A slight interference is provided between the housing and retaining plate to hold the outer ring firmly.

If variations on the interference exist on the circumference due to poor tolerance of the retaining plate or housing, fastening the retaining plate may cause inclination of the outer ring.

Therefore, sufficient care should be taken to ensure tolerance of the retaining plate and housing.

For the interference between the housing and retaining plate, refer to the dimension table for each bearing.

1. 2. 3(2) Adjusting of clearance

In case of the cylindrical roller bearing with tapered bore, it is necessary to adjust the dimension of the spacer to adjust the radial clearance of the bearing.

The adjustment is made as follows.

- (1) Lightly apply low-viscosity oil (kerosene, etc.) to the taper part of the shaft and fit slightly the inner ring of the cylindrical roller bearing into the shaft (Fig. 1. 14).

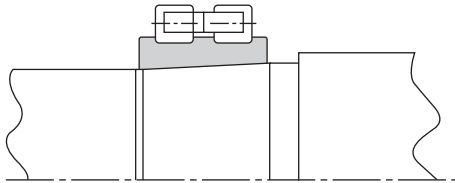

Fig. 1. 14 Temporary mounting of inner ring

- (2) Using a block gauge, measure the distance between the end face of the inner ring and that of the shoulder (Fig. 1. 15).

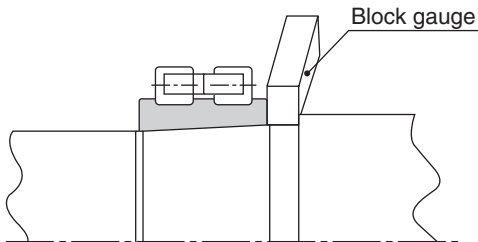

Fig. 1. 15 Width of spacer

- (3) Temporarily adjust the width of the spacer. Adjust the width of the spacer to the distance between the end face of the inner ring and that of the shoulder as measured in step (2). It is recommendable to make the outside diameter of the spacer larger than the diameter of the shaft shoulder to facilitate the pulling-out (Useful when pulling out the inner ring).

Note: The parallelism of lateral side of the spacer must be 0.001mm or less.

- (4) After degreasing the outside surface and the bore, fit the temporarily adjusted spacer and mount the inner ring onto the shaft. Be careful not to make clearance between the end face of the spacer and that of the inner ring and clearance between the end face of the spacer and that of the shaft shoulder (Fig. 1. 16).

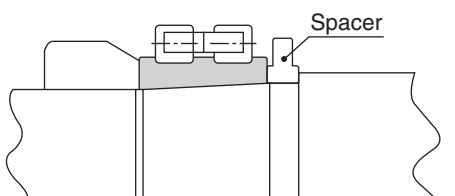

Fig. 1. 16 Mounting of spacer

- (5) Place the dial gauge on the outside surface of the outer ring, and move the outer ring upward and downward on the axial line of the dial gauge needle to measure the residual radial internal clearance (Fig. 1. 17).

- (6) After measurement, pull the bearing and the spacer out of the shaft.

Never hit the bearing to pull it out (Hit gently the end face of the spacer of large outside diameter).

- (7) Based on the radial internal clearance measured in step (5), use the equation shown below to calculate the adjustment value of the inner ring to obtain the desired residual radial internal clearance.

In case of taper 1/12,

$$\text{Adjustment value } \Delta_A = (R_{sa} - R_{sb} - R_{sc}) \times 12 / K$$

Where:

R_{sa} : measured radial internal clearance the value measured in step (5)

R_{sb} : desired radial internal clearance

R_{sc} : contraction of the outer ring raceway due to fitting (0 in case of clearance fit)

K : expansion coefficient of the inner ring raceway due to press fitting

Formula to calculate R_{sc}

$$R_{sc} = \Delta_{Deff} \frac{D_e}{D} \cdot \frac{\left(1 - \frac{D^2}{D_h^2}\right)}{\left(1 - \frac{D_e^2}{D_h^2}\right)}$$

Formula to calculate K

$$K = \frac{d}{D_i} \frac{\left(1 - \frac{d_0^2}{d^2}\right)}{\left(1 - \frac{d_0^2}{D_i^2}\right)}$$

Where:

Δ_{Deff} : effective interference of outer ring

D_h : outside diameter of housing

D_e : outer ring raceway contact diameter

[ball bearing $D_e \cong 0.2 (4D + d)$
roller bearing $D_e \cong 0.25 (3D + d)$

D : nominal outer ring outside diameter

d : nominal inner ring bore diameter (shaft diameter)

d_0 : bore diameter of hollow shaft

D_i : inner ring raceway contact diameter

[ball bearing $D_i \cong 0.2 (D + 4d)$
roller bearing $D_i \cong 0.25 (D + 3d)$

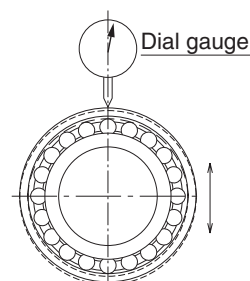

Fig. 1. 17 Measurement of residual radial clearance

(8) Adjust the width of the spacer.

The width of the spacer must be the value temporarily adjusted minus the adjustment value calculated in step (7).

Note: The parallelism of lateral side of the spacer must be 0.001 mm or less.

(9) After cleaning, mount the bearing and the spacer onto the shaft.

Push inner ring sufficiently so that the end face of the spacer and that of the inner ring as well as the end face of the spacer and that of the shaft shoulder contact each other completely (**Fig. 1. 18**).

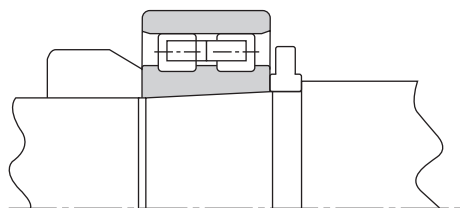

Fig. 1. 18 Mounting of bearing

(10) As in step (5), check the residual radial internal clearance of the bearing.

If the desired value of the radial internal clearance is not obtained, return to step (7) and make adjustment again.

(11) After checking that the desired value of the radial internal clearance is obtained in step (10), pull the bearing and spacer out of the shaft temporarily to clean and degrease them. In case of grease lubrication, seal them with the specified amount of grease, and then reassemble them.

1. 2. 3(3) Grease sealing

If the sealed amount of grease or the sealing method is not appropriate, overheating or instability (**Fig. 1. 19**) may result during breaking-in, and an extended time of breaking-in may become necessary.

Therefore, be sure to seal the bearing with an appropriate amount of grease in correct manner.

Sealing method of grease is described below.

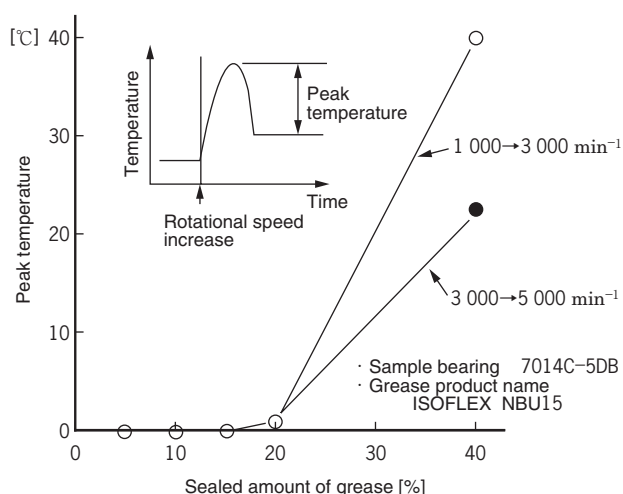

Fig. 1. 19 Relationship between sealed amount of grease and peak temperature

① Preparation before sealing

- Clean and degrease the bearing. And check that there is no stain of anticorrosive oil or impurity on the interspace and outer surfaces of the bearing.
- An appropriate amount of grease must be applied uniformly to the specified locations in the bearing. To apply grease, it is recommended to use a specific tool with measuring gauge, which has a nozzle tip.
- The tool used to apply grease also has to be cleaned off and degreased.
- Before applying grease, check the amount of grease to be sealed. The amount should be 10 to 15% of the space capacity of the bearing. (The space capacity of each bearing and the sealed amount of grease are shown in the bearing dimension table.)

② Method for grease sealing

Grease must be applied uniformly to the bearing raceway surface and the retainer guide as shown in **Fig. 1. 20**.

After applying grease, manually rotate the bearing to let the grease spread all over the inside of the bearing.

Also, after application of grease, be careful not to let impurities dust to the bearing.

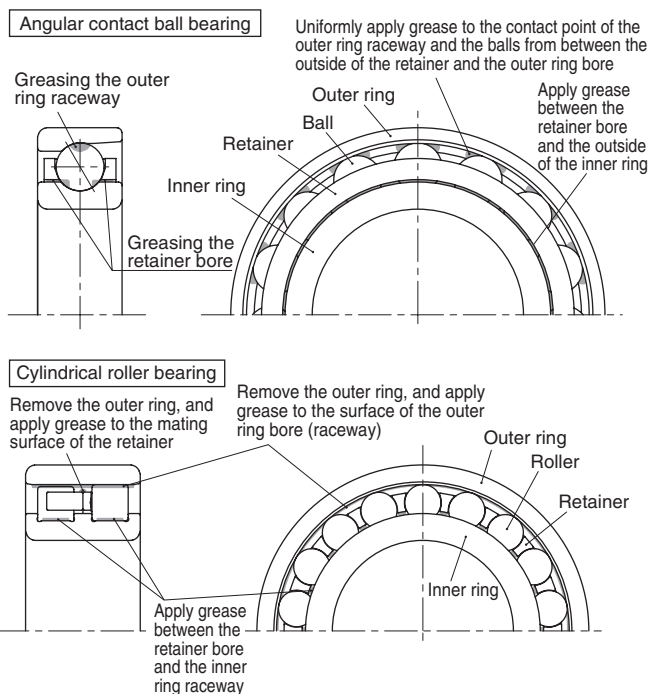

Fig. 1. 20 Grease sealing points

1. 2. 4 Check after mounting bearings

1. 2. 4(1) Checking of preload

Preload of the bearing affects its rigidity and heat generation. If the preload is inadequate, not only the standard performance is not obtained, but also the life span is shortened and seizure results.

Therefore, it is important to check that the specified preload is applied to the bearing after completing the mounting of the bearing.

In this section, the following methods for checking the preload, which are generally used, are described.

① Check using the starting torque

If the preload of the bearing becomes large, the starting torque also tends to increase. Therefore, the preload can be checked by measuring the starting torque value.

Wind the thread on the shaft or the outer ring and fix it. By pulling the thread tangentially, measure the tension of the thread when the bearing starts to rotate using a tension gauge, etc. After obtaining the starting torque, the preload can be presumed referring to the correlation between the starting torque and the preload.

The starting torque can be measured easily. However, in case of the bearings used with low preload (e.g. angular contact ball bearing used as a spindle), the measurement error can be large because the starting torque is small. This method is recommendable when using the ball screw support bearings by applying heavy preload to them.

Note that it is necessary to standardize the sampling and measurement conditions because the condition of the lubricant and pulling speed affect the measurement result.

② Check using the axial rigidity

The preload is confirmed referring to the correlation between the shaft end axial deviation measured by applying the axial load to the shaft end, and the axial rigidity and the preload.

This method is not recommendable when using a main shaft of high rigidity because the deviation is very small.

To use this method, a large-sized facility such as a load applying device is necessary. Also, it is necessary to standardize the sampling and measurement conditions because the parts other than the bearing have elastic deformability.

③ Check using the proper vibrations

The preload is confirmed referring to the correlation between the spring constant of the bearing and the preload.

This method guarantees accuracy and repeatability of measured values.

However, the fixing method has to be meticulously inspected and standardized because the results are affected by the fixing method.

1. 2. 4(2) Breaking-in

In case of the bearings for grease lubrication, after installation of a bearing, problems are likely to occur due to rapid temperature rise caused by the immediate application of the maximum specified rotational speed. Therefore, breaking-in of the bearing is recommended, in which rotational speed is increased gradually.

Specifically, roller bearings require adequate breaking-in.

Fig. 1. 21 shows an example of breaking-in.

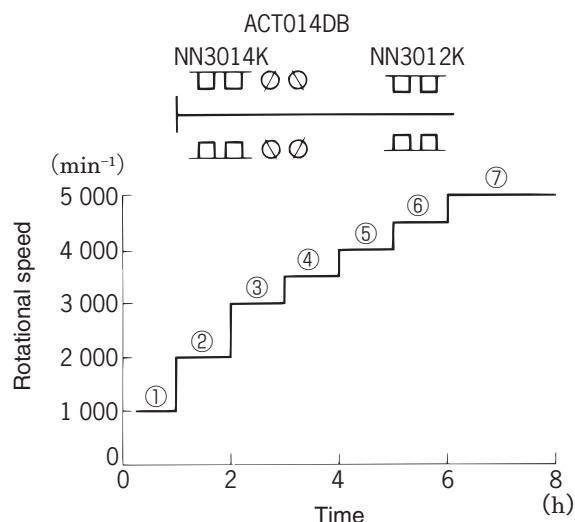

Fig. 1. 21 Example of breaking-in
(In case of 5 000 min⁻¹ max. speed)

If carrying out the break-in, after increasing the rotational speed, wait until the temperature of the bearing stops to increase or starts to decrease. Then, increase the rotational speed further.

Never increase the rotational speed when the temperature of the bearing is increasing.

The higher the temperature of the bearing becomes, the faster the grease deteriorates. Therefore, it is important to monitor the temperature during the breaking-in. When the temperature reaches a certain level, stop the operation temporarily. After the bearing cools off, resume the break-in starting from the rotational speed at which the operation was stopped or lower.

If the temperature is measured on the outside surface of the housing or retaining plate, the temperature at which the operation should be stopped is the room temperature plus 30 to 40°C (Supposing that the room temperature is 15 to 25°C).

The break-in is not required for the bearings lubricated with oil. However, if the bearings are used for the first time or after stored for an extended period of time, it is recommended to carry out the break-in because an abrupt increase of temperature may be expected due to the oil remaining in the lubrication duct and the inside of the bearing (excessive oil quantity).

1. 2. 4(3) Trial run and inspection

A trial run and inspection are carried out when bearings have been mounted, in order to check whether the mounting is adequate.

In the case of a small spindle, the rotation condition is examined initially by rotating it manually. After confirming that the below conditions do not exist, a further inspection is carried out by a powered run.

- Unsmoothness.....Possible causes are mixing of foreign matter, flaw in rolling surfaces, etc.
Grease used in grease lubrication may cause a phenomenon of unsmoothness at the initial stage.
In such cases, unsmoothness disappears after breaking-in.
- Excessive torque.....Possible causes are friction in the sealing device, insufficient clearance, etc.
- Uneven rotational.....Possible causes are defective mounting, and / or errors in mounting dimensions.

In the case of a large spindle that cannot be rotated manually, start it under unloaded condition and immediately after starting, turn the power off and allow to coast.

After verifying that the shaft is free of abnormal vibration or noise and rotates smoothly, proceed to powered run.

Powered run should be started with no load applied and at a low speed, before being increased gradually to a given condition.

Noise, temperature increase, and vibration are principal judging factors in powered run and inspection. If a faulty condition such as shown in **Tables 1. 1** and **1. 2** (page 200 and 201) occurs, conduct a further inspection immediately.

In some cases, it is necessary to remove the bearing for inspection.

Table 1. 1 Bearing noises, causes, and countermeasures

Noise types		Causes	Countermeasures
Cyclic	Flaw noise (similar to noise when punching a rivet ¹⁾) Brinelling noise (unclear siren-line noise ¹⁾)	Flaw on raceway Brinelling on raceway	Improve mounting procedure, cleaning method and rust preventive method. Replace bearing.
	Flaking noise (similar to a large hammering noise ¹⁾)	Flaking on raceway	
Not cyclic	Dirt noise (an irregular sandy noise ¹⁾)	Insertion of foreign matter	Improve cleaning method, sealing device. Use clean lubricant. Replace bearing.
	Flaw noise, flaking noise	Flaws and flaking on rolling elements	Replace bearing.
	Squeak noise (often heard in cylindrical roller bearing with grease lubrication, especially in winter or at low temperature)	If noise is caused by improper lubrication, a proper lubricant should be selected. In general, however, serious damage will not be caused by an improper lubricant if used continuously.	
Others	Abnormally large metallic sound	Abnormal load Incorrect mounting Insufficient amount of or improper lubricant	Review fitting, clearance. Adjust preload. Improve accuracy in processing and mounting shafts and housings. Improve sealing device. Refill lubricant. Select proper lubricant.

[Note] 1) In case of slow or medium rotation.

Table 1. 2 Causes and countermeasures for abnormal temperature rise

Causes	Countermeasures
Too much lubricant	Reduce lubricant amount
Insufficient lubricant	Refill lubricant
Improper lubricant	Select proper lubricant
Abnormal load	Review fitting and clearance conditions and adjust preload
Improper mounting (excessive friction)	Improve accuracy in processing and mounting shaft and housing. Review fitting. Improve sealing device.

Normally, listening rods are employed for bearing noise inspections. The device, which detects abnormalities through sound vibration, and the system, which utilizes acoustic emission for abnormality detection, are useful for more precise inspection.

In general, bearing temperature can be estimated from housing temperature, but the most accurate method is to measure the temperature of outer rings directly via lubrication holes.

Normally, bearing temperature begins to rise gradually when operation is just starting; and, unless the bearing has some abnormality, the temperature stabilizes within one or two hours.

Therefore, a rapid rise in temperature or unusually high temperature indicates some abnormality.

1. 2. 5 Dismounting of bearings

Dismounting a bearing for reuse or identification of causes of failure should be carried out in a careful manner similar to that of when mounted. Care should be taken to avoid damage to the bearing and other parts.

Specifically, when dismounting a bearing involving an interference, the dismounting process of the bearing should be taken into consideration at the designing stage of the shaft and housing.

It is recommended to make a jig for dismounting where appropriate.



IV . Examples of Bearing Failures

Contents	Page
1. Bearing failures, causes and countermeasures	204

1. Bearing failures, causes and countermeasures

It is necessary to carry out the maintenance and inspection to use the machine equipment always in stable conditions.

The bearing is an important part of the machine installation. If the bearing is damaged, the machine may become nonoperating and other inadvertent effects may occur.

Rotation noise, vibrations, temperature and torque are important phenomena to determine the status of the bearing. If any abnormality is perceived in such phenomena, it is necessary to immediately find the cause of the problem and take appropriate measures.

In **Table 1. 1**, bearing failures, possible causes and countermeasures are shown.

Table 1. 1 Bearing failures, causes and countermeasures

Phenomena	Causes	Countermeasures	Notes	
Temperature rise	Excessive	Excessively small quantity of lubricant	Check the quantity of the enclosed grease and the oil / air blow. Check that there is no leakage in the oil / air pipe.	Usually this phenomenon is accompanied by metallic noise. Grease may be deteriorated or leaking if this phenomenon occurs during normal operation in case of grease lubrication.
		Excessively large quantity of lubricant	Check the quantity of the enclosed grease and the oil / air blow.	In case of grease lubrication, the breaking-in may be insufficient.
		Angular contact ball bearing: excessive preload Cylindrical roller bearing: excessive negative clearance	Check the bearing axial clearance and mounting conditions.	Refer to case ① (page 205).
		Inadequate mounting precision	Check that there is no misalignment.	If reinstalling the bearing, it is necessary to check the precision of the parts after dismounting it.
		Insufficient cooling	Check the availability of the cooling capacity required.	
		External factors	Check that the belt tension is not excessive, the built-in motor is not heated excessively, and the coupling core is precisely placed.	
		Deterioration of bearing	Replace the bearing.	Usually this phenomenon is accompanied by torque rise.
	Instable	Oil / air lubrication: bad exhaust Grease lubrication: insufficient breaking-in	Check the oil / air exhaust route.	In case of oil / air lubrication, if the oil blows intermittently (irregularly) from the exhaust port, the exhaust (oil drainage) is not carried out correctly.
Noise	Metallic noise	Excessively small quantity of lubricant	Check the quantity of the enclosed grease and the oil / air blow. Check that there is no leakage in the oil / air pipe.	This phenomenon is accompanied by excessive temperature rise. Grease may be deteriorated or leaking if this phenomenon occurs during normal operation in case of grease lubrication.
	Continuous noise	Contact and interference between all rotating parts and all non-rotating parts	Check the conditions of the mounted parts, including the labyrinth.	If this phenomenon occurs during normal operation, it may be the secondary phenomenon of a temporal failure.
		Unbalanced shaft and imprecise rotation	Adjust the shaft balance. Readjust the rotational accuracy.	This phenomenon is accompanied by buzzing noise. If this phenomenon occurs during normal operation, it may be the secondary phenomenon of a temporal failure.
		Rough surface and brinelling of raceway	Replace the bearing in the case of entry of foreign particle, flaking and excessive load.	Refer to cases ② and ③ (page 205 and 206). If there is no measure taken, this phenomenon may occur repeatedly.
	Intermittent noise	Noise of cages, and slippage because of preload leakage	If the preload is excessively small, check the axial clearance and mounting conditions of the bearing.	
Vibrations		Unbalanced shaft	Adjust the shaft balance. Readjust the rotational accuracy.	
		Excessive radial clearance of cylindrical roller bearing	Check the radial clearance of the bearing. Check the mounting conditions.	In case of the bearing with tapered bore, the shaft nut may be loose. Also, the wear may have worsened.
		Rough surface and brinelling of raceway	Replace the bearing in the case of entry of foreign particle, flaking and excessive load.	Refer to cases ② and ③ (page 205 and 206).

Case ① Excessive bearing preload

Causes

1) Inadequate fitting

- Excessively large interference fitting of the inner ring
⇒ Due to the increase of interference of the inner ring and the shaft, the diameter of the raceway expands and the preload increases.
- Excessively small clearance fitting of the outer ring
⇒ If a temperature difference is generated between the outer ring and the housing, the outer ring is compressed and the diameter of the raceway shrinks, resulting in an increase in preload.

2) Inadequate tightening force of the bearing

- If the tightening force of the inner ring (nut shaft force etc.) is excessively large, the inner ring is deformed in axial direction and the preload increases.

3) Excessive cooling of the housing

- If the outer surface of the housing is excessively cooled, the phenomenon described in item 1) is generated and the preload increases.

4) Failure in constant-pressure preloading and variable preloading system

- If the outer ring cannot be moved smoothly by the constant-pressure preloading and the preload variable spindle, the same phenomenon as in the case of the position preloading is generated, and an excessive preload is applied to the bearing.

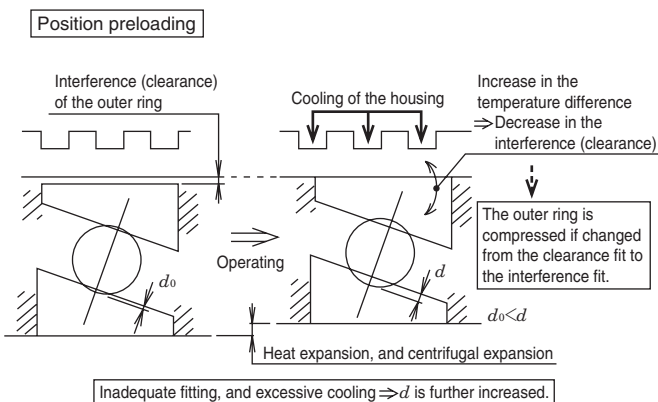

Fig. 1.1 Cause of increase in preload

Case ② Entry of foreign particle

Major foreign particles are as follows.

- Coolant
- Chippings
- Iron chips (housing material)

Causes

1) Poor sealing performance

If the labyrinth is not adequately configured for use conditions, the sufficient sealing effect is not obtained, and the foreign particles, including coolant, may be trapped in the bearing.

2) Part not cleaned sufficiently

If the parts are not cleaned sufficiently, small burrs and barbs exist, they may fall into the inside of the bearing during the operation.

3) Dirty lubricant

If the oil lubricant is not completely washed out of the pipe, or if the environment for the enclosing grease is not adequate, foreign particles may be trapped in the lubricant and the bearing may be damaged.

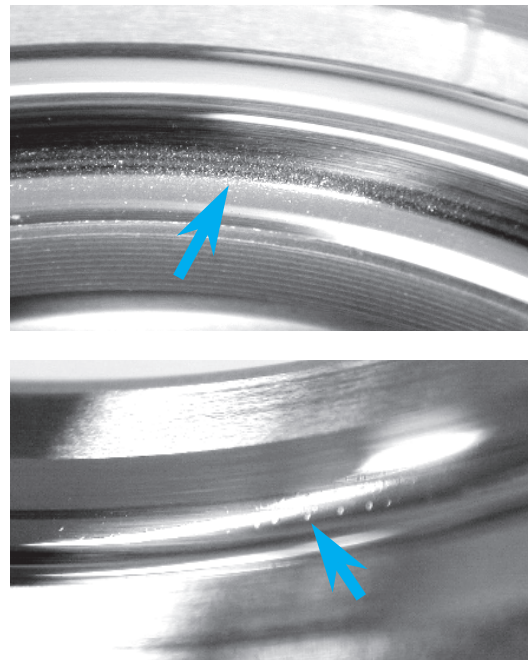

Fig. 1.2 Example of biting flaws formed in raceway because of entry of foreign particle

Case ③ Damage on the raceway surface (nick and flaking)

Causes

1) Nick

Nick may be produced on the raceway surface if the main shaft is hit, any excessive load is applied to the bearing because of the clamping and unclamping of the tool, or the bearing is not properly handled.

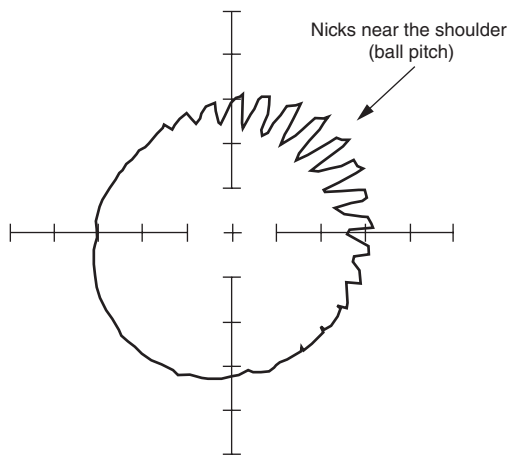

Fig. 1. 3 Example of nicks

2) Flaking

As the bearing becomes old, the flaking occurs if the load is applied repeatedly to the raceway surface.

However, even in case of a new bearing, the flaking may occur if an excessive load is applied to the bearing or the oil film is formed insufficiently.

Also, the flaking may be generated by the brinelling (nicks).

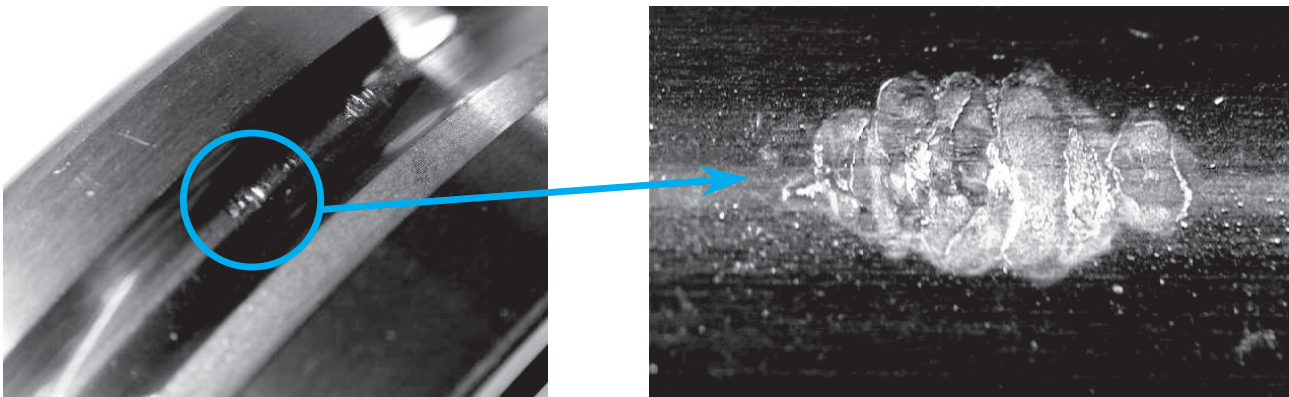

Fig. 1. 4 Example of flaking



V . Supplementary Tables

Contents	Page
1. Shaft tolerances	208
2. Housing bore tolerances	210
3. Numerical values for standard tolerance grades IT	212
4. Steel hardness conversion	213
5. SI units and conversion factors	214
6. Lubrication (discharge) intervals of the oil / air.....	219
7. Specification report	220

Supplementary table 1 Shaft tolerances (deviation from nominal dimensions)

Unit : μm

Nominal shaft dia. (mm)		Deviation classes of shaft diameter																									Nominal shaft dia. (mm)								
over	up to	g4	g5	g6	h4	h5	h6	h7	js3	js4	js5	js6	js7	j5	j6	j7	k3	k4	k5	k6	k7	m4	m5	m6	m7	n4	n5	n6	p6	r5	r6	r7	over	up to	
3	6	-4	-4	-4	0	0	0	0	± 1.2	± 2	± 2.5	± 4	± 6	+3	+6	+8	+2.5	+5	+6	+9	+13	+8	+9	+12	+16	+12	+13	+16	+20	+20	+23	+27	3	6	
		-8	-9	-12	-4	-5	-8	-12						-2	-2	-4	0	+1	+1	+1	+1	+4	+4	+4	+4	+8	+8	+8	+12	+15	+15	+15			
6	10	-5	-5	-5	0	0	0	0	± 1.2	± 2	± 3	± 4.5	± 7.5	+4	+7	+10	+2.5	+5	+7	+10	+16	+10	+12	+15	+21	+14	+16	+19	+24	+25	+28	+34	6	10	
		-9	-11	-14	-4	-6	-9	-15						-2	-2	-5	0	+1	+1	+1	+1	+6	+6	+6	+6	+10	+10	+10	+15	+19	+19	+19			
10	18	-6	-6	-6	0	0	0	0	± 1.5	± 2.5	± 4	± 5.5	± 9	+5	+8	+12	+3	+6	+9	+12	+19	+12	+15	+18	+25	+17	+20	+23	+29	+31	+34	+41	10	18	
		-11	-14	-17	-5	-8	-11	-18						-3	-3	-6	0	+1	+1	+1	+1	+7	+7	+7	+7	+12	+12	+12	+18	+23	+23	+23			
18	30	-7	-7	-7	0	0	0	0	± 2	± 3	± 4.5	± 6.5	± 10.5	+5	+9	+13	+4	+8	+11	+15	+23	+14	+17	+21	+29	+21	+24	+28	+35	+37	+41	+49	18	30	
		-13	-16	-20	-6	-9	-13	-21						-4	-4	-8	0	+2	+2	+2	+2	+8	+8	+8	+8	+15	+15	+15	+22	+28	+28	+28			
30	50	-9	-9	-9	0	0	0	0	± 2	± 3.5	± 5.5	± 8	± 12.5	+6	+11	+15	+4	+9	+13	+18	+27	+16	+20	+25	+34	+24	+28	+33	+42	+45	+50	+59	30	50	
		-16	-20	-25	-7	-11	-16	-25						-5	-5	-10	0	+2	+2	+2	+2	+9	+9	+9	+9	+17	+17	+17	+26	+34	+34	+34			
50	80	-10	-10	-10	0	0	0	0	± 2.5	± 4	± 6.5	± 9.5	± 15	+6	+12	+18	+5	+10	+15	+21	+32	+19	+24	+30	+41	+28	+33	+39	+51	+54	+60	+71	50	65	
		-18	-23	-29	-8	-13	-19	-30						-7	-7	-12	0	+2	+2	+2	+2	+11	+11	+11	+11	+20	+20	+20	+32	+41	+41	+41			
80	120	-12	-12	-12	0	0	0	0	± 3	± 5	± 7.5	± 11	± 17.5	+6	+13	+20	+6	+13	+18	+25	+38	+23	+28	+35	+48	+33	+38	+45	+59	+66	+73	+86	80	100	
		-22	-27	-34	-10	-15	-22	-35						-9	-9	-15	0	+3	+3	+3	+3	+13	+13	+13	+13	+23	+23	+23	+37	+45	+51	+51	+51		
120	180	-14	-14	-14	0	0	0	0	± 4	± 6	± 9	± 12.5	± 20	+7	+14	+22	+8	+15	+21	+28	+43	+27	+33	+40	+55	+39	+45	+52	+68	+83	+90	+103	120	140	
		-26	-32	-39	-12	-18	-25	-40						-11	-11	-18	0	+3	+3	+3	+3	+15	+15	+15	+15	+27	+27	+27	+43	+54	+65	+65	+65		
180	250	-15	-15	-15	0	0	0	0	± 5	± 7	± 10	± 14.5	± 23	+7	+16	+25	+10	+18	+24	+33	+50	+31	+37	+46	+63	+45	+51	+60	+79	+100	+109	+126	180	200	
		-29	-35	-44	-14	-20	-29	-46						-13	-13	-21	0	+4	+4	+4	+4	+17	+17	+17	+17	+31	+31	+31	+50	+80	+80	+80			
250	315	-17	-17	-17	0	0	0	0	± 6	± 8	± 11.5	± 16	± 26	+7	+16	+26	+12	+20	+27	+36	+56	+36	+43	+52	+72	+50	+57	+66	+88	+117	+126	+146	250	280	
		-33	-40	-49	-16	-23	-32	-52						-16	-16	-26	0	+4	+4	+4	+4	+20	+20	+20	+20	+34	+34	+34	+56	+94	+94	+94			
315	400	-18	-18	-18	0	0	0	0	± 6.5	± 9	± 12.5	± 18	± 28.5	+7	+18	+29	+13	+22	+29	+40	+61	+39	+46	+57	+78	+55	+62	+73	+98	+133	+144	+165	315	355	
		-36	-43	-54	-18	-25	-36	-57						-18	-18	-28	0	+4	+4	+4	+4	+21	+21	+21	+21	+37	+37	+37	+62	+108	+108	+108			
400	500	-20	-20	-20	0	0	0	0	± 7.5	± 10	± 13.5	± 20	± 31.5	+7	+20	+31	+15	+25	+32	+45	+68	+43	+50	+63	+86	+60	+67	+80	+108	+153	+166	+189	400	450	
		-40	-47	-60	-20	-27	-40	-63						-20	-20	-32	0	+5	+5	+5	+5	+23	+23	+23	+23	+40	+40	+40	+68	+126	+126	+126			
500	630	—	—	-22	—	—	0	0	—	—	—	± 22	± 35	—	—	—	—	—	—	+44	+70	—	—	+70	+96	—	—	+88	+122	+194	+220	500	560		
		—	—	-66	—	—	-44	-70	—	—	—			—	—	—	0	0	0	0	0	0	0	+26	+26	—	—	+44	+78	+150	+150				
630	800	—	—	-24	—	—	0	0	—	—	—	± 25	± 40	—	—	—	—	—	—	+50	+80	—	—	+80	+110	—	—	+100	+138	+225	+255	630	710		
		—	—	-74	—	—	-50	-80	—	—	—			—	—	—	0	0	0	0	0	0	0	+30	+30	—	—	+50	+88	+175	+175				
800	1 000	—	—	-26	—	—	0	0	—	—	—	± 28	± 45	—	—	—	—	—	—	+56	+90	—	—	+90	+124	—	—	+112	+156	+266	+300	800	900		
		—	—	-82	—	—	-56	-90	—	—	—			—	—	—	0	0	0	0	0	0	0	+34	+34	—	—	+56	+100	+210	+210				
																													+276	+310	+276	+310	900	1 000	
																													+220	+220	+220	+220			

Supplementary table 2 Housing bore tolerances (deviation from nominal dimensions)

Unit : μm

Nominal bore dia. (mm)		Deviation classes of housing bore diameter																												Nominal bore dia. (mm)			
over	up to	G5	G6	G7	H4	H5	H6	H7	H8	JS4	JS5	JS6	JS7	J6	J7		K4	K5	K6	K7	M4	M5	M6	M7	N4	N5	N6	N7	P5	P6	P7	over	up to
10	18	+14 + 6	+17 + 6	+ 24 + 6	+ 5 0	+ 8 0	+11 0	+18 0	+27 0	± 2.5	± 4	± 5.5	± 9	+ 6 - 5	+10 - 8		+ 1 - 4	+ 2 - 6	+ 2 - 9	+ 6 -12	- 5 -10	- 4 -12	- 4 -15	0 -18	-10 -15	- 9 -17	- 9 -20	- 5 -23	-15 -23	-15 -26	-11 -29	10	18
18	30	+16 + 7	+20 + 7	+ 28 + 7	+ 6 0	+ 9 0	+13 0	+21 0	+33 0	± 3	± 4.5	± 6.5	± 10.5	+ 8 - 5	+12 - 9		0 - 6	+ 1 - 8	+ 2 -11	+ 6 -15	- 6 -12	- 5 -14	- 4 -17	0 -21	-13 -19	-12 -21	-11 -24	- 7 -28	-19 -28	-18 -31	-14 -35	18	30
30	50	+20 + 9	+25 + 9	+ 34 + 9	+ 7 0	+11 0	+16 0	+25 0	+39 0	± 3.5	± 5.5	± 8	± 12.5	+10 - 6	+14 -11		+ 1 - 6	+ 2 - 9	+ 3 -13	+ 7 -18	- 6 -13	- 5 -16	- 4 -20	0 -25	-14 -21	-13 -24	-12 -28	- 8 -33	-22 -33	-21 -37	-17 -42	30	50
50	80	+23 +10	+29 +10	+ 40 +10	+ 8 0	+13 0	+19 0	+30 0	+46 0	± 4	± 6.5	± 9.5	± 15	+13 - 6	+18 -12		+ 1 - 7	+ 3 -10	+ 4 -15	+ 9 -21	- 8 -16	- 6 -19	- 5 -24	0 -30	-17 -25	-15 -28	-14 -33	- 9 -39	-27 -40	-26 -45	-21 -51	50	65
80	120	+27 +12	+34 +12	+ 47 +12	+10 0	+15 0	+22 0	+35 0	+54 0	± 5	± 7.5	± 11	± 17.5	+16 - 6	+22 -13		+ 1 - 9	+ 2 -13	+ 4 -18	+10 -25	- 9 -19	- 8 -23	- 6 -28	0 -35	-19 -29	-18 -33	-16 -38	-10 -45	-32 -47	-30 -52	-24 -59	80	100
120	180	+32 +14	+39 +14	+ 54 +14	+12 0	+18 0	+25 0	+40 0	+63 0	± 6	± 9	± 12.5	± 20	+18 - 7	+26 -14		+ 1 -11	+ 3 -15	+ 4 -21	+12 -28	-11 -23	- 9 -27	- 8 -33	0 -40	-23 -35	-21 -39	-20 -45	-12 -52	-37 -55	-36 -61	-28 -68	120	140
180	250	+35 +15	+44 +15	+ 61 +15	+14 0	+20 0	+29 0	+46 0	+72 0	± 7	± 10	± 14.5	± 23	+22 - 7	+30 -16		0 -14	+ 2 -18	+ 5 -24	+13 -33	-13 -27	-11 -31	- 8 -37	0 -46	-27 -41	-25 -45	-22 -51	-14 -60	-44 -64	-41 -70	-33 -79	180	200
250	315	+40 +17	+49 +17	+ 69 +17	+16 0	+23 0	+32 0	+52 0	+81 0	± 8	± 11.5	± 16	± 26	+25 - 7	+36 -16		0 -16	+ 3 -20	+ 5 -27	+16 -36	-16 -32	-13 -36	- 9 -41	0 -52	-30 -46	-27 -50	-25 -57	-14 -66	-49 -72	-47 -79	-36 -88	250	280
315	400	+43 +18	+54 +18	+ 75 +18	+18 0	+25 0	+36 0	+57 0	+89 0	± 9	± 12.5	± 18	± 28.5	+29 - 7	+39 -18		+ 1 -17	+ 3 -22	+ 7 -29	+17 -40	-16 -34	-14 -39	-10 -46	0 -57	-32 -50	-30 -55	-26 -62	-16 -73	-55 -80	-51 -87	-41 -98	315	355
400	500	+47 +20	+60 +20	+ 83 +20	+20 0	+27 0	+40 0	+63 0	+97 0	± 10	± 13.5	± 20	± 31.5	+33 - 7	+43 -20		0 -20	+ 2 -25	+ 8 -32	+18 -45	-18 -38	-16 -43	-10 -50	0 -63	-35 -55	-33 -60	-27 -67	-17 -80	-61 -88	-55 -95	-45 -108	400	450
500	630	—	+66 +22	+ 92 +22	—	—	+44 0	+70 0	+110 0	—	—	± 22	± 35	—	—		—	—	0 -44	0 -70	—	—	-26 -70	-26 -96	—	—	-44 -88	-44 -114	—	-78 -122	-78 -148	500	560
630	800	—	+74 +24	+104 +24	—	—	+50 0	+80 0	+125 0	—	—	± 25	± 40	—	—		—	—	0 -50	0 -80	—	—	-30 -80	-30 -110	—	—	-50 -100	-50 -130	—	-88 -138	-88 -168	630	710
800	1 000	—	+82 +26	+116 +26	—	—	+56 0	+90 0	+140 0	—	—	± 28	± 45	—	—		—	—	0 -56	0 -90	—	—	-34 -90	-34 -124	—	—	-56 -112	-56 -146	—	-100 -156	-100 -190	800	900
1 000	1 250	—	+94 +28	+133 +28	—	—	+66 0	+105 0	+165 0	—	—	± 33	± 52.5	—	—		—	—	0 -66	0 -105	—	—	-40 -106	-40 -145	—	—	-66 -132	-66 -171	—	-120 -186	-120 -225	1 000	1 250

Supplementary table 3 Numerical values for standard tolerance grades IT (ISO 286-1)

Basic size (mm)		Standard tolerance grades (IT)																	
		1	2	3	4	5	6	7	8	9	10	11	12	13	14 ¹⁾	15 ¹⁾	16 ¹⁾	17 ¹⁾	18 ¹⁾
over	up to	Tolerances (µm)											Tolerances (mm)						
—	3	0.8	1.2	2	3	4	6	10	14	25	40	60	0.10	0.14	0.26	0.40	0.60	1.00	1.40
3	6	1	1.5	2.5	4	5	8	12	18	30	48	75	0.12	0.18	0.30	0.48	0.75	1.20	1.80
6	10	1	1.5	2.5	4	6	9	15	22	36	58	90	0.15	0.22	0.36	0.58	0.90	1.50	2.20
10	18	1.2	2	3	5	8	11	18	27	43	70	110	0.18	0.27	0.43	0.70	1.10	1.80	2.70
18	30	1.5	2.5	4	6	9	13	21	33	52	84	130	0.21	0.33	0.52	0.84	1.30	2.10	3.30
30	50	1.5	2.5	4	7	11	16	25	39	62	100	160	0.25	0.39	0.62	1.00	1.60	2.50	3.90
50	80	2	3	5	8	13	19	30	46	74	120	190	0.30	0.46	0.74	1.20	1.90	3.00	4.60
80	120	2.5	4	6	10	15	22	35	54	87	140	220	0.35	0.54	0.87	1.40	2.20	3.50	5.40
120	180	3.5	5	8	12	18	25	40	63	100	160	250	0.40	0.63	1.00	1.60	2.50	4.00	6.30
180	250	4.5	7	10	14	20	29	46	72	115	185	290	0.46	0.72	1.15	1.85	2.90	4.60	7.20
250	315	6	8	12	16	23	32	52	81	130	210	320	0.52	0.81	1.30	2.10	3.20	5.20	8.10
315	400	7	9	13	18	25	36	57	89	140	230	360	0.57	0.89	1.40	2.30	3.60	5.70	8.90
400	500	8	10	15	20	27	40	63	97	155	250	400	0.63	0.97	1.55	2.50	4.00	6.30	9.70
500	630	—	—	—	—	—	44	70	110	175	280	440	0.70	1.10	1.75	2.80	4.40	7.00	11.00
630	800	—	—	—	—	—	50	80	125	200	320	500	0.80	1.25	2.00	3.20	5.00	8.00	12.50
800	1 000	—	—	—	—	—	56	90	140	230	360	560	0.90	1.40	2.30	3.60	5.60	9.00	14.00
1 000	1 250	—	—	—	—	—	66	105	165	260	420	660	1.05	1.65	2.60	4.20	6.60	10.50	16.50
1 250	1 600	—	—	—	—	—	78	125	195	310	500	780	1.25	1.95	3.10	5.00	7.80	12.50	19.50
1 600	2 000	—	—	—	—	—	92	150	230	370	600	920	1.50	2.30	3.70	6.00	9.20	15.00	23.00
2 000	2 500	—	—	—	—	—	110	175	280	440	700	1 100	1.75	2.80	4.40	7.00	11.00	17.50	28.00
2 500	3 150	—	—	—	—	—	135	210	330	540	860	1 350	2.10	3.30	5.40	8.60	13.50	21.00	33.00

[Note] 1) Standard tolerance grades IT 14 to IT 18 (incl.) shall not be used for basic sizes less than or equal to 1 mm.

Supplementary table 4 Steel hardness conversion

Rockwell C-scale 1 471.0 N(150 kgf)	Vicker's	Brinell		Rockwell		Shore
		Standard ball	Tungsten carbide ball	A-scale 588.4 N(60 kgf)	B-scale 980.7 N(100 kgf)	
68	940			85.6		97
67	900			85.0		95
66	865			84.5		92
65	832		739	83.9		91
64	800		722	83.4		88
63	772		705	82.8		87
62	746		688	82.3		85
61	720		670	81.8		83
60	697		654	81.2		81
59	674		634	80.7		80
58	653		615	80.1		78
57	633		595	79.6		76
56	613		577	79.0		75
55	595	—	560	78.5		74
54	577	—	543	78.0		72
53	560	—	525	77.4		71
52	544	500	512	76.8		69
51	528	487	496	76.3		68
50	513	475	481	75.9		67
49	498	464	469	75.2		66
48	484	451	455	74.7		64
47	471	442	443	74.1		63
46	458		432	73.6		62
45	446		421	73.1		60
44	434		409	72.5		58
43	423		400	72.0		57
42	412		390	71.5		56
41	402		381	70.9		55
40	392		371	70.4	—	54
39	382		362	69.9	—	52
38	372		353	69.4	—	51
37	363		344	68.9	—	50
36	354		336	68.4	(109.0)	49
35	345		327	67.9	(108.5)	48
34	336		319	67.4	(108.0)	47
33	327		311	66.8	(107.5)	46
32	318		301	66.3	(107.0)	44
31	310		294	65.8	(106.0)	43
30	302		286	65.3	(105.5)	42
29	294		279	64.7	(104.5)	41
28	286		271	64.3	(104.0)	41
27	279		264	63.8	(103.0)	40
26	272		258	63.3	(102.5)	38
25	266		253	62.8	(101.5)	38
24	260		247	62.4	(101.0)	37
23	254		243	62.0	100.0	36
22	248		237	61.5	99.0	35
21	243		231	61.0	98.5	35
20	238		226	60.5	97.8	34
(18)	230		219	—	96.7	33
(16)	222		212	—	95.5	32
(14)	213		203	—	93.9	31
(12)	204		194	—	92.3	29
(10)	196		187		90.7	28
(8)	188		179		89.5	27
(6)	180		171		87.1	26
(4)	173		165		85.5	25
(2)	166		158		83.5	24
(0)	160		152		81.7	24

Supplementary table 5(1) SI units and conversion factors

Mass	SI units	Other units ¹⁾	Conversion into SI units	Conversion from SI units
Angle	rad [radian(s)]	° [degree(s)] * ' [minute(s)] * " [second(s)] *	1° = $\pi/180$ rad 1' = $\pi/10\ 800$ rad 1" = $\pi/648\ 000$ rad	1 rad = 57.295 78°
Length	m [meter(s)]	Å [Angstrom unit] μ [micron(s)] in [inch(es)] ft [foot(feet)] yd [yard(s)] mile [mile(s)]	1Å = 10^{-10} m = 0.1 nm = 100 pm 1μ = 1 μm 1in = 25.4 mm 1ft = 12 in = 0.304 8 m 1yd = 3 ft = 0.914 4 m 1mile = 5 280 ft = 1 609.344 m	1m = 10^{10} Å 1m = 39.37 in 1m = 3.280 8 ft 1m = 1.093 6 yd 1km = 0.621 4 mile
Area	m ²	a [are(s)] ha [hectare(s)] acre [acre(s)]	1a = 100 m ² 1ha = 10 ⁴ m ² 1acre = 4 840 yd ² = 4 046.86 m ²	1km ² = 247.1 acre
Volume	m ³	ℓ , L [liter(s)] * cc [cubic centimeters] gal(US) [gallon(s)] froz(US) [fluid ounce(s)] barrel(US) [barrels(US)]	1ℓ = 1 dm ³ = 10 ⁻³ m ³ 1cc = 1 cm ³ = 10 ⁻⁶ m ³ 1gal(US) = 231 in ³ = 3.785 41dm ³ 1froz(US) = 29.573 5 cm ³ 1barrel(US) = 158.987 dm ³	1m ³ = 10 ³ ℓ 1m ³ = 10 ⁶ cc 1m ³ = 264.17 gal 1m ³ = 33 814 froz 1m ³ = 6.289 8 barrel
Time	s [second(s)]	min [minute(s)] * h [hour(s)] * d [day(s)] *		
Angular velocity	rad / s			
Velocity	m / s	kn [knot(s)] * m / h *	1kn = 1 852 m / h	1km / h = 0.539 96 kn
Acceleration	m / s ²	G	1G = 9.806 65 m / s ²	1m / s ² = 0.101 97 G
Frequency	Hz [hertz]	c / s [cycle(s)/second]	1c / s = 1s ⁻¹ = 1 Hz	
Rotational frequency	s ⁻¹	rpm [revolutions per minute] * min ⁻¹ * r / min	1rpm = 1 / 60 s ⁻¹	1s ⁻¹ = 60 rpm
Mass	kg [kilogram(s)]	t [ton(s)] * lb [pound(s)] * gr [grain(s)] * oz [ounce(s)] * ton (UK) [ton(s) (UK)] * ton (US) [ton(s) (US)] * car [carat(s)] *	1t = 10 ³ kg 1lb = 0.453 592 37 kg 1gr = 64.798 91 mg 1oz = 1/16 lb = 28.349 5 g 1ton(UK) = 1 016.05 kg 1ton(US) = 907.185 kg 1car = 200 mg	1kg = 2.204 6 lb 1g = 15.432 4 gr 1kg = 35.274 0 oz 1t = 0.984 2 ton (UK) 1t = 1.102 3 ton (US) 1g = 5 car

[Notes] 1) * : Unit can be used as an SI unit.
No asterisk : Unit cannot be used.

Supplementary table 5(2) SI units and conversion factors

Mass	SI units	Other units ¹⁾	Conversion into SI units	Conversion from SI units
Density	kg / m ³			
Linear density	kg / m			
Momentum	kg·m / s			
Moment of momentum, angular momentum	} kg·m ² / s			
Moment of inertia		kg·m ²		
Force	N [newton(s)]	dyn [dyne(s)] kgf [kilogram-force] gf [gram-force] tf [ton-force] lbf [pound-force]	1 dyn = 10 ⁻⁵ N 1 kgf = 9.806 65 N 1 gf = 9.806 65 × 10 ⁻³ N 1 tf = 9.806 65 × 10 ³ N 1 lbf = 4.448 22 N	1 N = 10 ⁵ dyn 1 N = 0.101 97 kgf 1 N = 0.224 809 lbf
Moment of force	N·m [Newton meter(s)]	gf·cm kgf·cm kgf·m tf·m lbf·ft	1 gf·cm = 9.806 65 × 10 ⁻⁵ N·m 1 kgf·cm = 9.806 65 × 10 ⁻² N·m 1 kgf·m = 9.806 65 N·m 1 tf·m = 9.806 65 × 10 ³ N·m 1 lbf·ft = 1.355 82 N·m	1 N·m = 0.101 97 kgf·m 1 N·m = 0.737 56 lbf·ft
Pressure, Normal stress	Pa [Pascal(s)] or N / m ² {1 Pa = 1 N / m ² }	gf / cm ² kgf / mm ² kgf / m ² lbf / in ² bar [bar(s)] at [engineering air pressure] mH ₂ O, mAq [meter water column] atm [atmosphere] mHg [meter mercury column] Torr [torr]	1 gf / cm ² = 9.806 65 × 10 Pa 1 kgf / mm ² = 9.806 65 × 10 ⁶ Pa 1 kgf / m ² = 9.806 65 Pa 1 lbf / in ² = 6 894.76 Pa 1 bar = 10 ⁵ Pa 1 at = 1 kgf / cm ² = 9.806 65 × 10 ⁴ Pa 1 mH ₂ O = 9.806 65 × 10 ³ Pa 1 atm = 101 325 Pa 1 mHg = $\frac{101\ 325}{0.76}$ Pa 1 Torr = 1 mmHg = 133.322 Pa	1 MPa = 0.101 97 kgf / mm ² 1 Pa = 0.101 97 kgf / m ² 1 Pa = 0.145 × 10 ⁻³ lbf / in ² 1 Pa = 10 ⁻² mbar 1 Pa = 7.500 6 × 10 ⁻³ Torr
Viscosity	Pa·s [pascal second]	P [poise] kgf·s / m ²	10 ⁻² P = 1 cP = 1 mPa·s 1 kgf·s / m ² = 9.806 65 Pa·s	1 Pa·s = 0.101 97 kgf·s / m ²
Kinematic viscosity	m ² / s	St [stokes]	10 ⁻² St = 1 cSt = 1 mm ² / s	
Surface tension	N / m			

Supplementary table 5(3) SI units and conversion factors

Mass	SI units	Other units ¹⁾	Conversion into SI units	Conversion from SI units
Work, energy	J [joule(s)] {1 J = 1 N·m}	eV [electron volt(s)] * erg [erg(s)] kgf·m lbf·ft	1eV = (1.602 189 2±0.000 004 6)×10 ⁻¹⁹ J 1 erg = 10 ⁻⁷ J 1 kgf·m = 9.806 65 J 1 lbf·ft = 1.355 82 J	1 J = 10 ⁷ erg 1 J = 0.101 97 kgf·m 1 J = 0.737 56 lbf·ft
Power	W [watt(s)]	erg / s [ergs per second] kgf·m / s PS [French horse-power] HP [horse-power (British)] lbf·ft / s	1 erg / s = 10 ⁻⁷ W 1 kgf·m / s = 9.806 65 W 1 PS = 75 kgf·m / s = 735.5 W 1 HP = 550 lbf·ft / s = 745.7 W 1 lbf·ft / s = 1.355 82 W	1 W = 0.101 97 kgf·m / s 1 W = 0.001 36 PS 1 W = 0.001 34 HP
Thermo-dynamic temperature	K [kelvin(s)]			
Celsius temperature	°C [Celsius(s)] {t°C = (t+273.15)K}	°F [degree(s) Fahrenheit]	t °F = $\frac{5}{9}(t-32)°C$	t °C = $(\frac{9}{5}t+32)°F$
Linear expansion coefficient	K ⁻¹	°C ⁻¹ [per degree]		
Heat	J [joule(s)] {1 J = 1 N·m}	erg [erg(s)] kgf·m cal _{IT} [I. T. calories]	1 erg = 10 ⁻⁷ J 1 cal _{IT} = 4.186 8 J 1 Mcal _{IT} = 1.163 kW·h	1 J = 10 ⁷ erg 1 J = 0.238 85 cal _{IT} 1 kW·h = 0.86×10 ⁶ cal _{IT}
Thermal conductivity	W / (m·K)	W / (m·°C) cal / (s·m·°C)	1 W / (m·°C) = 1 W / (m·K) 1 cal / (s·m·°C) = 4.186 05 W / (m·K)	
Coefficient of heat transfer	W / (m ² ·K)	W / (m ² ·°C) cal / (s·m ² ·°C)	1 W / (m ² ·°C) = 1 W / (m ² ·K) 1 cal / (s·m ² ·°C) = 4.186 05 W / (m ² ·K)	
Heat capacity	J / K	J / °C	1 J / °C = 1 J / K	
Massic heat capacity	J / (kg·K)	J / (kg·°C)		

[Notes] 1) * : Unit can be used as an SI unit.
No asterisk : Unit cannot be used.

Supplementary table 5(4) SI units and conversion factors

Mass	SI units	Other units ¹⁾	Conversion into SI units	Conversion from SI units
Electric current	A [ampere(s)]			
Electric charge, quantity of electricity	C [coulomb(s)] {1 C = 1 A·s}	A·h *	1 A·h = 3.6 kC	
Tension, electric potential	V [volt(s)] {1 V = 1 W / A}			
Capacitance	F [farad(s)] {1 F = 1 C / V}			
Magnetic field strength	A / m	Oe [oersted(s)]	$1 \text{ Oe} = \frac{10^3}{4\pi} \text{ A / m}$	$1 \text{ A / m} = 4\pi \times 10^{-3} \text{ Oe}$
Magnetic flux density	T [tesla(s)] { $1 \text{ T} = 1 \text{ N} / (\text{A} \cdot \text{m})$ $= 1 \text{ Wb} / \text{m}^2$ $= 1 \text{ V} \cdot \text{s} / \text{m}^2$ }	Gs [gauss(es)] γ [gamma(s)]	$1 \text{ Gs} = 10^{-4} \text{ T}$ $1 \gamma = 10^{-9} \text{ T}$	$1 \text{ T} = 10^4 \text{ Gs}$ $1 \text{ T} = 10^9 \gamma$
Magnetic flux	Wb [weber(s)] {1 Wb = 1 V·s}	Mx [maxwell(s)]	$1 \text{ Mx} = 10^{-8} \text{ Wb}$	$1 \text{ Wb} = 10^8 \text{ Mx}$
Self inductance	H [henry(-ries)] {1 H = 1 Wb / A}			
Resistance (to direct current)	Ω [ohm(s)] {1 Ω = 1 V / A}			
Conductance (to direct current)	S [siemens] {1 S = 1 A / V}			
Active power	W { $1 \text{ W} = 1 \text{ J} / \text{s}$ $= 1 \text{ A} \cdot \text{V}$ }			

[Refer.] Principal units conversion table

Force

N	dyn	kgf
1	1×10^5	$1.019\ 72 \times 10^{-1}$
1×10^{-5}	1	$1.019\ 72 \times 10^{-6}$
9.806 65	$9.806\ 65 \times 10^5$	1

Torque

N·m	mN·m	$\mu\text{N}\cdot\text{m}$	kgf·m	kgf·cm	gf·cm
1	1×10^3	1×10^6	$1.019\ 72 \times 10^{-1}$	$1.019\ 72 \times 10$	$1.019\ 72 \times 10^4$
1×10^{-3}	1	1×10^3	$1.019\ 72 \times 10^{-4}$	$1.019\ 72 \times 10^{-2}$	$1.019\ 72 \times 10$
1×10^{-6}	1×10^{-3}	1	$1.019\ 72 \times 10^{-7}$	$1.019\ 72 \times 10^{-5}$	$1.019\ 72 \times 10^{-2}$
9.806 65	$9.806\ 65 \times 10^3$	$9.806\ 65 \times 10^6$	1	1×10^2	1×10^5
$9.806\ 65 \times 10^{-2}$	$9.806\ 65 \times 10$	$9.806\ 65 \times 10^4$	1×10^{-2}	1	1×10^3
$9.806\ 65 \times 10^{-5}$	$9.806\ 65 \times 10^{-2}$	$9.806\ 65 \times 10$	1×10^{-5}	1×10^{-3}	1

Stress

Pa or N/m ²	MPa or N/mm ²	kgf/mm ²	kgf/cm ²
1	1×10^{-6}	$1.019\ 72 \times 10^{-7}$	$1.019\ 72 \times 10^{-5}$
1×10^6	1	$1.019\ 72 \times 10^{-1}$	$1.019\ 72 \times 10$
$9.806\ 65 \times 10^6$	9.806 65	1	1×10^2
$9.806\ 65 \times 10^4$	$9.806\ 65 \times 10^{-2}$	1×10^{-2}	1

[Note] 1 Pa=1 N/m², 1 MPa=1 N/mm²

Pressure

Pa	kPa	MPa	bar	kgf/cm ²	atm	mmH ₂ O	mmHg or Torr
1	1×10^{-3}	1×10^{-6}	1×10^{-5}	$1.019\ 72 \times 10^{-5}$	$9.869\ 23 \times 10^{-6}$	$1.019\ 72 \times 10^{-1}$	$7.500\ 62 \times 10^{-3}$
1×10^3	1	1×10^{-3}	1×10^{-2}	$1.019\ 72 \times 10^{-2}$	$9.869\ 23 \times 10^{-3}$	$1.019\ 72 \times 10^2$	7.500 62
1×10^6	1×10^3	1	1×10	$1.019\ 72 \times 10$	9.869 23	$1.019\ 72 \times 10^5$	$7.500\ 62 \times 10^3$
1×10^5	1×10^2	1×10^{-1}	1	1.019 72	$9.869\ 23 \times 10^{-1}$	$1.019\ 72 \times 10^4$	$7.500\ 62 \times 10^2$
$9.806\ 65 \times 10^4$	$9.806\ 65 \times 10$	$9.806\ 65 \times 10^{-2}$	$9.806\ 65 \times 10^{-1}$	1	$9.678\ 41 \times 10^{-1}$	1×10^4	$7.355\ 59 \times 10^2$
$1.013\ 25 \times 10^5$	$1.013\ 25 \times 10^2$	$1.013\ 25 \times 10^{-1}$	1.013 25	1.033 23	1	$1.033\ 23 \times 10^4$	$7.600\ 00 \times 10^2$
9.806 65	$9.806\ 65 \times 10^{-3}$	$9.806\ 65 \times 10^{-6}$	$9.806\ 65 \times 10^{-5}$	1×10^{-4}	$9.678\ 41 \times 10^{-5}$	1	$7.355\ 59 \times 10^{-2}$
$1.333\ 22 \times 10^2$	$1.333\ 22 \times 10^{-1}$	$1.333\ 22 \times 10^{-4}$	$1.333\ 22 \times 10^{-3}$	$1.359\ 51 \times 10^{-3}$	$1.315\ 79 \times 10^{-3}$	$1.359\ 51 \times 10$	1

[Note] 1 Pa=1 N/m²

Kinematic viscosity

m ² /s	cSt	St
1	1×10^6	1×10^4
1×10^{-6}	1	1×10^{-2}
1×10^{-4}	1×10^2	1

[Note] 1 cSt=1 mm²/s, 1 St=1 cm²/s

Supplementary table 6 Lubrication (discharge) intervals of the oil / air

Preloading method	Material of rolling element	Oil viscosity	$d_m n$ value ($\times 10^4$)																			
			over	—	70	85	100	125	150	175	200	225	250									
			up to	70	85	100	125	150	175	200	225	250										
Position preloading	Bearing steel (SUJ2)	ISO VG10	Standard	5-10 Minute	3-8 Minute		2-6 Minute		Consult JTEKT.													
			High Ability	5-10 Minute		3-8 Minute		2-6 Minute														
		ISO VG22	Standard	6-12 Minute	4-10 Minute		3-6 Minute															
			High Ability	6-12 Minute		4-10 Minute		3-6 Minute														
		ISO VG32	Standard	10-18 Minute	6-15 Minute		4-12 Minute															
			High Ability	10-18 Minute		6-15 Minute		4-12 Minute														
	Ceramics (Si_3N_4)	ISO VG10	Standard	4-10 Minute		2-8 Minute		1-5 Minute						Consult JTEKT.								
			High Ability	4-10 Minute		2-8 Minute		1-5 Minute														
		ISO VG22	Standard	6-12 Minute		4-10 Minute		3-6 Minute														
			High Ability	6-12 Minute		4-10 Minute		3-6 Minute														
		ISO VG32	Standard	10-18 Minute		6-15 Minute		4-12 Minute														
			High Ability	10-18 Minute		6-15 Minute		4-12 Minute														
Constant-pressure preloading	Bearing steel (SUJ2)	ISO VG10	Standard	4-10 Minute		2-8 Minute		Consult JTEKT.														
			High Ability	4-10 Minute		2-8 Minute																
		ISO VG22	Standard	6-12 Minute		3-10 Minute							Consult JTEKT.									
			High Ability	6-12 Minute		3-10 Minute																
		ISO VG32	Standard	10-18 Minute		6-15 Minute										Consult JTEKT.						
			High Ability	10-18 Minute		6-15 Minute																
	Ceramics (Si_3N_4)	ISO VG10	Standard	4-10 Minute		2-8 Minute													1-5 Minute	1-3 Minute	Consult JTEKT.	
			High Ability	4-10 Minute		2-8 Minute													1-5 Minute	1-3 Minute		
		ISO VG22	Standard	6-12 Minute		3-10 Minute							2-6 Minute	2-4 Minute	1-3 Minute							
			High Ability	6-12 Minute		3-10 Minute							2-6 Minute	2-4 Minute	1-3 Minute							
		ISO VG32	Standard	10-18 Minute		6-15 Minute							3-10 Minute	2-6 Minute	2-5 Minute							
			High Ability	10-18 Minute		6-15 Minute							3-10 Minute	2-6 Minute	2-5 Minute							

- [Remarks]**
- The discharge intervals indicated are reference values supposing that the oil quantity of one discharge is 0.03ml in case of the angular contact ball bearing.
 - If the cylindrical roller bearing is used, suppose that the discharge interval is the same, and the oil quantity of one discharge is 0.01ml.
 - Select the optimal value of the required oil quantity by carrying out the test on the machine referring to the table above, because the optimal value varies depending on the type of the bearing, environment and use conditions.
 - ISO VG22 or VG32 is recommended in case of the main shaft driven by the built-in motor.

GLOBAL NETWORK

BEARING BUSINESS OPERATIONS

JTEKT CORPORATION NAGOYA HEAD OFFICE

No.7-1, Meieki 4-chome, Nakamura-ku, Nagoya, Aichi 450-8515,
JAPAN
TEL : 81-52-527-1900
FAX : 81-52-527-1911

JTEKT CORPORATION OSAKA HEAD OFFICE

No.5-8, Minamisemba 3-chome, Chuo-ku, Osaka 542-8502,
JAPAN
TEL : 81-6-6271-8451
FAX : 81-6-6245-7892

Sales & Marketing Headquarters

No.5-8, Minamisemba 3-chome, Chuo-ku, Osaka 542-8502,
JAPAN
TEL : 81-6-6245-6087
FAX : 81-6-6244-9007

OFFICES

KOYO CANADA INC.

5324 South Service Road, Burlington, Ontario L7L 5H5, CANADA
TEL : 1-905-681-1121
FAX : 1-905-681-1392

KOYO CORPORATION OF U.S.A.

-Cleveland Office-

29570 Clemens Road, P.O.Box 45028 Westlake,
OH 44145, U.S.A.
TEL : 1-440-835-1000
FAX : 1-440-835-9347

-Detroit Office-

47771 Halyard Drive, Plymouth, MI 48170, U.S.A.
TEL : 1-734-454-1500
FAX : 1-734-454-4076

KOYO MEXICANA, S.A. DE C.V.

Rio Nazas No.171, 3er piso, Col. Cuauhtemoc, México, D.F. C.P.
06500, MEXICO
TEL : 52-55-5207-3860
FAX : 52-55-5207-3873

KOYO LATIN AMERICA, S.A.

Edificio Banco del Pacifico Planta Baja, Calle Aquilino de la
Guardia y Calle 52, Panama, REPUBLICA DE PANAMA
TEL : 507-208-5900
FAX : 507-264-2782/507-269-7578

KOYO ROLAMENTOS DO BRASIL LTDA.

Rua Desembargador Eliseu Ghilherme 304, 7-Andar, Paraiso,
CEP 04004-30, BRASIL
TEL : 55-11-3887-9173
FAX : 55-11-3887-3039

JTEKT (THAILAND) Co., LTD.

172/1 Moo 12 Tambol Bangwua, Amphur Bangpakong,
Chachoengsao 24180, THAILAND
TEL : 66-38-533-310-7
FAX : 66-38-532-776

KOYO SINGAPORE BEARING (PTE.) LTD.

#09-01, C&P Logistics Hub 2, 27, Penjuru Lane, SINGAPORE,
609195
TEL : 65-6274-2200
FAX : 65-6862-1623

-MIDDLE EAST (BRANCH)-

6EA312, Dubai Airport Free Zone, P.O. Box 54816, Dubai, U.A.E.
TEL : 971-4-2993600
FAX : 971-4-2993700

PHILIPPINE KOYO BEARING CORPORATION

Rm.504, Comfoods Bldg., Cor. Gil Puyat Ave. and
Pasong Tamo, Makati City, PHILIPPINES
TEL : 63-2-817-8881/8901
FAX : 63-2-867-3148

JTEKT KOREA CO., LTD.

Inwoo Building 6F, 539-11, Shinsa-Dong,
Kangnam-Ku, Seoul, KOREA
TEL : 82-2-549-7922
FAX : 82-2-549-7923

JTEKT (CHINA) CO., LTD.

Rm.1906, Aetna Tower, 107 Zunyi Road, Shanghai, 200051,
CHINA
TEL : 86-21-6237-5280
FAX : 86-21-6237-5277

KOYO (SHANGHAI) CO., LTD.

Rm.1905, Aetna Tower, 107 Zunyi Road, Shanghai, 200051,
CHINA
TEL : 86-21-6237-5280
FAX : 86-21-6237-5277

KOYO AUSTRALIA PTY. LTD.

Unit 2, 8 Hill Road, Homebush Bay, NSW 2127, AUSTRALIA
TEL : 61-2-8719-5300
FAX : 61-2-8719-5333

JTEKT EUROPE BEARINGS B.V.

Markerkant 13-01, 1314 AN Almere, THE NETHERLANDS
TEL : 31-36-5383333
FAX : 31-36-5347212

KOYO KULLAGER SCANDINAVIA A.B.

Johanneslundsvägen 4, 194 61 Upplands Väsby, SWEDEN
TEL : 46-8-594-212-10
FAX : 46-8-594-212-29

KOYO (U.K.) LTD.

Whitehall Avenue, Kingston, Milton Keynes MK10 OAX,
UNITED KINGDOM
TEL : 44-1908-289300
FAX : 44-1908-289333

KOYO ROMANIA REPRESENTATIVE OFFICE

Str. Frederic Jolliot-Curie, Nr.3, Etaj 1, Ap.2, Sector 5
Bucharest, ROMANIA
TEL : 40-21-410-4170/4182/0984
FAX : 40-21-410-1178

KOYO DEUTSCHLAND GMBH.

Bargkoppelweg 4, D-22145 Hamburg, GERMANY
TEL : 49-40-67-9090-0
FAX : 49-40-67-9203-0

KOYO FRANCE S.A.

8 Rue Guy Moquet, B.P.189 Z.I., 95105 Argenteuil Cedex, FRANCE
TEL : 33-1-3998-4202
FAX : 33-1-3998-4244/4249

KOYO IBERICA, S.L.

Avda.da la Industria, 52-2 izda 28820
Coslada Madrid, SPAIN
TEL : 34-91-329-0818
FAX : 34-91-747-1194

KOYO ITALIA S.R.L.

Via Bronzino 9, 20133 Milano, ITALY
TEL : 39-02-2951-0844
FAX : 39-02-2951-0954

BEARING PLANTS

KOYO CORPORATION OF U.S.A. (MANUFACTURING DIVISION)

-Orangeburg Plant-

2850 Magnolia Street, Orangeburg, SC 29115, U.S.A.
TEL : 1-803-536-6200
FAX : 1-803-534-0599

-Richland Plant-

1006 Northpoint Blvd., Blythewood, SC 29016, U.S.A.
TEL : 1-803-691-4624/4633
FAX : 1-803-691-4655

JTEKT (THAILAND) Co., LTD.

172/1 Moo 12 Tambol Bangwua, Amphur Bangpakong,
Chachoengsao 24180, THAILAND
TEL : 66-38-531-988/993
FAX : 66-38-531-996

KOYO MANUFACTURING (PHILIPPINES) CORP.

Lima Technology Center, Municipality of Malvar, Batangas
Province, 4233 PHILIPPINES
TEL : 63-43-981-0088
FAX : 63-43-981-0001

KOYO JICO KOREA CO., LTD

28-12, Yulpo-Ri, Koduc-Myun, Pyung Teak-City, Kyungki-Do, KOREA
TEL : 82-31-668-6381
FAX : 82-31-668-6384

KOYO BEARING DALIAN CO., LTD.

No.II A-2 Dalian Export Processing Zone, 116600, CHINA
TEL : 86-411-8731-0972/0974
FAX : 86-411-8731-0973

WUXI KOYO BEARING CO., LTD.

Wuxi Li Yuan Economic Development Zone, Wuxi, 214072,
CHINA
TEL : 86-510-85161901
FAX : 86-510-85161143

DALIAN KOYO WAZHOU AUTOMOBILE BEARING CO., LTD.

No.96, Liaohe East Road, D.D Port, Dalian, 116620, CHINA
TEL : 86-411-8740-7272
FAX : 86-411-8740-7373

KOYO LIOHO (FOSHAN) AUTOMOTIVE PARTS CO., LTD.

No.12, Wusha Section Of Shunpan Road, Daliang Town, Shunde
Of Foshan, Guandong, Province, CHINA
(SHUNDE INDUSTRIAL PARK)
TEL : 86-757-22829589
FAX : 86-757-22829586

KOYO AUTOMOTIVE PARTS (WUXI) CO.,LTD.

B6-A New District, Wuxi, 214028, CHINA
TEL : 86-510-8533-0909
FAX : 86-510-8533-0155

KOYO BEARINGS (EUROPE) LTD.

P.O.Box 101, Elmhirst Lane, Dodworth, Barnsley,
South Yorkshire, S75 3TA, UNITED KINGDOM
TEL : 44-1226-733200
FAX : 44-1226-204029

KOYO ROMANIA S.A.

1, Tr. Magurele Street, 140003 Alexandria, ROMANIA
TEL : 40-24-731-2605
FAX : 40-24-731-5892

TECHNICAL CENTERS

JTEKT CORPORATION NORTH AMERICAN TECHNICAL CENTER

47771 Halyard Drive, Plymouth, MI 48170, U.S.A.
TEL : 1-734-454-1500
FAX : 1-734-454-4076

JTEKT (CHINA) CO., LTD. TECHNICAL CENTER

Rm.1905, Aetna Tower, 107 Zunyi Road, Shanghai, 200051,
CHINA
TEL : 86-21-6237-5280
FAX : 86-21-6237-5277

JTEKT CORPORATION EUROPEAN TECHNICAL CENTRE

Markerkant 13-02, 1314 AN Almere, THE NETHERLANDS
TEL : 31-36-5383350
FAX : 31-36-5302656

Value & Technology



This catalog has been printed on paper of recycled paper pulp using environmentally friendly soy ink.

