

Plastic Bearings



iglide[®]

Plain Bearings

DryLin[®]

Linear Systems

igubal[®]

Spherical Bearings

igus.com
Plastics for longer life.

2011

Contents

igus®: Plastics for longer life®

The following pages include application examples, design specifications, and more than 7000 iglide®, 770 igubal®, and 1840 DryLin® parts, which are available from stock. They are indexed to allow quick location.

The most important innovations of this catalog are:

- Larger selection in all product lines
- More accessories
- More solutions and practical tips
- More application examples
- New products

www.igus.com

This catalog by no means covers the entire igus® product range.

Visit our website www.igus.com to discover more products, new developments and benefit from our online range – 24 hours a day.

Legal Information

The information in this catalog, and the data in the Design section in particular, is based on our current knowledge of the products described. No legally binding assurance in respect of characteristics or suitability for a application can be derived from it. igus® is unable to assume liability of any nature for damage, loss or injury resulting from application of the products. We recommend that you always check suitability of the products for a specific intended application in a practically-oriented test. Please consult igus®. For reasons relating to ongoing technical developments, we reserve the right to implement technical modifications and improvement of the products at any time. Subject to printing errors.

The terms "igus", "ReadyChain", "ReadyCable", "Chainflex", "E-Chain", "E-Chain-System", "Energy Chain", "Energy Chain System", "E-Ketten", "E-KettenSysteme", "Flizz", "Easy Chain", "TwisterChain", "igubal", "igidur", "DryLin", "manus" and "plastics for longer life" are legally protected trademarks for igus® GmbH/Cologne in the Federal Republic of Germany and, where applicable, in some other countries.

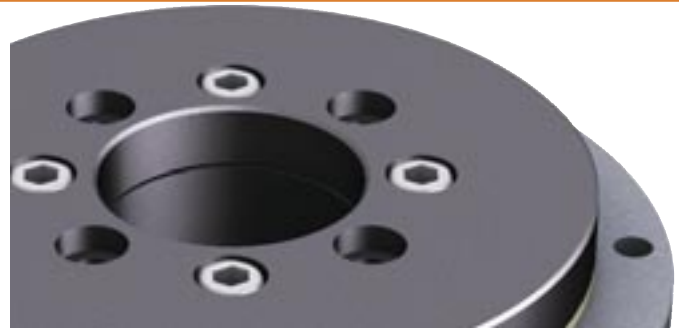

iglide®

Plastic Plain Bearings



iglide® plastic bearings are economical, dry-running, maintenance-free and best of all predictable. There are over 30 various iglide® materials to choose from depending on your applications requirements

1

xiros®

Plastic Ball Bearings



xiros® plastic ball bearings offer all of the advantages of a plastic bearing. They are lubrication-free, maintenance-free, lightweight, corrosion resistant and are predictable. They are designed for applications with high speeds and low loads.

2

Additional iglide® Products



Maintenance-free and lubrication-free plastic plain bearings in the most diverse special designs. Slewing rings, clip bearings for sheet metal, special flange bearings, and Polysorb® disc springs – the special iglide® materials always offer low costs and provide long service life.

3

DryLin®

Linear Guide Systems



Oil-free plastic linear bearings for nearly all types of applications. DryLin® linear bearings are maintenance-free, lubrication-free, and can often be used as substitutes for conventional recirculating ball bearings, profile guides and PTFE-lined bearings at considerably lower cost.

4

DryLin®

Drive Technology



Maintenance-free lead screw systems and belt-driven systems from stock, designed to reduce engineering, purchasing and assembly time.

5

igubal®

Spherical Bearings



Maintenance-free and lubrication-free spherical bearings in various designs and configurations. Whether as a rod end, pivot or flange bearing, igubal® suits all requirements and is more economical and lighter than conventional spherical bearings.

6

Table of Contents

iglide® – Standard Materials



iglide® M250

Thick and Robust

► Section 2

- Excellent vibration dampening
- Resistant to edge loading
- High impact resistance



iglide® R

Low Friction, Low Cost

► Section 3

- Low friction value
- Very low cost



iglide® J

The Fast and Slow Motion Specialist

► Section 4

- Low wear against different shaft materials
- Low coefficients of friction in dry run
- Best performance with soft shaft materials



iglide® GLW

Strong and Reasonably Priced

► Section 5

- Low cost
- Applications with static loads



iglide® G300

The All-Round Performer

► Section 6

- For above average loads
- Dirt and dust resistant
- More than 900 sizes available from stock



iglide® L280

The Marathon Runner

► Section 7

- For especially long service life
- Low coefficient of friction
- Also suitable for soft shafts



iglide® Q

Fit for High Loads

► Section 8

- Excellent wear resistance at high loads
- Recommended for extreme p x v values
- Maintenance-free dry running



iglide® P

Cost-Effective and Maintenance-Free

► Section 9

- Low moisture absorption
- Low wear rates
- Cost-effective



iglide® H370

The Underwater Specialist

► Section 10

- Excellent for underwater applications
- Wear-resistant
- Good chemical resistance



iglide® A180

Very Appetizing

► Section 11

- Complies with the regulations of the FOOD AND DRUG ADMINISTRATION
- For wet environments



iglide® A200

Very Appetizing

► Section 12

- Complies with the regulations of the FOOD AND DRUG ADMINISTRATION
- For low speeds

Table of Contents

iglide® – Standard Materials



iglide® T500

The High-Tech Problem Solver

► Section 13

- Temperature resistant from -148°F to +482°F
- Universal resistance to chemicals
- Very low moisture absorption



iglide® X6

The new Nano Material

► Section 14

- High compressive strength
- High temperature resistance up to +482°F
- PTFE-free
- Excellent chemical resistance



iglide® Z

The High Temperature Material

► Section 15

- For high temperature applications
- High thermal resistance
- For extreme loads

iglide® – Special iglide® Products



xiros® ball bearings

Polymer Ball Bearings

► Section 16

- Free from maintenance and lubrication
- High corrosion-resistance
- For temperatures up to 302°F



iglide® PRT

Slewing Ring Bearing

► Section 17

- Maintenance-free
- Low coefficients of friction
- High rigidity
- Cost-effective
- Robust

iglide® – Additional iglide® Products



iglide® Clip Bearings

► Section 18

- Secured with the double flange design
- Maintenance-free and self-lubricating
- Good wear resistance
- Smooth operation
- Material: iglide® M250



iglide® Clip2

Suitable for High Loads

► Section 19

- Low bearing clearance, very precise
- Easy installation due to angled slit
- Material: iglide® M250
- Maintenance-free and predictable service life

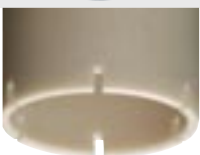

iglide® JV

Pre-tensioned, No Clearance

► Section 20

- Zero clearance, even under no load
- Material: iglide® J
- Maintenance-free
- Predictable service life



iglide® Piston Rings

► Section 21

- Free from maintenance and lubrication
- High corrosion-resistance
- For temperatures up to 482°F

Table of Contents

iglide® – Additional iglide® Products



iglide® Barstock

Design Freedom

► Section 22

- iglide® materials as round stock bar or mechanically finished special parts



iglide® Flange Bearings

► Section 23

- Maintenance-free
- Very good wear resistance
- Material: iglide® G300, J, T500 or A180



Polysorb

Polymer Disc Springs

► Section 24

- Compensation of axial clearances and manufacturing tolerances
- Vibration dampening
- Noise reduction
- Corrosion resistant
- Lightweight

DryLin® – Products



DryLin® N

Low profile guide system

► Section 26

- Low profile
- Lightweight
- Simple, low-cost design



DryLin® W

Modular linear guide system

► Section 27

- Flexible, modular linear system
- Great blend of cost and performance
- Easy to assemble



DryLin® T

Profile rail guides

► Section 28

- Maintenance and oil-free
- Low-cost alternative to ball bearing systems
- Dimensionally interchangeable with many ball bearing systems
- Adjustable clearance



DryLin® R

Linear bearings

► Section 29

- Maintenance and oil-free
- Low-cost alternative to ball bearing systems
- Dimensionally interchangeable with many ball bearing systems



DryLin® Shafting

► Section 29

- Available in Aluminum, Steel, Stainless, and Chrome-plated materials
- 6mm to 50mm diameters
- Supports and other accessories available



DryLin® Slide Tables

Belt and lead screw assemblies

► Section 30

- Pre-assembled belt and lead screw systems
- Reduces purchasing, engineering, and assembly costs
- Maintenance-free operation



DryLin® Lead Screws

► Section 31

- Oil-free
- Corrosion-resistant
- Anti-backlash available

Table of Contents

DryLin® – Products



DryLin® Stainless

Stainless steel products

► Section 32

- 304/316/440 Shafting
- Lead screw tables
- Complete 316 guide systems
- Stainless shaft supports

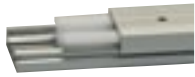

DryLin® Specialists

Outside the box ideas

► Section 33

- Hybrid sliding/rolling systems
- Telescoping systems
- Dimensionally interchangeable with many ball bearing systems
- Adjustable clearance

igubal® – Products



igubal® Rod Ends

► Section 35

- Maintenance-free
- Compensate for misalignment and edge loads
- Lightweight



igubal® Clevis Joints

► Section 36

- Vibration dampening
- Lubrication-free
- Lightweight



igubal® Pillow Block

► Section 37

- Maintenance-free
- Self-lubricating
- Compensate for misalignment and edge loads
- Lightweight

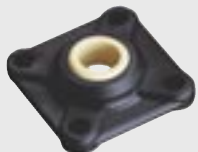

igubal® Flange

► Section 38

- Maintenance-free
- Self-lubricating
- Compensate for misalignment and edge loads
- Sturdy



igubal® Pressfit

► Section 39

- Easy to install
- Cost-effective
- Resistant to chemicals
- Lightweight and durable



igubal® Spherical Balls

► Section 40

- Different material balls are available for varying application requirements



plastics

for longer

**Plastics for longer life® –
make your machines more durable with plastics**

No lubrication, less maintenance, lower costs, longer life cycles, always available from stock – these key principles apply to all igus® products, systems and services.

Tried and tested in terms of durability, friction properties and stability, igus® plastics are the technological core of the igus® range. This catalog lists more than 9,600 plastic bearing products available from stock from the smallest batch size upward.

We are looking forward to your phone call or e-mail.

er life

igus® inc.
P.O. Box 14349
East Providence, RI 02914
401-438-2200
888-803-1895
sales@igus.com
www.igus.com

Orders can be placed until 8:00 Eastern standard time.
Phone: 888-803-1895

No minimum order quantity, no surcharges.
9,600 plastic bearings from stock.

No lubrication. No maintenance. No downtime.

No lubrication. No maintenance. No downtime.

Call for free samples and technical support or visit www.igus.com



igus® headquarters in Cologne, Germany –
research, development and production
from a single location.

igus® is certified to ISO 9001:2008

Longer life cycles, lower costs

Innovations with high-performance plastics

igus® plastic plain bearings® constitute the step from a simple plastic bearing to a tested, predictable and available machine component.

Our research is based on specific bearing properties – especially life cycle – achieved by continuous advancements in materials.

Predictable life cycle – no lubrication necessary

Lubrication-free operation is something every designer strives for.

igus® plastic plain bearings make this dream a reality. Decades of research and testing now permit precise calculations of a plastic plain bearing's life cycle.

Fit and forget – matching solutions from stock

- Innovative, quickly assembled and economical products
- Delivery from stock – lower inventory costs
- Large product selection – find the right solution for your application
- Time-saving tools on the Internet
- We deliver customized, ready-to-fit units
- Quick reaction customer service with many local representatives in United States, Canada, Mexico and worldwide.

igus® maintenance-free plastic plain bearings help improve your products and reduce costs at the same time.

Many sample applications can be found at:
www.igus.com/bearings-applications





Corrosion-free with igus®

Low weight, corrosion resistance as well as zero maintenance and lubrication achieve solutions for nearly all types of applications.
Fit and forget!

Resistant to dirt with igus®

Zero-maintenance and high dirt resistance are not the only advantages of DryLin®.
Longer life cycles – lower costs!



No maintenance with igus®

Various iglide® materials for a wide variety of operating conditions. Large program of dimensions compatible with nearly all environments.
Predictable life cycle!



No lubrication with igus®

The lubrication-free design of iglide® also permits its use in the food and pharmaceutical industries.
Don't wait any longer!



iglide[®] plain bearings

Excellent plastics, improved through precise additions of reinforcements and solid lubricants, tested thousands of times, and proven millions of times – that is iglide[®].

Every year, igus[®] engineers develop more than 100 new plastic compounds and conduct more than 5,000 tests on maintenance-free plain bearings. Over the years, this has made it possible to establish a large database of plastics' tribological properties.

In addition to their general properties, every iglide[®] bearing material possesses a number of special features making it suitable for particular applications and requirements.



Part number:

iglide[®] J
Plain bearings

Maximum static
surface pressure (68°F)

5,075 psi

Application
temperature

-58 °F / +194 °F

Color

yellow

Coefficient of dynamic
sliding friction against
steel (μ)

0.06-0.18

Practical example

KHS AG Abfüllanlagen (bottling systems)

igus® bearings and linear sliding films made of iglide® material, which meets all demands of aseptic filling, are used here.

Low adhesion and friction factors against different kinds of stainless steel, negligible moisture absorption, very good stability against PES-cleaners, lubricant-free, all of that means no contamination of products of the aseptic atmosphere.

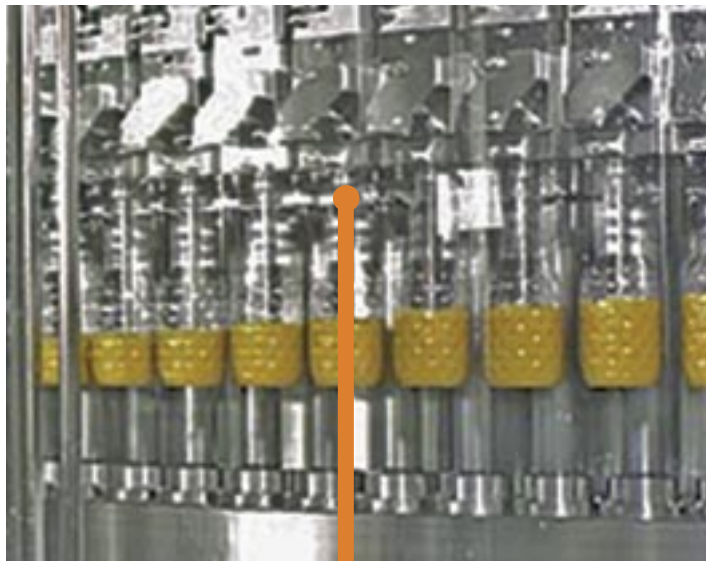

Lifetime calculation online:
www.igus.com

Exciting applications can be viewed online at:
www.igus.com/bearings-applications

Application examples: iglide®

Exciting applications can be viewed online ► www.igus.com/bearings-applications



Sleeve bearing



Thrust washer



Clip1 bearing



Plastic ball bearing



Flange bearing



PRT slewing ring



Clip 2 bearing



Custom part

Roller coaster

Using iglide® Z bearings eliminated maintenance by 95% and reduced costs by 54%.





Spreaders

Using a special bearing design on this centrifugal arm significantly reduced manufacturing costs. iglide® is also maintenance-free and delivers high wear resistance.



Boat lifts

Unlike metal or bronze bearings, iglide® plastic bearings do not corrode in this underwater application. The self-lubricating bearings handle loads from 4,500 up to 66,000 pounds and also do not contaminate the water with grease, making it an environmentally-friendly solution.



Welding machine

PRT in this automatic welding machine enables rotation in the horizontal plane of the chuck



Tool changer machines

iglide® D offered an enormous cost savings when compared to metallic rolled bearings. iglide® D also has a low coefficient of friction and high wear resistance.



Farming equipment

A manufacturer of agricultural machinery replaced bronze bearings with iglide® J plastic bearings to eliminate corrosion and increase lifespan on its potato planter. Service life increased by 600% and iglide® costs the company 70-80% less than bronze.



Tubular bag machines

iglide® Z is used in the arms of this packaging machine. The bearings withstand operating temperatures of more than 320 degrees Fahrenheit and are wear-resistant.

DryLin® linear plain bearings and Lead screw tables

DryLin® linear plain bearings are an ideal alternative to traditional re-circulating ball bearing systems. These sliding plain bearings are made of high-performance polymers from igus® iglide® series. DryLin® linear bearings can be used if dirt, dust or moisture is present, for short stroke applications, or if a lubrication-free solution is needed.

DryLin® linear slide tables are also designed for dry running. As a result, dust and dirt will not cling to the bearing surfaces. DryLin® linear bearings also have no minimum stroke-length restrictions, unlike re-circulating ball bearings. They deliver quiet operation and are corrosion-resistant.

igus® also offers flat, compact lead screw linear tables for variable formats and handling tasks. The linear table is extremely rigid due to the hard-anodized aluminum shaft and is also made of igus® high-performance iglide® polymers.



Part number:

HTS-12-AWM

Maximum static surface pressure

630 lbf

Operating temperature

-40°F/+194°F

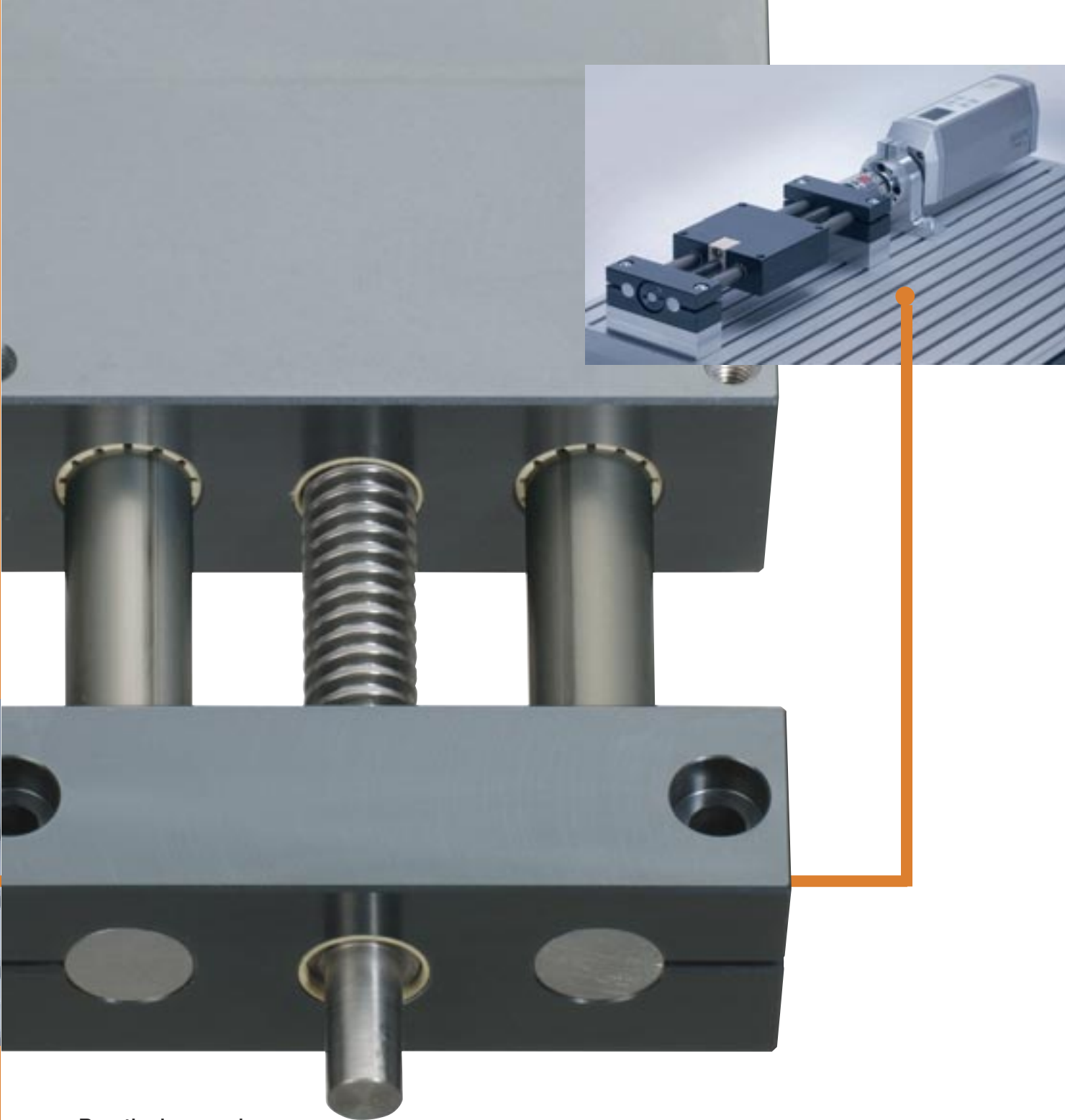

Practical example

Electrical Servo Drives

For a wide variety of formats in printing, paper, packaging, transmission and wood processing systems, Festo demonstrates the use of the HTS DryLin® Lead screw linear table in conjunction with its electrical servo drive.



reddot design award
winner 2006



Lifetime calculation online:
www.igus.com

Exciting applications can be viewed online at:
www.igus.com/bearings-applications

Application examples: DryLin®

Exciting applications can be viewed online ► www.igus.com/bearings-applications



DryLin® N



DryLin® W

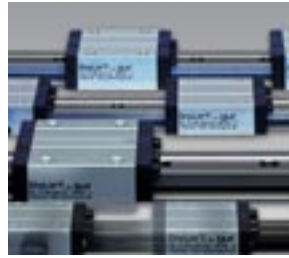

DryLin® T



DryLin® R

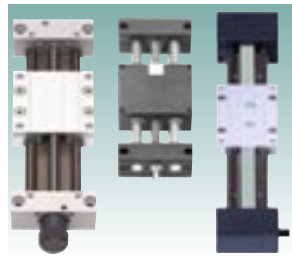

DryLin® slide tables

Packaging technology: Label feeding system

DryLin® T linear guides are dimensionally interchangeable with traditional re-circulating ball guides, but without the high costs. A further advantage is the availability of a manual clamping mechanism.

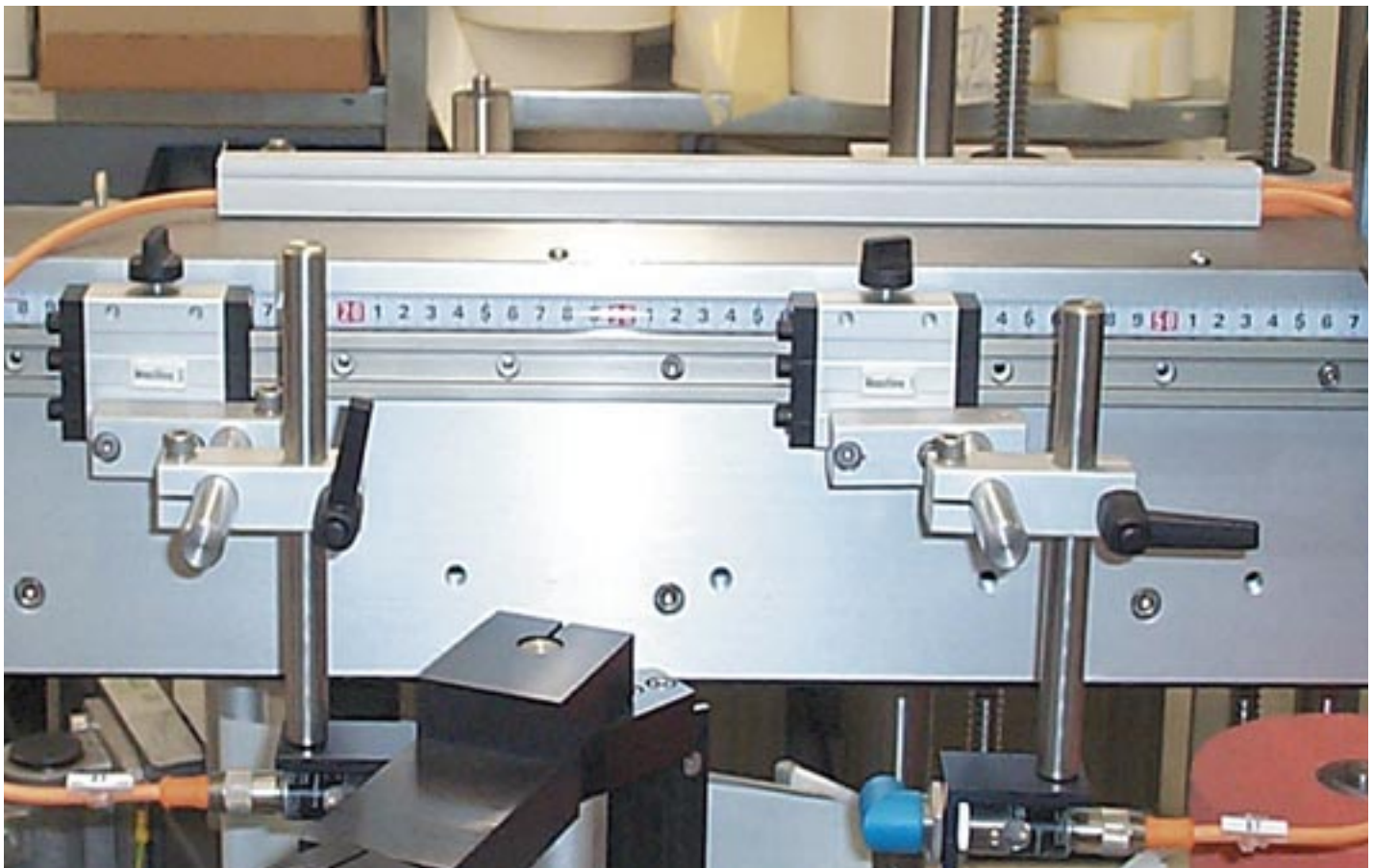



Bottle sealing machines

This machine seals champagne bottles with corks, aluminum caps and wire braid. DryLin® R linear bearings are lubrication-free, which is important in the food industry. DryLin® R is also impervious to the frequent cleaning and chemicals seen by the machine.



Form/fill/seal machines

DryLin® linear bearings are used to guide the tools of this form, fill and seal machine. The bearings are exposed to temperatures reaching 248 degrees Fahrenheit and are self-lubricating. The bearings are also resistant to the machine's corrosive cleaning agents, which minimizes downtime.



Machine tool technology: Door adjustment

DryLin® R linear bearings are used to guide the doors of this machine. The bearings are a huge cost savings and because they require no lubrication, flying chips do not cause downtime by getting stuck in the machine.



Packaging equipment

These packaging machines use DryLin® R sleeve bearings to reduce installation time. They are resistant to dust, dirt and water. DryLin® R is also maintenance-free and can reduce replacement part costs up to 90%.



Medical devices

DryLin® linear guide systems and DryLin® R linear bearings are used on this medical machine, which performs non-invasive treatment of chronic heel pain. With DryLin® linear bearings and guides, the company eliminated costly maintenance and the need for messy lubricants.



Aluminum window manufacturing

This machine manufactures aluminum window frames. A DryLin® HTS linear slide table is used to position the machine's milling heads. DryLin® HTS is lubrication-free, which prevents aluminum dust and chips from building up and causing downtime.

igubal® spherical bearings

igubal® spherical bearings are self-aligning components made entirely of high-performance plastics.

The igubal® series provides designers with a complete system of self-aligning bearings: Rod ends, clevis joints, flange bearings, pivot bearings and pillow blocks. Self-adjusting bearings are easy to fit, adaptable to wide angular ranges and have been used to replace special housings in many cases.

igubal® offers all the advantages of high-performance plastics, including dry-running capability combined with very good vibration dampening.

igubal® spherical bearings are insensitive to dirt, liquids, chemicals and fully corrosion-proof.

Bearings from the igubal® range are very light, compact and economical on two fronts:

- Low purchase price
- Low maintenance and installation costs



Part number:

KBRM-08

Maximum static tensile load

470 lbf

Maximum transverse load

157 lbf

Minimum screw-in depth

.43 in.

Maximum tightening torque for internal thread

88 lbf · inch

Maximum tightening torque for spherical ball

106 lbf · inch



Practical example

The reclining wheel's curve inclination is realized by means of rod ends in the journal link.

The high top speed and rapid acceleration are partly due to the rod ends' low weight. The bearing points do not require any elaborate sealing measures.

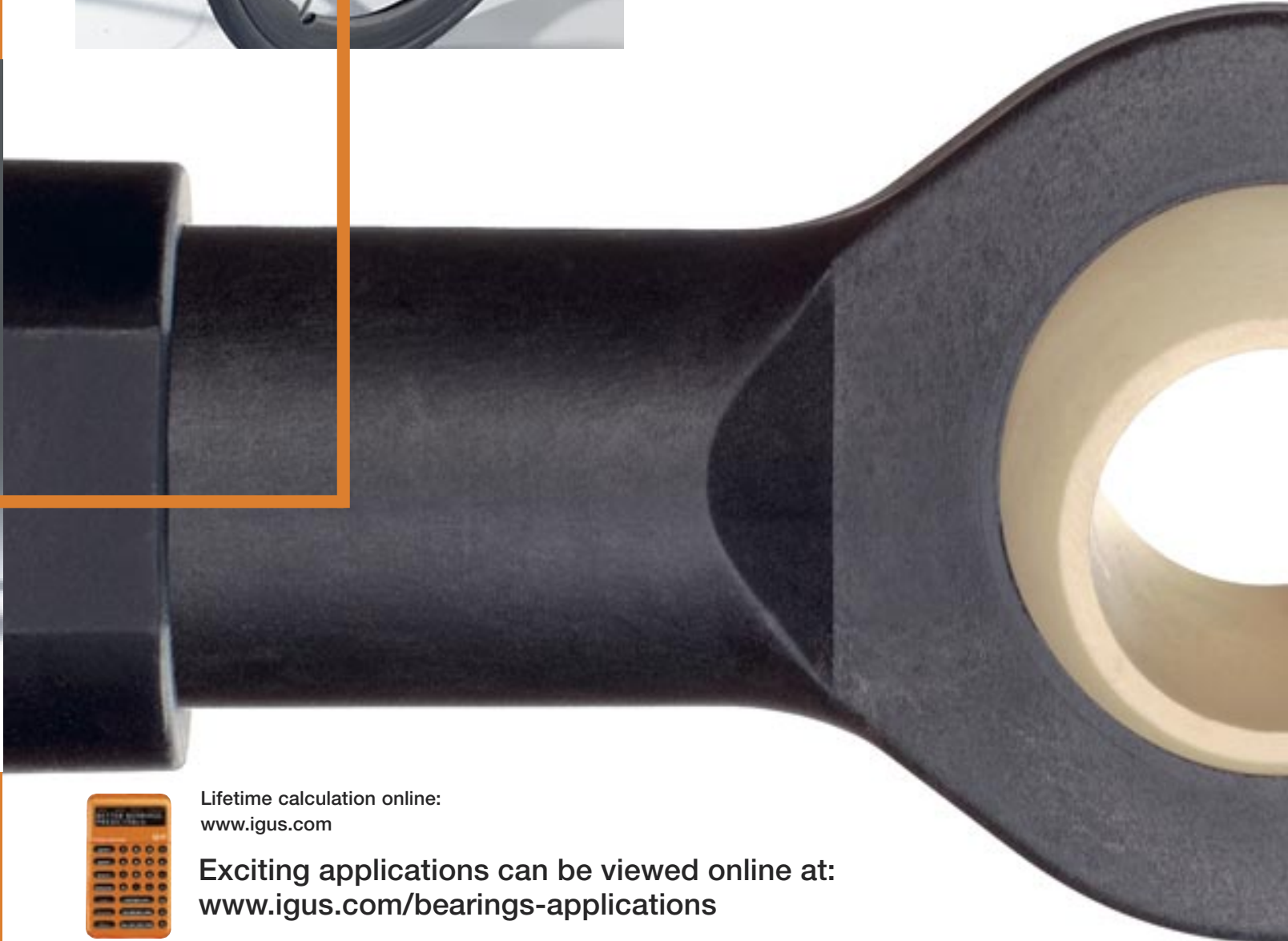

Lifetime calculation online:
www.igus.com

Exciting applications can be viewed online at:
www.igus.com/bearings-applications

Application examples: igubal®

Exciting applications can be viewed online ► www.igus.com/bearings-applications



igubal® rod ends



igubal® clevis joints



igubal® pillow blocks



igubal® flange



igubal® spherical

Curtain wall louvers for stadiums

igubal® spherical bearings are used on the main assembly of these wall louvers. The bearings enable the slats, which are part of the wall louver, to swivel so airflow can be regulated inside the stadium. igubal® is maintenance-free and corrosion-resistant.





Research telescopes

igubal® spherical bearings are used to facilitate the movement of mirrors on this telescope. Smooth motion is achieved and magnetic interference is completely eliminated thanks to igubal® plastic bearings.



Basketball shooter

Students from Iowa State University used igubal® spherical bearings on a basketball shooter for children with Cerebral Palsy. The shooter uses igubal® flange and pillow blocks to enable the shooting mechanism to be pulled back with radial loads of 250 pounds.



Packaging machines

igubal® spherical bearings perform a high number of cycles without maintenance or lubrication. igubal® is also dirt- and dust-resistant and will not contaminate food handled by the machines.



Recreational vehicle steps

igubal® rod ends are used in the steps of this RV. They are maintenance-free and vibration-dampening.



Textile machinery

Self-aligning igubal® clevis joints are used to support the thread guide unit on this textile machine. Shock loads are no longer an issue and vibration is drastically reduced when compared to metal bearings.



Baking machinery

igubal® spherical bearings do not contaminate the chocolate processed by this machine because they are lubrication-free. igubal® is also corrosion-resistant and can be used in wash-down applications or anywhere moisture is present.

Quality from the igus[®] laboratory: Tested thousands of times, proven millions of times.

igus[®] has more than 40 years of experience in providing customers with plastic bearing solutions. Every year, igus[®] engineers develop more than 100 new plastic compounds and conduct more than 5,000 tests on its maintenance-free plastic plain bearings. Over the years, this has made it possible to establish a large database of plastics' tribological properties. In addition to their general properties, every iglide[®] bearing material possesses special features that make it suitable for particular applications and requirements. igus[®] bearings constitute the step from a simple plastic bearing to a tested, predictable and available machine component.

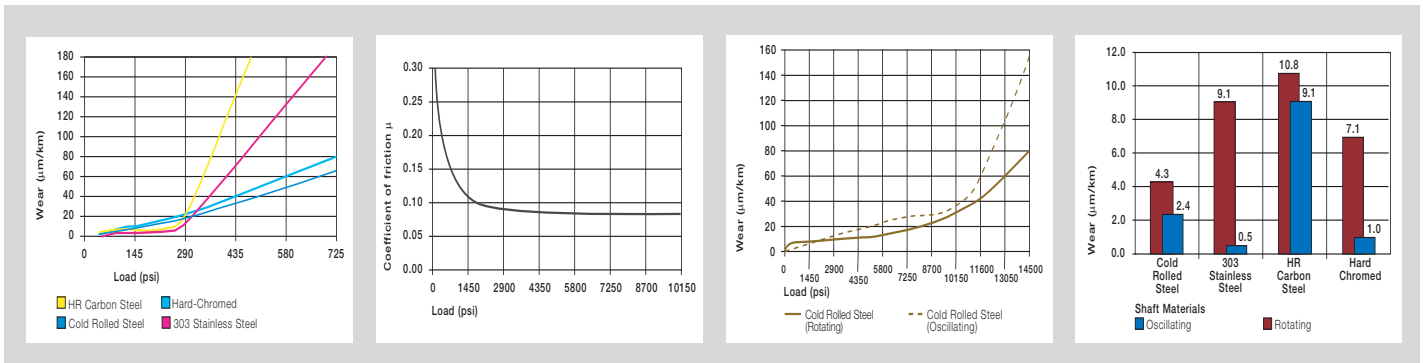

The results of more than 5,000 tests are added to our database annually.

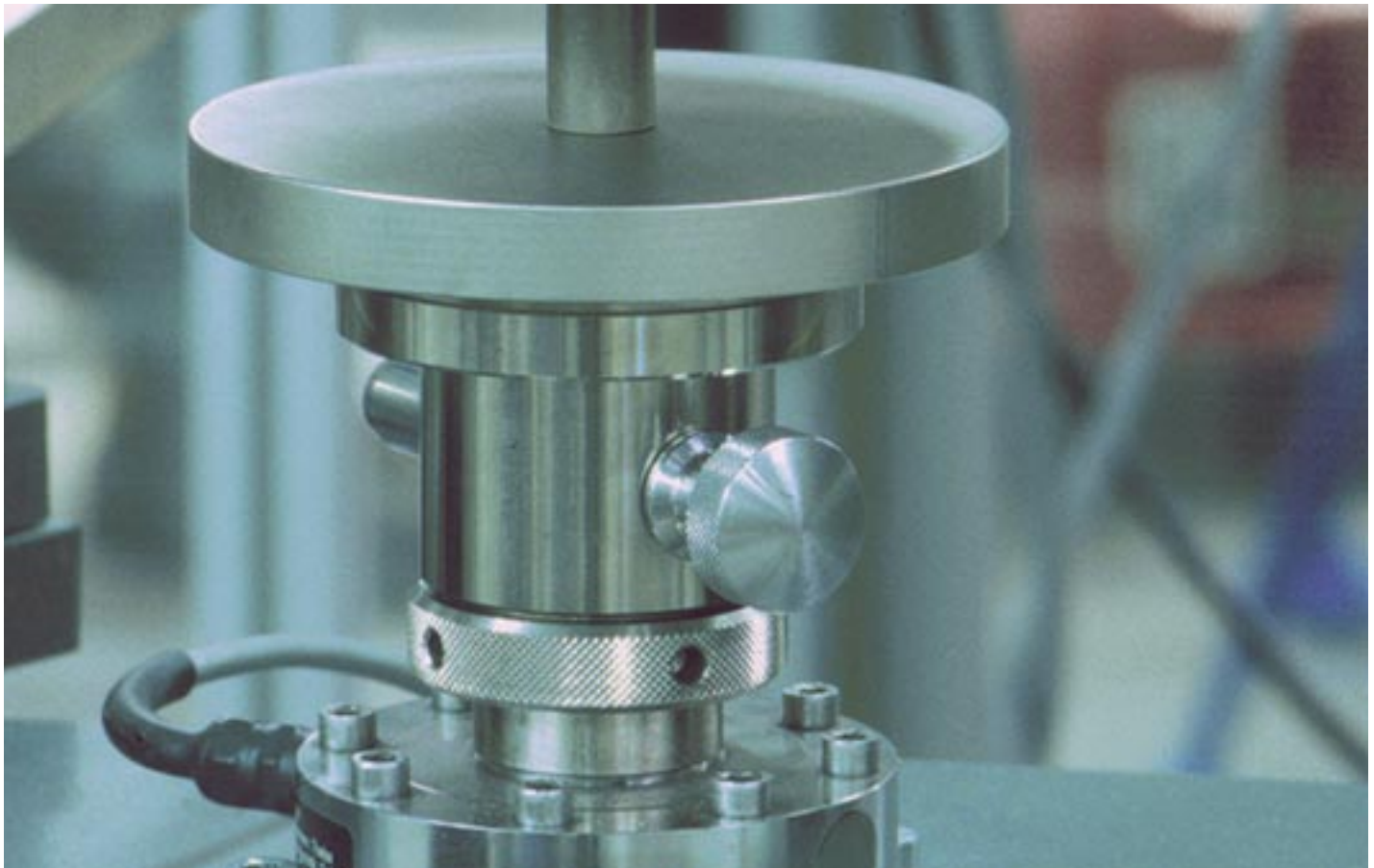

Product testing in action

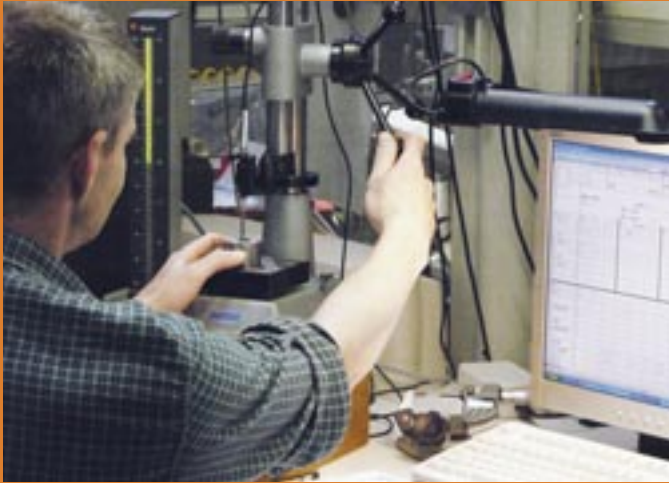

igus® is committed to quality assurance.



Above is a test to determine the maximum running speed of an igubal® pillow block bearing.

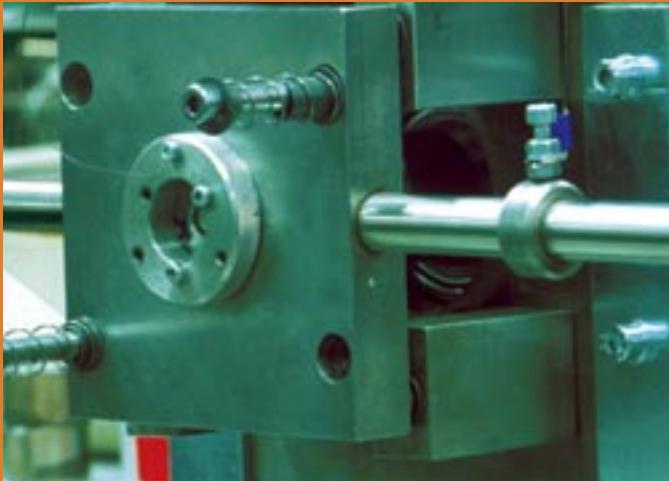

This is an example of friction and abrasion measurement in a rotation test.



Pictured is a bench test for loads up to 21,755 psi and temperatures up to 482 degrees Fahrenheit.

The Application Corner

In addition to all the applications you have read about in this brochure, more examples and an extensive video library can be found in igus®' Application Corner at www.igus.com/bearings-applications.

igus® Inc. is proudly certified by the National Quality Assurance (NQA) against the provisions of ISO 9001:2008. All products are tested and available from a single source.

Examples of test certificates and quality seals for igus® products:

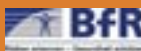

... more by request.

Lubrication-free with igus® good for the environment and the wallet

Plastic bearings offer environmental benefits

Tribologically optimized iglide® plastic plain bearings from igus® require neither oil nor grease. They are lubrication-free, so no contaminants escape into the environment.

One billion gallons of industrial lubricants are consumed annually in the United States, of which an estimated 40 percent is released into the environment. This is becoming increasingly environmentally unacceptable and there is a growing need to find 'green' substitutes.

Due to continually advancing bearing technology, igus® is able to supply metal plain and rolling bearing alternatives more in line with environmental considerations for an increasing number of applications.

The amount of oil used in plastics manufacturing is also very positive in comparison with aluminum and steel production. Whereas the energy from 16 quarts of oil is necessary to produce 1 quart of aluminum, and 1 quart of steel requires 12 quarts of oil, to produce 1 quart of plastic only needs an average of 1.9 quarts of oil. The production of plastics only makes up 4 percent of annual oil requirements globally.

Lubricant-free and light

The solid lubricants contained within iglide® polymer plain bearings are not the only ecologically valuable benefit. The lightweight bearings can also help to reduce fuel consumption and carbon dioxide output in vehicles or aircrafts, for example. The reduced weight leads to lower masses and subsequently lower energy consumption.

The high chemical resistance of plastic bearings is another positive ecological aspect because metals are often coated to achieve this effect. This takes place in environmentally unfriendly, high-energy zinc galvanizing baths.



In contrast to metallic plain and rolling bearings, iglide® plastic plain bearings from igus® require no oil or grease



A study has found that nearly half of all machine lubricants used in Germany seep into soil, water or evaporate into the atmosphere. iglide® bearings require no lubrication, which would aid in solving this problem.

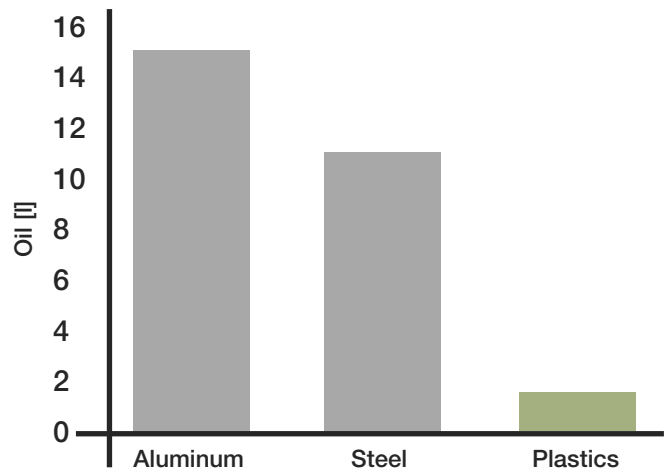

The energy required to produce one volume liter of material (converted to liters of oil). Source: Clausthal University of Technology



Lifetime calculation online:
www.igus.com

Exciting applications can be viewed online at:
www.igus.com/bearings-applications

Choosing the perfect iglide® bearing for your application.

Plastics for longer life

High performance iglide® bearings are a viable, cost-effective alternative to metal, ball bearings, and bronze. They are fast becoming a standard choice for design engineers. Engineers are realizing that advanced synthetic compounds provide more design opportunities than traditional materials. Based on customer applications and requirements the igus® research and development team is continually developing new materials to meet these challenges. All iglide® maintenance-free bearings deliver superior performance, even in severe environments.

Very few basic materials can be modified and adapted, as well as thermoplastics. Thermoplastics can be produced with lubricants, they can be reinforced mechanically by the addition of technical fibers, or they can be varied by additional filling materials, especially in regard to friction and wear behavior.

The solid lubricants used in iglide® bearings are, as microscopic particles, embedded in millions of tiny chambers of the mostly fiber-reinforced material. From these chambers, the plain bearings release tiny amounts of solid lubricants during movement. The solid lubricants help to lower the coefficient of friction of the iglide® bearing. Since they are embedded in the tiny chambers, they cannot be pressed out. They are always there as soon as the bearing or the shaft is set in motion. Because iglide bearings are self-lubricating, an external lubricant is not necessary.

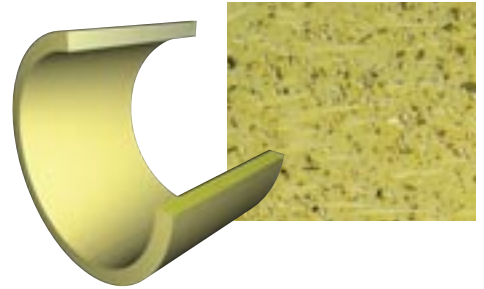

Predictable

Each year, igus® engineers develop more than one hundred new plastic compounds and test maintenance-free plain bearings in more than 5,000 experiments. Through many years of research and testing, igus has been able to make its bearings predictable. In recent years igus has compiled an extensive database of the tribological properties of plastics. This database makes it possible for us to better assess the overwhelming number of applications in advance, to calculate the expected service life, and provide our customers with confidence during use.

What design engineers need more than ever is predictability, reliability and speed. With the help of igus' online Expert System, in just a few minutes engineers can reliably determine which bearing best suits their application and receive a service life analysis based on empirical test results.

From start to finish, igus® is here for you















igus design technicians are ready to assist you with every step from design to production. Our highly trained experts are available by phone or e-mail and free on-site demonstrations and evaluations are always encouraged. Please visit our Web site at www.igus.com for detailed technical information, 3D CAD drawings ready for download and to use our Predictability Expert Systems.

Send us a request for free test samples, then place your order from over 9,600 standard dimensions or special parts.















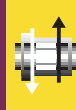



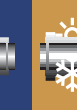
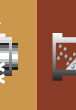



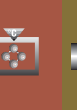

Selection According to Industry

iglide® plastic plain bearings are designed to meet a variety of application parameters so they can be used in many different industries and applications. Use the chart below as a guideline for getting started. To speak with an igus® sales engineer, call 1-888-803-1895



















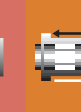
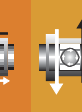





														
iglide®	M250	R	J	GLW	G300	L280	Q	P	H370	A180	A200	T500	X6	Z
Agriculture	●	●	●	●	●			●						
Bicycle			●		●	●		●						
Automation					●	●	●	●	●					
Automotive	●			●	●									
Construction					●			●				●	●	●
Cylinders/ Pneumatic			●			●			●	●				
Fitness Equipment	●	●	●	●		●								
Food Mfg Preparation										●	●			
Home Appliances	●	●	●	●						●	●	●	●	●
Lifting Equipment					●	●	●	●						
Marine			●		●			●	●			●		
Medical	●	●	●	●	●					●	●			
Office Furniture	●	●	●	●										
Packaging	●	●	●	●						●	●			
Printing/Copy Machines				●	●	●	●							
Pumps/Valves												●	●	●
Recreational vehicles		●	●	●				●					●	

Selection According to Main Criteria

Standard materials available from stock

														
iglide®	M250	R	J	GLW	G300	L280	Q	P	H370	A180	A200	T500	X6	Z
 long life dry running	●	●	●		●	●	●	●		●		●	●	●
 for high loads					●		●					●		●
 for high temperatures									●			●	●	●
 low friction/high speed		●	●			●	●		●	●			●	●
 dirt resistant	●			●	●	●		●			●			
 chemical resistant									●			●	●	●
 low water absorption		●	●					●	●			●	●	●
 food suitable										●	●			
 vibrations dampening	●										●			
 edge pressure	●	●	●			●				●	●			●
 for under water use									●			●		
 economic	●	●	●	●	●	●		●		●				

Special Bearing Materials - Call for lead time

														
iglide®	A290	A350	A500	D	F	H	H1	H2	H4	J200	J3	L250	UW	UW500
 long life dry running		●					●		●	●	●	●		
 for high loads	●		●		●									
 for high temperatures		●	●			●	●	●	●					●
 low friction/ high speed		●		●			●		●	●	●	●		
 dirt resistant										●				
 chemical resistant			●			●	●	●	●					●
 low water absorption		●	●			●	●	●	●		●		●	●
 food suitable	●	●	●											
 vibrations dampening														
 edge pressure		●	●	●			●		●	●	●	●		
 for under water use		●	●			●	●	●	●				●	●
 economic	●			●					●	●	●		●	

Selection According To Four Main Criteria

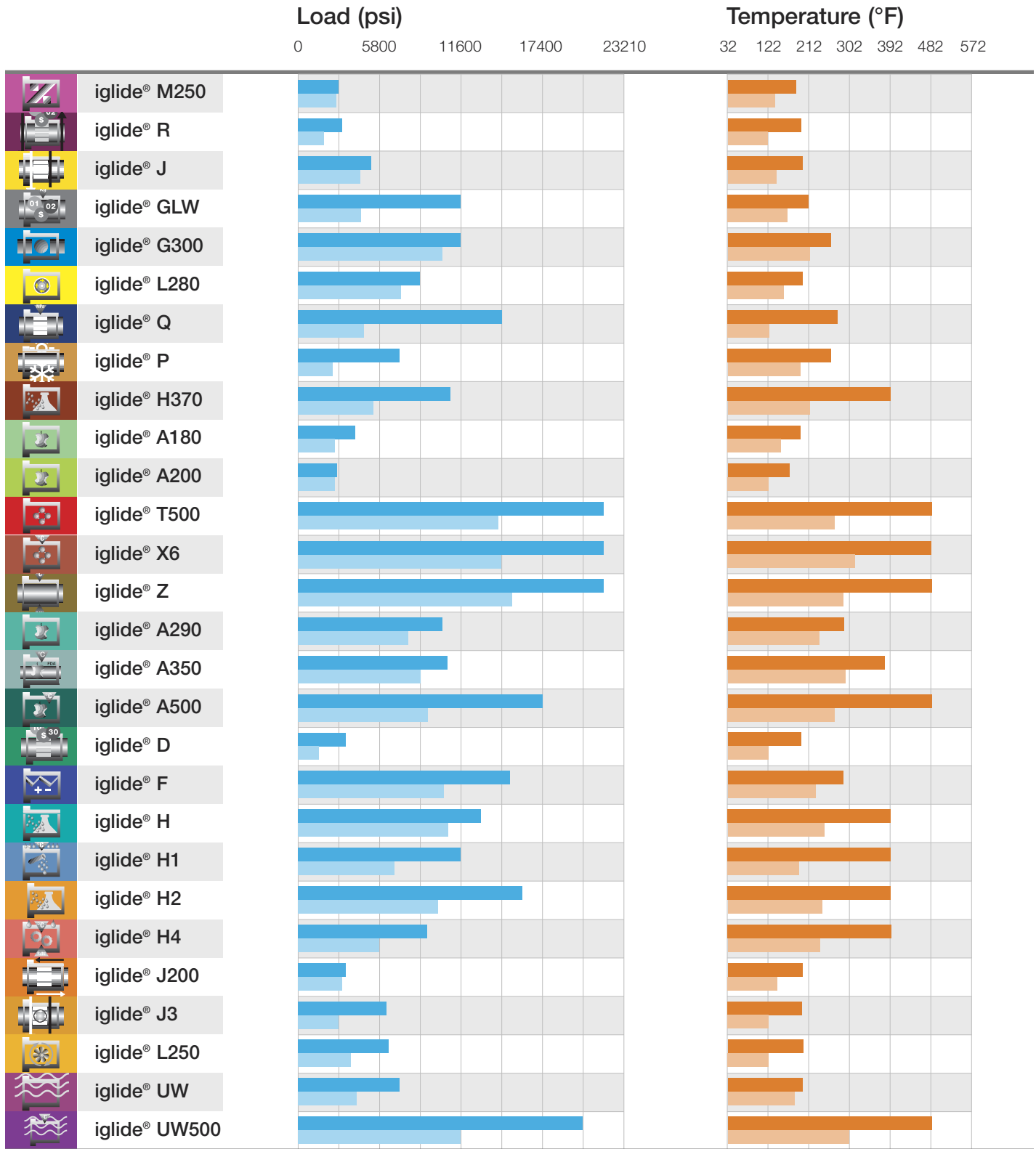

Maximum permissible radial load of iglide® bearings

- at 68°F
- at 248°F

Important temperature limits of iglide® bearings

- = Maximum permissible application temperature, continuous
- = Temperature where bearings need to be secured against radial or axial movement in the housing

Selection According To Four Main Criteria

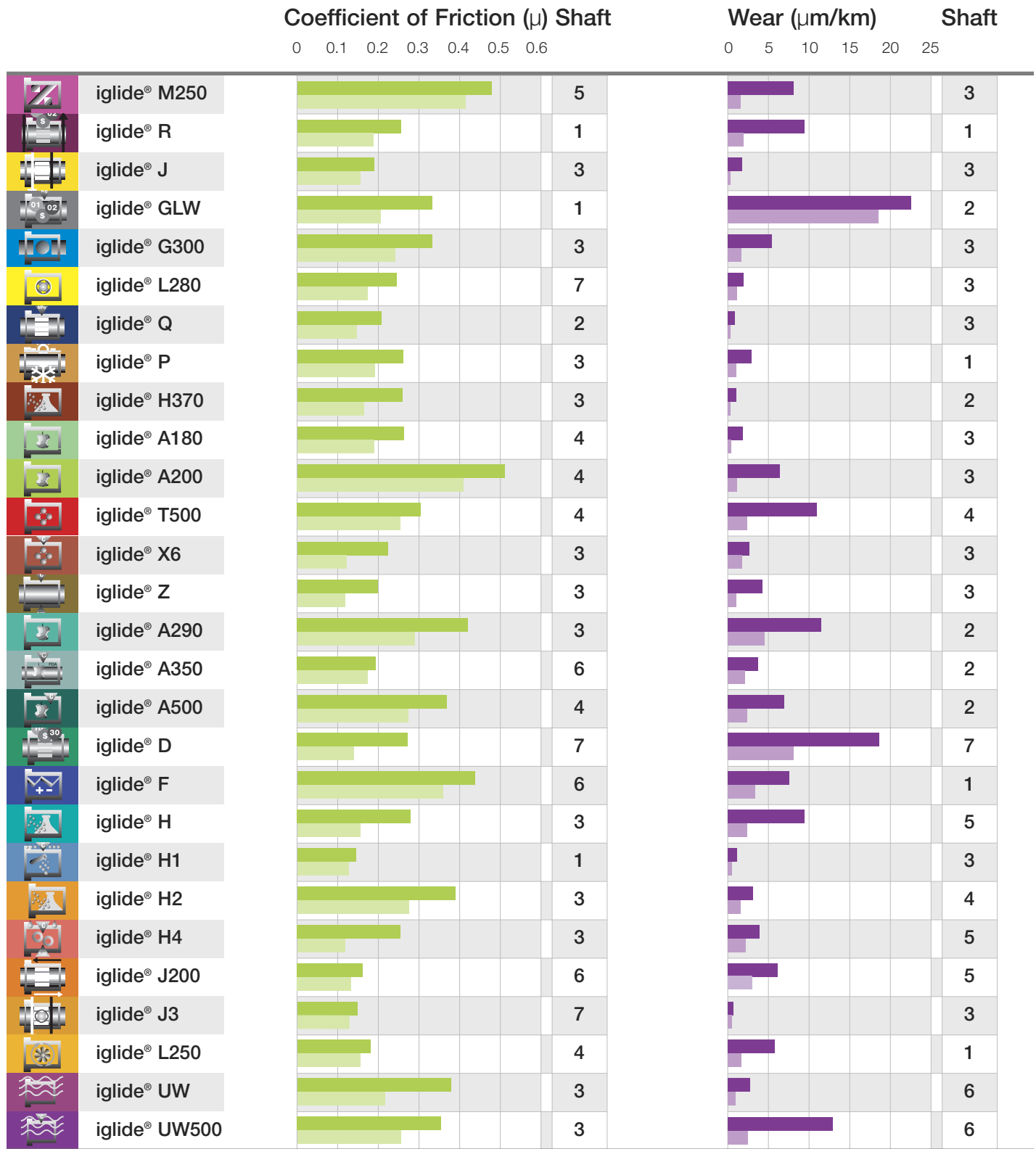

Coefficients of friction of iglide® bearings sliding against steel, p = 174 psi, v = 59.06 fpm

- Coefficient of friction of best combination
- Average coefficient of all the seven sliding combinations tested

Wear of iglide® bearings sliding against steel, p = 145 psi

- Wear of best combination
- Average wear of all the seven sliding combinations tested

Shaft material:

- 1 = Case hardened
- 5 = Machining steel
- 2 = Hard chromed
- 6 = 303 Stainless
- 3 = Hard anodized aluminum
- 7 = 440B Stainless
- 4 = Free-cutting Steel

Selection Guide 1

Standard Materials

General Properties

	iglide® M250 standard from stock	iglide® R standard from stock	iglide® J standard from stock	iglide® GLW standard from stock	iglide® G300 standard from stock
Density g/cm ³	1.14	1.39	1.49	1.36	1.45
Color	Charcoal	Red	Yellow	Black	Dark gray
Max. moisture absorption at 73°F / 50% r.h. % weight	1.4	0.2	0.3	1.3	0.7
Max. moisture absorption % weight	7.6	1.1	1.3	5.5	4.0
Coefficient of sliding friction, dynamic against steel μ	0.10 - 0.30	0.08 - 0.26	0.06 - 0.18	0.10 - 0.24	0.08 - 0.15
p x v-value, max. (dry) psi x fpm	3,400	8,700	9,700	8,600	12,000

Mechanical Properties

Modulus of elasticity psi	391,600	290,000	348,000	1,116,500	1,131,000
Tensile strength at 68°F psi	16,240	10,150	10,585	34,075	30,450
Compressive strength psi	7,540	9,860	8,700	10,730	11,310
Max. permissible static surface pressure (68°F) psi	2901	3,335	5,075	11,600	11,600
Shore D-hardness	79	77	74	78	81

Physical and Thermal Properties

Max. long-term application temperature °F	176	194	194	212	266
Max. short-term application temperature °F	338	230	248	320	428
Min. application temperature °F	- 40	- 58	- 58	- 40	- 40
Thermal conductivity (W/m x K)	0.24	0.25	0.25	0.24	0.24
Coefficient of thermal expansion (at 23°C) (K ⁻¹ x 10 ⁻⁶)	10	11	10	17	9

Electrical Properties

Specific volume resistance Ω cm	> 10 ¹³	> 10 ¹²	> 10 ¹³	> 10 ¹¹	> 10 ¹³
Surface resistance Ω	> 10 ¹¹	> 10 ¹²	> 10 ¹²	> 10 ¹¹	> 10 ¹¹

	iglide® L280 standard from stock	iglide® Q standard from stock	iglide® P standard from stock	iglide® H370 standard from stock	iglide® A180 standard from stock	iglide® A200 standard from stock	iglide® T500 standard from stock	iglide® X6 standard from stock	iglide® Z standard from stock
	1.24	1.40	1.58	1.60	1.46	1.14	1.44	1.53	1.40
	Yellow	Black	Black	Gray	White	White	Black	Blue Gray	Brown
	1.3	0.9	< 0.2	< 0.1	0.2	1.5	0.1	0.1	0.3
	6.5	4.9	0.4	< 0.1	1.3	7.6	0.5	0.5	1.1
	0.08 - 0.23	0.05 - 0.15	0.06 - 0.21	0.07 - 0.17	0.05 - 0.23	0.10 - 0.40	0.09 - 0.27	0.09 - 0.25	0.06 - 0.14
	6,600	16,000	11,000	21,000	8,750	2,900	37,700	38,350	24,000
	507,500	652,500	768,500	1,609,919	333,600	362,500	1,174,500	2,320,600	348,000
	18,125	17,400	17,400	19,575	12,760	16,820	24,650	42,060	13,775
	8,845	12,905	9,570	11,455	11,312	7,830	14,500	27,557	9,425
	8,700	14,500	7,250	10,875	2,900	2,610	21,750	21,755	21,750
	77	83	75	82	76	81	85	86	81
	194	275	266	392	194	146	482	482	482
	356	311	392	464	230	338	599	599	590
	- 40	- 40	- 40	- 40	- 58	- 40	- 148	- 148	- 148
	0.24	0.23	0.25	0.5	0.25	0.24	0.6	0.55	0.62
	9	5	4	5	11	10	5	1	4
	> 10 ¹³	< 10 ¹⁵	> 10 ¹³	< 10 ⁵	> 10 ¹²	> 10 ¹³	< 10 ⁵	< 10 ⁵	> 10 ¹¹
	> 10 ¹²	< 10 ¹²	> 10 ¹²	< 10 ⁵	> 10 ¹¹	> 10 ¹²	< 10 ³	< 10 ⁵	> 10 ¹¹
	SECTION 7	SECTION 8	SECTION 9	SECTION 10	SECTION 11	SECTION 12	SECTION 13	SECTION 14	SECTION 15

Selection Guide 2

Special Materials

The following list of materials is available upon request Please call your iglide® Sales technician for more information 1-888-803-1895

General Properties

	iglide® A290	iglide® A350	iglide® A500	iglide® D	iglide® F
Density g/cm ³	1.41	1.28	1.28	1.40	1.25
Color	White	Light Blue	Brown	Green	Black
Max. moisture absorption at 73°F / 50% r.h. % weight	1.7	0.3	0.3	0.3	1.8
Max. moisture absorption % weight	7.3	0.5	0.5	1.1	8.4
Coefficient of sliding friction, dynamic against steel μ	0.13 - 0.40	0.26 - 0.41	0.26 - 0.41	0.08 - 0.26	0.10 - 0.39
p x v-value, max. (dry) psi x fpm	6,500	8,000	8,000	7,700	9,700

Mechanical Properties

Modulus of elasticity psi	1,276,300	522,100	522,100	290,075	1,682,400
Tensile strength at 68°F psi	36,200	20,300	20,300	10,400	37,700
Compressive strength psi	13,100	11,310	n.d.	10,150	14,200
Max. permissible static surface pressure (68°F) psi	10,100	17,400	17,400	3,330	15,200
Shore D-hardness	88	83	83	78	84

Physical and Thermal Properties

Max. long-term application temperature °F	284	482	482	194	284
Max. short-term application temperature °F	356	572	572	230	356
Min. application temperature °F	-40	- 148	- 148	- 58	- 40
Thermal conductivity (W/m x K)	0.24	0.24	0.24	0.25	0.65
Coefficient of thermal expansion (at 23°C) (K ⁻¹ x 10 ⁻⁶)	7	9	9	11	12

Electrical Properties

Specific volume resistance Ω cm	> 10 ¹¹	> 10 ¹⁴	> 10 ¹⁴	> 10 ¹⁴	< 10 ³
Surface resistance Ω	> 10 ¹¹	> 10 ¹³	> 10 ¹³	> 10 ¹⁴	< 10 ²

	iglide® H	iglide® H1	iglide® H2	iglide® H4	iglide® J200	iglide® J3	iglide® L250	iglide® UW	iglide® UW500
	1.64	1.53	1.69	1.79	1.72	1.50	1.50	1.52	1.49
	Gray	Cream	Brown	Brown	Dark Gray	Yellow	Beige	Black	Black
	< 0.1	0.1	< 0.1	0.1	0.2	0.3	0.7	0.2	0.1
	0.3	0.3	0.2	0.2	0.7	1.3	3.9	0.8	0.5
	0.07 - 0.20	0.06 - 0.20	0.07 - 0.30	0.08 - 0.25	0.11 - 0.17	0.06 - 0.20	0.08 - 0.19	0.22 - 0.5	0.20 - 0.36
	39,000	22,800	16,500	9,400	8,600	14,000	11,500	8,600	10,000
	1,812,900	406,000	1,494,000	1,087,700	406,000	391,600	282,800	1,392,362	2,320,500
	25,300	7,900	30,450	17,400	8,412	10,150	9,700	13,000	37,700
	11,700	11,300	15,805	7,250	6,230	8,700	6,810	10,150.	18,850
	13,053	11,600	15,950	9,400	3,330	6,520	6,520	5,800	20,305
	87	77	88	80	70	73	68	78	86
	392	392	392	392	194	194	194	194	482
	464	464	464	464	248	248	356	230	599
	- 40	- 40	- 40	- 40	- 58	-58	- 40	- 58	- 148
	0.60	0.24	0.24	0.24	0.24	0.25	0.24	0.60	0.60
	4	6	4	5	8	13	10	6	4
	> 10 ⁵	< 10 ¹²	> 10 ¹⁵	< 10 ¹³	> 10 ⁸	> 10 ¹²	> 10 ¹⁰	> 10 ⁵	> 10 ⁹
	> 10 ²	< 10 ¹¹	> 10 ¹⁴	< 10 ¹¹	> 10 ⁸	> 10 ¹²	> 10 ¹¹	> 10 ⁵	> 10 ⁹

CUSTOM

iglide® Custom Bearings Yes, we do.



Well over a billion iglide® plastic plain bearings have already been supplied by igus®. The majority are standard sizes, but that does not solve every application. We also produce special solutions with lifetime calculation and with iglide® advantages:

- Maintenance-free
- Self-lubricating
- Low Friction
- Wear resistant



Online Lifetime
Calculation
www.igus.com

Y.E.S.

Young Engineers Support Program

The Y.E.S. Program is designed to foster the mechanical design ideas of students and to educate them on the merits and benefits of plastic components. Through Y.E.S. igus® has reached out to students, competitions and engineering programs from across the United States, Canada and Mexico.

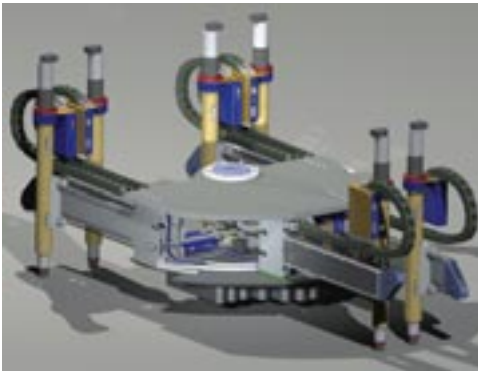

A team from Canada used Energy Chain® while building a walking robot.

For more information,
contact igus® at
1-800-521-2747
or visit
www.igus.com/yesprogram



For this FIRST® Robotics team, DryLin® linear guides and iglide® plastic bearings were a lightweight alternative to metal or bronze bearings and facilitated movement for the robot's forklift.

Through the Y.E.S. Program, igus®:

- ✓ offers free product donations to students, engineers and professors for use in various design competitions, school projects and engineering curriculums;
- ✓ supports the visions of various engineering competitions by donating products, technical support and other resources;
- ✓ revitalizes students' interest in engineering; and
- ✓ aids in making the unique design ideas of students and engineers a reality.

Y.E.S. Facts

- ✓ The Y.E.S. Program is open to students of all ages and grade levels, as well as teams and engineers competing in robotic competitions.
- ✓ The Y.E.S. Program sponsors competitions such as FIRST, BEST, Botball and the SAE Collegiate Design Series.
- ✓ The Y.E.S. Program offers lecture engagements presented by bearings and cable carrier experts at schools and universities across the United States, Canada and Mexico.
- ✓ Students have the opportunity to see their accomplishments featured on the Y.E.S. website by submitting information about the unique application, how they used igus® products and pictures.



A PhD student from the Worcester Polytechnic Institute used DryLin® linear bearings and iglide® plastic bearings to facilitate motion on this MRI-guided robot, which will revolutionize the way prostate cancer is detected and treated.

manus

The North American Plastic Bearing Design Contest



Igus® brought together a panel of experts in science and engineering to uncover and honor the top engineering designs using plastic bearings in new and ingenious ways. The winning applications were chosen from more than 60 entries based on creativity, technical advancement and economic impact. See more applications online at www.igus.com/manus



Six Flags Theme Parks Rollercoaster

The world's only 4th dimensional rollercoaster needed a lubrication-free, maintenance-free bearing due to tight space restrictions. High loads were also a factor, as well as high flexibility to provide the high level of vibration dampening essential for optimal performance. Iglide® Z not only met these requirements, but significantly reduced costs by more than 50 percent and virtually eliminated maintenance.



Harriston Industries Agricultural Machinery

Iglide® J replaced bronze bearings on the company's potato planter, which continually experienced high wear and premature failure due to very abrasive conditions. High salt content in the air was also causing corrosion and seizure. Iglide® J eliminated corrosion and increased lifespan by 500-600 percent at a cost 70-80 percent lower.

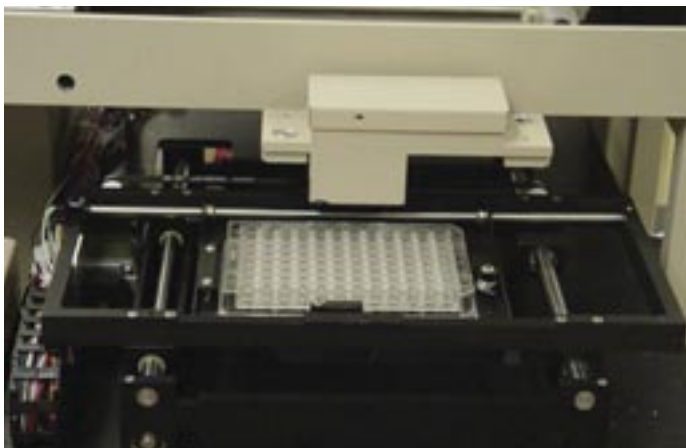

Nova Biomedical Medical Device

The company chose to use DryLin® R bearings on its two-axis tray and both DryLin® R and DryLin® N linear slides on its three-axis probe. Repetitive motion, saltwater contamination, high temperatures and the crucial need for accurate positioning prompted Nova to try DryLin®. The bearings also needed to be lubrication-free to prevent contamination. DryLin's low-cost and ease-of-use were the determining factors.

igus[®]



iglide[®] Design Guide



- High dimensional accuracy
- High compressive strength
- Good heat dissipation
- Low heat relaxation
- Maintenance-free
- High dirt resistance
- Corrosion resistance
- High vibration dampening
- Very low tendency to creep

Plain Bearings Last a Long Time at Low Cost

igus® develops materials that are well-suited to the different requirements of maintenance-free plain bearings:

1. Plain bearings must be able to handle high loads over an extended period of time.
2. Maintenance-free plain bearings should have low coefficients of friction.
3. Plain bearings should have low wear rates to increase life span.

Both in material development as well as in the construction of bearings, former disadvantages of plastics are greatly reduced. Thus, iglide® plain bearings are thin walled and some materials have especially high thermal conductivity. Both features function to rapidly dissipate heat and thus directly increase the load capacity of the bearing.



Every designer's dream: A plain bearing made of high-performance plastics that's lifetime is predicted by real world testing.

The Traditional Solution is:

Hard shells with soft coating. Each lubricated bearing works according to this principle, and likewise a number of maintenance-free bearings, that are equipped with special slide layers. However, this soft slide layer is not strong enough. For high loads, compression across edges or oscillations, it becomes removed.

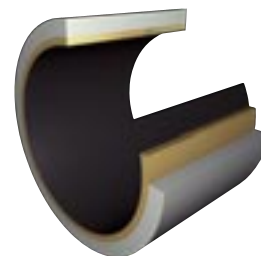

The traditional solution, bearing shells made of layers with lubricants and/or coating.

iglide® Plain Bearings Function Differently

One component of the iglide® materials acts for each function of the bearing:

- The **base plastics** are responsible for the resistance to wear
- **Fibers and filling materials** reinforce the bearing so that high forces or edge loads are possible
- **Solid lubricants**, lubricate the bearing independently and prevent friction of the system



iglide® plain bearings: Exactly the right bearing for every application

Base Plastics and Technical Fibers

The radial pressure, with which the bearings are loaded, is received by the plastic base material. In the contact area, this material provides shaft support. The plastic base material ensures the lubricants do not receive a surface pressure that is too high. The base material is also reinforced by technical fibers or filling materials. These additional materials stabilize the bearing especially for cases of continuous stress.

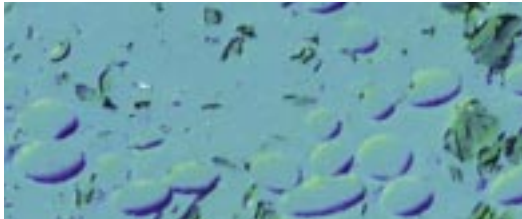

Base plastics with fibers and solid lubricants, magnified 200 times, dyed

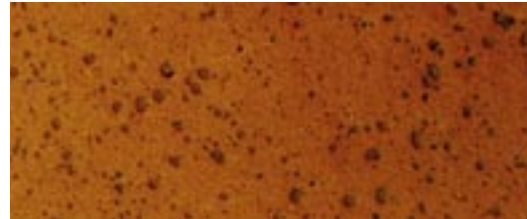

Base plastics without reinforcing materials with solid lubricants, magnified 200 times, dyed.

The Start-up Phase

During the initial start-up phase, the shaft and the iglide® plain bearing become mated to one another. During this phase, the surfaces of both the shaft and the bearing are fitted to each other. The specific loading of the system drops since the contact surfaces of the shaft and bearing expand during the start-up. At the same time, the rate of wear decreases and approaches a linear curve. In this phase, the coefficients of friction continue to change, until finally assuming a value that is for the most part constant.

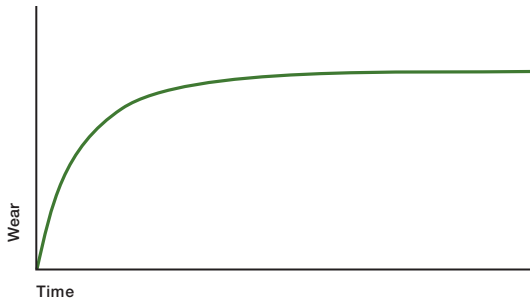

During the start-up phase, the rate of wear drops greatly.

Compressive Strength

The load of a plain bearing is expressed by the surface pressure (psi). For this purpose, the radial load is determined on the projected surface of the bearing.

Radial bearing:
 $p = F / (d1 \times b1)$

For thrust bearings, the load is produced accordingly.

Axial bearing:
 $p = F / (d2^2 - d1^2) \times \pi / 4$

in this process:

- F** load in lbs
- d1** bearing inner diameter in inches
- b1** bearing length in inches
- d2** Outer diameter of the bearing in inches

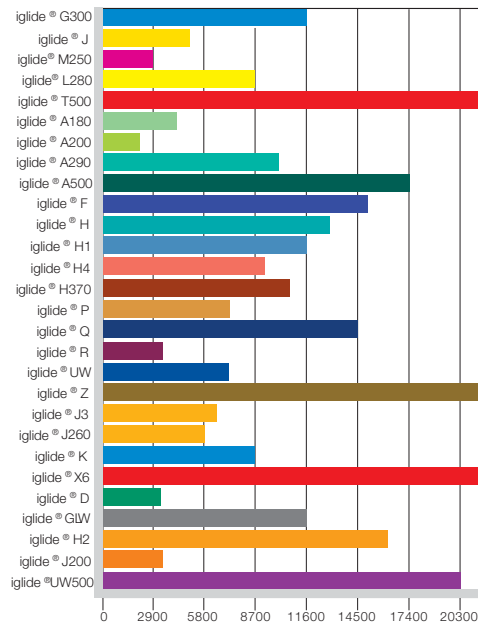

Permissible average static surface pressure at 68°F

Permissible Average Surface Pressure

A comparative value of the iglide® material is the permissible average static surface pressure (p) at 68°F. The values of the individual iglide® plain bearings differ greatly on this point. The value (p) indicates the limit of the load of a plain bearing. The plain bearing can carry this load permanently without damage. The given value applies to static operation, only very slow speeds up to 1.97 fpm are tolerated under this load. Higher loads than those indicated are possible if the duration of the load is short. For a few minutes, the load can be more than doubled, depending on the material. Please call us if you have questions.

iglide® Plain Bearings

PDF: www.igus.com/iglide-pdfs
 CAD: www.igus.com/iglide-CAD
 RoHS info: www.igus.com/RoHS



Pressure and Temperature

The graph to the right shows the permissible static surface pressure (p) of the iglide® plain bearing versus the temperature.

When using the plain bearing, the bearing temperature can be higher than the ambient temperature, due to friction. Take advantage of the opportunity presented by the predictability of the iglide® plain bearing to record these effects in advance, or determine the effective temperatures in the test.



Testing of the compressive strength of iglide® plain bearings

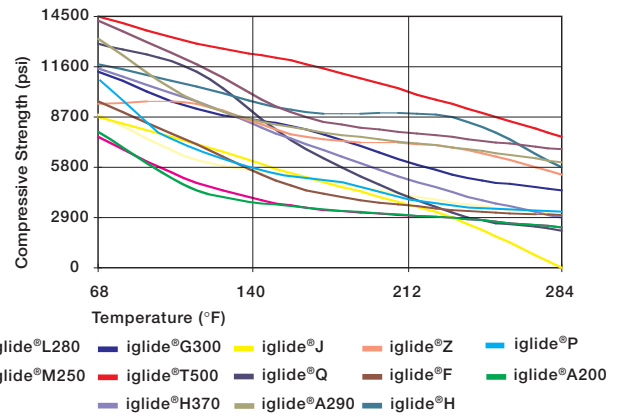

Compression resistance of iglide® plain bearings as a result of temperature

Pressure and Speed

With decreasing radial load on the plain bearing, the permissible surface speed increases. The product of the load (p) and the speed (v) can be understood as a measurement for the frictional heat of the bearing. This relationship is shown by the p x v-graph that is the first in the respective chapter for each iglide® material.

Pressure and Wear

The load of the plain bearing has an effect on the wear of the bearing. The following graphs show the wear behavior of the iglide® bearing materials. It is easily recognized that for each load, there is an optimal plain bearing available.

Pressure and Coefficient of Friction

With increasing load, the coefficient of friction of the plain bearing typically decreases. In this context, shaft materials and surfaces are also significant.

► Coefficients of Friction, Page 1.17

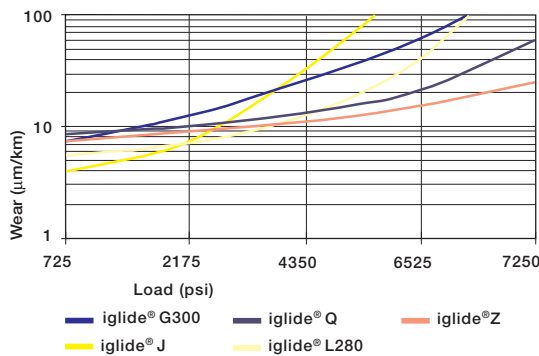

Wear of iglide® plain bearings under medium and high loads

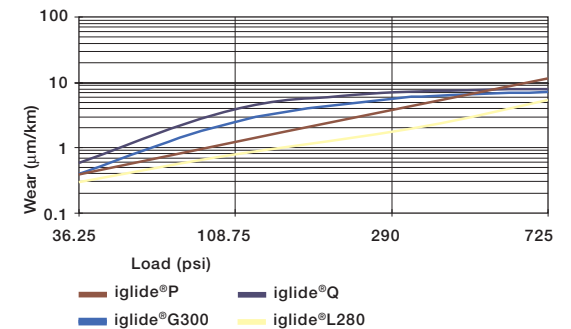
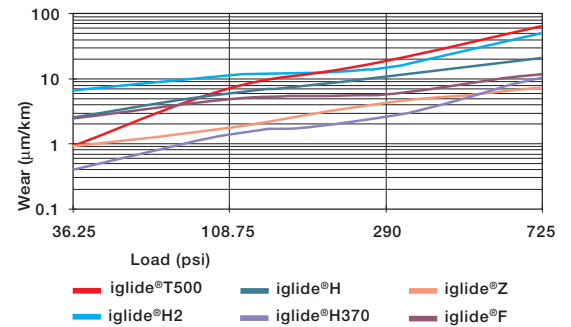
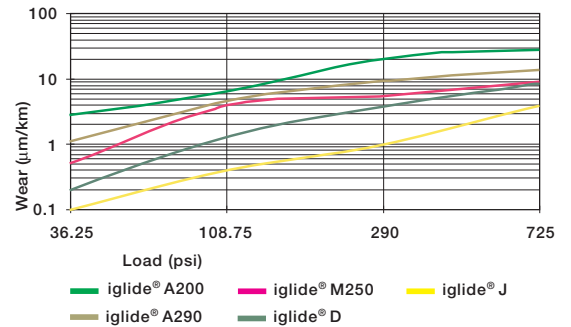

Wear of iglide® plain bearings under low loads

Surface Speed

For plain bearings, the revolution speeds always matter. The absolute rotational speed is not decisive, instead it's the relative speed between the shaft and the bearing. The surface speed is expressed in feet per minute (fpm) and calculated from the rotational speed with the adjacent formula.

Rotations:

$$v = \frac{\text{rpm} \times d1 \times 3.14}{12} = \text{fpm}$$

Oscillating movements:

$$v = \frac{2ab}{360} \times \frac{3.14d}{12} = \text{fpm}$$

in the process:

- a = angle of motion either side of the mean position in degrees
- d1 = Shaft diameter in inches, if mm convert to inches prior to calculation
- b = Frequency in cycle per minute
- d = inner diameter in inches, if mm convert to inches prior to calculation

Permissible Surface Speeds

iglide® plain bearings were primarily developed for low to average running speeds in continuous operation.

The table shows the permissible surface speed of iglide® plain bearings for rotating, oscillating, and linear movements.

These surface speeds are limit values assuming minimum pressure loading of the bearing. In practice, these limit values are rarely reached due to an inverse relationship between load and speed. Each increase of the pressure load leads unavoidably to a reduction of the allowable surface speeds and vice versa.

The limit of the speed is measured by the bearing temperature. This is also the reason why different running speeds can occur for the different movement types. For linear movements, more heat can be dissipated via the shaft, since the bearing uses a longer surface area on the shaft.

Material	Continuous			Short Term		
	Rotating	Oscillating	Linear	Rotating	Oscillating	Linear
iglide® G300	196	138	787	393	275	1043
iglide® L280	196	138	787	492	354	1181
iglide® T500	295	216	984	689	492	1969
iglide® M250	157	118	492	393	275	984
iglide® J	295	216	1574	590	413	1969
iglide® Q	196	137	984	393	275	1181
iglide® H370	236	157	787	295	216	984
iglide® H	196	137	590	295	216	787
iglide® Z	295	216	984	689	492	1181
iglide® P	196	137	590	393	275	787
iglide® F	157	118	590	295	216	984
iglide® A200	157	118	393	295	216	590
iglide® R	157	118	689	236	197	984
iglide® H2	177	118	492	196	137	590
iglide® D	295	216	1574	590	413	1969
iglide® GLW	157	118	492	196	137	590
iglide® X6	295	216	1062	689	492	1969
iglide® A180	157	118	689	236	197	984

Surface speeds of the iglide® plain bearing in fpm

Surface Speed and Wear

Considerations about the permissible surface speeds should also include the wear resistance of the plain bearing. High running speeds automatically bring correspondingly high wear rates with them.

Surface Speed and Coefficient of Friction

The coefficient of friction of plain bearings is a result of the surface speed in practice. High surface speeds have a higher coefficient of friction, than low surface speeds. The graph to the right shows this relationship in the example of a Cold Rolled Steel shaft with a load of 102 psi with 30 and 59 fpm.



Experiments on wear and coefficient of friction using the example of an igubal® pillow block bearing



Determining the maximum surface speeds of an igubal rod end bearing at high rotational speeds

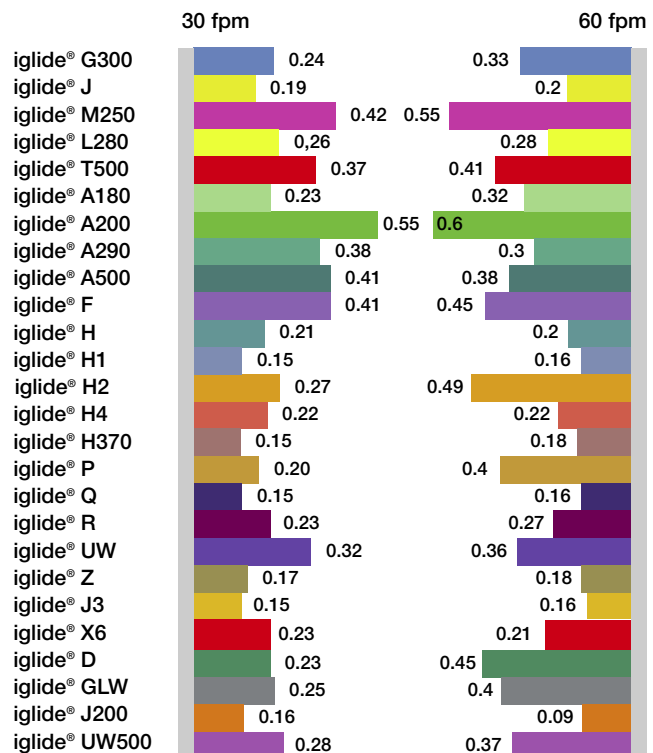

Coefficients of friction of iglide® materials for different surface speeds



P x V-value

For plain bearings, the product is given a new value depending on the specific load (p) and the surface speed (v).

The p x v value can be considered a measure of the frictional heat and can be used as an analytical tool to answer questions concerning the proper application of a plain bearing. For this purpose, the actual p x v value is a function of the shaft material of the ambient temperature and the operating time.

Material	Thermal Conductivity (W/m x k)
Steel	46
Aluminum	204
Gray cast iron	58
303 Stainless	16
Ceramics	1.4
Plastics	0.24

Table 1.2: Heat conductivity values of shaft or housing materials

$$p \times v = \left(\frac{(K1 \times \pi \times \lambda k \times \Delta T)}{\mu \times s} + \frac{(K2 \times \pi \times \lambda s \times \Delta T)}{\mu \times b1 \times 2} \right) \times 10^{-3}$$

Where:

- K1, K2 = constant for heat dissipation (K1 = 0.5, K2 = 0.042)
- s = bearing wall thickness in mm
- b1 = bearing length in mm
- μ = coefficient of friction
- λs = thermal conductivity of the shaft
- λk = thermal conductivity of the bearing
- ΔT = (T_a - T_U)
- T_U = ambient temperature
- T_a = Maximum application temperature

Correction Factor

The tolerated p x v value can be increased in intermittent operation if the bearing temperature never reaches the maximum limit because of the short operating time. Tests have shown that this is true for operating times below 10 minutes. An important qualifier here is the ratio of the operating time and pause intervals. It is known that long pauses make a greater contribution to re-cooling. The different curves of graph 1.9 represent different ratios (3x means that the pause lasts three times longer than the operating time).

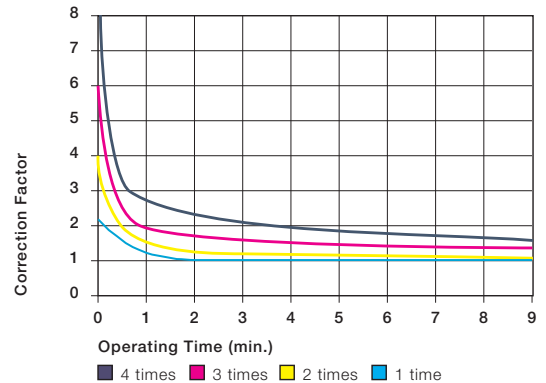

Correction factor for p x v-value

Lubrication

Although iglide® plain bearings are designed to run dry, they are quite compatible with customary oils and greases. A single lubrication during the installation improves the start-up behavior and the coefficient of friction, thus reducing the frictional heat. Due to this effect, the permissible loads for plain bearings can be increased by lubrication. Numerous results from lubricated applications are available from experiments. Please contact us if necessary.

The table below shows the correction factors for p x v value using lubrication.

Lubrication	Correction factor
Dry run	1
During installation	1.3
Continuous, grease	2
Continuous, water	4
Continuous, oil	5

Correction of the tolerated p x v-value by lubrication



Testing the properties of plastic bearings

Temperature

Plain bearings made of high-performance plastics are usually underestimated at higher temperatures. Who would believe that bearings made of plastic could be used up to over 572°F? Data is often found in the literature about the continuous use temperature. The continuous use temperature is the highest temperature, which the plastic can withstand for a period of time without a reduction in the tensile strength of the material above or below a prespecified value. Please note, these standardized test results have limited application, since bearings are almost always under load.

The material wear limits, based on application temperature are made informative.

Application Temperatures

The minimum application temperature is the temperature below which the material is so rigid and hard that it becomes too brittle for standard applications. The maximum continuous application temperature is the temperature which the material can endure without the properties changing considerably.

The maximum, short-term application temperature is the temperature above which the material becomes so soft, that it can only withstand small external loads. "Short-term" is defined as a time period of a few minutes. If the plain bearings are moved axially or axial forces occur, there is more opportunity for the bearing to lose pressfit. In these cases, axial securing of the bearing is necessary in addition to being pressfit.

The tables below show the maximum ambient temperatures to which the plain bearings can be exposed for a short-term. If these temperatures are realized, the bearings may not be additionally loaded.

In fact, a relaxation of the bearings can occur at these temperatures, even without an additional load. Thus it is necessary to ensure that the bearing cannot slide out of the bore. This is achieved by changing the bore construction or additionally securing the bearing.

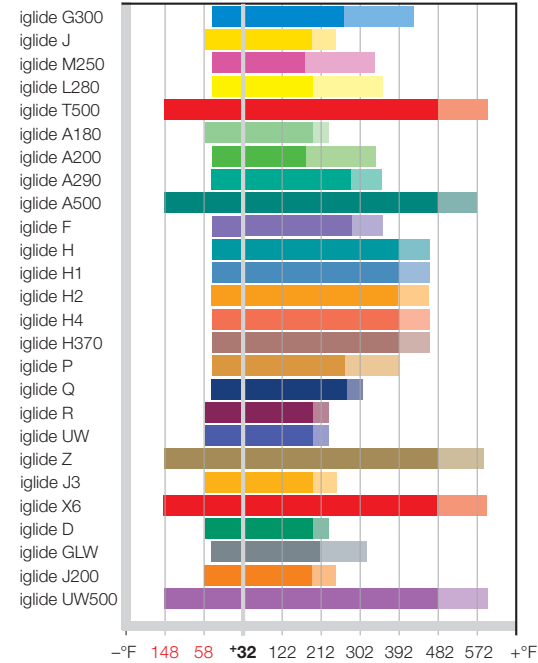
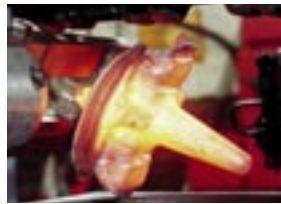

iglide® T500 plain bearing in hard friction setting at high temperatures in foundries

Material	Lower application Temperature (°F)
iglide® G300	- 40
iglide® L280	- 40
iglide® T500	- 148
iglide® M250	- 40
iglide® J	- 58
iglide® Q	- 40
iglide® H370	- 40
iglide® H	- 40
iglide® Z	- 148
iglide® P	- 40
iglide® F	- 40
iglide® A200	- 40
iglide® R	- 58
iglide® H2	- 40
iglide® D	- 58
iglide® GLW	- 40

Lower application temperature of the iglide® materials

Material	Securing mechanism provided starting at (°F)
iglide® G300	212
iglide® L280	140
iglide® T500	275
iglide® M250	140
iglide® J	140
iglide® Q	122
iglide® H370	212
iglide® H	248
iglide® Z	293
iglide® P	194
iglide® F	221
iglide® A200	122
iglide® R	122
iglide® H2	230
iglide® D	122
iglide® GLW	176

Additional securing temperature requirement of the iglide® plain bearing

Material	Maximum, short-term ambient temperature (°F)
iglide® G300	428
iglide® L280	356
iglide® T500	599
iglide® M250	338
iglide® J	248
iglide® Q	311
iglide® H370	464
iglide® H	464
iglide® Z	590
iglide® P	392
iglide® F	356
iglide® A200	338
iglide® R	230
iglide® H2	464
iglide® D	230
iglide® GLW	320

Maximum ambient temperature, short-term, without loading

Temperature and Load

The compressive strength of plain bearings decreases as temperature increases. During this process, the materials react very differently from another, iglide® T500, for example, still accepts loads of 10,150 psi even at temperatures of 392°F.



Material tests are possible up to 482°F

Coefficient of Thermal Expansion

The thermal expansion of plastics is approximately 10 to 20 times higher when compared to metals. In addition to this, it also acts non-linearly in plastics. The coefficient of thermal expansion of the iglide® plain bearing is a significant reason for the required play in the bearing. At the given application temperature, seizing of the bearing to the shaft does not occur at high temperatures. The coefficient of thermal expansion of iglide® plain bearings were examined for significant temperature ranges and the results are given in the individual materials tables, at the start of each chapter.

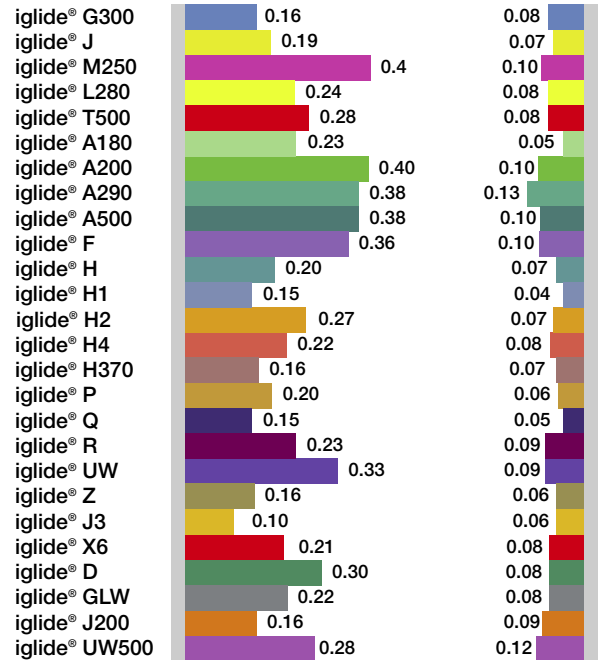

Frictional values of iglide® materials under different loads

Coefficient of Friction

iglide® plain bearings are self-lubricating by the addition of solid lubricants. The solid lubricants lower the coefficient of friction of the plain bearings and thus increase the wear resistance. The coefficient of friction measurement

$$F_R = \mu \times F$$

Depending on whether an application is starting from a stopped position or the movement is in progress and needs to be maintained. A choice is made between static friction coefficient and the dynamic friction coefficient.

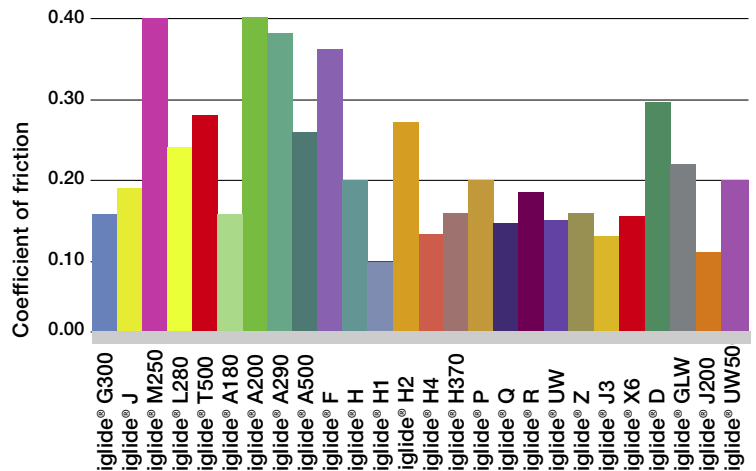

Coefficients of friction of the iglide® plain bearings for the recommended surface roughness and low load, p = 108.75 psi

Coefficients of Friction and Surfaces

At study here is the relationship between coefficients of friction and surface roughness of shaft materials. It is clearly shown that the amount of friction is composed of different factors. If the shaft is too rough, abrasion levels play an important role. Small areas of unevenness that can interlock with each other must be worn off the surface.

When the surfaces are too smooth, however, higher adhesion results, i.e. the surfaces adhere to each other. Higher forces are necessary to overcome the adhesion, which results from an increased coefficient of friction. Stick-slip can be the result of a large difference between static and dynamic friction and of a higher adhesive tendency of mating surfaces. Stick-slip also occurs due to intermittent running behavior and can result in loud squeaking. Stick-slip thus represents a cause for malfunction of plain bearings. Over and over again, it is observed that these noises do not occur or can be eliminated with rough shafts. Thus for applications that have a great potential for stick-slip - slow movements, large resonance of the housings - attention must be paid to the optimal roughness of the shafts.



Friction experiments in the iglus® laboratory

Wear Resistance

Due to the fact that the wear of machine parts is a function of so many different influences, it is difficult to make general statements about the wear behavior. Therefore, in numerous experiments, the wear is of primary importance as a measurement parameter. In testing, it has become clear what variances are possible between different material pairings. For given loads and surface speeds, the wear resistance can easily vary by a factor of 10 between materials pairings that run well together.

► Shaft materials, Page 1.11

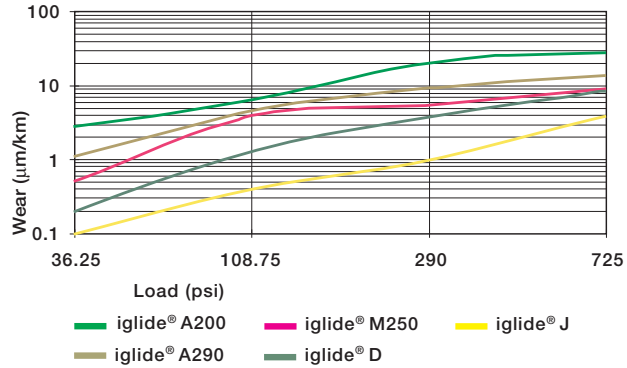

Wear of iglide® plain bearings for small loads, shaft: Cold Rolled Steel, v=19.7 fpm

Wear and Load

Different loads greatly influence the bearing wear. Among the iglide® plain bearings, certain materials are specialized for low loads. While others are better suited for high or extremely high loads. With a hardened, ground shaft, iglide® J can be characterized as the most wear-resistant bearing material for low loads. iglide® Q, on the other hand, is specialized for extreme loads.

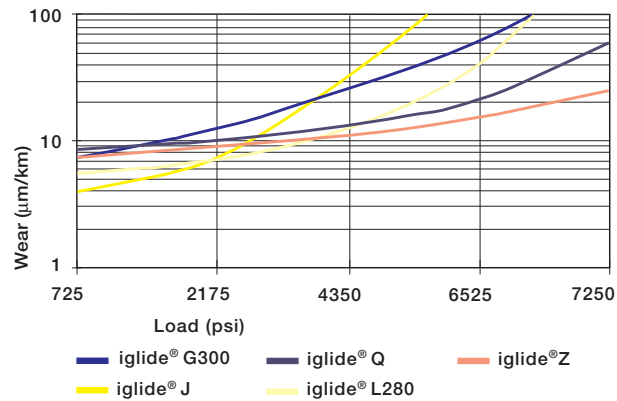

Wear of iglide® plain bearings for medium and high loads, shaft: Cold Rolled Steel, v=19.7 fpm

Wear and Temperature

Within wide temperature ranges, the wear resistance of the iglide® plain bearings shows little change. In the maximum temperature range, however, the temperature increases and the wear of the plain bearing increases exponentially. The table on the following page compares the “wear limits”. One particular exception is represented by iglide® T500. The wear resistance of iglide® T500 increases greatly as temperature increases and reaches the optimum wear resistance at a temperature of 320°F. Then resistance decreases again, gradually.

Material	Wear Limit (°F)	Material	Wear Limit (°F)
iglide® G300	248	iglide® Z	392
iglide® L280	248	iglide® P	212
iglide® T500	410	iglide® F	266
iglide® X6	410	iglide® A180	158
iglide® M250	176	iglide® A200	176
iglide® J	128	iglide® R	248
iglide® Q	176	iglide® H2	248
iglide® H370	302	iglide® D	128
iglide® H	248	iglide® GLW	212

Wear limits of iglide® plain bearings

Wear During Abrasive Dirt Accumulation

Special wear problems frequently occur if abrasive dirt particles get into the bearing. iglide® plain bearings can clearly improve the operating time of machines and systems in these situations. The high wear resistance of the materials and the self-lubrication process provide for the highest service lifetime. Because no oil or grease is on the bearing, dirt particles can not penetrate as easily into the bearing. The largest portion simply falls away from the bearing thus limiting potential damage. If however, a hard particle penetrates into the bearing area, then an iglide® plain bearing can absorb this particle. The foreign body becomes embedded in the wall of the bearing. Up to a certain point, operation can be maintained at optimal levels even when there is extreme dirt accumulation.

However, it's not just hard particles that can damage bearings and shafts. Soft dirt particles such as, for example, textile or paper fibers, are frequently the cause for increased wear. In this instance, the dry running capability and the dust resistance of the iglide® plain bearings go into action. In the past, they were able to help save costs in numerous applications.



High wear resistance: plain bearing in contact with sand



Wear and Surfaces

Shaft surfaces are important for the wear of bearing systems. Similar to the considerations for coefficients of friction, a shaft can be too rough in regard to the bearing wear, but it can also be too smooth. A shaft that is too rough acts like a file and during movement separates small particles from the bearing surface. For shafts that are too smooth, however, higher wear can also occur. An extreme increase in friction results due to adhesion. The forces that act on the surfaces of the sliding partner can be so large that regular material blow-outs occur.

It is significant to note that wear by erosion is non-linear. Moreover, it is subject to chance and can not be accurately predicted in advance.

Shaft Materials

The shaft is, next to the plain bearing itself, the most important parameter in a bearing system. It is in direct contact with the bearing, and like the bearing, it is affected by relative motion. Fundamentally, the shaft is also worn, however, modern bearing systems are designed so that the wear of the shafts is so small that it can not be detected with traditional methods of measurement technology.

Shafts can be distinguished and classified according to their hardness and according to the surface roughness. The effect of the surface is described on the preceding pages:

- ▶ Coefficients of friction, Page 1.8
- ▶ Wear resistance, Page 1.9

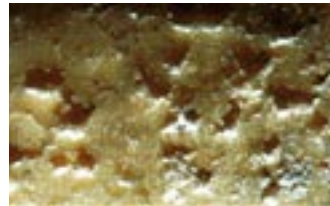

Erosion damage due to shafts that are too smooth



Wear experiments with aluminum shafts

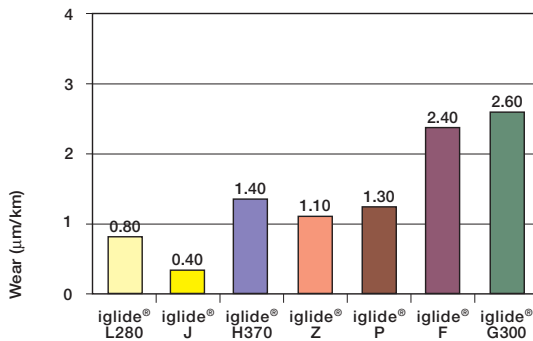

Wear with shaft Cold Rolled Steel,
 $p = 108.75 \text{ psi}$, $v = 98 \text{ fpm}$,
 shaft finish = 8 rms

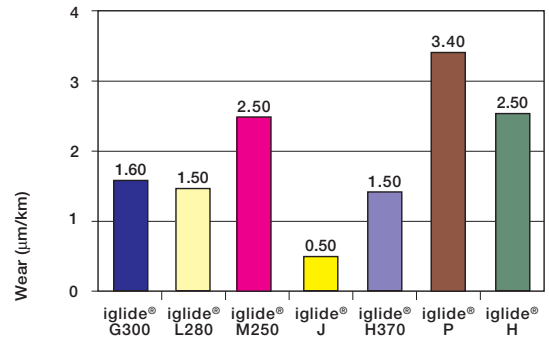

Wear with shaft HR Carbon Steel,
 $p = 108.75 \text{ psi}$, $v = 98 \text{ fpm}$,
 shaft finish = 8 rms

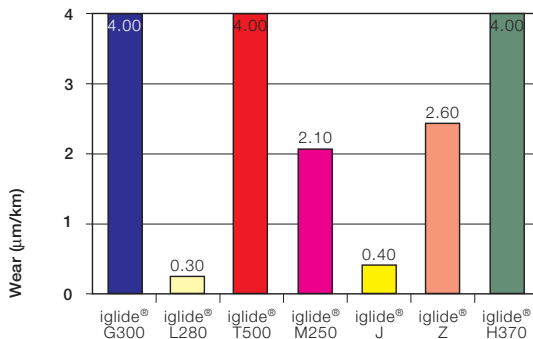

Wear with shaft 303 Stainless Steel,
 $p = 108.75 \text{ psi}$, $v = 98 \text{ fpm}$,
 shaft finish = 8 rms

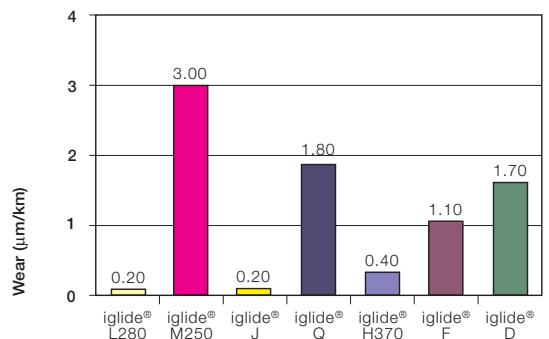

Wear with hard-chromed shaft,
 $p = 108.75 \text{ psi}$, $v = 98 \text{ fpm}$,
 shaft finish = 8 rms

Telephone 1-800-521-2747
 Fax 1-401-438-7270

Internet: <http://www.igus.com>
 email: sales@igus.com
 QuickSpec: <http://www.igus.com/iglide-quickspec>

Shaft Materials (Continued)

The hardness of the shaft also plays an important role. When the shafts are less hard, the shaft is smoothed during the break-in phase. Abrasive points are worn off and the surface is rebuilt. For some materials, this effect has positive influences, and the wear resistance of the plastic bearing increases.

In the following graphs, the most common shaft materials are listed and the iglide® materials that are best suited are compared. For easier understanding, the scaling of the wear axis is the same in all graphs.

Especially impressive is the small wear results of the systems with hard-chromed shafts. This very hard, but also smooth shaft acts beneficially on the wear behavior in many bearing pairs. The wear of many iglide® plain bearings is lower on this shaft than on any other shafting partner tested. However, it should be pointed out that because of the typically small surface roughness, the danger of stick-slip on hard-chromed shafts is especially high.

Such an overwhelmingly positive influence is not as readily available in the other shaft materials. For example, with shafts made of 303 Stainless with low loads, good to very good values can be obtained with the right bearing material. However, it must also be stated that no other shaft material produces a larger variance in wear among the bearing materials. For materials such as 303 Stainless Steel, therefore, the selection of suitable bearing materials is especially important.

Other soft shaft materials, obtain a slightly different view with different bearing materials. With machining steel, the wear values of the seven best iglide® bearing materials are in a narrow range between 0.6 and 1.8. For many other shafts, the influence of the shaft materials is much larger, resulting in a difference, up to 10 times, between the best and the worst of the bearings tested.

If the shaft that you have chosen for your application is missing in this overview, please call us. The test results give only a sample of the existing data. All of the results given were obtained under the same loads and speeds:

All of the results shown were made with the loads $p = 108.75$ psi and $v = 98$ fpm. You can call us for the data for other $p \times v$ combinations.

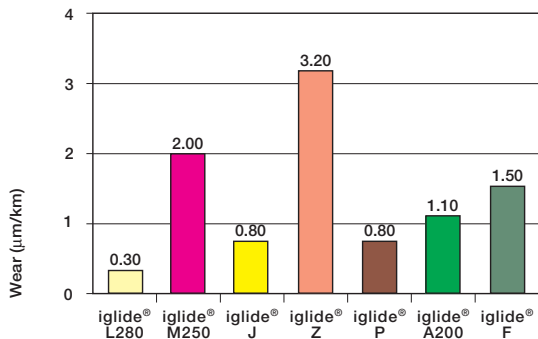

Wear with a silver steel shaft,
 $p=108.75$ psi, $v=98$ fpm, shaft finish = 8 rms

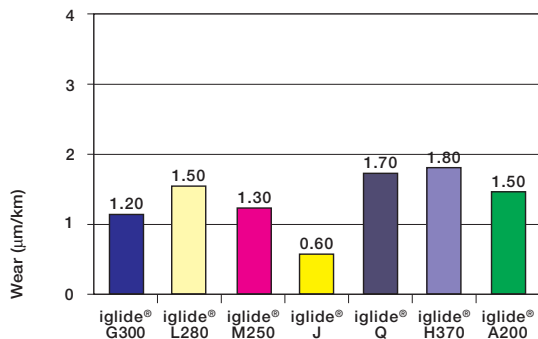

Wear with a machining steel shaft,
 $p=108.75$ psi, $v = 98$ fpm, shaft finish = 8 rms

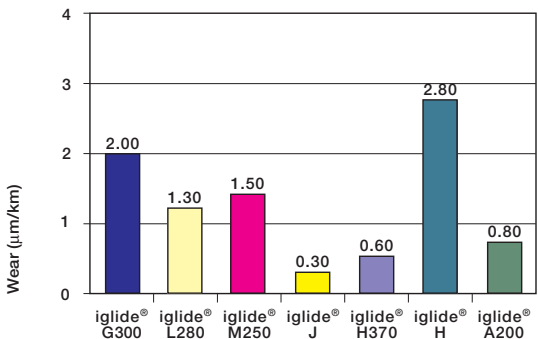

Wear with an aluminum shaft,
 $p=108.75$ psi, $v=98$ fpm, shaft finish = 8 rms

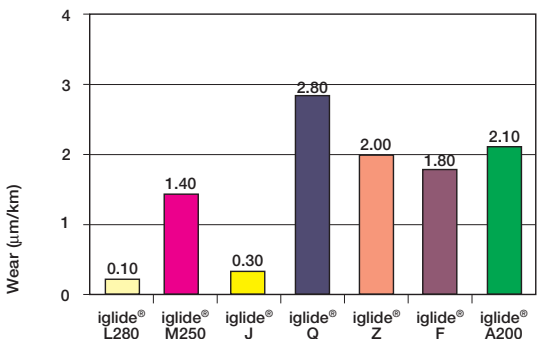

Wear with shaft X90,
 $p = 108.75$ psi, $v = 98$ fpm, shaft finish = 8 rms



Chemical Resistance

iglide® plain bearings can come into contact with many chemicals during their use. This contact can lead to changes of the structural properties. The behavior of plastics toward a certain chemical is dependent on the temperature, the length of exposure, and the type and amount of the mechanical loading. If iglide® plain bearings are resistant against a chemical, they can be used in these media. Sometimes, the surrounding media can even take on the role of a lubricant.

With the most resistant iglide® material, the iglide® T500, the medium can even be hydrochloric acid. All iglide® plain bearings can be used in greatly diluted acids and diluted lyes. Differences can result at higher concentrations or higher temperatures.

For all iglide® plain bearings, their resistance against traditional lubricants applies in the same way. Therefore plain bearings may also be used lubricated. However, in dirty environments, a traditional lubricant can decrease the wear resistance when compared to running dry.

The following overview should quickly assist you:

If it is not completely clear in a design application which of the different chemicals can occur or in which concentration, plain bearings made out of iglide® T500 should be used. They have the best resistance and are only attacked by a few concentrated acids. You'll find a detailed list of chemical resistances in the rear of the catalog

► Chemical resistance, Page 1.16

Material	Diluted Acids	Diluted Lyes	Alcohol	Solvents
iglide® G300	-	+	0	0
iglide® L280	-	+	0	0
iglide® T500	+	+	+	+
iglide® M250	-	0	0	0
iglide® J	0	+	0	0
iglide® Q	0	0	0	0
iglide® H370	+	+	+	+
iglide® H	+	+	+	+
iglide® Z	+	+	+	+
iglide® P	0	0	0	0
iglide® F	0	0	0	0
iglide® A200	-	0	0	0
iglide® R	-	+	0	0
iglide® H2	+	+	+	+
iglide® D®D	0	+	0	0
iglide® GLW	-	+	0	0

Chemical resistance

+ resistant; 0 conditionally resistant; - not resistant



Rotational testing stand for underwater and/or chemicals

Use in the Food Industry

For the special requirements made of machines and systems for producing food and pharmaceuticals, the iglide® product line offers two specially developed bearing materials. iglide® A180, A200, A350 and A500 are all FDA compliant materials.

For all other iglide® plain bearings, direct contact with food should be avoided.

High-Energy Radiation

A comparison of the resistance to radioactive radiation is shown in the adjacent graph. By a wide margin, iglide® T500 and iglide® Z are the most resistant material.

Material	Radiation resistance
iglide® T500, Z	1 x 10 ⁵ Gy
iglide® X6	2 x 10 ⁵ Gy
iglide® A200,	1 x 10 ⁴ Gy
iglide® M250	1 x 10 ⁴ Gy
iglide® P	5 x 10 ² Gy
iglide® G300, A180	3 x 10 ⁴ Gy
iglide® R, J, L280,	3 x 10 ⁴ Gy
iglide® F, Q, D	3 x 10 ⁴ Gy
iglide® H, H2, H370	2 x 10 ² Gy

Comparison of the radiation resistance of iglide® plain bearings

UV Resistance

Plain bearings can be exposed to constant weathering when they are used outside. The UV resistance is an important measure and indicates whether a material is attacked by UV radiation. The effects can extend from slight changes in color to brittleness of the material. A comparison of the materials to each other is shown in the following table. The results show that iglide® plain bearings are suitable for outside use. Only for a few iglide® materials are any changes expected.

Material	Points UV resistance
iglide® G300	+++++
iglide® L280	+++
iglide® T500	+++++
iglide® T500	+++++
iglide® X6	+++++
iglide® M250	++++
iglide® J	+++
iglide® Q	++
iglide® H370	+++++
iglide® H	++
iglide® Z	+++++
iglide® P	+++++
iglide® F	+++++
iglide® A180	+++
iglide® A200	++++
iglide® R	+++++
iglide® H2	+
iglide® D	+++++

UV resistance of iglide® plain bearings

Vacuum

iglide® plain bearings can be used in a vacuum to a limited extent. Only a small amount of outgassing takes place. In most iglide® plain bearings, the outgassing does not change the material properties.

Electrical Properties

In the product line of the maintenance-free, self-lubricating iglide® plain bearings, there are both insulating as well as electrically conductive materials. The most important electrical properties are given in detail in the individual material descriptions. The adjacent table compares the most important electrical properties of iglide® plain bearings.

The iglide® plain bearings not mentioned here are electrically insulating. Please observe that for some materials the properties can be changed by the material's absorption of moisture. In experiments, it should be tested whether the desired properties are also stable when the conditions are changing.

Material	Surface resistance (Ω)
iglide® F	1.5 x 10 ¹
iglide® H	8.8 x 10 ¹
iglide® H370	2.8 x 10 ³
iglide® T500	6.9 x 10 ²

Electrical properties of conductive iglide® plain bearings



Tolerances and Measurement System

The installation dimensions and tolerances of the iglide® plain bearings are a function of the material and wall thicknesses. For each material, the moisture absorption and the thermal expansion are imperative. Plain bearings with low moisture absorption can be obstructed when there is a minimal amount of tolerance. For wall thickness, the rule is: The thicker the bearings are, the larger the tolerances must be.

Thus, different tolerance classes exist for iglide® plain bearings:

Within these tolerances, iglide® plain bearings can operate in the permissible temperature range and in humidity conditions up to 70% according to the installation recommendations. Should higher air moisture levels be present, or the bearing is operated under water, our application advice is available to help you use your bearings correctly.

Dimensions in Microns (1000ths of a mm)

Dimensions	mm	1 / =3		>3 / =6		>6 / = 10		> 10 / = 18		> 18 / = 30		> 30 / = 50		> 50 / = 80	
H 7	mm	+0	+10	+0	+12	+0	+15	+0	+18	+0	+21	+0	+25	+0	+30
E 10	mm	+14	+54	+20	+68	+25	+83	+32	+102	+40	+124	+50	+150	+60	+180
F 10	mm	+6	+46	+10	+58	+13	+71	+16	+86	+20	+104	+25	+125	+30	+150
D 11	mm	+20	+80	+30	+105	+40	+130	+50	+160	+65	+195	+80	+240	+100	+290
f 6	mm	-6	-12	-10	-18	-13	-22	-16	-27	-20	-33	-25	-41	-30	-49
d 13	mm	-20	-160	-30	-210	-40	-260	-50	-320	-65	-395	-80	-470	-100	-560
h 6	mm	-0	-6	-0	-8	-0	-9	-0	-11	-0	-13	-0	-16	-0	-19
h 7	mm	-0	-10	-0	-12	-0	-15	-0	-18	-0	-21	-0	-25	-0	-30
h 9	mm	-0	-25	-0	-30	-0	-36	-0	-43	-0	-52	-0	-62	-0	-74
h 13	mm	-0	-140	-0	-180	-0	-220	-0	-270	-0	-330	-0	-390	-0	-460

Dimensions in inches

Dimensions	inch	0.0393"/=1.181"		>0.1181"/=0.23622"		>0.2362"/=0.3937"		>0.3937"/=.7086"	
H 7	inch	+0.0000	+0.0004	+0.0000	+0.0005	+0.0000	+0.0006	+0.0000	+0.0007
E 10	inch	+0.0006	+0.0021	+0.0008	+0.0027	+0.0010	+0.0033	+0.0013	+0.0040
F 10	inch	+0.0002	+0.0018	+0.0004	+0.0023	+0.0005	+0.0028	+0.0006	+0.0034
D 11	inch	+0.0008	+0.0031	+0.0012	+0.0041	+0.0016	+0.0051	+0.0020	+0.0063
f 6	inch	-0.0002	-0.0005	-0.0004	-0.0007	-0.0005	-0.0009	-0.0006	-0.0011
d 13	inch	-0.0008	-0.0063	-0.0012	-0.0083	-0.0016	-0.0102	-0.0020	-0.0126
h 6	inch	-0.0000	-0.0002	-0.0000	-0.0003	-0.0000	-0.0004	-0.0000	-0.0004
h 7	inch	-0.0000	-0.0004	-0.0000	-0.0005	-0.0000	-0.0006	-0.0000	-0.0007
h 9	inch	-0.0000	-0.0010	-0.0000	-0.0012	-0.0000	-0.0014	-0.0000	-0.0017
h 13	inch	-0.0000	-0.0055	-0.0000	-0.0071	-0.0000	-0.0087	-0.0000	-0.0106

Dimensions	inch	> 0.7086"/=1.18111"		>1.1811"/=1.9685"		>1.9685"/=3.1496"	
H 7	inch	+0.0000	+0.0008	+0.0000	+0.0010	+0.0000	+0.0012
E 10	inch	+0.0016	+0.0049	+0.0020	+0.0059	+0.0024	+0.0071
F 10	inch	+0.0008	+0.0041	+0.0010	+0.0049	+0.0012	+0.0059
D 11	inch	+0.0026	+0.0077	+0.0031	+0.0094	+0.0000	+0.0000
f 6	inch	-0.0008	-0.0013	-0.0010	-0.0016	-0.0012	-0.0019
d 13	inch	-0.0026	-0.0156	-0.0031	-0.0185	0.0000	0.0000
h 6	inch	-0.0000	-0.0005	-0.0000	-0.0006	-0.0000	-0.0007
h 7	inch	-0.0000	-0.0008	-0.0000	-0.0010	-0.0000	-0.0012
h 9	inch	-0.0000	-0.0020	-0.0000	-0.0024	-0.0000	-0.0029
h 13	inch	-0.0000	-0.0130	-0.0000	-0.0154	-0.0000	-0.0181

Testing Methods

iglide® plain bearings are pressfit bearings for bores set to our recommendations. This pressfitting of the bearing affixes the bearing in the housing, and the inner diameter of the plain bearing is also formed upon pressfit.

The bearing test is performed when the bearing is installed in a bore with the minimum specified dimension; both using an indicating caliper and a Go No-Go gauge.

- the “Go-Side” of the Go-No-Go gauge, pressfit into the bore, must pass easily through the bearing
- With the 3 point probe, the inner diameter of the bearing after pressfit must lie within the prescribed tolerance on the measurement plane, See Figure 1.

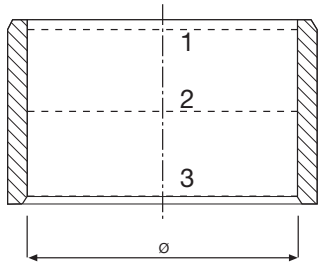

Figure 1: The position of the measurement planes (x=.02 inches)



Measurement of the inner diameter of a pressfit plain bearing

Machining

iglide® plain bearings are delivered ready-to-install. The extensive product line makes it possible to use a standard dimension in most cases. If for some reason, a subsequent machining of the plain bearing is necessary, the table above left shows the machining standard values.

The subsequent machining of the bearing surfaces is to be avoided if possible. Higher wear rate is most often the result. An exception is the iglide® M250, which is very suitable for secondary machining. In other iglide® plain bearings, disadvantages of a sliding surface machining can be counteracted by lubrication during installation.

Process	Turning	Boring	Milling
Cutting material	SS	SS	SS
Forward feed (mm)	0.1...0.5	0.1...0.5	to 0.5
Tool orthogonal clearance	5...15	10...12	
Tool orthogonal rake	0...10	3...5	
Cutting speed (m/min)	656...1640	164...328	to 3281

Guidelines for machining

Installation

iglide® plain bearings are oversized before press-fit. The inner diameter adjusts only after being pressfit in the proper housing bore with the recommended tolerances listed in the catalog. Axial or radial shifts in the housing are also prevented.

Provided the recommended housing bore tolerances are met (as listed next to each part number), the ID after press-fit as indicated will be met. We recommend a metal housing bore preferably steel, with a smooth ID and lead-in chamfer

The installation is done using an arbor press. The use of centering or calibrating pins can cause damage to the bearing and create a larger amount of clearance.



The installation

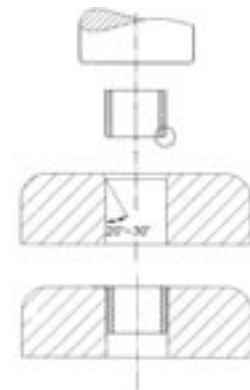

Section view: pressfit of the bearing

Adhesion

Adhering of the bearing is normally not necessary. If the pressfit of the bearing could be lost due to high temperatures, the use of a plain bearing having a higher temperature resistance is recommended.

If however, the securing of the bearing by adhesives is planned, individual tests are necessary in each case. The transfer of successful results to other application cases is not possible.



iglide® Plain Bearings Chemical Resistance Chart

iglide®
Plain Bearings

Telephone 1-800-521-2747
Fax 1-401-438-7270

Internet: <http://www.igus.com>
email: sales@igus.com
QuickSpec: <http://www.igus.com/iglide-quickspec>

Chemicals, iglide®	A180, J200, R, UW, B180	A200, G300, GLW, M250, L280, L250, C, L100, igumid G	A350	A500, UW500, T500, X6, A500	A290, F	J, J3, J4	J260	J350	H, H2, H370, H4	P, P210, K	Q	Z	D
Acetaldehyde (aqueous), 40 %	+	o	x	+	o	+	-	x	x	-	o	x	+
Acetamide (aqueous), 50 %	+	+1	x	+	+1	+	-	x	x	x	+1	x	+
Acetic acid, 2 %	+	-	+	+	-	+	+	+	+	+	o	+	+
Acetic acid, 10 %	+	-	+	+	-	+	+	+	+	+	+	+	+
Acetic acid, 90 %	-	-	+	o	-	-	-	x	+	-	-	+	-
Acetone	+	+	-	+	o	+	-	-	+	-	+	+	o
Acetyl chloride	-	-	x	x	-	-	x	x	x	x	-	x	-
Acrylonitrile	o	+	x	+	+	o	-	x	x	-	+	x	o
Air, liquid	o	o	x	x	o	o	x	x	x	o	o	x	o
Allyl alcohol	+	o	x	+	o	+	x	x	+	+	+	+	+
Aluminum chloride (aq.), 10 %	o	o	x	+	o	o	o	x	+	o	o	x	o
Aluminum cleaner	-	-	x	o	-	-	x	x	o	x	-	x	-
Aluminum salt from mineral acid, 20 %	o	o	x	x	o	o	x	x	x	o	o	x	o
Aluminum sulphate (aq.), 10 %	o	o	x	+	o	o	+	x	+	o	o	+	o
Ammonium carbonate (aqueous), 10 %	+	+1	x	+	+1	+	o	x	+	+	+1	+	+
Ammonium chloride (aq.), 10 %	+	+1	x	+	+1	+	+	x	+	+	+1	+	+
Amyl acetate, 100 %	-	-	x	+	-	-	-	x	+	o	+	+	o
Amyl alcohol	+	+	x	+	+	+	+	x	+	o	+	o	+
Aniline (aqueous), sat'd solution	o	o	x	+	o	o	-	x	+	o	o	x	o
Anisole	o	+	x	+	+	o	-	x	+	x	+	o	o
Anodized liquor (HNO3 -30 %/ H2SO4 -10 %)	-	o	x	x	o	-	x	x	x	o	o	x	-
Aromatics	+	+	+	x	+	+	x	x	x	o	x	x	x
Barium chloride (aqueous), 10 %	+	o	x	+	o	+	+	x	+	+	+1	+	+
Barium salt from mineral acid	+	o	x	x	o	o	x	x	x	o	o	x	o
Barium sulphate (aqueous), 10 %	+	o	x	+	o	+	o	x	+	+	+1	+	+
Benzaldehyde	+	o	x	+	o	o	-	x	o	-	o	x	o
Benzoic acid (aqueous), 20 %	o	o	x	+	o	o	-	x	x	+	o	+	o
Benzyl alcohol	+	+	+	+	+	o	-	+	x	x	o	o	o
Biphenyl	+	+	x	x	+	+	x	x	x	-	x	x	x
Bitumen, DIN 51567	+	o	-	+	o	o	+	x	x	o	o	+	o
Bleaching solution	-	-	x	+	-	-	x	x	x	-	o	+	-
Bleaching solution (aqueous), 10 %	-	-	x	+	-	-	x	x	+	o	o	+	-
Blue vitriol, saturated solution	o	o	+	+	o	o	x	x	+	x	o	+	o
Blue vitriol, 0,5 %	+	o	+	+	o	+	x	x	+	x	o	+	+
Boric acid (aqueous), 10 %	+	o	+	+	o	+	+	x	x	-	+1	+	-
Boring oils	+	+	+	x	+	+	x	x	x	+	x	x	x
Brandy vinegar	o	o	x	+	o	o	x	x	+	o	o	+	o
Bromine (aqueous), 25 %	-	-	x	+	-	-	-	x	-	-	-	o	-
Bromine vapors	-	-	x	x	-	-	x	x	x	-	-	x	-
Butanol	+	+	+	+	+	+	o	x	+	+	+	o	o
Butter	+	+	x	+	+	+	+	x	+	+	+	+	+
Butylacetate	+	+	o	+	o	o	x	x	+	o	o	+	o

Resistance classification: + resistant; o conditionally resistant; - not resistant; x no data available

¹ The bearings are not chemically attacked by these substances. However, there may be a dimensional change due to moisture absorption.

iglide® Plain Bearings Chemical Resistance Chart



iglide®

Chemicals, iglide®	A180, J200, R, UW, B180	A200, G300, GLW, M250, L280, L250, C, L100, igumid G	A350	A500, UW500, T500, X6, A500	A290, F	J, J3, J4	J260	J350	H, H2, H370, H4	P, P210, K	Q	Z	D
Butylglycol	+	+	-	+	+	+	o	x	+	+	+	+	+
Butylglycolat	+	+	x	x	+	+	x	x	x	+	x	x	x
Butyl phthalate	+	+	x	x	+	+	x	x	x	+	x	x	x
Butyric acid	o	o	x	+	o	-	-	x	+	o	-	+	-
Calcium chloride, sat'd solution	+	+1	x	+	+1	+	+	x	+	+	+1	+	+
Calcium hydroxide (aqueous)	+	+	+	x	+	+	x	x	x	+	x	x	x
Calcium hypochlorite	+	+	x	x	+	+	x	x	x	o	x	x	x
Camphor	+	+	x	+	+	+	o	x	+	x	+	+	+
Carbonated ammonia (aqueous), 10 %	+	+	x	+	+	+	x	x	+	x	x	+	+
Carbon dioxide gas	+	+	x	+	+	+	+	x	+	+	x	x	+
Carbon disulphide	+	+	x	+	+	+	x	x	+	x	+	x	+
Catechol (aqueous), 6 %	-	-	x	+	-	-	-	x	x	-	o	o	-
Caustic natron (aqueous), 50 %	o	o	x	+	o	o	x	x	x	x	x	+	o
Caustic potash, 10 %	o	+1	+	x	+1	o	x	x	x	-	x	x	o
Caustic potash, 20 %	-	o	+	+	o	-	-	x	+	-	x	+	-
Caustic potash (aqueous), 40 %	+	+	x	+	+	+	x	x	x	x	x	+	+
Caustic potash, 50 %	-	o	+	x	o	-	x	x	x	-	o	x	-
Caustic soda (aqueous), 10 %	+	-	+	+	-	o	x	x	+	-	o	+	-
Caustic soda (aqueous), 50 %	+	+	+	x	+	+	x	x	x	-	x	x	x
Cellulose paint	+	+	x	x	x	+	x	x	x	x	x	x	+
Chlor, chlorine water	-	-	x	x	-	-	x	x	x	-	-	x	-
Chloramine	x	-	x	x	-	-	x	x	x	-	-	x	-
Chlor bromine methane, 98 %	x	o	x	+	o	x	x	x	x	o	o	x	x
Chlorethanal	-	-	x	x	-	-	x	x	x	-	-	x	-
Chloric gas	-	-	x	-	-	-	-	x	-	-	-	-	-
Chlorine hydrogen gas	-	-	x	x	-	-	x	x	x	-	-	x	-
Chlorine sulfone acid (aqueous)	-	-	x	-	o	-	-	x	-	-	-	+	-
Chlorine water, sat'd solution	-	-	x	+	-	-	o	x	x	-	o	o	-
Chloroacetic acid (aq.), 10 %	-	-	x	+	-	-	-	x	x	-	-	-	-
Chloroform	-	-	-	+	o	-	-	-	o	-	-	o	-
Chromic acid (aqueous), 1 %	o	-	x	+	-	o	o	x	-	o	o	o	o
Chromic acid (aqueous), 10 %	-	-	x	+	-	-	-	x	-	-	-	o	-
Citric acid, concentrate dilution	o	o	x	+	o	o	+	x	o	x	-	+	o
Citric acid (aqueous), 10 %	+	+1	+	+	+1	+	+	x	+	+	o	+	+
Citrus fruits	+	+	x	x	+	+	x	x	x	+	x,	x	x
Cobalt salt (aqueous)	+	+	x	x	+	+	x	x	x	+	x	x	x
Cooking fats, 100 %	+	+	+	+	+	+	x	x	+	+	+	+	+
Cooking oils	+	+	+	+	+	+	x	x	+	+	+	+	+
Cresol	-	-	x	+	-	-	-	x	+	-	-	+	-
Cyclohexane	+	+	+	+	+	+	o	x	+	-	+	+	-
Decahydronaphthaline	+	+	-	+	+	+	x	x	+	-	+	+	-
Dibutyl ether	+	+	x	x	+	+	x	x	x	+	x	x	x
Dibutyl phthalate	+	+	x	+	+	+	-	x	+	+	+	+	+
Dichlor benzene	-	+	x	+	+	-	x	x	+	-	+	o	-
Dichlor ethene	-	+	x	+	+	-	x	x	+	-	+	o	-

iglide®
Plain Bearings

PDF: www.igus.com/iglide-pdfs
CAD: www.igus.com/iglide-CAD
RoHS info: www.igus.com/RoHS



Resistance classification: + resistant; o conditionally resistant; - not resistant; x no data available

¹ The bearings are not chemically attacked by these substances. However, there may be a dimensional change due to moisture absorption.

Chemicals, iglide®	A180, J200, R, UW, B180	A200, G300, GLW, M250, L280, L250, C, L100, igumid G	A350	A500, UW500, T500, X6, A500	A290, F	J, J3, J4	J260	J350	H, H2, H370, H4	P, P210, K	Q	Z	D
Dichlor ethylene	-	-	X	+	-	-	-	X	+	-	-	+	-
Diethylether	O	O	+	+	+	+	-	X	X	+	+	+	O
Dimethylformamide	O	+	+	+	+	+	-	X	+	+	+	+	+
Dioctyl phthalate	+	+	+	+	+	+	X	X	+	O	+	+	O
Dioxane	O	+	X	+	+	O	-	X	+	+	+	+	O
Dioxygen gas, +23 °C, depressurized	+	+	X	+	+	+	+	X	+	+	X	X	+
Ethanal (aqueous), 40 %	+	O	X	X	O	O	X	X	X	O	O	X	O
Ethanol (aqueous), 96 %	+	O	+	+	O	O	+	X	+	-	O	O	+
Ethyl acetate	+	+	-	+	+	+	-	X	+	-	+	+	+
Ethylene	+	+	X	X	+	+	X	X	X	+	X	X	X
Ethylene chloride	+	+	-	+	+	+	-	X	+	-	+	+	+
Ethylene diamine (1,2-Ethane diamine)	+	+	X	+	+	+	O	X	O	+	+	+	O
Ethylene glycole (aqueous), 95 %	+	O	X	+	O	+	O	X	+	+	O	+	+
Ethylene oxide (1,2-Epoxy ethane)	+	O	+	X	O	O	X	X	X	O	O	X	O
Fat, cooking fat	+	+	X	+	+	+	O	X	+	+	+	+	+
Ferric chlorid, saturated solution	+	O	X	X	O	+	X	X	+	X	O	+	+
Ferric chlorid, 2,5 %	+	O	X	X	O	+	X	X	+	X	O	+	+
Ferric chlorid, 5 %	-	O	X	O	O	-	O	X	+	X	O	+	-
Ferric-III-chloride (aqueous), neutral, 10 %	O	+1	X	O	O	O	+	X	+	X	O	+	O
Ferric-III-chloride (aqueous), sour, 10 %	-	-	X	+	+	-	-	X	+	-	O	+	-
Fluorinated hydrocarbons	O	+	X	+	O	+	O	X	+	O	+	O	O
Fluorine	-	-	+	X	-	-	X	X	X	-	-	X	-
Formaldehyde (aqueous), 30 %	+	O	+	+	O	+	+	+	+	+	+1	+	+
Formamide	+	O	-	+	O	+	O	X	X	X	O	+	O
Formic acid (aqueous), 2 %	O	-	X	O	-	-	+	X	+	O	-	O	-
Formic acid, 10 %	-	-	X	-	-	-	X	X	O	-	-	-	-
Formic acid, 90 %	-	-	X	-	-	-	-	X	O	-	-	-	-
Fruit juices	+	+	-	X	+	+	X	X	X	+	X	X	X
Fuming sulfuric acid	-	-	-	-	-	-	-	-	-	-	-	-	-
Furfural	+	O	X	+	O	+	O	X	+	+	+	+	+
Glycerine	-	+	+	+	+	+	O	X	+	+	+	+	+
Glycol	+	O	+	+	O	O	X	X	+	+	O	+	O
Heptane	+	+	+	+	+	+	+	X	+	O	+	+	-
Hexa chlorine ethane	+	+	X	+	+	+	X	X	X	X	+	O	-
Hexachlorobenzene	+	-	X	+	-	-	X	X	X	X	-	O	-
Hexamethylphosphoracidtramid	+	-	X	X	-	-	X	X	X	-	-	X	-
Hexane	+	+	+	+	+	+	+	X	+	-	+	+	-
Humic acid	O	O	X	X	O	O	X	X	X	O	O	X	O
Hydrobromic acid (aqueous), 10 %	-	-	X	+	-	-	-	X	O	-	-	+	-
Hydrochloric acid, L20	-	-	+	X	-	-	X	-	X	O	-	X	-
Hydrochloric acid, 2 %	-	-	+	+	-	-	+	X	-	-	O	+	-
Hydrochloric acid, 10 %	-	-	+	+	-	-	-	O	-	-	-	+	-

Resistance classification: + resistant; o conditionally resistant; - not resistant; x no data available

¹ The bearings are not chemically attacked by these substances. However, there may be a dimensional change due to moisture absorption.

iglide® Plain Bearings Chemical Resistance Chart



iglide®

Chemicals, iglide®	A180, J200, R, UW, B180	A200, G300, GLW, M250, L280, L250, C, L100, igumid G	A350	A500, UW500, T500, X6, A500	A290, F	J, J3, J4	J260	J350	H, H2, H370, H4	P, P210, K	Q	Z	D
Hydrofluoric acid (aqueous), 4 %	-	-	-	+	-	-	-	x	-	-	-	-	-
Hydrogen peroxide, 0,5 %	+	+	+	+	+	+	+	o	+	+	+	+	+
Hydrogen peroxide, 30 %	-	-	+	+	-	-	-	-	-	-	-	-	-
Hydrogen sulphide (aqueous)	+	o	x	x	o	+	x	x	x	o	o	x	-
Hydrogen sulphide (dry)	+	+	+	+	o	x	+	x	+	+	+	+	x
Hydroquinone (aqueous), 5 %	o	-	x	+	-	o	o	x	x	o	-	+	o
Ink, dye, Color	+	+1	-	+	+1	+	+	x	+	+	+1	+	+
Iodine tincture, 3 %	o	-	-	+	-	o	-	x	+	x	o	+	o
Isooctane, 80 %	+	+	+	+	+	+	+	x	+	o	+	+	-
Isopropanol	+	+	+	+	+	+	+	x	+	+	o	o	+
Isopropyl ether	+	+	x	+	+	+	-	x	x	o	+	+	+
Ketone (aliphatic)	+	o	+	x	o	o	x	x	x	-	o	x	o
“Königswasser” HCl/HNO3 (75/50 vol.)	-	-	x	x	-	-	x	x	x	-	-	x	-
Lead acetate (diluted), 10 %	+	o	x	+	o	+	+	x	x	o	o	+	+
Lead stearate	+	+	x	+	+	+	+	x	+	+	+	+	+
Linseed oil	+	+	+	+	+	+	+	x	+	+	+	+	+
Lithium bromide/chloride/salts (aqueous), 50 %	+	o	x	+	o	+	+	x	x	o	o	+	+
Lithium chloride in alcohol, 20 %	+	-	x	x	-	-	x	x	x	x	-	x	-
Lubricating oil, mineral	+	+	+	+	+	+	+	x	+	o	+	+	+
Lubricating oil, synthetic	o	o	x	+	o	o	o	x	+	-	+	+	o
Magnesium chloride (aq.), 10 %	+	+1	x	+	+1	+	+	x	+	+	+1	+	+
Magnesium hydroxyde (aqueous)	+	+1	x	+	+1	+	+	x	+	+	+	+	+
Maleic acid, concentrate solution	o	-	x	+	-	o	o	x	+	x	o	+	o
Maleic acid (aqueous), 10 %	-	o	x	x	o	-	x	x	x	-	o	x	-
Malt	+	+	x	x	+	+	x	x	x	+	x	x	x
Manganese sulphate (aq.), 10 %	+	o	x	+	o	+	x	x	+	x	+	+	+
Mercurous chloride, 6 %	-	-	x	+	-	-	+	x	o	o	-	x	-
Mercury	+	+	x	+	+	+	+	x	+	+	+	+	+
Methane	+	+	+	+	+	+	+	+	+	+	x	x	+
Methanol	+	+	+	x	+	+	x	+	x	+	x	x	x
Methanol, +20 % CaCl2 or LiCl	+	-	x	o	o	o	-	x	o	+	o	o	+
Methyl acetate	o	+	x	+	+	o	x	x	+	o	+	+	o
Methylamine	+	+	x	x	+	+	x	x	x	+	x	x	x
Methylene chloride	o	-	-	x	-	-	x	-	+	-	-	o	-
Methyl ethyl ketone	o	+	-	+	+	o	-	-	+	-	+	+	o
Milk	+	+1	+	+	+1	+	+	x	+	+	+1	+	+
Milk acid (lactic acid), 10 %	+	+	+	+	+	+	+	x	+	+	o	+	o
Milk acid (lactic acid), 90 %	+	o	o	+	o	o	+	x	+	o	o	+	o
Molasses	+	+	+	x	+	+	x	+	x	+	x	x	x
Molykote lubricating grease	+	+	x	+	+	+	x	x	+	x	+	+	+
Mortar, cement, chalk	+	+	x	x	+	+	x	x	x	+	x	x	x
Naphthalene	+	+	x	+	+	+	o	x	+	+	+	+	+
Naphtalene sulfone acid	-	-	x	x	-	-	x	x	x	-	x	-	-

iglide®
Plain Bearings

PDF: www.igus.com/iglide-pdfs
CAD: www.igus.com/iglide-CAD
RoHS info: www.igus.com/RoHS



Resistance classification: + resistant; o conditionally resistant; - not resistant; x no data available

¹ The bearings are not chemically attacked by these substances. However, there may be a dimensional change due to moisture absorption.

Chemicals, iglide®	A180, J200, R, UW, B180	A200, G300, GLW, M250, L280, L250, C, L100, igumid G	A350	A500, UW500, T500, X6, A500	A290, F	J, J3, J4	J260	J350	H, H2, H370, H4	P, P210, K	Q	Z	D
Natrium oleate	+	+	x	x	+	+	x	x	x	+	x	x	x
Natrium sulphate, 10 %	+	+1	x	+	+1	+	+	x	+	+	+1	+	+
Natrium sulphite, neutral, 2 %	o	+1	x	+	+1	o	o	x	+	o	+1	+	o
Natrium thiosulphate, 10 %	+	+1	-	+	+1	+	+	x	+	+	+1	+	+
Nickelsalt (aqueous), 10 %	+	o	x	x	o	+	x	x	x	x	o	x	-
Nitric acid (aqueous), L50	-	-	x	x	-	-	x	x	x	-	-	x	-
Nitric acid (aqueous), 2 %	-	-	+	+	-	-	o	+	-	-	-	+	-
Nitric acid (aqueous), 5 %	-	-	x	+	-	-	-	x	-	-	-	+	-
Nitro acetic acid	+	+	x	x	+	+	x	x	x	+	x	x	x
Nitrobenzene	o	-	-	+	-	o	-	x	o	-	o	-	-
Nitrogases	-	o	x	x	o	-	x	x	x	x	o	x	-
Nitromethane	-	o	x	+	o	-	x	x	o	-	x	+	-
Nitro paints, danger class A I	+	o	x	x	o	+	x	x	x	o	o	x	-
Nitro paints, danger class A II	+	+	x	x	+	+	x	x	x	o	x	x	x
Nitrotoluene	o	o	x	x	o	o	x	x	x	-	o	x	o
Nitrous gases (dry)	-	o	x	x	o	-	x	x	x	o	o	x	-
Noble gases (argon, helium, neon)	+	+	x	x	+	+	x	x	x	+	x	x	x
Octane	x	+	?	x	+	+	x	x	x	+	x	x	x
Oleic acid	+	+	x	+	+	+	+	x	+	+	+	+	+
Oxalic acid (aqueous), 10 %	x	o	+	+	o	x	+	x	x	+	o	+	x
Ozon	-	-	-	+	-	-	+	x	-	-	-	+	-
Palmitic acid	+	+	x	x	+	+	x	x	x	+	x	x	x
Paraffin	+	+	x	x	+	+	x	x	x	+	x	x	x
Paraffin oil	+	+	+	+	+	+	+	x	+	-	+	+	-
Pebble hydrofluoric acid (aqueous), 30 %	x	-	x	x	-	-	x	x	x	-	-	x	-
Perchlorethene	-	-	-	+	-	-	-	-	x	-	-	+	-
Perchloric acid, 10 %	-	-	x	+	-	-	-	x	x	-	-	+	-
Perfume	+	+	x	x	+	+	x	x	x	+	x	x	x
Phenol (aqueous), 6 %	-	-	-	x	-	-	-	x	+	-	-	+	-
Phenol (aqueous), 70 %	-	-	x	o	-	-	-	x	+	-	-	+	-
Phenol (aqueous), 88 %	-	-	-	x	-	-	x	x	x	x	-	x	-
Phosphoric acid (aqueous), 0,3 %	+	o	x	+	o	+	+	x	o	-	o	+	-
Phosphoric acid (aqueous), 3 %	+	o	x	+	-	o	+	x	o	-	o	+	-
Phosphoric acid (aqueous), 10 %	-	-	-	+	-	-	o	x	-	-	-	+	-
Phthalic acid, saturated solution	+	o	x	+	o	+	o	x	o	+	o	+	+
Polyester resin (with styrene)	o	+	x	+	+	+	-	x	+	o	+	+	o
Porpenoic acid	o	-	x	x	-	-	x	x	x	-	-	x	-
Potassium bromide (aq.), 10 %	+	o	x	+	o	o	+	x	+	o	+1	+	+
Potassium carbonate (aq.), 60 %	+	+1	x	+	+1	+	+	x	+	o	+1	+	+
Potassium chloride (aq.), 10 %	+	+1	x	x	+1	+	x	x	x	+	x	x	x
Potassium chloride (aq.), 90 %	+	+1	x	+	+1	+	+	x	+	+	+1	+	+
Potassium dichromate (aq.), 5 %	+	o	-	+	o	o	+	x	+	o	o	+	+
Potassium nitrate (aq.), 10 %	+	+1	x	+	+1	+	+	x	+	+	+1	+	+

Resistance classification: + resistant; o conditionally resistant; - not resistant; x no data available

¹ The bearings are not chemically attacked by these substances. However, there may be a dimensional change due to moisture absorption.

iglide® Plain Bearings Chemical Resistance Chart



iglide®

Chemicals, iglide®	A180, J200, R, UW, B180	A200, G300, GLW, M250, L280, L250, C, L100, igumid G	A350	A500, UW500, T500, X6, A500	A290, F	J, J3, J4	J260	J350	H, H2, H370, H4	P, P210, K	Q	Z	D
Potassium permanganate (aqueous), 1 %	+	-	-	+	-	+	+	X	-	+	o	+	+
Potassium sulphate, sat'd solution	+	+1	X	+	+1	+	+	X	+	o	+1	+	+
Propane, Propene	+	+	X	+	+	+	-	X	+	+	+	+	+
Propanol	+	+	-	+	+	+	+	X	o	+	+	o	+
Pyridine	o	+	-	+	+	o	-	X	+	X	+	+	o
Pyruvic acid (aqueous), 10 %	X	o	X	X	o	X	X	X	X	o	o	X	-
Resorcin (1,3-Dihydroxybenzol), 50 %	X	-	X	X	-	-	X	X	X	-	-	X	-
Salicyl acid	-	+	-	+	+	-	+	X	+	-	+	+	-
Seawater	+	+	+	X	+	+	X	+	X	+	X	X	X
Sebum	+	+	X	+	+	+	+	X	+	+	+	+	+
Silikon oils	+	+	+	+	+	+	+	X	+	+	+	+	+
Silver nitrate	+	+1	X	+	+1	+	+	X	+	o	+1	+	+
Soap solutions	+	+1	+	+	+1	+	+	X	+	+	+1	+	+
Soda solution, 10 %	+	+1	+	+	+1	+	X	X	+	+	+1	+	+
Sodium acetate (aqueous), 10 %	+	-	X	+	+1	+	+	X	+	o	+	+	+
Sodium bisuphite (aqueous), 10 %	+	+1	-	+	+1	+	o	X	+	+	+1	+	+
Sodium bromide (aqueous), 10 %	+	+1	X	+	+1	+	+	X	+	+	+1	+	+
Sodium carbonate, 5 %	+	+1	-	+	+1	+	+	X	+	+	+1	+	+
Sodium carbonate (aqueous), 21,5 %	+	+1	-	+	+1	+	+	X	+	+	+1	+	+
Sodium carbonate (aqueous), 50 %	+	+1	-	+	+1	+	+	X	+	+	+1	+	+
Sodium chlorate (aqueous), 10 %	+	o	X	X	o	o	X	X	X	o	o	X	o
Sodium chloride, sat'd solution	+	+1	X	+	+1	+	+	X	+	+	+1	+	+
Sodium dichromate (aq.), 10 %	X	o	X	X	o	X	X	X	X	o	o	X	-
Sodium dodecylbenzolsulfonat	+	+	X	X	+	+	X	X	X	+	X	X	X
Sodium hypochlorite (aq.), 10 %	-	-	X	+	-	-	o	X	o	o	o	X	o
Sodium hypophosphite (aqueous), 10 %	+	+	X	X	+	+	X	X	X	+	X	X	X
Sodium nitrate (aqueous), 10 %	+	+1	-	+	+1	+	+	X	+	+	+1	+	+
Sodium nitrilotriacetate (aqueous), 10 %	+	+	X	X	+	+	X	X	X	+	X	X	X
Sodium salts, 10 %	+	+	X	X	+	+	X	X	X	+	X	X	X
Soldering fluid	-	-	X	X	-	-	X	X	X	-	-	X	-
Spirit, white	+	+	X	+	+	+	o	X	+	+	+	+	+
Steam	X	-	o	+	-	X	o	X	+	-	o	o	X
Styrene	o	+	X	+	+	o	-	X	+	-	+	+	-
Sulphur	+	+	X	+	+	+	+	X	+	+	+	+	+
Sulphur acid, 2 %	-	-	+	o	-	-	o	+	o	-	-	+	-
Sulphur acid, 10 %	-	-	+	o	-	-	o	o	-	-	-	+	-
Sulphuric acid (concentrate), 98 %	-	-	-	-	-	-	-	X	-	-	-	o	-
Tar	+	+	+	+	+	+	o	X	+	+	+	+	+

iglide®
Plain Bearings

PDF: www.igus.com/iglide-pdfs
CAD: www.igus.com/iglide-CAD
RoHS info: www.igus.com/RoHS



Resistance classification: + resistant; o conditionally resistant; - not resistant; x no data available

¹ The bearings are not chemically attacked by these substances. However, there may be a dimensional change due to moisture absorption.

Chemicals, iglide®	A180, J200, R, UW, B180	A200, G300, GLW, M250, L280, L250, C, L100, igumid G	A350	A500, UW500, T500, X6, A500	A290, F	J, J3, J4	J260	J350	H, H2, H370, H4	P, P210, K	Q	Z	D
Tetrahydrofurane (solvent)	o	+	-	+	+	o	-	x	+	+	+	+	o
Tetraline	+	+	x	+	+	+	x	x	+	-	+	+	-
Thionyl chloride	o	o	-	+	o	o	-	x	x	x	o	x	o
Toluene	o	+	o	+	+	o	-	o	+	-	+	+	-
Transformer oil	+	+	+	+	+	+	o	x	+	+	+	+	+
Trichloroacetic acid (aq.), 50 %	-	-	x	x	-	-	x	x	x	-	-	x	-
Trichloroethanoic	-	o	x	+	o	-	x	x	+	-	o	o	-
Trichloroethylene	-	-	-	+	-	-	-	-	o	-	-	+	-
Triethanolamine, 90 %	+	+1	-	+	+1	+	+	x	+	+	+1	+	+
Trisodiumphosphate, 90 %	+	+	x	+	+	+	+	x	+	+	+	+	+
Uranium fluoride	-	-	x	x	-	-	x	x	x	-	-	x	-
Urea	+	+	x	+	+	+	+	x	+	+	+	+	+
Uric acid (aqueous), 10 %	+	+	+	x	+	+	x	x	x	+	x	x	x
Urine	+	+	+	+	+	+	+	+	+	+	+	+	+
Vaseline	o	o	+	+	+	+	o	x	+	o	+	+	o
Violet oil	+	+	x	+	+	+	x	x	+	x	+	+	+
"Washing machine cleaner"													
(phosphoric and nitric acid)	+	o	x	+	o	-	x	x	+	+	o	+	-
Water glasses (Sodium silicate)	+	+1	x	+	+1	+	+	x	+	+	+1	+	+
Wax, molten	+	+	+	+	+	+	+	+	+	+	+	+	+
Wine acid	o	o	+	+	o	+	+	x	+	x	+1	+	o
Xylene	o	o	+	+	+	o	-	x	+	-	+	+	-
Zinc chloride (aqueous), 10 %	+	o	+	+	o	+	+	x	+	x	-	+	+
Zinc oxide	+	+	x	+	+	+	+	x	+	+	+	+	+
Zinc sulphate (aqueous), 10 %	+	+1	x	+	+1	+	+	x	+	+	+1	+	+

Resistance classification: + resistant; o conditionally resistant; - not resistant; x no data available

¹ The bearings are not chemically attacked by these substances. However, there may be a dimensional change due to moisture absorption.

The data was determined using laboratory specimens or based on comparisons with similar chemicals. Therefore, this data can only act as a reference. The chemical resistance of actual parts should be tested under application conditions. All data given concerns the chemical resistance at room temperature. Other temperatures may lead to different classifications of the chemical resistance. The data is based on our current knowledge. Future discoveries may lead to changes in the classification of the chemical resistance.

Resistance classification: + resistant; o conditionally resistant; - not resistant; x no data available

¹ The bearings are not chemically attacked by these substances. However, there may be a dimensional change due to moisture absorption.

Troubleshooting

In spite of careful manufacturing and assembly of the bearings, variances and questions regarding the recommended installation dimensions and tolerances can result.

For this reason, we have compiled a list of the most frequent reasons for variance. In many cases, with this troubleshooter, the reasons for the variances can be found quickly.

Symptom	Action/Solution
Bearing is oversized before pressfit	Check dimensions only after pressfit
Removal of material when pressed into housing	Add chamfer to housing bore, check bore size
Bearing is over/under sized after pressfit	Check housing bore dimension, check housing bore material Softer bore materials (plastic, aluminum can expand upon pressfit
Operating Clearances are too large/small	Check ID of bearing after press, housing bore, shaft diameter
Bearing noise/squeak	Check shaft surface finish/ Possibly roughen shaft
Bearing wears, material deposits on shaft	Operating clearance may be too small/ Increase clearance
Chattering noise	Operating clearance too large, excessive speed/Reduce speed and operating clearance
Shaft wear	Shaft material too soft/ Change shaft material or hardness, switch to alternative iglide material
Bearing seizes on shaft	Operating clearances too small, temperature or moisture may be causing material expansion
Loss of pressfit	Bearings overheated/ Axial secure bearing into housing or select alternative material grade



iglide®



iglide®
Plain Bearings

Telephone 1-800-521-2747
Fax 1-401-438-7270

Internet: <http://www.igus.com>
email: sales@igus.com
QuickSpec: <http://www.igus.com/iglide-quickspec>

igus[®]



iglide[®] M250

Product Range

- Standard Styles:
Sleeve, Flange and Thrust Washer
- Custom shapes and sizes available
- Inner diameters:
Inch sizes from 1/8 - 2-1/4 in.
Metric sizes from 1 - 75 mm

Part Number Structure

Part Number Structure

M S I-02 03-03

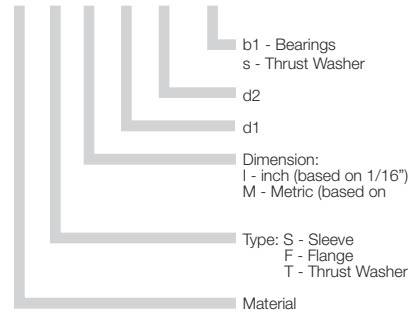

Permissible Surface Speeds

	Continuous fpm	Short Term fpm
Rotating	157	393
Oscillating	118	275
Linear	492	984

Usage Guidelines



- When the bearings are exposed to high amounts of dirt
- When high vibration dampening is necessary
- For low to average speeds
- For edge loads
- When mechanical reaming of the ID is necessary



- When very high precision is necessary
➤ iglide® P
- For very smooth shafts
➤ iglide® J
- When high moisture is present
➤ iglide® R



Visit www.igus.com
to use our online
expert system

Material Table

General Properties	Unit	iglide® M250	Testing Method
Density	g/cm ³	1.14	
Color		charcoal	
Max. moisture absorption at 73°F / 50% r.h.	% weight	1.4	DIN 53495
Max. moisture absorption	% weight	7.6	
Coefficient of friction, dynamic against steel	μ	0.1 - 0.3	
p x v value, max. (dry)	psi x fpm	3,400	

Mechanical Properties

Modulus of elasticity	psi	391,600	DIN 53457
Tensile strength at 68°F	psi	16,240	DIN 53452
Compressive strength	psi	7,540	
Permissible static surface pressure (68°F)	psi	2,901	
Shore D-hardness		79	DIN 53505

Physical and Thermal Properties

Max. long-term application temperature	°F	176	
Max. application temperature, short-term	°F	338	
Min. application temperature	°F	-40	
Thermal conductivity	W/m x K	0.24	ASTM C 177
Coefficient of thermal expansion	K ⁻¹ x 10 ⁻⁵	10	DIN 53752

Electrical Properties

Specific volume resistance	Ωcm	> 10 ¹³	DIN IEC 93
Surface resistance	Ω	> 10 ¹¹	DIN 53482

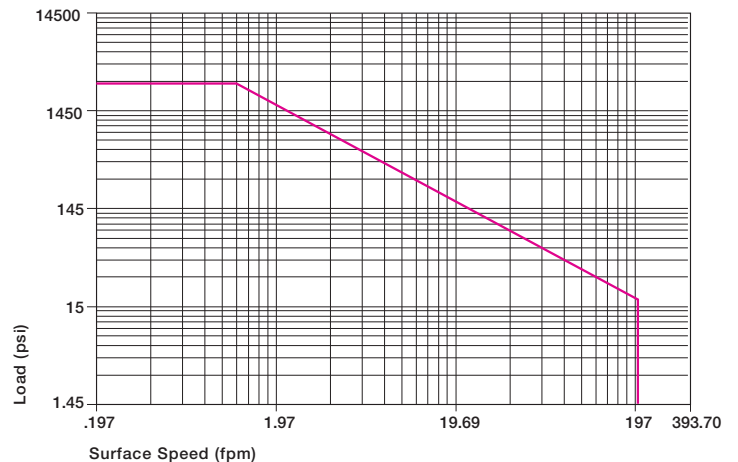

Graph 2.1: Permissible p x v value for iglide® M250 running dry against a steel shaft, at 68°F

The self-lubricating plain bearings made of iglide® M250 are defined by their impact strength, vibration dampening, and wear resistant properties. They excel in applications in which vibration dampening is necessary, for example, in fitness and packaging machines. Since they are additionally able to absorb dirt, they are also suited for agricultural machines and garden appliances.

Compressive Strength

iglide® M250 plain bearings can withstand radial loads of a maximum 2900 psi. The material deformation is below 2% at room temperature. Compared with other iglide® materials, iglide® M250 bearings are highly elastic. By this elasticity, they are able to yield very well, but retain their original shape again. Plastic deformation is minimal up to the permissible surface pressure.

► Compressive Strength, Page 1.3

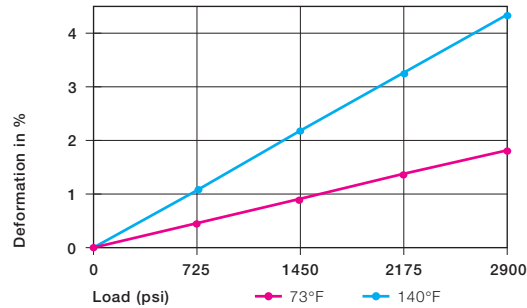

Graph 2.2: Deformation under load and temperature

Permissible Surface Speeds

iglide® M250 is manufactured standard as a thick walled bearing. iglide® M250 is best suited for low to medium surface speeds. The maximum permissible speed for dry running applications is 157 fpm (rotating) or 393 fpm (linear).

► Surface Speed, Page 1.5
► P x V value, Page 1.6

	Continuous fpm	Short Term fpm
Rotating	157	393
Oscillating	118	275
Linear	492	984

Table 2.2: Maximum surface speeds

Temperatures

The maximum permissible short-term temperature is 338°F. However, iglide® M250 plain bearings may only be exposed to this temperature without any additional load. The long-term permissible application temperature is 176°F. This is also the location of the wear limit, i.e. the temperature at which the wear increases exponentially.

► Applications Temperatures, Page 1.7

iglide® M250	Application Temperature
Minimum	- 40°F
Max. long-term	+ 176°F
Max. short-term	+ 338°F

Table 2.3: Temperature limits for iglide® M250

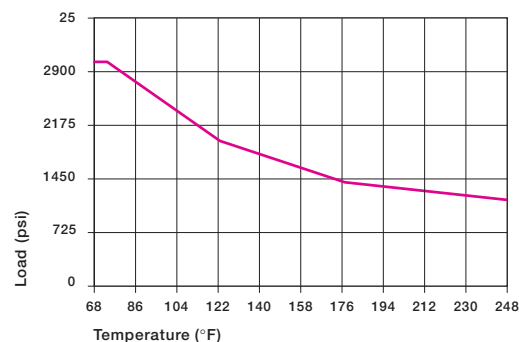

Graph 2.3: Recommended maximum permissible static surface pressure of iglide® M250 as a result of the temperature

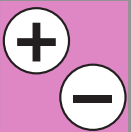

iglide® M250

Telephone 1-800-521-2747
Fax 1-401-438-7270

Internet: <http://www.igus.com>
email: sales@igus.com
QuickSpec: <http://www.igus.com/iglide-quickspec>

Installation Tolerances

iglide® M250 plain bearings are oversized before being pressfit. After proper installation into a recommended housing bore, the inner diameter adjusts to meet our specified tolerances. Please adhere to the catalog specifications for housing bore and recommended shaft sizes. This will help to ensure optimal performance of iglide® plain bearings.

- See Tolerance Table, Page 1.14
- Testing Methods, Page 1.15

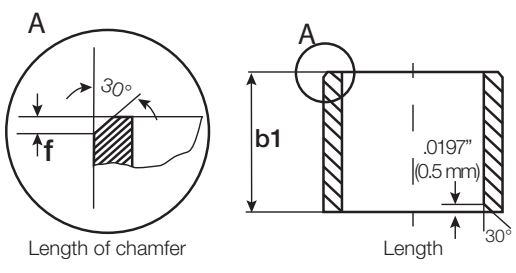

For Inch Size Bearings		
Length Tolerance (b1)		Length of Chamfer (f)
Length (inches)	Tolerance (h13) (inches)	Based on d1
0.1181 to 0.2362	-0.0000 /-0.0071	f = .012 → d ₁ .040" - .236"
0.2362 to 0.3937	-0.0000 /-0.0087	f = .019 → d ₁ > .236" - .472"
0.3937 to 0.7086	-0.0000 /-0.0106	f = .031 → d ₁ > .472" - 1.18"
0.7086 to 1.1811	-0.0000 /-0.0130	f = .047 → d ₁ > 1.18"
1.1811 to 1.9685	-0.0000 /-0.0154	
1.9685 to 3.1496	-0.0000 /-0.0181	

For Metric Size Bearings		
Length Tolerance (b1)		Length of Chamfer (f)
Length (mm)	Tolerance (h13) (µm)	Based on d1
1 to 3	-0 /-140	f = 0.3 → d ₁ 1 - 6 mm
> 3 to 6	-0 /-180	f = 0.5 → d ₁ > 6 - 12 mm
> 6 to 10	-0 /-220	f = 0.8 → d ₁ > 12 - 30 mm
> 10 to 18	-0 /-270	
> 18 to 30	-0 /-330	
> 30 to 50	-0 /-390	
> 50 to 80	-0 /-460	

Friction and Wear

The coefficient of friction μ of a plain bearing is among other things, influenced by the surface speed and the load. If the load stays constant, then the coefficient of friction increases with increasing speed (see Graph 2.4). On the other hand, an increase in the load at constant speed can result in a reduction in the coefficient of friction (see Graph 2.5). Friction and wear are also greatly dependent on the surface of the shaft. For iglide® M250 a ground surface with an average roughness of 24 rms is recommended for the shaft.

- Coefficients of Friction and Surfaces, Page 1.8
- Wear Resistance, Page 1.9

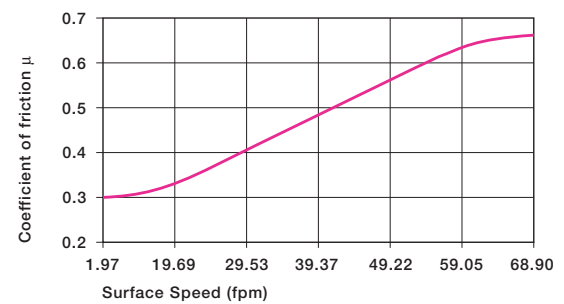

Graph 2.4: Coefficient of friction of iglide® M250 as a result of the surface speed; p = 108 psi

iglide® M250	Coefficient of Friction
Dry	0.18 - 0.40
Grease	0.09
Oil	0.04
Water	0.04

Table: Coefficients of friction iglide® M250 against steel (Shaft finish = 40 rms, 50 HRC)

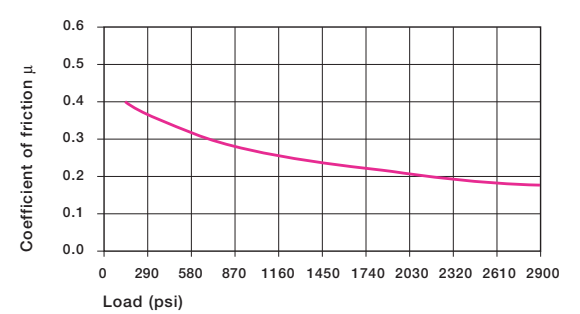

Graph 2.5: Coefficient of friction of iglide® M250 as a result of the load, v = 1.97 fpm

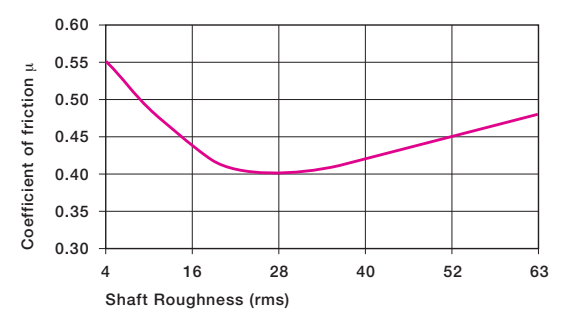

Graph 2.6: Coefficient of friction for iglide® M250 as a result of the shaft surface (shaft Cold Rolled Steel)

Shaft Materials

Graph 2.7 to 2.9 show results of testing different shaft materials with plain bearings made of iglide® M250.

Up to loads of 290 psi, the shaft material plays a relatively small role for rotational movements. Graph 2.7 best illustrates which shaft materials are best suited for smaller loads.

If the load increases, the wear of a bearing clearly increases. Therefore, a suitable shaft material must be considered for higher loads. These are hardened shafts, such as, for example, Cold Rolled Steel or hard-chromed shafts.

Graph 2.9 makes it clear that iglide® M250 is considerably better for rotational than for oscillating operation. However, it must be mentioned that in oscillating movements, often the vibrations that act on the bearings are especially high. Here, iglide® M250 can utilize its special dampening properties. In our test, these vibrations are excluded so that the comparison between rotation and oscillating operation is captured first.

➤ Shaft Materials, Page 1.11

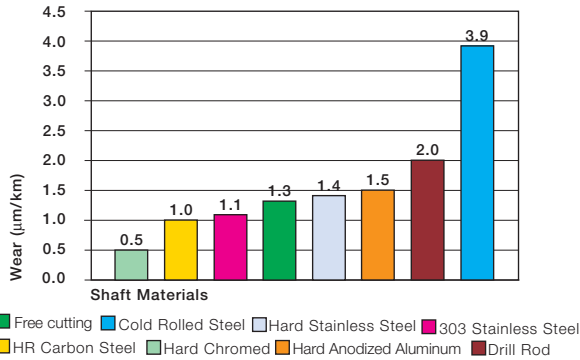

Graph 2.7: Wear for iglide® M250, rotating with different shaft materials, p = 108 psi, v=98 fpm

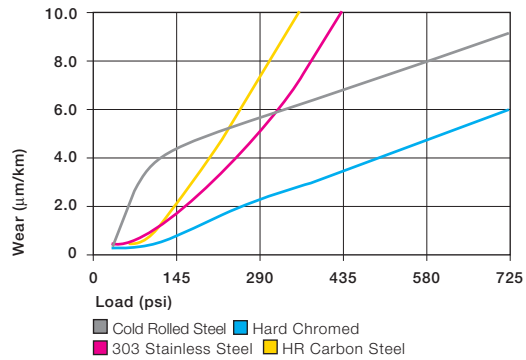

Graph 2.8: Wear of iglide® M250 with different shaft materials in rotational operation

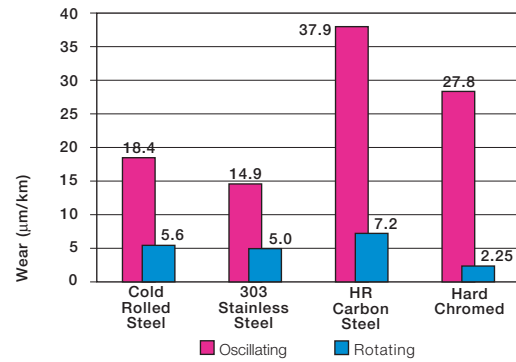

Graph 2.9: Wear for oscillating and rotating applications with different shaft materials at p = 290 psi

Chemical & Moisture Resistance

iglide® M250 plain bearings have a good resistance to chemicals. They are resistant to most lubricants. They are not affected by most weak organic and inorganic acids

The moisture absorption of iglide® M250 plain bearings is approximately 1.4% in standard atmosphere. The saturation limit in water is 7.5%. This must be taken into account along with other applicable conditions.

➤ Chemical Resistance, Page 1.16

Medium	Resistance
Alcohol	+ to 0
Hydrocarbon, chlorinated	+
Greases, oils without additives	+
Fuels	+
Weak acids	0 to -
Strong acids	-
Weak alkaline	+
Strong alkaline	0

+ resistant, 0 conditionally resistant, - not resistant

Table 2.5: Chemical resistance of iglide® M250
All data given concerns the chemical resistance at room temperature (68°F). For a complete list, see page 1.16

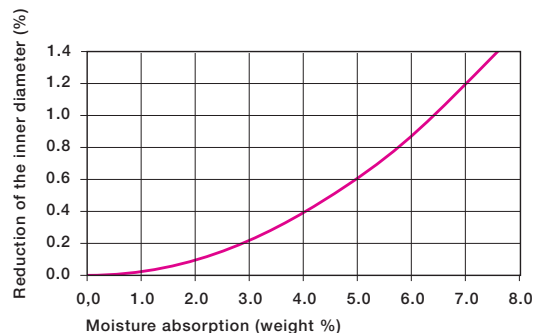

Graph 2.10: Effect of moisture absorption on iglide® M250 plain bearings

Radiation Resistance

Plain bearings made from iglide® M250 can be used conditionally under radioactive radiation. They are resistant to radiation up to a radiation intensity of 1000 Gy.

UV Resistance

iglide® M250 plain bearings are permanently resistant to UV radiation.

Vacuum

In a vacuum environment, the iglide® M250 plain bearing releases moisture as vapor. The relatively high moisture absorption of the bearing allows only limited use in the vacuum.

Electrical Properties

iglide® M250 plain bearings are electrically insulating.

iglide® M250

Specific volume resistance	> 10 ¹³ Ωcm
Surface resistance	> 10 ¹¹ Ω

Table 2.6: Electrical properties of iglide® M250

Application Examples



Picture 2.1: Paper dust in this mail sorting device always led to an early malfunction of the previous bearings used. Problem solved.



Picture 2.2: Precision mechanical gears need plain bearings with especially universal properties



Picture 2.3: In this analytical pump, sewage water is tested with chemicals and floating particles

iglide® Plain Bearings M250 - Sleeve Bearing, Inch

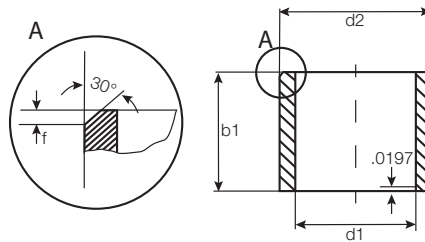

For tolerance values
please refer to page 2.4

iglide® M250
Sleeve - Inch

Part Number	d1	d2	b1	I.D. After Pressfit		Housing Bore		Shaft Size	
				Max.	Min.	Max.	Min.	Max.	Min.
MSI-0203-02	1/8	3/16	1/8	.1280	.1262	.1880	.1875	.1250	.1241
MSI-0203-04	1/8	3/16	1/4	.1280	.1262	.1880	.1875	.1250	.1241
MSI-0204-02	1/8	1/4	1/8	.1280	.1262	.2515	.2510	.1250	.1241
MSI-0204-03	1/8	1/4	3/16	.1280	.1262	.2515	.2510	.1250	.1241
MSI-0204-04	1/8	1/4	1/4	.1280	.1262	.2515	.2510	.1250	.1241
MSI-0204-06	1/8	1/4	3/8	.1280	.1262	.2515	.2510	.1250	.1241
MSI-0304-04	3/16	1/4	1/4	.1905	.1887	.2515	.2510	.1875	.1866
MSI-0304-06	3/16	1/4	3/8	.1905	.1887	.2515	.2510	.1875	.1866
MSI-0304-08	3/16	1/4	1/2	.1905	.1887	.2515	.2510	.1875	.1866
MSI-0305-02	3/16	5/16	1/8	.1905	.1887	.3140	.3135	.1875	.1866
MSI-0305-03	3/16	5/16	3/16	.1905	.1887	.3140	.3135	.1875	.1866
MSI-0305-04	3/16	5/16	1/4	.1905	.1887	.3140	.3135	.1875	.1866
MSI-0305-05	3/16	5/16	5/16	.1905	.1887	.3140	.3135	.1875	.1866
MSI-0305-06	3/16	5/16	3/8	.1905	.1887	.3140	.3135	.1875	.1866
MSI-0305-08	3/16	5/16	1/2	.1905	.1887	.3140	.3135	.1875	.1866
MSI-0405-03	1/4	5/16	3/16	.2539	.2516	.3140	.3135	.2500	.2491
MSI-0405-04	1/4	5/16	1/4	.2539	.2516	.3140	.3135	.2500	.2491
MSI-0405-06	1/4	5/16	3/8	.2539	.2516	.3140	.3135	.2500	.2491
MSI-0405-08	1/4	5/16	1/2	.2539	.2516	.3140	.3135	.2500	.2491
MSI-0406-02	1/4	3/8	1/8	.2539	.2516	.3765	.3760	.2500	.2491
MSI-0406-03	1/4	3/8	3/16	.2539	.2516	.3765	.3760	.2500	.2491
MSI-0406-04	1/4	3/8	1/4	.2539	.2516	.3765	.3760	.2500	.2491
MSI-0406-05	1/4	3/8	5/16	.2539	.2516	.3765	.3760	.2500	.2491
MSI-0406-06	1/4	3/8	3/8	.2539	.2516	.3765	.3760	.2500	.2491
MSI-0406-08	1/4	3/8	1/2	.2539	.2516	.3765	.3760	.2500	.2491
MSI-0406-10	1/4	3/8	5/8	.2539	.2516	.3765	.3760	.2500	.2491
MSI-0406-12	1/4	3/8	3/4	.2539	.2516	.3765	.3760	.2500	.2491
MSI-0506-03	5/16	3/8	3/16	.3164	.3141	.3765	.3760	.3125	.3116
MSI-0506-04	5/16	3/8	1/4	.3164	.3141	.3765	.3760	.3125	.3116
MSI-0506-06	5/16	3/8	3/8	.3164	.3141	.3765	.3760	.3125	.3116
MSI-0506-08	5/16	3/8	1/2	.3164	.3141	.3765	.3760	.3125	.3116
MSI-0507-03	5/16	7/16	3/16	.3164	.3141	.4390	.4385	.3125	.3116
MSI-0507-04	5/16	7/16	1/4	.3164	.3141	.4390	.4385	.3125	.3116
MSI-0507-05	5/16	7/16	5/16	.3164	.3141	.4390	.4385	.3125	.3116
MSI-0507-06	5/16	7/16	3/8	.3164	.3141	.4390	.4385	.3125	.3116
MSI-0507-08	5/16	7/16	1/2	.3164	.3141	.4390	.4385	.3125	.3116
MSI-0507-10	5/16	7/16	5/8	.3164	.3141	.4390	.4385	.3125	.3116
MSI-0507-12	5/16	7/16	3/4	.3164	.3141	.4390	.4385	.3125	.3116
MSI-0607-04	3/8	7/16	1/4	.3789	.3766	.4390	.4385	.3750	.3741
MSI-0607-06	3/8	7/16	3/8	.3789	.3766	.4390	.4385	.3750	.3741
MSI-0607-08	3/8	7/16	1/2	.3789	.3766	.4390	.4385	.3750	.3741

PDF: www.igus.com/iglide-pdfs
CAD: www.igus.com/iglide-CAD
RoHS info: www.igus.com/RoHS

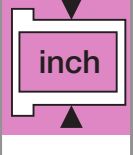
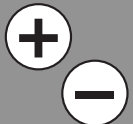

M250



iglide® Plain Bearings
M250 - Sleeve Bearing, Inch

iglide® M250

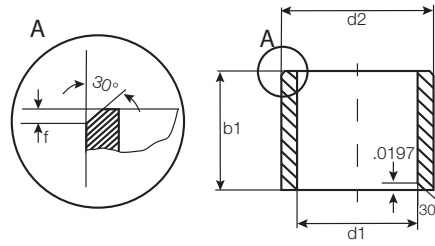

For tolerance values
please refer to page 2.4

Telephone 1-800-521-2747
Fax 1-401-438-7270

Internet: <http://www.igus.com>
email: sales@igus.com
QuickSpec: <http://www.igus.com/iglide-quickspec>

Part Number	d1	d2	b1	I.D. After Pressfit		Housing Bore		Shaft Size	
				Max.	Min.	Max.	Min.	Max.	Min.
MSI-0608-03	3/8	1/2	3/16	.3789	.3766	.5015	.5010	.3750	.3741
MSI-0608-04	3/8	1/2	1/4	.3789	.3766	.5015	.5010	.3750	.3741
MSI-0608-05	3/8	1/2	5/16	.3789	.3766	.5015	.5010	.3750	.3741
MSI-0608-06	3/8	1/2	3/8	.3789	.3766	.5015	.5010	.3750	.3741
MSI-0608-08	3/8	1/2	1/2	.3789	.3766	.5015	.5010	.3750	.3741
MSI-0608-10	3/8	1/2	5/8	.3789	.3766	.5015	.5010	.3750	.3741
MSI-0608-12	3/8	1/2	3/4	.3789	.3766	.5015	.5010	.3750	.3741
MSI-0608-16	3/8	1/2	1	.3789	.3766	.5015	.5010	.3750	.3741
MSI-0709-06	7/16	9/16	3/8	.4422	.4395	.5635	.5625	.4375	.4365
MSI-0709-08	7/16	9/16	1/2	.4422	.4395	.5635	.5625	.4375	.4365
MSI-0810-04	1/2	5/8	1/4	.5047	.5020	.6260	.6250	.5000	.4990
MSI-0810-05	1/2	5/8	5/16	.5047	.5020	.6260	.6250	.5000	.4990
MSI-0810-06	1/2	5/8	3/8	.5047	.5020	.6260	.6250	.5000	.4990
MSI-0810-08	1/2	5/8	1/2	.5047	.5020	.6260	.6250	.5000	.4990
MSI-0810-10	1/2	5/8	5/8	.5047	.5020	.6260	.6250	.5000	.4990
MSI-0810-12	1/2	5/8	3/4	.5047	.5020	.6260	.6250	.5000	.4990
MSI-0810-16	1/2	5/8	1	.5047	.5020	.6260	.6250	.5000	.4990
MSI-1012-04	5/8	3/4	1/4	.6297	.6270	.7510	.7500	.6250	.6240
MSI-1012-06	5/8	3/4	3/8	.6297	.6270	.7510	.7500	.6250	.6240
MSI-1012-08	5/8	3/4	1/2	.6297	.6270	.7510	.7500	.6250	.6240
MSI-1012-10	5/8	3/4	5/8	.6297	.6270	.7510	.7500	.6250	.6240
MSI-1012-12	5/8	3/4	3/4	.6297	.6270	.7510	.7500	.6250	.6240
MSI-1012-16	5/8	3/4	1	.6297	.6270	.7510	.7500	.6250	.6240
MSI-1012-26	5/8	3/4	1 5/8	.6297	.6270	.7510	.7500	.6250	.6240
MSI-1013-06	5/8	13/16	3/8	.6297	.6270	.8135	.8125	.6250	.6240
MSI-1013-08	5/8	13/16	1/2	.6297	.6270	.8135	.8125	.6250	.6240
MSI-1013-10	5/8	13/16	5/8	.6297	.6270	.8135	.8125	.6250	.6240
MSI-1013-12	5/8	13/16	3/4	.6297	.6270	.8135	.8125	.6250	.6240
MSI-1013-16	5/8	13/16	1	.6297	.6270	.8135	.8125	.6250	.6240
MSI-1113-12	11/16	13/16	3/4	.6921	.6894	.8135	.8125	.6875	.6865
MSI-1113-14	11/16	13/16	7/8	.6921	.6894	.8135	.8125	.6875	.6865
MSI-1113-16	11/16	13/16	1	.6921	.6894	.8135	.8125	.6875	.6865
MSI-1214-06	3/4	7/8	3/8	.7559	.7525	.8760	.8750	.7500	.7490
MSI-1214-12	3/4	7/8	3/4	.7559	.7525	.8760	.8750	.7500	.7490
MSI-1214-16	3/4	7/8	1	.7559	.7525	.8760	.8750	.7500	.7490
MSI-1214-24	3/4	7/8	1 1/2	.7559	.7525	.8760	.8750	.7500	.7490
MSI-1216-06	3/4	1	3/8	.7559	.7525	1.0010	1.0000	.7500	.7490
MSI-1216-08	3/4	1	1/2	.7559	.7525	1.0010	1.0000	.7500	.7490
MSI-1216-10	3/4	1	5/8	.7559	.7525	1.0010	1.0000	.7500	.7490
MSI-1216-12	3/4	1	3/4	.7559	.7525	1.0010	1.0000	.7500	.7490
MSI-1216-16	3/4	1	1	.7559	.7525	1.0010	1.0000	.7500	.7490
MSI-1216-20	3/4	1	1 1/4	.7559	.7525	1.0010	1.0000	.7500	.7490

iglide® Plain Bearings M250 - Sleeve Bearing, Inch

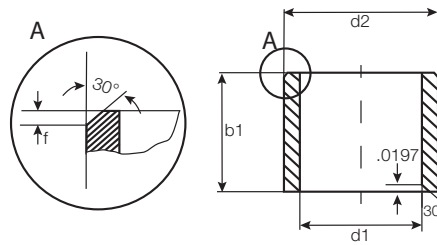

For tolerance values
please refer to page 2.4

iglide® M250
Sleeve - Inch

Part Number	d1	d2	b1	I.D. After Pressfit		Housing Bore		Shaft Size	
				Max.	Min.	Max.	Min.	Max.	Min.
MSI-1216-24	3/4	1	1 1/2	.7559	.7525	1.0010	1.0000	.7500	.7490
MSI-1316-08	13/16	1	1/2	.8184	.8151	1.0010	1.0000	.8126	.8116
MSI-1416-12	7/8	1	3/4	.8809	.8775	1.0010	1.0000	.8750	.8740
MSI-1416-16	7/8	1	1	.8809	.8775	1.0010	1.0000	.8750	.8740
MSI-1416-24	7/8	1	1 1/2	.8809	.8775	1.0010	1.0000	.8750	.8740
MSI-1418-08	7/8	1 1/8	1/2	.8809	.8775	1.1260	1.1250	.8750	.8740
MSI-1418-12	7/8	1 1/8	3/4	.8809	.8775	1.1260	1.1250	.8750	.8740
MSI-1418-16	7/8	1 1/8	1	.8809	.8775	1.1260	1.1250	.8750	.8740
MSI-1418-24	7/8	1 1/8	1 1/2	.8809	.8775	1.1260	1.1250	.8750	.8740
MSI-1618-12	1	1 1/8	3/4	1.0059	1.0025	1.1260	1.1250	1.0000	.9990
MSI-1618-16	1	1 1/8	1	1.0059	1.0025	1.1260	1.1250	1.0000	.9990
MSI-1618-24	1	1 1/8	1 1/2	1.0059	1.0025	1.1260	1.1250	1.0000	.9990
MSI-1620-08	1	1 1/4	1/2	1.0059	1.0025	1.2510	1.2500	1.0000	.9990
MSI-1620-10	1	1 1/4	5/8	1.0059	1.0025	1.2510	1.2500	1.0000	.9990
MSI-1620-12	1	1 1/4	3/4	1.0059	1.0025	1.2510	1.2500	1.0000	.9990
MSI-1620-16	1	1 1/4	1	1.0059	1.0025	1.2510	1.2500	1.0000	.9990
MSI-1620-24	1	1 1/4	1 1/2	1.0059	1.0025	1.2510	1.2500	1.0000	.9990
MSI-1620-32	1	1 1/4	2	1.0059	1.0025	1.2510	1.2500	1.0000	.9990
MSI-1822-16	1 1/8	1 3/8	1	1.1309	1.1275	1.3760	1.3750	1.1250	1.1240
MSI-1822-24	1 1/8	1 3/8	1 1/2	1.1309	1.1275	1.3760	1.3750	1.1250	1.1240
MSI-2024-12	1 1/4	1 1/2	3/4	1.2600	1.2531	1.5005	1.4995	1.2500	1.2490
MSI-2024-16	1 1/4	1 1/2	1	1.2600	1.2531	1.5005	1.4995	1.2500	1.2490
MSI-2024-22	1 1/4	1 1/2	1 3/8	1.2600	1.2531	1.5005	1.4995	1.2500	1.2490
MSI-2024-24	1 1/4	1 1/2	1 1/2	1.2600	1.2531	1.5005	1.4995	1.2500	1.2490
MSI-2024-40	1 1/4	1 1/2	2 1/2	1.2600	1.2531	1.5005	1.4995	1.2500	1.2490
MSI-2226-16	1 3/8	1 5/8	1	1.3844	1.3782	1.6255	1.6245	1.3750	1.3740
MSI-2428-12	1 1/2	1 3/4	3/4	1.5100	1.5032	1.7505	1.7495	1.5000	1.4990
MSI-2428-16	1 1/2	1 3/4	1	1.5100	1.5032	1.7505	1.7495	1.5000	1.4990
MSI-2428-24	1 1/2	1 3/4	1 1/2	1.5100	1.5032	1.7505	1.7495	1.5000	1.4990
MSI-2428-40	1 1/2	1 3/4	2 1/2	1.5100	1.5032	1.7505	1.7495	1.5000	1.4990
MSI-2630-16	1 5/8	1 7/8	1	1.6350	1.6282	1.8755	1.8745	1.6250	1.6240
MSI-2832-08	1 3/4	2	1/2	1.7594	1.7531	2.0005	1.9995	1.7500	1.7490
MSI-2832-12	1 3/4	2	3/4	1.7594	1.7531	2.0005	1.9995	1.7500	1.7490
MSI-2832-16	1 3/4	2	1	1.7594	1.7531	2.0005	1.9995	1.7500	1.7490
MSI-2832-24	1 3/4	2	1 1/2	1.7594	1.7531	2.0005	1.9995	1.7500	1.7490
MSI-2832-40	1 3/4	2	2 1/2	1.7594	1.7531	2.0005	1.9995	1.7500	1.7490
MSI-3236-16	2	2 1/4	1	2.0100	2.0032	2.2505	2.2495	2.0000	1.9990
MSI-3236-24	2	2 1/4	1 1/2	2.0100	2.0032	2.2505	2.2495	2.0000	1.9990
MSI-3236-32	2	2 1/4	2	2.0100	2.0032	2.2505	2.2495	2.0000	1.9990
MSI-3236-40	2	2 1/4	2 1/2	2.0100	2.0032	2.2505	2.2495	2.0000	1.9990
MSI-4852-16	3	3 1/4	1	3.0114	3.0039	3.2505	3.2495	3.0000	2.9990

PDF: www.igus.com/iglide-pdfs
 CAD: www.igus.com/iglide-CAD
 RoHS info: www.igus.com/RoHS

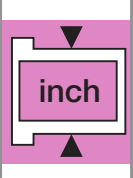

M250



iglide® Plain Bearings M250 - Flange Bearing, Inch

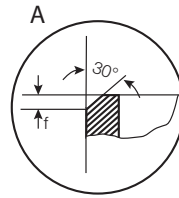

$r = \text{max. } .0197$

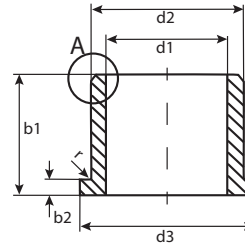

For tolerance values please refer to page 2.4

iglide® M250
Flange - Inch

Telephone 1-800-521-2747
Fax 1-401-438-7270

Internet: <http://www.igus.com>
email: sales@igus.com
QuickSpec: <http://www.igus.com/iglide-quickspec>

Part Number	d1	d2	b1	d3	b2	I.D. After Pressfit		Housing Bore		Shaft Size	
						Max.	Min.	Max.	Min.	Max.	Min.
MFI-0203-02	1/8	3/16	1/8	.3125	.032	.1280	.1262	.1885	.1880	.1250	.1241
MFI-0203-04	1/8	3/16	1/4	.3125	.032	.1280	.1262	.1885	.1880	.1250	.1241
MFI-0204-02	1/8	1/4	1/8	.360	.047	.1280	.1262	.2515	.2510	.1250	.1241
MFI-0204-03	1/8	1/4	3/16	.360	.047	.1280	.1262	.2515	.2510	.1250	.1241
MFI-0204-04	1/8	1/4	1/4	.360	.047	.1280	.1262	.2515	.2510	.1250	.1241
MFI-0204-06	1/8	1/4	3/8	.360	.047	.1280	.1262	.2515	.2510	.1250	.1241
MFI-0204-12	1/8	1/4	3/4	.360	.047	.1280	.1262	.2515	.2510	.1250	.1241
MFI-0304-04	3/16	1/4	1/4	.375	.032	.1905	.1887	.2515	.2510	.1875	.1866
MFI-0304-06	3/16	1/4	3/8	.375	.032	.1905	.1887	.2515	.2510	.1875	.1866
MFI-0304-08	3/16	1/4	1/2	.375	.032	.1905	.1887	.2515	.2510	.1875	.1866
MFI-0305-03	3/16	5/16	3/16	.370	.047	.1905	.1887	.3140	.3135	.1875	.1866
MFI-0305-04	3/16	5/16	1/4	.370	.047	.1905	.1887	.3140	.3135	.1875	.1866
MFI-0305-05	3/16	5/16	5/16	.370	.047	.1905	.1887	.3140	.3135	.1875	.1866
MFI-0305-06	3/16	5/16	3/8	.370	.047	.1905	.1887	.3140	.3135	.1875	.1866
MFI-0305-08	3/16	5/16	1/2	.370	.047	.1905	.1887	.3140	.3135	.1875	.1866
MFI-0405-02	1/4	5/16	1/8	.4375	.032	.2539	.2516	.3140	.3135	.2500	.2491
MFI-0405-03	1/4	5/16	3/16	.4375	.032	.2539	.2516	.3140	.3135	.2500	.2491
MFI-0405-04	1/4	5/16	1/4	.4375	.032	.2539	.2516	.3140	.3135	.2500	.2491
MFI-0405-06	1/4	5/16	3/8	.4375	.032	.2539	.2516	.3140	.3135	.2500	.2491
MFI-0405-07	1/4	5/16	7/16	.4375	.032	.2539	.2516	.3140	.3135	.2500	.2491
MFI-0405-08	1/4	5/16	1/2	.4375	.032	.2539	.2516	.3140	.3135	.2500	.2491
MFI-0405-12	1/4	5/16	3/4	.4375	.032	.2539	.2516	.3140	.3135	.2500	.2491
MFI-0406-02	1/4	3/8	1/8	.560	.047	.2539	.2516	.3765	.3760	.2500	.2491
MFI-0406-03	1/4	3/8	3/16	.560	.047	.2539	.2516	.3765	.3760	.2500	.2491
MFI-0406-04	1/4	3/8	1/4	.560	.047	.2539	.2516	.3765	.3760	.2500	.2491
MFI-0406-05	1/4	3/8	5/16	.560	.047	.2539	.2516	.3765	.3760	.2500	.2491
MFI-0406-06	1/4	3/8	3/8	.560	.047	.2539	.2516	.3765	.3760	.2500	.2491
MFI-0406-08	1/4	3/8	1/2	.560	.047	.2539	.2516	.3765	.3760	.2500	.2491
MFI-0406-10	1/4	3/8	5/8	.560	.047	.2539	.2516	.3765	.3760	.2500	.2491
MFI-0406-12	1/4	3/8	3/4	.560	.047	.2539	.2516	.3765	.3760	.2500	.2491
MFI-0506-02	5/16	3/8	1/8	.500	.032	.3164	.3141	.3765	.3760	.3125	.3116
MFI-0506-04	5/16	3/8	1/4	.500	.032	.3164	.3141	.3765	.3760	.3125	.3116
MFI-0506-06	5/16	3/8	3/8	.500	.032	.3164	.3141	.3765	.3760	.3125	.3116
MFI-0506-08	5/16	3/8	1/2	.500	.032	.3164	.3141	.3765	.3760	.3125	.3116
MFI-0506-15	5/16	3/8	15/16	.500	.032	.3164	.3141	.3765	.3760	.3125	.3116
MFI-0507-03	5/16	7/16	3/16	.560	.062	.3164	.3141	.4390	.4385	.3125	.3116
MFI-0507-04	5/16	7/16	1/4	.560	.062	.3164	.3141	.4390	.4385	.3125	.3116
MFI-0507-05	5/16	7/16	5/16	.560	.062	.3164	.3141	.4390	.4385	.3125	.3116
MFI-0507-06	5/16	7/16	3/8	.560	.062	.3164	.3141	.4390	.4385	.3125	.3116
MFI-0507-08	5/16	7/16	1/2	.560	.062	.3164	.3141	.4390	.4385	.3125	.3116
MFI-0507-10	5/16	7/16	5/8	.560	.062	.3164	.3141	.4390	.4385	.3125	.3116
MFI-0507-12	5/16	7/16	3/4	.560	.062	.3164	.3141	.4390	.4385	.3125	.3116

iglide® Plain Bearings M250 - Flange Bearing, Inch

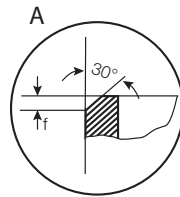

$r = \text{max. } .0197$

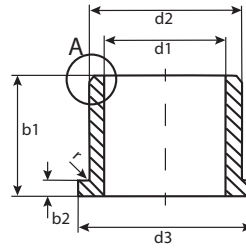

For tolerance values
please refer to page 2.4

iglide® M250
Flange - Inch

Part Number	d1	d2	b1	d3	b2	I.D. After Pressfit		Housing Bore		Shaft Size	
						Max.	Min.	Max.	Min.	Max.	Min.
MFI-0607-04	3/8	7/16	1/4	.5625	.032	.3789	.3766	.4390	.4385	.3750	.3741
MFI-0607-06	3/8	7/16	3/8	.5625	.032	.3789	.3766	.4390	.4385	.3750	.3741
MFI-0607-08	3/8	7/16	1/2	.5625	.032	.3789	.3766	.4390	.4385	.3750	.3741
MFI-0608-02	3/8	1/2	1/8	.625	.062	.3789	.3766	.5015	.5010	.3750	.3741
MFI-0608-03	3/8	1/2	3/16	.625	.062	.3789	.3766	.5015	.5010	.3750	.3741
MFI-0608-04	3/8	1/2	1/4	.625	.062	.3789	.3766	.5015	.5010	.3750	.3741
MFI-0608-05	3/8	1/2	5/16	.625	.062	.3789	.3766	.5015	.5010	.3750	.3741
MFI-0608-06	3/8	1/2	3/8	.625	.062	.3789	.3766	.5015	.5010	.3750	.3741
MFI-0608-08	3/8	1/2	1/2	.625	.062	.3789	.3766	.5015	.5010	.3750	.3741
MFI-0608-10	3/8	1/2	5/8	.625	.062	.3789	.3766	.5015	.5010	.3750	.3741
MFI-0608-12	3/8	1/2	3/4	.625	.062	.3789	.3766	.5015	.5010	.3750	.3741
MFI-0608-16	3/8	1/2	1	.625	.062	.3789	.3766	.5015	.5010	.3750	.3741
MFI-0608-17.5	3/8	1/2	1 3/32	.625	.062	.3789	.3766	.5015	.5010	.3750	.3741
MFI-0709-06	7/16	9/16	3/8	.687	.062	.4422	.4395	.5635	.5625	.4375	.4365
MFI-0709-08	7/16	9/16	1/2	.687	.062	.4422	.4395	.5635	.5625	.4375	.4365
MFI-0810-02	1/2	5/8	1/8	.875	.062	.5047	.5020	.6260	.6250	.5000	.4990
MFI-0810-04	1/2	5/8	1/4	.875	.062	.5047	.5020	.6260	.6250	.5000	.4990
MFI-0810-05	1/2	5/8	5/16	.875	.062	.5047	.5020	.6260	.6250	.5000	.4990
MFI-0810-06	1/2	5/8	3/8	.875	.062	.5047	.5020	.6260	.6250	.5000	.4990
MFI-0810-08	1/2	5/8	1/2	.875	.062	.5047	.5020	.6260	.6250	.5000	.4990
MFI-0810-10	1/2	5/8	5/8	.875	.062	.5047	.5020	.6260	.6250	.5000	.4990
MFI-0810-12	1/2	5/8	3/4	.875	.062	.5047	.5020	.6260	.6250	.5000	.4990
MFI-0810-16	1/2	5/8	1	.875	.062	.5047	.5020	.6260	.6250	.5000	.4990
MFI-1012-06	5/8	3/4	3/8	1.000	.062	.6297	.6270	.7510	.7500	.6250	.6240
MFI-1012-08	5/8	3/4	1/2	1.000	.062	.6297	.6270	.7510	.7500	.6250	.6240
MFI-1012-10	5/8	3/4	5/8	1.000	.062	.6297	.6270	.7510	.7500	.6250	.6240
MFI-1012-12	5/8	3/4	3/4	1.000	.062	.6297	.6270	.7510	.7500	.6250	.6240
MFI-1012-16	5/8	3/4	1	1.000	.062	.6297	.6270	.7510	.7500	.6250	.6240
MFI-1012-24	5/8	3/4	1 1/2	1.000	.062	.6297	.6270	.7510	.7500	.6250	.6240
MFI-1013-08	5/8	13/16	1/2	1.063	.156	.6297	.6270	.8135	.8125	.6250	.6240
MFI-1013-10	5/8	13/16	5/8	1.063	.156	.6297	.6270	.8135	.8125	.6250	.6240
MFI-1013-12	5/8	13/16	3/4	1.063	.156	.6297	.6270	.8135	.8125	.6250	.6240
MFI-1013-16	5/8	13/16	1	1.063	.156	.6297	.6270	.8135	.8125	.6250	.6240
MFI-1214-06	3/4	7/8	3/8	1.125	.062	.7559	.7525	.8760	.8750	.7500	.7490
MFI-1214-08	3/4	7/8	1/2	1.125	.062	.7559	.7525	.8760	.8750	.7500	.7490
MFI-1214-12	3/4	7/8	3/4	1.125	.062	.7559	.7525	.8760	.8750	.7500	.7490
MFI-1214-16	3/4	7/8	1	1.125	.062	.7559	.7525	.8760	.8750	.7500	.7490
MFI-1214-24	3/4	7/8	1 1/2	1.125	.062	.7559	.7525	.8760	.8750	.7500	.7490
MFI-1216-08	3/4	1	1/2	1.250	.156	.7559	.7525	1.0010	1.0000	.7500	.7490
MFI-1216-10	3/4	1	5/8	1.250	.156	.7559	.7525	1.0010	1.0000	.7500	.7490
MFI-1216-12	3/4	1	3/4	1.250	.156	.7559	.7525	1.0010	1.0000	.7500	.7490
MFI-1216-16	3/4	1	1	1.250	.156	.7559	.7525	1.0010	1.0000	.7500	.7490

PDF: www.igus.com/iglide-pdfs
CAD: www.igus.com/iglide-CAD
RoHS info: www.igus.com/RoHS

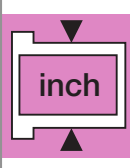
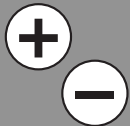

M250



iglide® Plain Bearings M250 - Flange Bearing, Inch

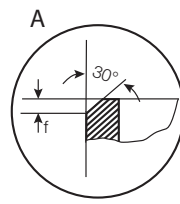

$r = \text{max. } .0197$

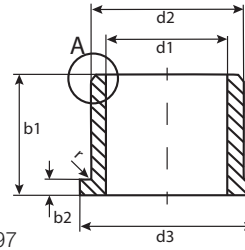

For tolerance values
please refer to page 2.4

iglide® M250
Flange - Inch

Telephone 1-800-521-2747
Fax 1-401-438-7270

Internet: <http://www.igus.com>
email: sales@igus.com
QuickSpec: <http://www.igus.com/iglide-quickspec>

Part Number	d1	d2	b1	d3	b2	I.D. After Pressfit		Housing Bore		Shaft Size	
						Max.	Min.	Max.	Min.	Max.	Min.
MFI-1216-24	3/4	1	1 1/2	1.250	.156	.7559	.7525	1.0010	1.0000	.7500	.7490
MFI-1216-32	3/4	1	2	1.250	.156	.7559	.7525	1.0010	1.0000	.7500	.7490
MFI-1416-12	7/8	1	3/4	1.250	.062	.8809	.8775	1.0010	1.0000	.8750	.8740
MFI-1416-16	7/8	1	1	1.250	.062	.8809	.8775	1.0010	1.0000	.8750	.8740
MFI-1416-24	7/8	1	1 1/2	1.250	.062	.8809	.8775	1.0010	1.0000	.8750	.8740
MFI-1418-08	7/8	1 1/8	1/2	1.375	.156	.8809	.8775	1.1260	1.1250	.8750	.8740
MFI-1418-12	7/8	1 1/8	3/4	1.375	.156	.8809	.8775	1.1260	1.1250	.8750	.8740
MFI-1418-16	7/8	1 1/8	1	1.375	.156	.8809	.8775	1.1260	1.1250	.8750	.8740
MFI-1418-24	7/8	1 1/8	1 1/2	1.375	.156	.8809	.8775	1.1260	1.1250	.8750	.8740
MFI-1618-03	1	1 1/8	3/16	1.375	.062	1.0059	1.0025	1.1260	1.1250	1.0000	.9990
MFI-1618-12	1	1 1/8	3/4	1.375	.062	1.0059	1.0025	1.1260	1.1250	1.0000	.9990
MFI-1618-16	1	1 1/8	1	1.375	.062	1.0059	1.0025	1.1260	1.1250	1.0000	.9990
MFI-1618-24	1	1 1/8	1 1/2	1.375	.062	1.0059	1.0025	1.1260	1.1250	1.0000	.9990
MFI-1620-08	1	1 1/4	1/2	1.500	.188	1.0059	1.0025	1.2510	1.2500	1.0000	.9990
MFI-1620-10	1	1 1/4	5/8	1.500	.188	1.0059	1.0025	1.2510	1.2500	1.0000	.9990
MFI-1620-12	1	1 1/4	3/4	1.500	.188	1.0059	1.0025	1.2510	1.2500	1.0000	.9990
MFI-1620-16	1	1 1/4	1	1.500	.188	1.0059	1.0025	1.2510	1.2500	1.0000	.9990
MFI-1620-24	1	1 1/4	1 1/2	1.500	.188	1.0059	1.0025	1.2510	1.2500	1.0000	.9990
MFI-2024-07	1 1/4	1 1/2	7/16	1.750	.200	1.2600	1.2531	1.5005	1.4995	1.2500	1.2490
MFI-2024-12	1 1/4	1 1/2	3/4	1.750	.200	1.2600	1.2531	1.5005	1.4995	1.2500	1.2490
MFI-2024-16	1 1/4	1 1/2	1	1.750	.200	1.2600	1.2531	1.5005	1.4995	1.2500	1.2490
MFI-2024-24	1 1/4	1 1/2	1 1/2	1.750	.200	1.2600	1.2531	1.5005	1.4995	1.2500	1.2490
MFI-2226-12	1 3/8	1 5/8	3/4	1.875	.125	1.3781	1.3759	1.6255	1.6245	1.3750	1.3740
MFI-2226-16	1 3/8	1 5/8	1	1.875	.125	1.3781	1.3759	1.6255	1.6245	1.3750	1.3740
MFI-2428-12	1 1/2	1 3/4	3/4	2.000	.125	1.5100	1.5032	1.7505	1.7495	1.5000	1.4990
MFI-2428-16	1 1/2	1 3/4	1	2.000	.125	1.5100	1.5032	1.7505	1.7495	1.5000	1.4990
MFI-2428-24	1 1/2	1 3/4	1 1/2	2.000	.125	1.5100	1.5032	1.7505	1.7495	1.5000	1.4990
MFI-2630-16	1 5/8	1 7/8	1	2.125	.125	1.6350	1.6282	1.8755	1.8745	1.6250	1.6240
MFI-2832-12	1 3/4	2	3/4	2.250	.125	1.7595	1.7531	2.0005	1.9995	1.7500	1.7490
MFI-2832-16	1 3/4	2	1	2.250	.125	1.7595	1.7531	2.0005	1.9995	1.7500	1.7490
MFI-2832-24	1 3/4	2	1 1/2	2.250	.125	1.7595	1.7531	2.0005	1.9995	1.7500	1.7490
MFI-3236-16	2	2 1/4	1	2.500	.125	2.0100	2.0032	2.2500	2.2512	2.0000	1.9990
MFI-3236-24	2	2 1/4	1 1/2	2.500	.125	2.0100	2.0032	2.2500	2.2512	2.0000	1.9990
MFI-3236-32	2	2 1/4	2	2.500	.125	2.0100	2.0032	2.2500	2.2512	2.0000	1.9990

iglide® Plain Bearings
M250 - Thrust Washer, Inch

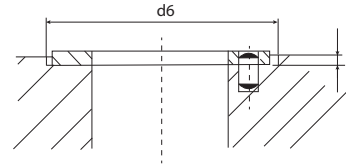
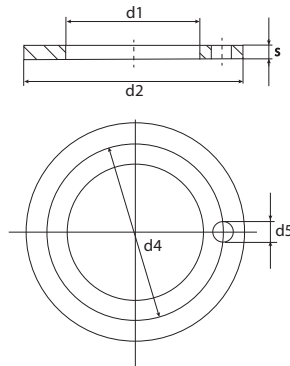

Part Number	d1(nominal)	d1		d2		s
		Max.	Min.	Max.	Min.	
MTI-04	1/4	.2609	.2550	.6200	.6094	.0900
MTI-05	5/16	.3271	.3189	.6874	.6767	.0900
MTI-06	3/8	.3850	.3780	.7409	.7394	.0900
MTI-08	1/2	.5101	.5030	.8200	.8070	.0900
MTI-10	5/8	.6371	.6300	1.0000	.9870	.0940
MTI-12	3/4	.7675	.7600	1.0630	1.0500	.0940
MTI-16	1	1.0200	1.0100	1.5000	1.4843	.1250
MTI-20	1 1/4	1.2998	1.2900	2.1400	2.1220	.0980
MTI-24	1 1/2	1.6000	1.5500	2.6000	2.5500	.1250

iglide® M250
Thrust Washer - Inch

PDF: www.igus.com/iglide-pdfs
CAD: www.igus.com/iglide-CAD
RoHS info: www.igus.com/RoHS

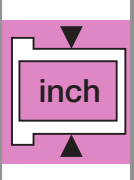

M250

iglus®

iglide® Plain Bearings

M250 - Sleeve Bearing - MM

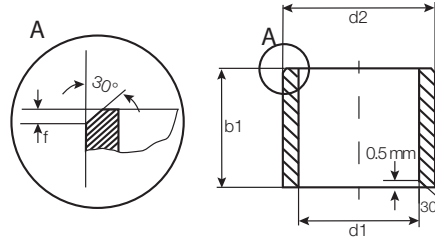

For tolerance values
please refer to page 2.4

Dimensions according to ISO 3547-1 and special dimensions

Part Number	d1		d2	b1	I.D. After Pressfit		Housing Bore		Shaft Size	
	After Pressfit in Ø H7				h13	Max.	Min.	Max.	Min.	Max.
MSM-0103-02	1.0	+0.020 +0.080	3.0	2.0	1.080	1.020	3.080	3.000	1.000	.975
MSM-0104-02	1.5	+0.020 +0.080	4.0	2.0	1.580	1.520	4.012	4.000	1.500	1.475
MSM-0205-01	2.0	+0.020 +0.080	5.0	1.0	2.080	2.020	5.012	5.000	2.000	1.975
MSM-0205-02	2.0	+0.020 +0.080	5.0	2.0	2.080	2.020	5.012	5.000	2.000	1.975
MSM-0205-03	2.0	+0.020 +0.080	5.0	3.0	2.080	2.020	5.012	5.000	2.000	1.975
MSM-0206-03	2.5	+0.020 +0.080	6.0	3.0	2.580	2.520	6.012	6.000	2.500	2.475
MSM-0305-03	3.0	+0.020 +0.080	5.0	3.0	3.080	3.020	5.012	5.000	3.000	2.975
MSM-0305-04	3.0	+0.020 +0.080	5.0	4.0	3.080	3.020	5.012	5.000	3.000	2.975
MSM-0306-03	3.0	+0.020 +0.080	6.0	3.0	3.080	3.020	6.012	6.000	3.000	2.975
MSM-0306-04	3.0	+0.020 +0.080	6.0	4.0	3.080	3.020	6.012	6.000	3.000	2.975
MSM-0407-03	4.0	+0.030 +0.105	7.0	3.0	4.105	4.030	7.015	7.000	4.000	3.970
MSM-0407-04	4.0	+0.030 +0.105	7.0	4.0	4.105	4.030	7.015	7.000	4.000	3.970
MSM-0407-06	4.0	+0.030 +0.105	7.0	6.0	4.105	4.030	7.015	7.000	4.000	3.970
MSM-0408-04	4.0	+0.030 +0.105	8.0	4.0	4.105	4.030	8.015	8.000	4.000	3.970
MSM-0408-06	4.0	+0.030 +0.105	8.0	6.0	4.105	4.030	8.015	8.000	4.000	3.970
MSM-0508-04	5.0	+0.030 +0.105	8.0	4.0	5.105	5.030	8.015	8.000	5.000	4.970
MSM-0508-05	5.0	+0.030 +0.105	8.0	5.0	5.105	5.030	8.015	8.000	5.000	4.970
MSM-0508-08	5.0	+0.030 +0.105	8.0	8.0	5.105	5.030	8.015	8.000	5.000	4.970
MSM-0509-05	5.0	+0.030 +0.105	9.0	5.0	5.105	5.030	9.015	9.000	5.000	4.970
MSM-0509-08	5.0	+0.030 +0.105	9.0	8.0	5.105	5.030	9.015	9.000	5.000	4.970
MSM-0608-10	6.0	+0.030 +0.105	8.0	10.0	6.105	6.030	8.015	8.000	6.000	5.970
MSM-0609-06	6.0	+0.030 +0.105	9.0	6.0	6.105	6.030	9.015	9.000	6.000	5.970
MSM-0610-02	6.0	+0.030 +0.105	10.0	2.0	6.105	6.030	10.015	10.000	6.000	5.970
MSM-0610-04	6.0	+0.030 +0.105	10.0	4.0	6.105	6.030	10.015	10.000	6.000	5.970
MSM-0610-06	6.0	+0.030 +0.105	10.0	6.0	6.105	6.030	10.015	10.000	6.000	5.970
MSM-0610-08	6.0	+0.030 +0.105	10.0	8.0	6.105	6.030	10.015	10.000	6.000	5.970
MSM-0610-10	6.0	+0.030 +0.105	10.0	10.0	6.105	6.030	10.015	10.000	6.000	5.970
MSM-0611-04	6.0	+0.030 +0.105	11.0	4.0	6.105	6.030	11.018	11.000	6.000	5.970
MSM-0612-06	6.0	+0.030 +0.105	12.0	6.0	6.105	6.030	12.018	12.000	6.000	5.970
MSM-0612-10	6.0	+0.030 +0.105	12.0	10.0	6.105	6.030	12.018	12.000	6.000	5.970
MSM-0710-05	7.0	+0.040 +0.130	10.0	5.0	7.130	7.040	10.015	10.000	7.000	6.964
MSM-0710-08	7.0	+0.040 +0.130	10.0	8.0	7.130	7.040	10.015	10.000	7.000	6.964
MSM-0710-10	7.0	+0.040 +0.130	10.0	10.0	7.130	7.040	10.015	10.000	7.000	6.964
MSM-0711-16	7.0	+0.040 +0.130	11.0	16.0	7.130	7.040	11.018	11.000	7.000	6.964
MSM-0810-06	8.0	+0.040 +0.130	10.0	6.0	8.130	8.040	10.015	10.000	8.000	7.964
MSM-0810-08	8.0	+0.040 +0.130	10.0	8.0	8.130	8.040	10.015	10.000	8.000	7.964
MSM-0810-10	8.0	+0.040 +0.130	10.0	10.0	8.130	8.040	10.015	10.000	8.000	7.964
MSM-0811-06	8.0	+0.040 +0.130	11.0	6.0	8.130	8.040	11.018	11.000	8.000	7.964
MSM-0811-08	8.0	+0.040 +0.130	11.0	8.0	8.130	8.040	11.018	11.000	8.000	7.964
MSM-0811-12	8.0	+0.040 +0.130	11.0	12.0	8.130	8.040	11.018	11.000	8.000	7.964
MSM-0812-04	8.0	+0.040 +0.130	12.0	4.0	8.130	8.040	12.018	12.000	8.000	7.964
MSM-0812-06	8.0	+0.040 +0.130	12.0	6.0	8.130	8.040	12.018	12.000	8.000	7.964

iglide® M250
Sleeve - MM

Telephone 1-800-521-2747
Fax 1-401-438-7270

Internet: <http://www.igus.com>
email: sales@igus.com
QuickSpec: <http://www.igus.com/iglide-quickspec>

iglide® Plain Bearings M250 - Sleeve Bearing - MM

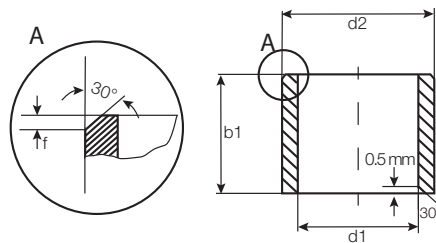
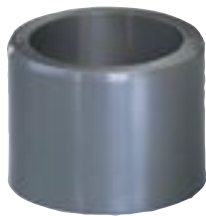

For tolerance values
please refer to page 2.4

Dimensions according to ISO 3547-1 and special dimensions

Part Number	d1		d2	b1	I.D. After Pressfit		Housing Bore		Shaft Size	
	After Pressfit in Ø H7				h13	Max.	Min.	Max.	Min.	Max.
MSM-0812-08	8.0	+0.040 +0.130	12.0	8.0	8.130	8.040	12.018	12.000	8.000	7.964
MSM-0812-10	8.0	+0.040 +0.130	12.0	10.0	8.130	8.040	12.018	12.000	8.000	7.964
MSM-0812-12	8.0	+0.040 +0.130	12.0	12.0	8.130	8.040	12.018	12.000	8.000	7.964
MSM-0814-06	8.0	+0.040 +0.130	14.0	6.0	8.130	8.040	14.018	14.000	8.000	7.964
MSM-0814-10	8.0	+0.040 +0.130	14.0	10.0	8.130	8.040	14.018	14.000	8.000	7.964
MSM-0912-14	9.0	+0.040 +0.130	12.0	14.0	9.130	9.040	12.018	12.000	9.000	8.964
MSM-1014-06	10.0	+0.040 +0.130	14.0	6.0	10.130	10.040	14.018	14.000	10.000	9.964
MSM-1014-08	10.0	+0.040 +0.130	14.0	8.0	10.130	10.040	14.018	14.000	10.000	9.964
MSM-1014-10	10.0	+0.040 +0.130	14.0	10.0	10.130	10.040	14.018	14.000	10.000	9.964
MSM-1014-16	10.0	+0.040 +0.130	14.0	16.0	10.130	10.040	14.018	14.000	10.000	9.964
MSM-1016-06	10.0	+0.040 +0.130	16.0	6.0	10.130	10.040	16.018	16.000	10.000	9.964
MSM-1016-08	10.0	+0.040 +0.130	16.0	8.0	10.130	10.040	16.018	16.000	10.000	9.964
MSM-1016-10	10.0	+0.040 +0.130	16.0	10.0	10.130	10.040	16.018	16.000	10.000	9.964
MSM-1016-16	10.0	+0.040 +0.130	16.0	16.0	10.130	10.040	16.018	16.000	10.000	9.964
MSM-1016-50	10.0	+0.040 +0.130	16.0	50.0	10.130	10.040	16.018	16.000	10.000	9.964
MSM-1214-15	12.0	+0.050 +0.160	14.0	15.0	12.160	12.050	14.018	14.000	12.000	11.957
MSM-1214-20	12.0	+0.050 +0.160	14.0	20.0	12.160	12.050	14.018	14.000	12.000	11.957
MSM-1216-15	12.0	+0.050 +0.160	16.0	15.0	12.160	12.050	16.018	16.000	12.000	11.957
MSM-1216-20	12.0	+0.050 +0.160	16.0	20.0	12.160	12.050	16.018	16.000	12.000	11.957
MSM-1218-08	12.0	+0.050 +0.160	18.0	8.0	12.160	12.050	18.018	18.000	12.000	11.957
MSM-1218-10	12.0	+0.050 +0.160	18.0	10.0	12.160	12.050	18.018	18.000	12.000	11.957
MSM-1218-15	12.0	+0.050 +0.160	18.0	15.0	12.160	12.050	18.018	18.000	12.000	11.957
MSM-1218-20	12.0	+0.050 +0.160	18.0	20.0	12.160	12.050	18.018	18.000	12.000	11.957
MSM-1416-085	14.0	+0.050 +0.160	16.0	8.5	14.160	14.050	16.018	16.000	14.000	13.957
MSM-1416-10	14.0	+0.050 +0.160	16.0	10.0	14.160	14.050	16.018	16.000	14.000	13.957
MSM-1416-15	14.0	+0.050 +0.160	16.0	15.0	14.160	14.050	16.018	16.000	14.000	13.957
MSM-1416-20	14.0	+0.050 +0.160	16.0	20.0	14.160	14.050	16.018	16.000	14.000	13.957
MSM-1416-29	14.0	+0.050 +0.160	16.0	29.0	14.160	14.050	16.018	16.000	14.000	13.957
MSM-1418-20	14.0	+0.050 +0.160	18.0	20.0	14.160	14.050	18.018	18.000	14.000	13.957
MSM-1420-10	14.0	+0.050 +0.160	20.0	10.0	14.160	14.050	20.021	20.000	14.000	13.957
MSM-1420-15	14.0	+0.050 +0.160	20.0	15.0	14.160	14.050	20.021	20.000	14.000	13.957
MSM-1420-20	14.0	+0.050 +0.160	20.0	20.0	14.160	14.050	20.021	20.000	14.000	13.957
MSM-1517-10	15.0	+0.050 +0.160	17.0	10.0	15.160	15.050	17.018	17.000	15.000	14.957
MSM-1517-15	15.0	+0.050 +0.160	17.0	15.0	15.160	15.050	17.018	17.000	15.000	14.957
MSM-1521-10	15.0	+0.050 +0.160	21.0	10.0	15.160	15.050	21.021	21.000	15.000	14.957
MSM-1521-15	15.0	+0.050 +0.160	21.0	15.0	15.160	15.050	21.021	21.000	15.000	14.957
MSM-1521-20	15.0	+0.050 +0.160	21.0	20.0	15.160	15.050	21.021	21.000	15.000	14.957
MSM-1521-23	15.0	+0.050 +0.160	21.0	23.0	15.160	15.050	21.021	21.000	15.000	14.957
MSM-1618-12	16.0	+0.050 +0.160	18.0	12.0	16.160	16.050	18.018	18.000	16.000	15.957
MSM-1618-20	16.0	+0.050 +0.160	18.0	20.0	16.160	16.050	18.018	18.000	16.000	15.957
MSM-1620-20	16.0	+0.050 +0.160	20.0	20.0	16.160	16.050	20.021	20.000	16.000	15.957
MSM-1620-25	16.0	+0.050 +0.160	20.0	25.0	16.160	16.050	20.021	20.000	16.000	15.957

iglide® M250
Sleeve - MM

PDF: www.igus.com/iglide-pdfs
CAD: www.igus.com/iglide-CAD
RoHS info: www.igus.com/RoHS

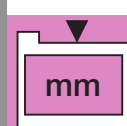
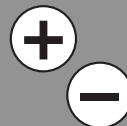

M250

iglus®

iglide® Plain Bearings

M250 - Sleeve Bearing - MM

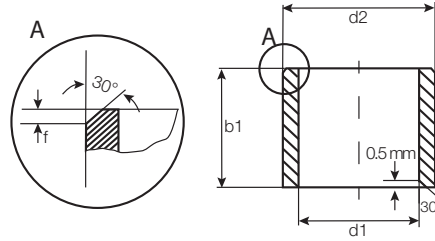

For tolerance values
please refer to page 2.4

Dimensions according to ISO 3547-1 and special dimensions

Part Number	d1		d2	b1	I.D. After Pressfit		Housing Bore		Shaft Size	
	After Pressfit in Ø H7				Max.	Min.	Max.	Min.	Max.	Min.
MSM-1620-30	16.0	+0.050 +0.160	20.0	30.0	16.160	16.050	20.021	20.000	16.000	15.957
MSM-1622-12	16.0	+0.050 +0.160	22.0	12.0	16.160	16.050	22.021	22.000	16.000	15.957
MSM-1622-15	16.0	+0.050 +0.160	22.0	15.0	16.160	16.050	22.021	22.000	16.000	15.957
MSM-1622-16	16.0	+0.050 +0.160	22.0	16.0	16.160	16.050	22.021	22.000	16.000	15.957
MSM-1622-20	16.0	+0.050 +0.160	22.0	20.0	16.160	16.050	22.021	22.000	16.000	15.957
MSM-1622-25	16.0	+0.050 +0.160	22.0	25.0	16.160	16.050	22.021	22.000	16.000	15.957
MSM-1824-12	18.0	+0.050 +0.160	24.0	12.0	18.160	18.050	24.021	24.000	18.000	17.957
MSM-1824-20	18.0	+0.050 +0.160	24.0	20.0	18.160	18.050	24.021	24.000	18.000	17.957
MSM-1824-30	18.0	+0.050 +0.160	24.0	30.0	18.160	18.050	24.021	24.000	18.000	17.957
MSM-2023-15	20.0	+0.065 +0.195	23.0	15.0	20.195	20.065	23.021	23.000	20.000	19.948
MSM-2023-20	20.0	+0.065 +0.195	23.0	20.0	20.195	20.065	23.021	23.000	20.000	19.948
MSM-2025-14	20.0	+0.065 +0.195	25.0	14.0	20.195	20.065	25.021	25.000	20.000	19.948
MSM-2025-20	20.0	+0.065 +0.195	25.0	20.0	20.195	20.065	25.021	25.000	20.000	19.948
MSM-2025-30	20.0	+0.065 +0.195	25.0	30.0	20.195	20.065	25.021	25.000	20.000	19.948
MSM-2026-12	20.0	+0.065 +0.195	26.0	12.0	20.195	20.065	26.021	26.000	20.000	19.948
MSM-2026-15	20.0	+0.065 +0.195	26.0	15.0	20.195	20.065	26.021	26.000	20.000	19.948
MSM-2026-20	20.0	+0.065 +0.195	26.0	20.0	20.195	20.065	26.021	26.000	20.000	19.948
MSM-2026-30	20.0	+0.065 +0.195	26.0	30.0	20.195	20.065	26.021	26.000	20.000	19.948
MSM-2226-15	22.0	+0.065 +0.195	26.0	15.0	22.195	22.065	26.021	26.000	22.000	21.948
MSM-2228-10	22.0	+0.065 +0.195	28.0	10.0	22.195	22.065	28.021	28.000	22.000	21.948
MSM-2228-15	22.0	+0.065 +0.195	28.0	15.0	22.195	22.065	28.021	28.000	22.000	21.948
MSM-2228-20	22.0	+0.065 +0.195	28.0	20.0	22.195	22.065	28.021	28.000	22.000	21.948
MSM-2228-30	22.0	+0.065 +0.195	28.0	30.0	22.195	22.065	28.021	28.000	22.000	21.948
MSM-2430-15	24.0	+0.065 +0.195	30.0	15.0	24.195	24.065	30.025	30.000	24.000	23.948
MSM-2430-20	24.0	+0.065 +0.195	30.0	20.0	24.195	24.065	30.025	30.000	24.000	23.948
MSM-2430-30	24.0	+0.065 +0.195	30.0	30.0	24.195	24.065	30.025	30.000	24.000	23.948
MSM-2528-12	25.0	+0.065 +0.195	28.0	12.0	25.195	25.065	28.021	28.000	25.000	24.948
MSM-2528-20	25.0	+0.065 +0.195	28.0	20.0	25.195	25.065	28.021	28.000	25.000	24.948
MSM-2530-20	25.0	+0.065 +0.195	30.0	20.0	25.195	25.065	30.025	30.000	25.000	24.948
MSM-2530-30	25.0	+0.065 +0.195	30.0	30.0	25.195	25.065	30.025	30.000	25.000	24.948
MSM-2530-40	25.0	+0.065 +0.195	30.0	40.0	25.195	25.065	30.025	30.000	25.000	24.948
MSM-2532-12	25.0	+0.065 +0.195	32.0	12.0	25.195	25.065	32.025	32.000	25.000	24.948
MSM-2532-20	25.0	+0.065 +0.195	32.0	20.0	25.195	25.065	32.025	32.000	25.000	24.948
MSM-2532-30	25.0	+0.065 +0.195	32.0	30.0	25.195	25.065	32.025	32.000	25.000	24.948
MSM-2532-35	25.0	+0.065 +0.195	32.0	35.0	25.195	25.065	32.025	32.000	25.000	24.948
MSM-2532-40	25.0	+0.065 +0.195	32.0	40.0	25.195	25.065	32.025	32.000	25.000	24.948
MSM-2630-20	26.0	+0.065 +0.195	30.0	20.0	26.195	26.065	30.025	30.000	26.000	25.948
MSM-2632-30	26.0	+0.065 +0.195	32.0	30.0	26.195	26.065	32.025	32.000	26.000	25.948
MSM-2734-20	27.0	+0.065 +0.195	34.0	20.0	27.195	27.065	34.025	34.000	27.000	26.948
MSM-2734-30	27.0	+0.065 +0.195	34.0	30.0	27.195	27.065	34.025	34.000	27.000	26.948

iglide® M250
Sleeve - MM

Telephone 1-800-521-2747
Fax 1-401-438-7270

Internet: <http://www.igus.com>
email: sales@igus.com
QuickSpec: <http://www.igus.com/iglide-quickspec>

iglide® Plain Bearings M250 - Sleeve Bearing - MM

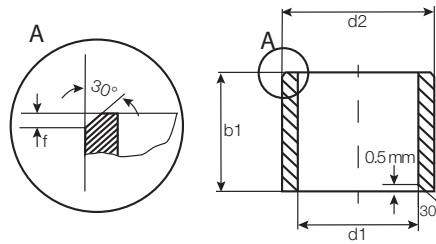

For tolerance values
please refer to page 2.4

Dimensions according to ISO 3547-1 and special dimensions

Part Number	d1		d2	b1	I.D. After Pressfit		Housing Bore		Shaft Size	
	After Pressfit	Tolerance in Ø H7			Max.	Min.	Max.	Min.	Max.	Min.
MSM-2734-40	27.0	+0.065 +0.195	34.0	40.0	27.195	27.065	34.025	34.000	27.000	26.948
MSM-2833-20	28.0	+0.065 +0.195	33.0	20.0	28.195	28.065	33.025	33.000	28.000	27.948
MSM-2836-20	28.0	+0.065 +0.195	36.0	20.0	28.195	28.065	36.025	36.000	28.000	27.948
MSM-2836-30	28.0	+0.065 +0.195	36.0	30.0	28.195	28.065	36.025	36.000	28.000	27.948
MSM-2836-40	28.0	+0.065 +0.195	36.0	40.0	28.195	28.065	36.025	36.000	28.000	27.948
MSM-3035-20	30.0	+0.065 +0.195	35.0	20.0	30.195	30.065	35.025	35.000	30.000	29.948
MSM-3035-40	30.0	+0.065 +0.195	35.0	40.0	30.195	30.065	35.025	35.000	30.000	29.948
MSM-3038-20	30.0	+0.065 +0.195	38.0	20.0	30.195	30.065	38.025	38.000	30.000	29.948
MSM-3038-30	30.0	+0.065 +0.195	38.0	30.0	30.195	30.065	38.025	38.000	30.000	29.948
MSM-3038-40	30.0	+0.065 +0.195	38.0	40.0	30.195	30.065	38.025	38.000	30.000	29.948
MSM-3040-40	30.0	+0.065 +0.195	40.0	40.0	30.195	30.065	40.025	40.000	30.000	29.948
MSM-3240-20	32.0	+0.080 +0.240	40.0	20.0	32.240	32.080	40.025	40.000	32.000	31.948
MSM-3240-30	32.0	+0.080 +0.240	40.0	30.0	32.240	32.080	40.025	40.000	32.000	31.948
MSM-3240-40	32.0	+0.080 +0.240	40.0	40.0	32.240	32.080	40.025	40.000	32.000	31.948
MSM-3542-50	35.0	+0.080 +0.240	42.0	50.0	35.240	35.080	42.025	42.000	35.000	34.948
MSM-7580-60	75.0	+0.100 +0.290	80.0	60.0	75.290	75.100	80.025	80.000	75.000	74.948

iglide® M250
Sleeve - MM

PDF: www.igus.com/iglide-pdfs
CAD: www.igus.com/iglide-CAD
RoHS info: www.igus.com/RoHS

M250



iglide® Plain Bearings M250 - Flange Bearing, MM

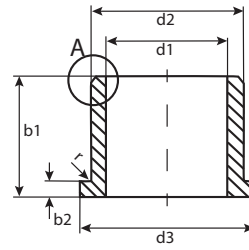
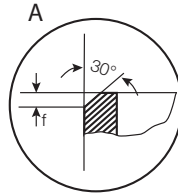

For tolerance values
please refer to page 2.4

r = max. 0.5

Dimensions according to ISO 3547-1 and special dimensions

Part Number	d1 ¹⁾		d2	d3	b1	b2	I.D. After Pressfit		Housing Bore		Shaft Size	
	After Pressfit in Ø H7						Max.	Min.	Max.	Min.	Max.	Min.
MFM-0103-02	1.0	+0.020 +0.080	3.0	5.0	2.0	1.00	1.080	1.020	3.080	3.000	1.000	.975
MFM-0104-02	1.5	+0.020 +0.080	4.0	6.0	2.0	1.00	1.580	1.520	4.012	4.000	1.500	1.475
MFM-0205-03	2.0	+0.020 +0.080	5.0	8.0	3.0	1.50	2.080	2.020	5.012	5.000	2.000	1.975
MFM-0206-03	2.5	+0.020 +0.080	6.0	9.0	3.0	1.50	2.580	2.520	6.012	6.000	2.500	2.475
MFM-0306-04	3.0	+0.020 +0.080	6.0	9.0	4.0	1.50	3.080	3.020	6.012	6.000	3.000	2.975
MFM-0408-04	4.0	+0.030 +0.105	8.0	12.0	4.0	2.0	4.105	4.030	8.015	8.000	4.000	3.970
MFM-0408-06	4.0	+0.030 +0.105	8.0	12.0	6.0	2.0	4.105	4.030	8.015	8.000	4.000	3.970
MFM-0408-08	4.0	+0.030 +0.105	8.0	12.0	8.0	2.0	4.105	4.030	8.015	8.000	4.000	3.970
MFM-0509-05	5.0	+0.030 +0.105	9.0	13.0	5.0	2.0	5.105	5.030	9.015	9.000	5.000	4.970
MFM-0509-06	5.0	+0.030 +0.105	9.0	13.0	6.0	2.0	5.105	5.030	9.015	9.000	5.000	4.970
MFM-0509-08	5.0	+0.030 +0.105	9.0	13.0	8.0	2.0	5.105	5.030	9.015	9.000	5.000	4.970
MFM-0610-04	6.0	+0.030 +0.105	10.0	14.0	4.0	2.0	6.105	6.030	10.015	10.000	6.000	5.970
MFM-0610-06	6.0	+0.030 +0.105	10.0	14.0	6.0	2.0	6.105	6.030	10.015	10.000	6.000	5.970
MFM-0610-10	6.0	+0.030 +0.105	10.0	14.0	10.0	2.0	6.105	6.030	10.015	10.000	6.000	5.970
MFM-0611-04	6.0	+0.030 +0.105	11.0	4.0	4.0	2.5	6.105	6.030	11.018	11.000	6.000	5.970
MFM-0612-06	6.0	+0.030 +0.105	12.0	14.0	6.0	3.0	6.105	6.030	12.018	12.000	6.000	5.970
MFM-0612-10	6.0	+0.030 +0.105	12.0	14.0	10.0	3.0	6.105	6.030	12.018	12.000	6.000	5.970
MFM-0711-08	7.0	+0.040 +0.130	11.0	15.0	8.0	2.0	7.130	7.040	11.018	11.000	7.000	6.964
MFM-0811-05	8.0	+0.040 +0.130	11.0	13.0	5.0	2.0	8.130	8.040	11.018	11.000	8.000	7.964
MFM-0811-08	8.0	+0.040 +0.130	11.0	13.0	8.0	2.0	8.130	8.040	11.018	11.000	8.000	7.964
MFM-0812-06	8.0	+0.040 +0.130	12.0	16.0	6.0	2.0	8.130	8.040	12.018	12.000	8.000	7.964
MFM-0812-08	8.0	+0.040 +0.130	12.0	16.0	8.0	2.0	8.130	8.040	12.018	12.000	8.000	7.964
MFM-0812-12	8.0	+0.040 +0.130	12.0	16.0	12.0	2.0	8.130	8.040	12.018	12.000	8.000	7.964
MFM-0814-06	8.0	+0.040 +0.130	14.0	18.0	6.0	3.0	8.130	8.040	14.018	14.000	8.000	7.964
MFM-0814-10	8.0	+0.040 +0.130	14.0	18.0	10.0	3.0	8.130	8.040	14.018	14.000	8.000	7.964
MFM-081416-06	8.0	+0.040 +0.130	14.0	16.0	6.0	3.0	8.130	8.040	14.018	14.000	8.000	7.964
MFM-081416-10	8.0	+0.040 +0.130	14.0	16.0	10.0	3.0	8.130	8.040	14.018	14.000	8.000	7.984
MFM-0914-06	9.0	+0.040 +0.130	14.0	19.0	6.0	2.0	9.130	9.040	14.018	14.000	9.000	8.964
MFM-0914-10	9.0	+0.040 +0.130	14.0	19.0	10.0	2.0	9.130	9.040	14.018	14.000	9.000	8.964
MFM-0914-14	9.0	+0.040 +0.130	14.0	19.0	14.0	2.0	9.130	9.040	14.018	14.000	9.000	8.964
MFM-1014-10	10.0	+0.040 +0.130	14.0	19.0	10.0	2.0	10.130	10.040	14.018	14.000	10.000	9.964
MFM-1014-14	10.0	+0.040 +0.130	14.0	17.5	14.0	1.0	10.130	10.040	14.018	14.000	10.000	9.964
MFM-1014-19	10.0	+0.040 +0.130	14.0	17.5	19.0	1.0	10.130	10.040	14.018	14.000	10.000	9.964
MFM-1014-24	10.0	+0.040 +0.130	14.0	17.5	24.0	1.0	10.130	10.040	14.018	14.000	10.000	9.964
MFM-1014-34	10.0	+0.040 +0.130	14.0	17.5	34.0	1.0	10.130	10.040	14.018	14.000	10.000	9.964
MFM-101420-12	10.0	+0.040 +0.130	14.0	20.0	12.0	2.0	10.130	10.040	14.018	14.000	10.000	9.964
MFM-1016-08	10.0	+0.040 +0.130	16.0	22.0	8.0	3.0	10.130	10.040	16.018	16.000	10.000	9.964
MFM-1016-10	10.0	+0.040 +0.130	16.0	22.0	10.0	3.0	10.130	10.040	16.018	16.000	10.000	9.964
MFM-1016-16	10.0	+0.040 +0.130	16.0	22.0	16.0	3.0	10.130	10.040	16.018	16.000	10.000	9.964
MFM-101620-06	10.0	+0.040 +0.130	16.0	20.0	6.0	3.0	10.130	10.040	16.018	16.000	10.000	9.964
MFM-101620-10	10.0	+0.040 +0.130	16.0	20.0	10.0	3.0	10.130	10.040	16.018	16.000	10.000	9.964
MFM-1216-10	12.0	+0.050 +0.160	16.0	22.0	10.0	2.0	12.160	12.050	16.018	16.000	12.000	11.957

iglide® M250
Flange - MM

Telephone 1-800-521-2747
Fax 1-401-438-7270

Internet: <http://www.igus.com>
email: sales@igus.com
QuickSpec: <http://www.igus.com/iglide-quickspec>

iglide® Plain Bearings M250 - Flange Bearing, MM



M250

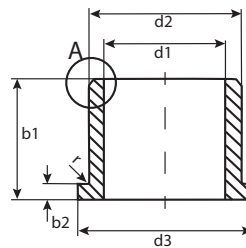
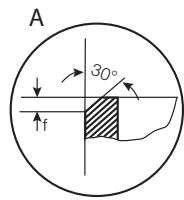

For tolerance values
please refer to page 2.4

$r = \max. 0.5$

Dimensions according to ISO 3547-1 and special dimensions

Part Number	d1 ¹⁾ After Pressfit in Ø H7	d1-Tolerance +0.050 +0.160	d2	d3 d13	b1 h13	b2 -0.14	I.D. After Pressfit		Housing Bore		Shaft Size	
							Max.	Min.	Max.	Min.	Max.	Min.
MFM-1216-20	12.0	+0.050 +0.160	16.0	22.0	20.0	2.0	12.160	12.050	16.018	16.000	12.000	11.957
MFM-1218-08	12.0	+0.050 +0.160	18.0	24.0	8.0	3.0	12.160	12.050	18.018	18.000	12.000	11.957
MFM-1218-10	12.0	+0.050 +0.160	18.0	22.0	10.0	3.0	12.160	12.050	18.018	18.000	12.000	11.957
MFM-1218-12	12.0	+0.050 +0.160	18.0	24.0	12.0	3.0	12.160	12.050	18.018	18.000	12.000	11.957
MFM-1218-15	12.0	+0.050 +0.160	18.0	22.0	15.0	3.0	12.160	12.050	18.018	18.000	12.000	11.957
MFM-1218-20	12.0	+0.050 +0.160	18.0	22.0	20.0	3.0	12.160	12.050	18.018	18.000	12.000	11.957
MFM-1420-07	14.0	+0.050 +0.160	20.0	25.0	7.0	3.0	14.160	14.050	20.021	20.000	14.000	13.957
MFM-1420-10	14.0	+0.050 +0.160	20.0	25.0	10.0	3.0	14.160	14.050	20.021	20.000	14.000	13.957
MFM-1420-15	14.0	+0.050 +0.160	20.0	25.0	15.0	3.0	14.160	14.050	20.021	20.000	14.000	13.957
MFM-1420-20	14.0	+0.050 +0.160	20.0	25.0	20.0	3.0	14.160	14.050	20.021	20.000	14.000	13.957
MFM-1521-10	15.0	+0.050 +0.160	21.0	27.0	10.0	3.0	15.160	15.050	21.021	21.000	15.000	14.957
MFM-1521-15	15.0	+0.050 +0.160	21.0	27.0	15.0	3.0	15.160	15.050	21.021	21.000	15.000	14.957
MFM-1521-20	15.0	+0.050 +0.160	21.0	27.0	20.0	3.0	15.160	15.050	21.021	21.000	15.000	14.957
MFM-1521-25	15.0	+0.050 +0.160	21.0	27.0	25.0	3.0	15.160	15.050	21.021	21.000	15.000	14.957
MFM-1618-12	16.0	+0.050 +0.160	18.0	24.0	12.0	1.0	16.160	16.050	18.021	18.000	16.000	15.957
MFM-1622-12	16.0	+0.050 +0.160	22.0	28.0	12.0	3.0	16.160	16.050	22.021	22.000	16.000	15.957
MFM-1622-15	16.0	+0.050 +0.160	22.0	28.0	15.0	3.0	16.160	16.050	22.021	22.000	16.000	15.957
MFM-1622-20	16.0	+0.050 +0.160	22.0	28.0	20.0	3.0	16.160	16.050	22.021	22.000	16.000	15.957
MFM-1622-25	16.0	+0.050 +0.160	22.0	28.0	25.0	3.0	16.160	16.050	22.021	22.000	16.000	15.957
MFM-1824-08	18.0	+0.050 +0.160	24.0	30.0	8.0	3.0	18.160	18.050	24.021	24.000	18.000	17.957
MFM-1824-12	18.0	+0.050 +0.160	24.0	30.0	12.0	3.0	18.160	18.050	24.021	24.000	18.000	17.957
MFM-1824-18	18.0	+0.050 +0.160	24.0	30.0	18.0	3.0	18.160	18.050	24.021	24.000	18.000	17.957
MFM-1824-20	18.0	+0.050 +0.160	24.0	30.0	20.0	3.0	18.160	18.050	24.021	24.000	18.000	17.957
MFM-1824-30	18.0	+0.050 +0.160	24.0	30.0	30.0	3.0	18.160	18.050	24.021	24.000	18.000	17.957
MFM-202628-12	20.0	+0.060 +0.195	26.0	28.0	12.0	3.0	20.195	20.065	26.021	26.000	20.000	19.948
MFM-2026-15	20.0	+0.060 +0.195	26.0	32.0	15.0	3.0	20.195	20.065	26.021	26.000	20.000	19.948
MFM-2026-20	20.0	+0.060 +0.195	26.0	32.0	20.0	3.0	20.195	20.065	26.021	26.000	20.000	19.948
MFM-2026-30	20.0	+0.060 +0.195	26.0	32.0	30.0	3.0	20.195	20.065	26.021	26.000	20.000	19.948
MFM-2228-15	22.0	+0.060 +0.195	28.0	34.0	15.0	3.0	22.195	22.065	28.021	28.000	22.000	21.948
MFM-2228-20	22.0	+0.060 +0.195	28.0	34.0	20.0	3.0	22.195	22.065	28.021	28.000	22.000	21.948
MFM-2228-30	22.0	+0.060 +0.195	28.0	34.0	30.0	3.0	22.195	22.065	28.021	28.000	22.000	21.948
MFM-2430-15	24.0	+0.065 +0.195	30.0	36.0	15.0	3.0	24.195	24.065	30.025	30.000	24.000	23.948
MFM-2430-20	24.0	+0.065 +0.195	30.0	36.0	20.0	3.0	24.195	24.065	30.025	30.000	24.000	23.948
MFM-2430-30	24.0	+0.065 +0.195	30.0	36.0	30.0	3.0	24.195	24.065	30.025	30.000	24.000	23.948
MFM-2532-12	25.0	+0.065 +0.195	32.0	38.0	12.0	4.0	25.195	25.065	32.025	32.000	25.000	24.948
MFM-2532-15	25.0	+0.065 +0.195	32.0	38.0	15.0	4.0	25.195	25.065	32.025	32.000	25.000	24.948
MFM-2532-20	25.0	+0.065 +0.195	32.0	38.0	20.0	4.0	25.195	25.065	32.025	32.000	25.000	24.948
MFM-2532-30	25.0	+0.065 +0.195	32.0	38.0	30.0	4.0	25.195	25.065	32.025	32.000	25.000	24.948
MFM-2532-40	25.0	+0.065 +0.195	32.0	38.0	40.0	4.0	25.195	25.065	32.025	32.000	25.000	24.948
MFM-2734-20	27.0	+0.065 +0.195	34.0	40.0	20.0	4.0	27.195	27.065	34.025	34.000	27.000	26.948
MFM-2734-30	27.0	+0.065 +0.195	34.0	40.0	30.0	4.0	27.195	27.065	34.025	34.000	27.000	26.948

iglide® M250
Flange - MM

PDF: www.igus.com/iglide-pdfs
CAD: www.igus.com/iglide-CAD
RoHS info: www.igus.com/RoHS

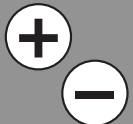

M250



iglide® Plain Bearings M250 - Flange Bearing, MM

iglide® M250
Flange - MM

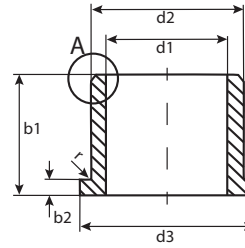
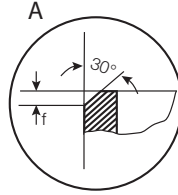

For tolerance values
please refer to page 2.4

r = max. 0.5

Dimensions according to ISO 3547-1 and special dimensions

Part Number	d1 ¹⁾		d2	d3	b1	b2	I.D. After Pressfit		Housing Bore		Shaft Size	
	After Pressfit in Ø H7						Max.	Min.	Max.	Min.	Max.	Min.
MFM-2734-40	27.0	+0.065 +0.195	34.0	40.0	40.0	4.0	27.195	27.065	34.025	34.000	27.000	26.948
MFM-2836-20	28.0	+0.065 +0.195	36.0	42.0	20.0	4.0	28.195	28.065	36.025	36.000	28.000	27.948
MFM-2836-30	28.0	+0.065 +0.195	36.0	42.0	30.0	4.0	28.195	28.065	36.025	36.000	28.000	27.948
MFM-2836-40	28.0	+0.065 +0.195	36.0	42.0	40.0	4.0	28.195	28.065	36.025	36.000	28.000	27.948
MFM-3035-20	30.0	+0.065 +0.195	35.0	44.0	20.0	4.0	30.195	30.060	35.025	35.000	30.000	29.948
MFM-3038-20	30.0	+0.065 +0.195	38.0	44.0	20.0	4.0	30.195	30.065	38.025	38.000	30.000	29.948
MFM-3038-30	30.0	+0.065 +0.195	38.0	44.0	30.0	4.0	30.195	30.065	38.025	38.000	30.000	29.948
MFM-3038-40	30.0	+0.065 +0.195	38.0	44.0	40.0	4.0	30.195	30.065	38.025	38.000	30.000	29.948
MFM-3240-20	32.0	+0.080 +0.240	40.0	46.0	20.0	4.0	32.240	32.080	40.025	40.000	32.000	31.938
MFM-3240-30	32.0	+0.080 +0.240	40.0	46.0	30.0	4.0	32.240	32.080	40.025	40.000	32.000	31.938
MFM-3240-40	32.0	+0.080 +0.240	40.0	46.0	40.0	4.0	32.240	32.080	40.025	40.000	32.000	31.938

Telephone 1-800-521-2747
Fax 1-401-438-7270

Internet: <http://www.igus.com>
email: sales@igus.com
QuickSpec: <http://www.igus.com/iglide-quickspec>

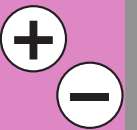



iglide® Plain Bearings M250 - Notes

iglide® M250

Telephone 1-800-521-2747
Fax 1-401-438-7270

Internet: <http://www.igus.com>
email: sales@igus.com
QuickSpec: <http://www.igus.com/iglide-quickspec>

igus[®]



iglide[®] R



iglide® Plain Bearings

R - Technical Data

Product Range

- Standard Styles: Sleeve, Flange and Thrust Washer
- Custom shapes and sizes available
- Inner diameters: Inch Sizes from 3/16 - 2 in. Metric sizes from 6 - 20 mm

Part Number Structure

Part Number Structure

R S I-02 03-03

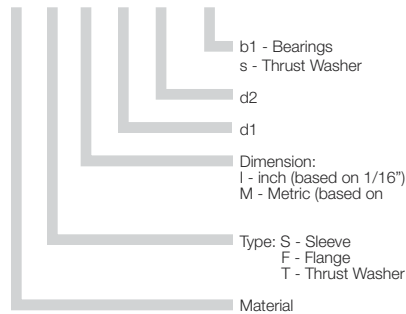

Permissible Surface Speeds

	Continuous fpm	Short Term fpm
Rotating	157	236
Oscillating	118	196
Linear	689	984

Usage Guidelines



- If high wear resistance at low load is required
- If low friction at dry operation is needed
- If a highly cost-effective bearing is desired
- If edge loads occur
- If you are looking for low water absorption
- If PTFE and silicone are prohibited in the application



- When high pressure loads occur
➤ iglide® G300
- When temperatures occur that are constantly greater than 194°F
➤ iglide® T500
- When best wear resistance is required
➤ iglide® J



Visit www.igus.com to use our online expert system

Material Table

General Properties	Unit	iglide® R	Testing Method
Density	g/cm ³	1.39	
Color		Dark Red	
Max. moisture absorption at 73°F / 50% r.h.	% weight	0.2	DIN 53495
Max. moisture absorption	% weight	1.1	
Coefficient of friction, dynamic against steel	μ	0.08 - 0.26	
p x v value, max. (dry)	psi x fpm		

Mechanical Properties

Modulus of elasticity	psi	290,000	DIN 53457
Tensile strength at 68°F	psi	10,150	DIN 53452
Compressive strength	psi	9,860	
Permissible static surface pressure (68°F)	psi	3,335	
Shore D-hardness		77	DIN 53505

Physical and Thermal Properties

Max. long-term application temperature	°F	194	
Max. application temperature, short-term	°F	230	
Min. application temperature	°F	-58	
Thermal conductivity	W/m x K	.25	ASTM C 177
Coefficient of thermal expansion	K ⁻¹ x 10 ⁻⁵	11	DIN 53752

Electrical Properties

Specific volume resistance	Ωcm	> 10 ¹²	DIN IEC 93
Surface resistance	Ω	> 10 ¹²	DIN 53482

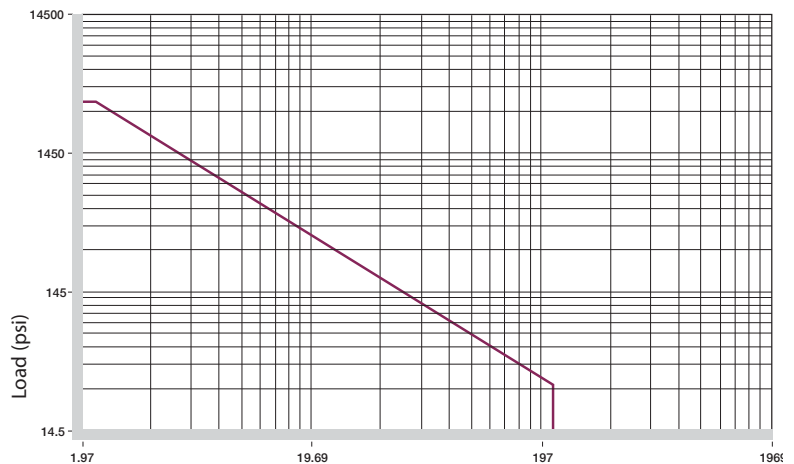

Graph 3.1: Permissible p x v value for iglide® R running dry against a steel shaft, at 68°F

In the development of iglide® R as a bearing material, high performance and a very low price were the top requirements. In particular, low coefficients of friction were needed at high speeds in the dry run. Plain bearings made of iglide® R are designed with support from a combination of solid lubricants. The iglide® R material achieves excellent low coefficients of friction while running dry, and it runs for the most part stick-slip free.

Compressive Strength

iglide® R plain bearings were developed mainly for low to average radial loads. The Graph 3.2 shows the elastic deformation of iglide® R for radial loads. At the maximum permissible load of 3335 psi, the deformation is approximately 3%. Plastic deformation is not detectable up to this value. However, it is also a result of the cycle time.

➤ Compressive Strength, Page 1.3

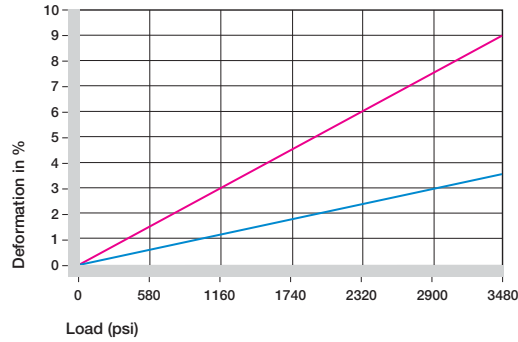

Graph 3.2: Deformation under load and temperature

Permissible Surface Speeds

iglide® R plain bearings are used at high surface speeds. For linear movements, short-term speeds up to 32.8 ft/s are permissible. Please note that the given maximum values can only be achieved at the lowest pressure loads. These values show the speed at which friction causes a temperature increase to the continued use temperature limit.

➤ Surface Speed, Page 1.5
➤ p x v value, Page 1.6

	Continuous fpm	Short Term fpm
Rotating	157	236
Oscillating	118	196
Linear	689	984

Table 3.2: Maximum surface speeds

Temperatures

The maximum permissible short-term temperature is 230°F, and the long-term application temperature is 194°F. With increasing temperatures, the compression resistance of iglide® R plain bearings decreases. Graph 3.3 shows this relationship. The ambient temperatures prevalent in the bearing system also have an effect on the bearing wear. With increasing temperatures, the wear increases.

➤ Application Temperatures, Page 1.7

iglide® R	Application Temperature
Minimum	- 58°F
Max. long-term	+ 194°F
Max. short-term	+ 230°F

Table 3.3: Temperature limits for iglide® R

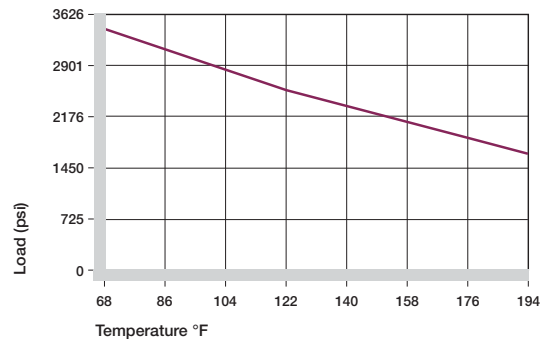

Graph 3.3: Recommended maximum permissible static surface pressure of iglide® R as a result of the temperature

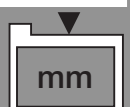



iglide® Plain Bearings R - Technical Data

iglide® R

Telephone 1-800-521-2747
1-401-438-7270
Fax

Internet: <http://www.igus.com>
email: sales@igus.com
QuickSpec: <http://www.igus.com/iglide-quickspec>

Installation Tolerances

iglide® R plain bearings are oversized before being pressfit. After proper installation into a recommended housing bore, the inner diameter adjusts to meet our specified tolerances. Please adhere to the catalog specifications for housing bore and recommended shaft sizes. This will help to ensure optimal performance of iglide® plain bearings.

- See Tolerance Table, Page 1.14
- Testing Methods, Page 1.15

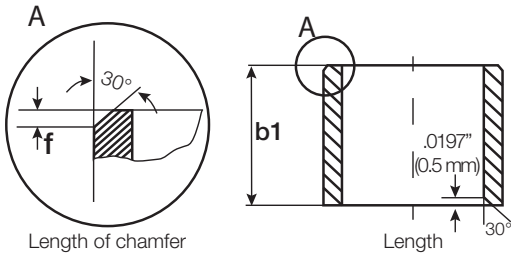

For Inch Size Bearings		
Length Tolerance (b1)	Length of Chamfer (f)	
Length (inches)	Tolerance (h13) (inches)	Based on d1
0.1181 to 0.2362	-0.0000 /-0.0071	f = .012 → d ₁ .040" - .236"
0.2362 to 0.3937	-0.0000 /-0.0087	f = .019 → d ₁ > .236" - .472"
0.3937 to 0.7086	-0.0000 /-0.0106	f = .031 → d ₁ > .472" - 1.18"
0.7086 to 1.1811	-0.0000 /-0.0130	f = .047 → d ₁ > 1.18"
1.1811 to 1.9685	-0.0000 /-0.0154	
1.9685 to 3.1496	-0.0000 /-0.0181	

For Metric Size Bearings		
Length Tolerance (b1)	Length of Chamfer (f)	
Length (mm)	Tolerance (h13) (µm)	Based on d1
1 to 3	-0 /-140	f = 0.3 → d ₁ 1 - 6 mm
> 3 to 6	-0 /-180	f = 0.5 → d ₁ > 6 - 12 mm
> 6 to 10	-0 /-220	f = 0.8 → d ₁ > 12 - 30 mm
> 10 to 18	-0 /-270	f = 1.2 → d ₁ > 30 mm
> 18 to 30	-0 /-330	
> 30 to 50	-0 /-390	
> 50 to 80	-0 /-460	

Friction and Wear

Similar to wear resistance, the coefficient of friction decreases with increasing load. In contrast, higher speeds have little effect on the coefficient of friction of iglide® R plain bearings. iglide® R is especially suited for applications in which high p x v values are predominantly caused by the high speed, and not as much by the surface pressure. The coefficient of friction of iglide® R plain bearings depends greatly on the shaft roughness. In the roughness range between 16-24 rms, the coefficient of friction reaches its optimal value. For values above and below this range, the friction of the bearing system increases quickly. Other shaft materials can be used without a large loss. Even with non metallic shafts, good results were obtained in tests. Ceramic and plastic shafts can also be used.

- Coefficients of Friction and Surfaces, Page 1.8
- Wear Resistance, Page 1.9

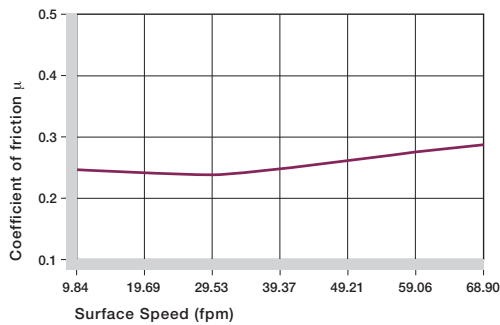

Graph 3.4: Coefficient of friction of iglide® R as a result of the surface speed; p = 108 psi

iglide® R	Coefficient of Friction
Dry	0.06 - 0.26
Grease	0.09
Oil	0.04
Water	0.04

Table 3.4: Coefficients of friction iglide® R against steel (Shaft finish = 40 rms, 50 HRC)

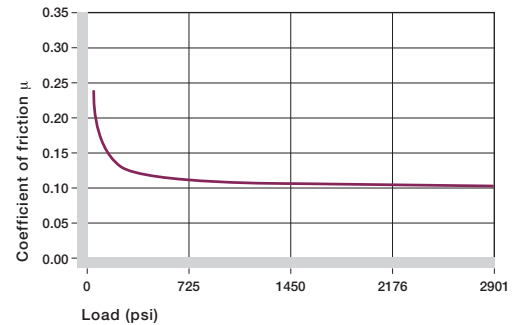

Graph 3.5: Coefficient of friction of iglide® R as a result of the load, v = 1.97 fpm

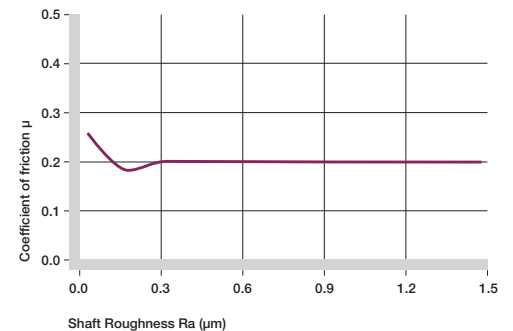

Graph 3.6: Coefficient of friction for iglide® R as a result of the shaft surface (shaft Cold Rolled Steel)

Shaft Materials

Graph 3.7 to 3.9 show results of testing different shaft materials with plain bearings made of iglide® R.

In the low load range, the 440B, hard anodized aluminum, 1050 case hardened steel, free cutting and hard chromed shafts are the most suitable shafting partners for iglide® R plain bearings. At higher loads, the hardened shafts such as 440B and 1050 case hardened steel are recommended.

➤ Shaft Materials, Page 1.11

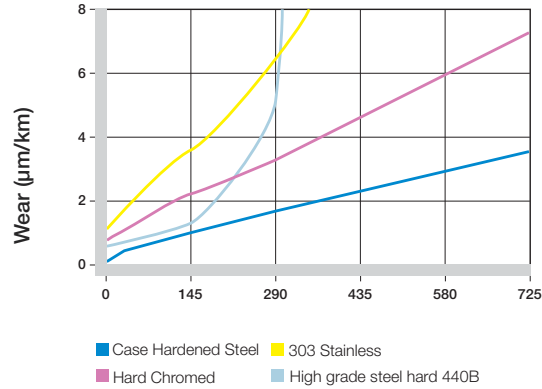

Graph 3.8: Wear of iglide® R with different shaft materials in rotational operation

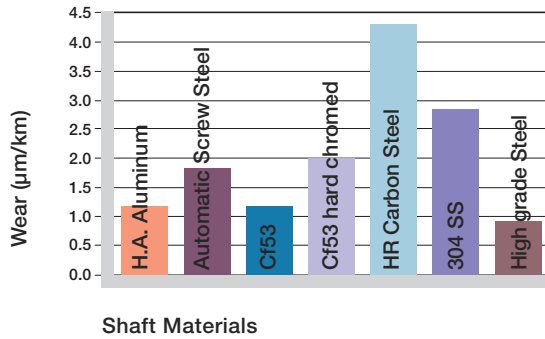

Graph 3.7: Wear for iglide® R, rotating with different shaft materials, p = 108 psi, v = 98 fpm

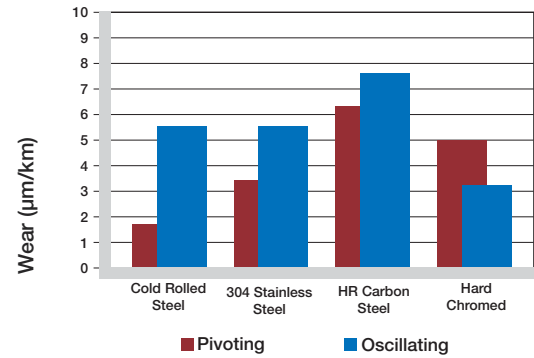

Graph 3.9: Wear for oscillating and rotating applications with different shaft materials at p = 290 psi

Chemical & Moisture Resistance

iglide® R plain bearings are resistant to very weak acids, diluted lyes, fuels and all types of lubricants.

The moisture absorption of iglide® R plain bearings is approximately 0.2% in standard atmosphere. The saturation limit in water is 1%. This low moisture absorption allows for design in wet environments.

➤ Chemical Table, Page 1.16

Medium	Resistance
Alcohol	+ to 0
Hydrocarbon, chlorinated	+
Greases, oils without additives	+
Fuels	+
Weak acids	0 to -
Strong acids	-
Weak alkaline	+
Strong alkaline	+ to 0

+ resistant, 0 conditionally resistant, - not resistant

Table 3.5: Chemical resistance of iglide® R

All data given concerns the chemical resistance at room temperature (68°F). For a complete list, see page 1.16

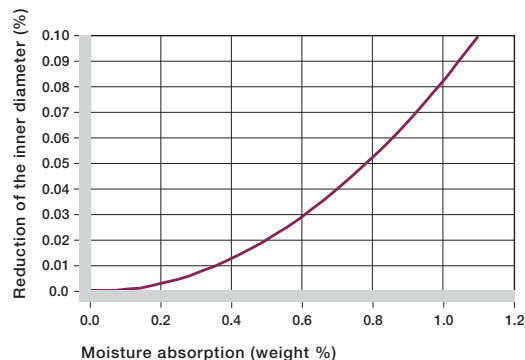

Graph 3.10: Effect of moisture absorption on iglide® R plain bearings

PDF: www.igus.com/iglide-pdfs
CAD: www.igus.com/iglide-CAD
RoHS info: www.igus.com/RoHS

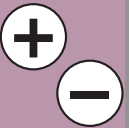



iglide® R

Telephone 1-800-521-2747
Fax 1-401-438-7270

Internet: <http://www.igus.com>
email: sales@igus.com
QuickSpec: <http://www.igus.com/iglide-quickspec>

Radiation Resistance

Plain bearings made from iglide® R are resistant to radiation up to an intensity of 3×10^2 Gy.

UV Resistance

iglide® R plain bearings are resistant to UV radiation, but the tribological properties are lessened with permanent exposure.

Vacuum

In a vacuum environment, iglide® R plain bearings release gases. It is only possible to use iglide® R in vacuum to a limited extent.

Electrical Properties

iglide® R plain bearings are electrically insulating

iglide® R

Specific volume resistance	> $10^{12} \Omega\text{cm}$
Surface resistance	> $10^{12} \Omega$

Table 3.6: Electrical properties of iglide® R

iglide® Plain Bearings

R - Sleeve Bearing, Inch

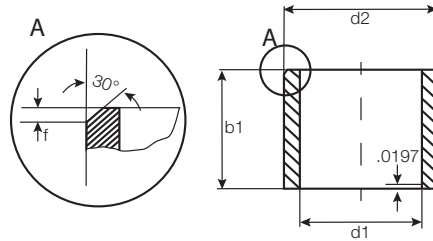

Part Number	d1	d2	b1	I.D. After Pressfit		Housing Bore		Shaft Size	
				Max.	Min.	Max.	Min.	Max.	Min.
RSI-0305-03	3/16	5/16	3/16	1.915	.1886	.3128	.3122	.1874	.1862
RSI-0305-04	3/16	5/16	1/4	1.915	.1886	.3128	.3122	.1874	.1862
RSI-0305-06	3/16	5/16	3/8	1.915	.1886	.3128	.3122	.1874	.1862
RSI-0305-08	3/16	5/16	1/2	1.915	.1886	.3128	.3122	.1874	.1862
RSI-0406-04	1/4	3/8	1/4	.2551	.2516	.3766	.3760	.2500	.2486
RSI-0406-05	1/4	3/8	5/16	.2551	.2516	.3766	.3760	.2500	.2486
RSI-0406-06	1/4	3/8	3/8	.2551	.2516	.3766	.3760	.2500	.2486
RSI-0406-10	1/4	3/8	5/8	.2551	.2516	.3766	.3760	.2500	.2486
RSI-0406-12	1/4	3/8	3/4	.2551	.2516	.3766	.3760	.2500	.2486
RSI-0507-04	5/16	7/16	1/4	.3177	.3142	.4393	.4386	.3126	.3112
RSI-0507-05	5/16	7/16	5/16	.3177	.3142	.4393	.4386	.3126	.3112
RSI-0507-06	5/16	7/16	3/8	.3177	.3142	.4393	.4386	.3126	.3112
RSI-0507-08	5/16	7/16	1/2	.3177	.3142	.4393	.4386	.3126	.3112
RSI-0507-10	5/16	7/16	5/8	.3177	.3142	.4393	.4386	.3126	.3112
RSI-0507-12	5/16	7/16	3/4	.3177	.3142	.4393	.4386	.3126	.3112
RSI-0608-04	3/8	1/2	1/4	.3799	.3764	.5017	.5010	.3748	.3734
RSI-0608-06	3/8	1/2	3/8	.3799	.3764	.5017	.5010	.3748	.3734
RSI-0608-08	3/8	1/2	1/2	.3799	.3764	.5017	.5010	.3748	.3734
RSI-0608-10	3/8	1/2	5/8	.3799	.3764	.5017	.5010	.3748	.3734
RSI-0608-12	3/8	1/2	3/4	.3799	.3764	.5017	.5010	.3748	.3734
RSI-0608-16	3/8	1/2	1	.3799	.3764	.5017	.5010	.3748	.3734
RSI-0810-08	1/2	5/8	1/2	.5063	.5020	.6257	.6250	.5000	.4983
RSI-0810-10	1/2	5/8	5/8	.5063	.5020	.6257	.6250	.5000	.4983
RSI-0810-12	1/2	5/8	3/4	.5063	.5020	.6257	.6250	.5000	.4983
RSI-0810-16	1/2	5/8	1	.5063	.5020	.6257	.6250	.5000	.4983
RSI-1012-06	5/8	3/4	3/8	.6311	.6268	.7508	.7500	.6248	.6231
RSI-1012-08	5/8	3/4	1/2	.6311	.6268	.7508	.7500	.6248	.6231
RSI-1012-10	5/8	3/4	5/8	.6311	.6268	.7508	.7500	.6248	.6231
RSI-1012-12	5/8	3/4	3/4	.6311	.6268	.7508	.7500	.6248	.6231
RSI-1012-16	5/8	3/4	1	.6311	.6268	.7508	.7500	.6248	.6231
RSI-1214-06	3/4	7/8	3/8	.7577	.7526	.8756	.8748	.7500	.7480
RLCSI-1214-16	3/4	7/8	1	.7549	.7516	.8756	.8748	.7500	.7480
RSI-1216-12	3/4	1	3/4	.7577	.7526	1.0008	1.0000	.7500	.7480
RSI-1216-16	3/4	1	1	.7577	.7526	1.0008	1.0000	.7500	.7480
RSI-1216-20	3/4	1	1 1/4	.7577	.7526	1.0008	1.0000	.7500	.7480
RSI-1216-24	3/4	1	1 1/2	.7577	.7526	1.0008	1.0000	.7500	.7480
RSI-1416-12	7/8	1	3/4	.8799	.8766	1.0008	1.0000	.8750	.8730
RSI-1416-16	7/8	1	1	.8799	.8766	1.0008	1.0000	.8750	.8730
RSI-1416-24	7/8	1	1 1/2	.8799	.8766	1.0008	1.0000	.8750	.8730

iglide® R
Sleeve - Inch

PDF: www.igus.com/iglide-pdfs
CAD: www.igus.com/iglide-CAD
RoHS info: www.igus.com/RoHS

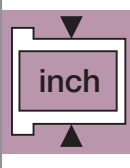
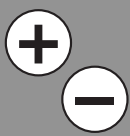



iglide® Plain Bearings R - Sleeve Bearing, Inch

iglide® R
Sleeve - Inch

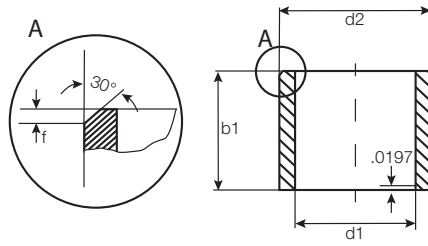

For tolerance values
please refer to page 3.4

Telephone 1-800-521-2747
Fax 1-401-438-7270

Part Number	d1	d2	b1	I.D. After Pressfit		Housing Bore		Shaft Size	
				Max.	Min.	Max.	Min.	Max.	Min.
RSI-1418-10	7/8	1 1/8	5/8	.8825	.8774	1.1295	1.1287	.8748	.8728
RSI-1418-12	7/8	1 1/8	3/4	.8825	.8774	1.1295	1.1287	.8748	.8728
RSI-1418-16	7/8	1 1/8	1	.8825	.8774	1.1295	1.1287	.8748	.8728
RSI-1418-24	7/8	1 1/8	1 1/2	.8825	.8774	1.1295	1.1287	.8748	.8728
RSI-1618-12	1	1 1/8	3/4	1.0077	1.0026	1.1295	1.1287	.8748	.8728
RSI-1618-22	1	1 1/8	1 3/8	1.0077	1.0026	1.1295	1.1287	.8748	.8728
RSI-1620-10	1	1 1/4	5/8	1.0077	1.0026	1.2510	1.2500	1.0000	.9980
RSI-1620-12	1	1 1/4	3/4	1.0077	1.0026	1.2510	1.2500	1.0000	.9980
RSI-1620-16	1	1 1/4	1	1.0077	1.0026	1.2510	1.2500	1.0000	.9980
RSI-1620-20	1	1 1/4	1 1/4	1.0077	1.0026	1.2510	1.2500	1.0000	.9980
RSI-1620-24	1	1 1/4	1 1/2	1.0077	1.0026	1.2510	1.2500	1.0000	.9980
RSI-2024-16	1 1/4	1 1/2	1	1.2594	1.2531	1.5010	1.5000	1.2500	1.2476
RSI-3236-16	2	2 1/4	1	2.0114	2.0039	2.2512	2.2500	2.0000	1.9971
RSI-3236-32	2	2 1/4	2	2.0114	2.0039	2.2512	2.2500	2.0000	1.9971

Part number RLCSI indicates a low clearance bearing

Internet: <http://www.igus.com>
email: sales@igus.com
QuickSpec: <http://www.igus.com/iglide-quickspec>

iglide® Plain Bearings R - Flange Bearing, Inch

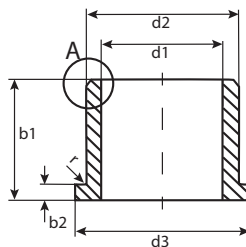
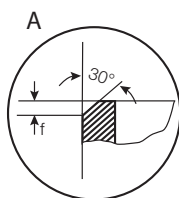

For tolerance values
please refer to page 3.4

$r = \max. .0197$

iglide® R
Flange - Inch

Part Number	d1	d2	b1	d3	b2	I.D. After Pressfit		Housing Bore		Shaft Size	
						Max.	Min.	Max.	Min.	Max.	Min.
RFI-0305-03	3/16	5/16	3/16	.370	.047	.1915	.1886	.3131	.3125	.1962	.1874
RFI-0305-04	3/16	5/16	1/4	.370	.047	.1915	.1886	.3131	.3125	.1962	.1874
RFI-0305-06	3/16	5/16	3/8	.370	.047	.1915	.1886	.3131	.3125	.1962	.1874
RFI-0305-08	3/16	5/16	1/2	.370	.047	.1915	.1886	.3131	.3125	.1962	.1874
RFI-0406-04	1/4	3/8	1/4	.560	.047	.2551	.2516	.3756	.3750	.2500	.2486
RFI-0406-05	1/4	3/8	5/16	.560	.047	.2551	.2516	.3756	.3750	.2500	.2486
RFI-0406-06	1/4	3/8	3/8	.560	.047	.2551	.2516	.3756	.3750	.2500	.2486
RFI-0406-08	1/4	3/8	1/2	.560	.047	.2551	.2516	.3756	.3750	.2500	.2486
RFI-0406-10	1/4	3/8	5/8	.560	.047	.2551	.2516	.3756	.3750	.2500	.2486
RFI-0406-12	1/4	3/8	3/4	.560	.047	.2551	.2516	.3756	.3750	.2500	.2486
RFI-0507-04	5/16	7/16	1/4	.560	.062	.3177	.3142	.4381	.4374	.31265	.3112
RFI-0507-05	5/16	7/16	5/16	.560	.062	.3177	.3142	.4381	.4374	.31265	.3112
RFI-0507-06	5/16	7/16	3/8	.560	.062	.3177	.3142	.4381	.4374	.31265	.3112
RFI-0507-08	5/16	7/16	1/2	.560	.062	.3177	.3142	.4381	.4374	.31265	.3112
RFI-0507-10	5/16	7/16	5/8	.560	.062	.3177	.3142	.4381	.4374	.31265	.3112
RFI-0507-12	5/16	7/16	3/4	.560	.062	.3177	.3142	.4381	.4374	.31265	.3112
RFI-0607-04	3/8	15/32	1/4	.687	.046	.3801	.3766	.4694	.4687	.3750	.3736
RFI-0608-04	3/8	1/2	1/4	.625	.062	.3801	.3766	.5017	.5010	.3750	.3741
RFI-0608-06	3/8	1/2	3/8	.625	.062	.3801	.3766	.5017	.5010	.3750	.3741
RFI-0608-08	3/8	1/2	1/2	.625	.062	.3801	.3766	.5017	.5010	.3750	.3741
RFI-0608-10	3/8	1/2	5/8	.625	.062	.3801	.3766	.5017	.5010	.3750	.3741
RFI-0608-12	3/8	1/2	3/4	.625	.062	.3801	.3766	.5017	.5010	.3750	.3741
RFI-0608-16	3/8	1/2	1	.625	.062	.3801	.3766	.5017	.5010	.3750	.3741
RFI-0708-04	7/16	1/2	1/4	.750	.046	.4429	.4386	.5319	.5312	.4366	.4349
RFI-0708-08	7/16	1/2	1/2	.750	.046	.4429	.4386	.5319	.5312	.4366	.4349
RFI-0809-03	1/2	19/32	3/16	.875	.046	.5063	.5020	.5944	.5937	.4990	.4980
RFI-0809-04	1/2	19/32	1/4	.875	.046	.5063	.5020	.5944	.5937	.4990	.4980
RFI-0809-08	1/2	19/32	1/2	.875	.046	.5063	.5020	.5944	.5937	.4990	.4980
RFI-0810-04	1/2	5/8	1/4	.875	.062	.5063	.5020	.6257	.6250	.5000	.4983
RFI-0810-06	1/2	5/8	3/8	.875	.062	.5063	.5020	.6257	.6250	.5000	.4983
RFI-0810-08	1/2	5/8	1/2	.875	.062	.5063	.5020	.6257	.6250	.5000	.4983
RFI-0810-10	1/2	5/8	5/8	.875	.062	.5063	.5020	.6257	.6250	.5000	.4983
RFI-0810-12	1/2	5/8	3/4	.875	.062	.5063	.5020	.6257	.6250	.5000	.4983
RFI-0810-16	1/2	5/8	1	.875	.062	.5063	.5020	.6257	.6250	.5000	.4983
RFI-0812-0210	1/2	3/4	7/32	1.000	.125	.5047	.5020	.7508	.7500	.5000	.4983
RFI-0812-08	1/2	3/4	1/2	1.000	.125	.5047	.5020	.7508	.7500	.5000	.4983
RFI-0812-12	1/2	3/4	3/4	1.000	.125	.5047	.5020	.7508	.7500	.5000	.4983
RFI-0812-16	1/2	3/4	1	1.000	.125	.5047	.5020	.7508	.7500	.5000	.4983

PDF: www.igus.com/iglide-pdfs
 CAD: www.igus.com/iglide-CAD
 RoHS info: www.igus.com/RoHS

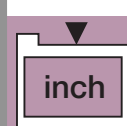



iglide® Plain Bearings R - Flange Bearing, Inch

iglide® R
Flange - Inch

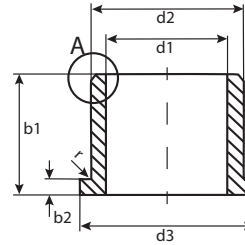
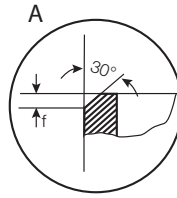

For tolerance values
please refer to page 3.4

r = max. .0197

Telephone 1-800-521-2747
Fax 1-401-438-7270

Internet: <http://www.igus.com>
email: sales@igus.com
QuickSpec: <http://www.igus.com/iglide-quickspec>

Part Number	d1	d2	b1	d3	b2	I.D. After Pressfit		Housing Bore		Shaft Size	
						Max.	Min.	Max.	Min.	Max.	Min.
RFI-1012-06	5/8	3/4	3/8	1.000	.062	.6313	.6270	.7508	.7500	.6250	.6233
RFI-1012-08	5/8	3/4	1/2	1.000	.062	.6313	.6270	.7508	.7500	.6250	.6233
RFI-1012-10	5/8	3/4	5/8	1.000	.062	.6313	.6270	.7508	.7500	.6250	.6233
RFI-1012-12	5/8	3/4	3/4	1.000	.062	.6313	.6270	.7508	.7500	.6250	.6233
RFI-1012-16	5/8	3/4	1	1.000	.062	.6313	.6270	.7508	.7500	.6250	.6233
RLCFI-1214-07	3/4	7/8	7/16	1.125	.062	.7549	.7516	.8756	.8748	.7500	.7480
RLCFI-1214-08	3/4	7/8	7/16	1.125	.062	.7549	.7516	.8756	.8748	.7500	.7480
RLCFI-1214-12	3/4	7/8	7/16	1.125	.062	.7549	.7516	.8756	.8748	.7500	.7480
RLCFI-1214-16	3/4	7/8	7/16	1.125	.062	.7549	.7516	.8756	.8748	.7500	.7480
RFI-1216-08	3/4	1	1/2	1.250	.156	.7577	.7526	1.0008	1.0000	.7500	.7480
RFI-1216-12	3/4	1	3/4	1.250	.156	.7577	.7526	1.0008	1.0000	.7500	.7480
RFI-1216-16	3/4	1	1	1.250	.156	.7577	.7526	1.0008	1.0000	.7500	.7480
RFI-1216-20	3/4	1	1 1/4	1.250	.156	.7577	.7526	1.0008	1.0000	.7500	.7480
RFI-1216-24	3/4	1	1 1/2	1.250	.156	.7577	.7526	1.0008	1.0000	.7500	.7480
RLCFI-1416-07	7/8	1	7/16	1.250	.062	.8789	.8756	1.0005	.9997	.8740	.8720
RLCFI-1416-12	7/8	1	7/16	1.250	.062	.8789	.8756	1.0005	.9997	.8740	.8720
RLCFI-1416-20	7/8	1	7/16	1.250	.062	.8789	.8756	1.0005	.9997	.8740	.8720
RFI-1418-10	7/8	1 1/8	5/8	1.375	.156	.8825	.8774	1.1258	1.1250	.8748	.8728
RFI-1418-12	7/8	1 1/8	3/4	1.375	.156	.8825	.8774	1.1258	1.1250	.8748	.8728
RFI-1418-16	7/8	1 1/8	1	1.375	.156	.8825	.8774	1.1258	1.1250	.8748	.8728
RFI-1418-24	7/8	1 1/8	1 1/2	1.375	.156	.8825	.8774	1.1258	1.1250	.8748	.8728
RFI-1618-08	1	1 1/8	1/2	1.375	.062	1.0077	1.0026	1.1258	1.1250	1.0000	.9980
RFI-1618-12	1	1 1/8	3/4	1.375	.062	1.0077	1.0026	1.1258	1.1250	1.0000	.9980
RFI-1618-20	1	1 1/8	1 1/4	1.375	.062	1.0077	1.0026	1.1258	1.1250	1.0000	.9980
RFI-1620-10	1	1 1/4	5/8	1.500	.188	1.0077	1.0026	1.2510	1.2500	1.0000	.9980
RFI-1620-12	1	1 1/4	3/4	1.500	.188	1.0077	1.0026	1.2510	1.2500	1.0000	.9980
RFI-1620-16	1	1 1/4	1	1.500	.188	1.0077	1.0026	1.2510	1.2500	1.0000	.9980
RFI-1620-20	1	1 1/4	1 1/4	1.500	.188	1.0077	1.0026	1.2510	1.2500	1.0000	.9980
RFI-1620-24	1	1 1/4	1 1/2	1.500	.188	1.0077	1.0026	1.2510	1.2500	1.0000	.9980
RLCFI-2022-09	1 1/4	1 13/32	9/16	1.687	.078	1.2547	1.2508	1.4108	1.4098	1.2488	1.2464
RFI-2024-16	1 1/4	1 1/2	1	1.750	.200	1.2594	1.2531	1.5049	1.5039	1.2500	1.2476
RFI-2428-12	1 1/2	1 3/4	3/4	2.000	.125	1.5094	1.5031	1.7585	1.7575	1.5000	1.4976
RFI-3236-12	2	2 1/4	3/4	2.500	.125	2.0114	2.0039	2.2591	2.2579	2.0000	1.9971
RFI-3236-24	2	2 1/4	1 1/2	2.500	.125	2.0114	2.0039	2.2591	2.2579	2.0000	1.9971
RFI-3236-32	2	2 1/4	2	2.500	.125	2.0114	2.0039	2.2591	2.2579	2.0000	1.9971

Part number RLCFI indicates a low clearance bearing

iglide® Plain Bearings

R - Low Clearance Flange Bearing, Inch

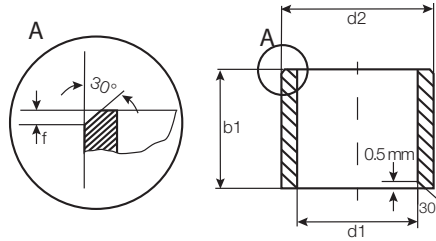

For tolerance values please refer to page 3.4

Dimensions according to ISO 3547-1 and special dimensions

Part Number	d1	d1-Tolerance After Pressfit in Ø H7	d2	b1 h13	I.D. After Pressfit		Housing Bore		Shaft Size	
					Max.	Min.	Max.	Min.	Max.	Min.
RSM-0506-05	5.0	+0.020 +0.068	6.0	5.0	5.068	5.020	6.012	6.000	5.000	4.970
RSM-0506-07	5.0	+0.020 +0.068	6.0	7.0	5.068	5.020	6.012	6.000	5.000	4.970
RSM-0608-06	6.0	+0.020 +0.068	8.0	6.0	6.068	6.020	8.015	8.000	6.000	5.970
RSM-0610-08	6.0	+0.020 +0.068	10.0	8.0	6.068	6.020	10.015	10.000	6.000	5.970
RSM-0810-10	8.0	+0.025 +0.083	10.0	10.0	8.083	8.025	10.015	10.000	8.000	7.964
RSM-1012-05	10.0	+0.025 +0.083	12.0	5.0	10.083	10.025	12.018	12.000	10.000	9.964
RSM-1012-10	10.0	+0.025 +0.083	12.0	10.0	10.083	10.025	12.018	12.000	10.000	9.964
RSM-1012-15	10.0	+0.025 +0.083	12.0	15.0	10.083	10.025	12.018	12.000	10.000	9.964
RSM-1214-12	12.0	+0.032 +0.102	14.0	12.0	12.102	12.032	14.018	14.000	12.000	11.957
RSM-1416-10	14.0	+0.032 +0.102	16.0	10.0	14.102	14.032	16.018	16.000	14.000	13.957
RSM-1416-15	14.0	+0.032 +0.102	16.0	15.0	14.102	14.032	16.018	16.000	14.000	13.957
RSM-1618-15	16.0	+0.032 +0.102	18.0	15.0	16.102	16.032	18.018	18.000	16.000	15.957
RSM-1820-25	18.0	+0.032 +0.102	20.0	25.0	18.102	18.032	20.021	20.000	18.000	17.957
RSM-2023-15	20.0	+0.040 +0.124	23.0	15.0	20.124	20.040	23.021	23.000	20.000	19.948
RSM-2023-20	20.0	+0.040 +0.124	23.0	20.0	20.124	20.040	23.021	23.000	20.000	19.948
RSM-3034-25	30.0	+0.040 +0.124	34.0	25.0	30.124	30.040	34.025	34.000	30.000	29.948

iglide® R
Flange - Inch

PDF: www.igus.com/iglide-pdfs
CAD: www.igus.com/iglide-CAD
RoHS info: www.igus.com/RoHS

iglide® Plain Bearings

R - Flange Bearing, MM

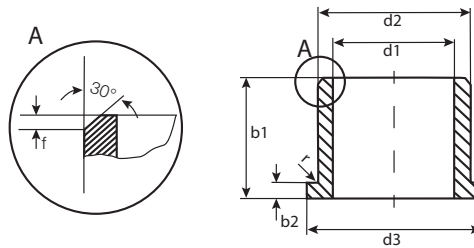

For tolerance values please refer to page 3.4

r = max. 0.5

Dimensions according to ISO 3547-1 and special dimensions

Part Number	d1 ¹⁾	d1-Tolerance After Pressfit in Ø H7	d2	b1 h13	d3	b2 -0.14	I.D. After Pressfit		Housing Bore		Shaft Size	
							Max.	Min.	Max.	Min.	Max.	Min.
RFM-0608-06	6.0	+0.020 +0.068	8.0	6.0	12.0	1.0	6.068	6.020	8.015	8.000	6.000	5.970
RFM-0810-05	8.0	+0.025 +0.083	10.0	5.0	15.0	1.0	8.083	8.025	10.015	10.000	8.000	7.964
RFM-0810-10	8.0	+0.025 +0.083	10.0	10.0	15.0	1.0	8.083	8.025	10.015	10.000	8.000	7.964
RFM-1012-09	10.0	+0.025 +0.083	12.0	9.0	18.0	1.0	10.083	10.025	12.018	12.000	10.000	9.964
RFM-1012-10	10.0	+0.025 +0.083	12.0	10.0	18.0	1.0	10.083	10.025	12.018	12.000	10.000	9.964
RFM-1012-18	10.0	+0.025 +0.083	12.0	18.0	18.0	1.0	10.083	10.025	12.018	12.000	10.000	9.964
RFM-1214-12	12.0	+0.032 +0.102	14.0	12.0	20.0	1.0	12.102	12.032	14.018	14.000	12.000	11.957
RFM-1416-17	14.0	+0.032 +0.102	16.0	17.0	22.0	1.0	14.102	14.032	16.018	16.000	14.000	13.957
RFM-1618-17	16.0	+0.032 +0.102	18.0	17.0	24.0	1.0	16.102	16.032	18.018	18.000	16.000	15.957
RFM-1622-12	16.0	+0.032 +0.102	22.0	12.0	24.0	3.0	16.102	16.032	22.021	22.000	16.000	15.957
RFM-2023-21	20.0	+0.040 +0.124	23.0	21.0	30.0	1.5	20.124	20.040	23.021	23.000	20.000	19.948

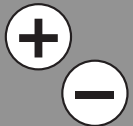

r = max. 0.5





iglide® Plain Bearings R - Notes

iglide® R

Telephone 1-800-521-2747
Fax 1-401-438-7270

Internet: <http://www.igus.com>
email: sales@igus.com
QuickSpec: <http://www.igus.com/iglide-quickspec>

igus[®]



iglide[®] J



Product Range

- Standard Styles:
Sleeve, Flange and Thrust Washer
- Custom shapes and sizes available
- Inner diameters:
Inch sizes from 1/8 - 1-5/8 in.
Metric sizes from 2.5 - 75 mm

Part Number Structure

Part Number Structure

J S I - 02 03 - 03

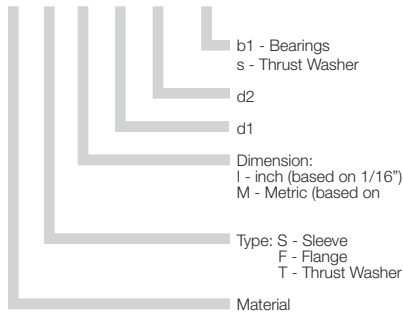

Permissible Surface Speeds

	Continuous fpm	Short Term fpm
Rotating	295	590
Oscillating	216	413
Linear	1574	1968

Usage Guidelines



- When very low coefficients of friction are necessary
- When a cost effective bearing for low pressure loads is needed
- For high speeds
- For high wear resistance



- When high pressure loads occur
➤ iglide® G300, iglide® L280
- When temperatures occur that are greater than 248°F for a short-term
➤ iglide® G300



Visit www.igus.com
to use our online
expert system

Material Table

General Properties	Unit	iglide® J	Testing Method
Density	g/cm ³	1.49	
Color		yellow	
Max. moisture absorption at 73°F/50% r.h.	% weight	0.3	DIN 53495
Max. moisture absorption	% weight	1.3	
Coefficient of friction, dynamic against steel	μ	0.06 - 0.18	
p x v value, max. (dry)	psi x fpm	9700	

Mechanical Properties

Modulus of elasticity	psi	348,000	DIN 53457
Tensile strength at 68°F	psi	10,585	DIN 53452
Compressive strength	psi	8,700	
Permissible static surface pressure (68°F)	psi	5,075	
Shore D-hardness		74	DIN 53505

Physical and Thermal Properties

Max. long-term application temperature	°F	194	
Max. application temperature, short-term	°F	248	
Min. application temperature	°F	-58	
Thermal conductivity	W/m x K	0.25	ASTM C 177
Coefficient of thermal expansion (at 73°F)	K ⁻¹ x 10 ⁻⁵	10	DIN 53752

Electrical Properties

Specific volume resistance	Ωcm	> 10 ¹³	DIN IEC 93
Surface resistance	Ω	> 10 ¹²	DIN 53482

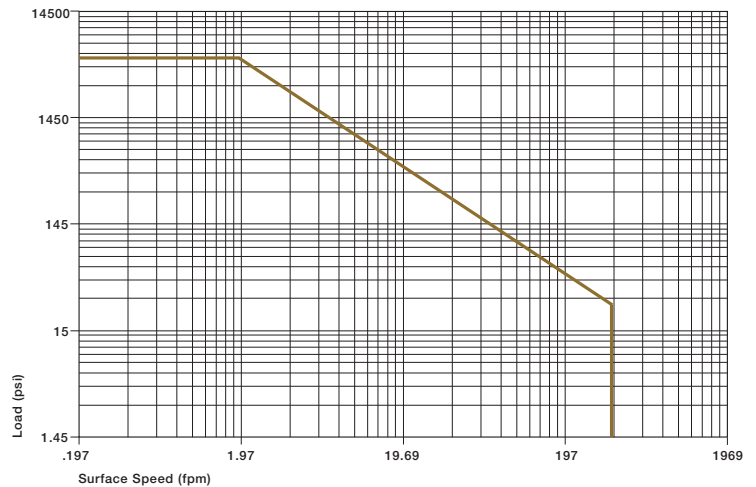

Graph 4.1: Permissible p x v value for iglide® J running dry against steel shaft, at 68°F



The iglide® J plain bearings are designed for the lowest coefficients of friction while running dry and their low stick-slip tendency.

Compressive Strength

With a maximum permissible surface pressure of 5075 psi, iglide® J plain bearings are not suited for extreme loads. Shown in Graph 4.2 is the elastic deformation of iglide® J for radial loads. At the maximum permissible load of 5075 psi, the deformation is less than 2.5%.

► Compressive Strength, Page 1.3

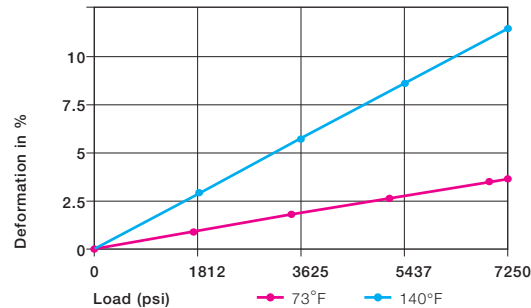

Graph 4.2: Deformation under load and temperature

Permissible Surface Speeds

The low coefficient of friction and the extremely low stick-slip tendency of iglide® J plain bearings are especially important at very low speeds. However, iglide® J material can also be used for high speeds of over 197 fpm. In both cases, the static friction is very low and stick-slip does not occur.

The maximum values given in Table 4.2 can only be achieved at the lowest pressure loads. At the given speeds, friction can cause a temperature increase to maximum permissible levels. In practice, though, this temperature level is rarely reached, due to varying application conditions.

► Surface Speed, Page 1.5
► $p \times v$ value, Page 1.6

	Continuous fpm	Short Term fpm
Rotating	295	590
Oscillating	216	413
Linear	1574	1968

Table 4.2: Maximum surface speeds

Temperatures

iglide® J plain bearings can be used between -58°F and 194°F; the short-term maximum permissible temperature is 248°F. Graph 4.3 shows that the compressive strength of iglide® J plain bearings decreases with increasing temperatures. Also, the wear increases significantly above 176°F

► Application Temperatures, Page 1.7

iglide® J	Application Temperature
Minimum	-58 °F
Max., long-term	+194 °F
Max., short-term	+248 °F

Table 4.3: Temperature limits for iglide® J

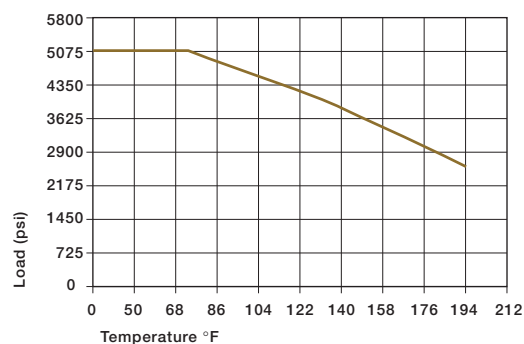

Graph 4.3: Recommended maximum permissible static surface pressure of iglide® J as a result of the temperature

iglide® J

PDF: www.igus.com/iglide-pdfs
CAD: www.igus.com/iglide-CAD
RoHS info: www.igus.com/RoHS

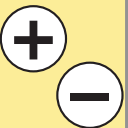



Installation Tolerances

iglide® J plain bearings are oversized before being pressfit. After proper installation into a recommended housing bore, the inner diameter adjusts to meet our specified tolerances. Please adhere to the catalog specifications for housing bore and recommended shaft sizes. This will help to ensure optimal performance of iglide® plain bearings.

- See Tolerance Table, Page 1.14
- Testing Methods, Page 1.15

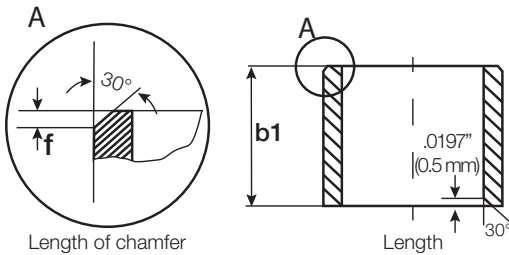

For Inch Size Bearings		
Length Tolerance (b1)		Length of Chamfer (f)
Length (inches)	Tolerance (h13) (inches)	Based on d1
0.1181 to 0.2362	-0.0000 /-0.0071	f = .012 → d ₁ .040" - .236"
0.2362 to 0.3937	-0.0000 /-0.0087	f = .019 → d ₁ > .236" - .472"
0.3937 to 0.7086	-0.0000 /-0.0106	f = .031 → d ₁ > .472" - 1.18"
0.7086 to 1.1811	-0.0000 /-0.0130	f = .047 → d ₁ > 1.18"
1.1811 to 1.9685	-0.0000 /-0.0154	
1.9685 to 3.1496	-0.0000 /-0.0181	

For Metric Size Bearings		
Length Tolerance (b1)		Length of Chamfer (f)
Length (mm)	Tolerance (h13) (µm)	Based on d1
1 to 3	-0 /-140	f = 0.3 → d ₁ 1 - 6 mm
> 3 to 6	-0 /-180	f = 0.5 → d ₁ > 6 - 12 mm
> 6 to 10	-0 /-220	f = 0.8 → d ₁ > 12 - 30 mm
> 10 to 18	-0 /-270	f = 1.2 → d ₁ > 30 mm
> 18 to 30	-0 /-330	
> 30 to 50	-0 /-390	
> 50 to 80	-0 /-460	

Friction and Wear

Graph 4.5 shows the coefficients of friction for different loads. The coefficient of friction level is very good for all loads with iglide® J. Friction and wear are also dependent, to a large extent, on the shafting partner. With increasing shaft roughness, the coefficient of friction also increases.

For iglide® J a ground surface with an average roughness range of 4 - 12 rms is recommended for the shaft.

- Coefficients of Friction and Surfaces, Page 1.8
- Wear Resistance, Page 1.9

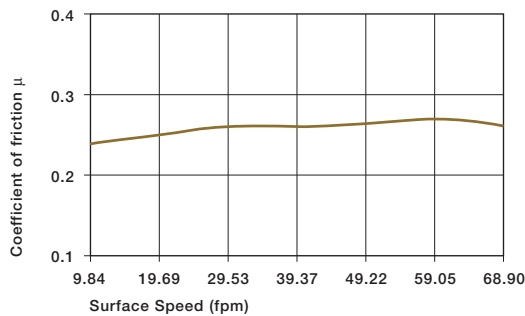

Graph 4.4: Coefficient of friction of iglide® J as a result of the surface speed; p = 108 psi

iglide® J	Coefficient of Friction
Dry	0.06 - 0.18
Grease	0.09
Oil	0.04
Water	0.04

Table 4.4: Coefficients of friction for iglide® J against steel (Shaft finish = 40 rms, 50 HRC)

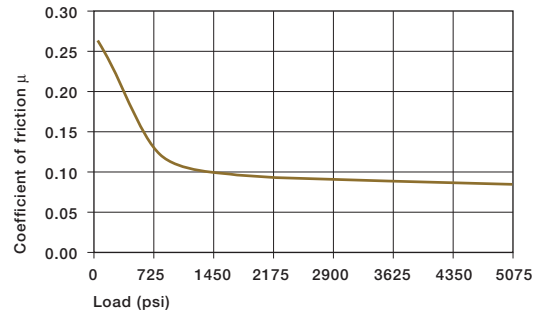

Graph 4.5: Coefficient of friction of iglide® J as a result of the load, v = 1.97 fpm

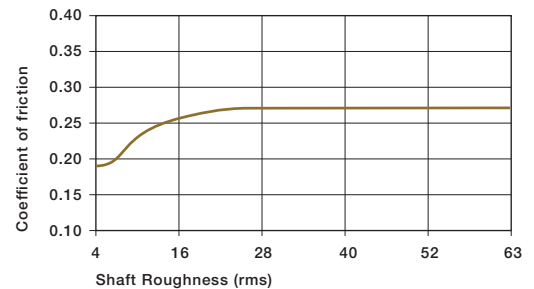

Graph 4.6: Coefficient of friction of iglide® J as a result of the shaft surface (shaft Cold Rolled Steel)

Shaft Materials

Graph 4.7 and 4.9 show results of testing different shaft materials with plain bearings made of iglide® J.

If iglide® J plain bearings are used in rotational applications with loads under 290 psi, several shaft materials are suitable. A Hard Chromed shaft provides the lowest wear in this range. When compared to most iglide® materials, iglide® J has very low wear results at low loads with all shaft materials tested.

Also, for increasing loads up to 725 psi, the wear resistance of iglide® J is excellent. Especially suitable is the combination of 303 stainless steel. In oscillating operation with Cold Rolled Steel and HR Carbon Steel, the wear of iglide® J is slightly higher than for rotation. For oscillating movements with loads of 290 psi, iglide® J performs best with Cold Rolled Steel shaft.

As Graph 4.9 shows, the difference in wear between rotation and oscillating movements is most significant for 303 stainless steel shafts.

If the shaft material you plan to use is not contained in this list, please contact us.

➤ Shaft Materials, Page 1.11

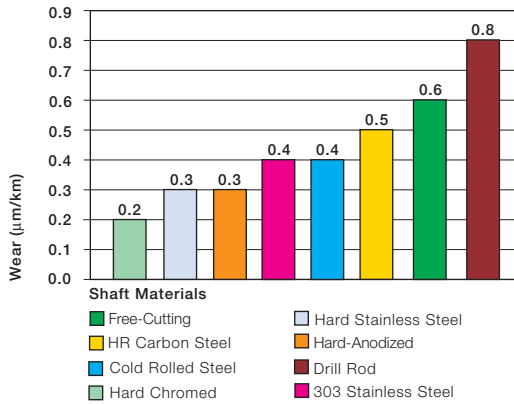

Graph 4.7: Wear of iglide® J, rotating application with different shaft materials, p = 108 psi, v = 98 fpm

Chemical Resistance

iglide® J plain bearings are resistant to diluted lyes and very weak acids, as well as fuels and all types of lubricants. The low moisture absorption also permits use in wet or damp environments. Plain bearings made of iglide® J are resistant to common cleaning agents used in the food industry.

The moisture absorption of iglide® J plain bearings is 0.3% in standard atmosphere. The saturation limit in water is 1.3%. These values are so low that possible design changes due to absorption are only necessary in extreme cases.

➤ Chemical Resistance, Page 1.16

Medium	Resistance
Alcohol	+
Hydrocarbons, chlorinated	+
Greases, oils without additives	+
Fuels	+
Weak acids	0 to -
Strong acids	-
Weak alkaline	+
Strong alkaline	+ to 0

+ resistant, 0 conditionally resistant, - not resistant

Table 4.5: Chemical resistance of iglide® J
All data given concerns the chemical resistance at room temperature (68°F). For a complete list, see page 1.16

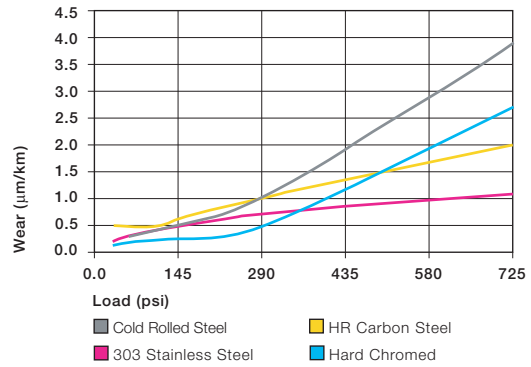

Graph 4.8: Wear of iglide® J, rotating application with different shaft materials, depending on load

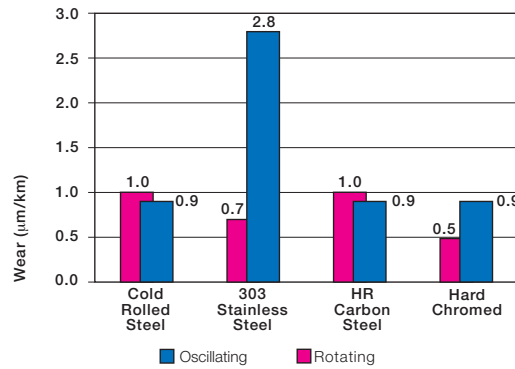

Graph 4.9: Wear for oscillating and rotating applications with different shaft materials under constant load p = 290 psi

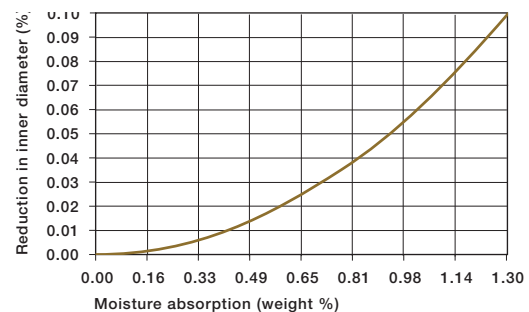

Graph 4.10: Effect of moisture absorption on iglide® J plain bearings



iglide® J

Telephone 1-800-521-2747
Fax 1-401-438-7270

Internet: <http://www.igus.com>
email: sales@igus.com
QuickSpec: <http://www.igus.com/iglide-quickspec>

Radiation Resistance

Plain bearings made from iglide® J are resistant to radiation up to an intensity of 3×10^2 Gy.

UV-Resistance

iglide® J plain bearings become discolored under UV radiation. However, hardness, compressive strength and the wear resistance of the material do not change.

Vacuum

When used in a vacuum environment, the iglide® J plain bearings release moisture as a vapor. Therefore, only dehumidified bearings made of iglide® J are suitable for the vacuum environment.

Electrical Properties

iglide® J plain bearings are electrically insulating.

iglide® J

Specific volume resistance	> $10^{13} \Omega\text{cm}$
----------------------------	-----------------------------

Surface resistance	> $10^{12} \Omega$
--------------------	--------------------

Table 4.6: Electrical properties of iglide® J

iglide® Plain Bearings J - Sleeve Bearing, Inch

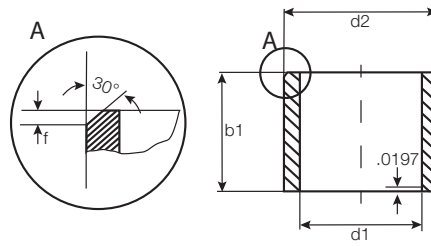

For tolerance values
please refer to page 4.4

iglide® J
Sleeve - Inch

Part Number	d1	d2	b1	I.D. After Pressfit		Housing Bore		Shaft Size	
				Max.	Min.	Max.	Min.	Max.	Min.
JSI-0204-04	1/8	1/4	1/4	.1280	.1262	.2515	.2510	.1250	.1241
JSI-0204-06	1/8	1/4	3/8	.1280	.1262	.2515	.2510	.1250	.1241
JSI-0304-06	3/16	1/4	3/8	.1905	.1886	.2506	.2500	.1865	.1858
JSI-0304-08	3/16	1/4	1/2	.1905	.1886	.2506	.2500	.1865	.1858
JSI-0305-05	3/16	5/16	5/16	.1905	.1887	.3140	.3135	.1875	.1866
JSI-0305-06	3/16	5/16	3/8	.1905	.1887	.3140	.3135	.1875	.1866
JSI-0305-08	3/16	5/16	1/2	.1905	.1887	.3140	.3135	.1875	.1866
JSI-0405-04	1/4	5/16	1/4	.2539	.2516	.3140	.3135	.2500	.2491
JSI-0405-06	1/4	5/16	3/8	.2539	.2516	.3140	.3135	.2500	.2491
JSI-0405-08	1/4	5/16	1/2	.2539	.2516	.3140	.3135	.2500	.2491
JSI-0406-04	1/4	3/8	1/4	.2539	.2516	.3765	.3760	.2500	.2491
JSI-0406-08	1/4	3/8	1/2	.2539	.2516	.3765	.3760	.2500	.2491
JSI-0406-12	1/4	3/8	3/4	.2539	.2516	.3765	.3760	.2500	.2491
JSI-0406-16	1/4	3/8	1	.2539	.2516	.3765	.3760	.2500	.2491
JSI-0506-06	5/16	3/8	3/8	.3148	.3125	.3753	.3747	.3115	.3106
JSI-0506-08	5/16	3/8	1/2	.3148	.3125	.3753	.3747	.3115	.3106
JSI-0506-12	5/16	3/8	3/4	.3148	.3125	.3753	.3747	.3115	.3106
JSI-0507-06	5/16	7/16	3/8	.3164	.3141	.4390	.4385	.3125	.3116
JSI-0507-08	5/16	7/16	1/2	.3164	.3141	.4390	.4385	.3125	.3116
JSI-0507-10	5/16	7/16	5/8	.3164	.3141	.4390	.4385	.3125	.3116
JSI-0607-06	3/8	15/32	3/8	.3773	.3750	.4381	.4375	.3750	.3736
JSI-0607-08	3/8	7/16	1/2	.3783	.3760	.4381	.4375	.3750	.3736
JSI-0608-03	3/8	1/2	3/16	.3787	.3764	.5006	.5000	.3750	.3736
JSI-0608-06	3/8	1/2	3/8	.3787	.3764	.5006	.5000	.3750	.3736
JSI-0608-08	3/8	1/2	1/2	.3787	.3764	.5006	.5000	.3750	.3736
JSI-0608-10	3/8	1/2	5/8	.3787	.3764	.5006	.5000	.3750	.3736
JSI-0708-08	7/16	17/32	1/2	.4406	.4379	.5316	.5309	.4375	.4366
JSI-0709-06	7/16	19/32	3/8	.4406	.4379	.5632	.5625	.4375	.4366
JSI-0809-06	1/2	19/32	3/8	.5047	.5020	.5941	.5934	.5000	.4983
JSI-0809-08	1/2	19/32	1/2	.5047	.5020	.5941	.5934	.5000	.4983
JSI-0809-12	1/2	19/32	3/4	.5047	.5020	.5941	.5934	.5000	.4983
JSI-0809-16	1/2	19/32	1	.5047	.5020	.5941	.5934	.5000	.4983
JSI-0810-04	1/2	5/8	1/4	.5047	.5020	.6260	.6250	.5000	.4990
JSI-0810-08	1/2	5/8	1/2	.5047	.5020	.6260	.6250	.5000	.4990
JSI-0810-12	1/2	5/8	3/4	.5047	.5020	.6260	.6250	.5000	.4990
JSI-0910-26	9/16	21/32	1 5/8	.5655	.5627	.6566	.6559	.5615	.5605
JSI-1011-08	5/8	23/32	1/2	.6280	.6253	.7192	.7184	.6240	.6230
JSI-1011-12	5/8	23/32	3/4	.6280	.6253	.7192	.7184	.6240	.6230

PDF: www.igus.com/iglide-pdfs
CAD: www.igus.com/iglide-CAD
RoHS info: www.igus.com/RoHS





iglide® Plain Bearings J - Sleeve Bearing, Inch

iglide® J
Sleeve - Inch

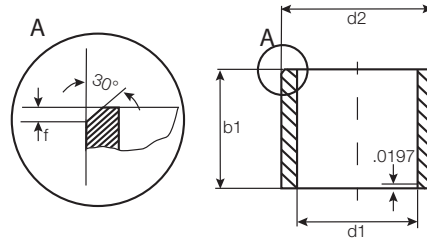

For tolerance values
please refer to page 4.4

Telephone 1-800-521-2747
Fax 1-401-438-7270

Internet: <http://www.igus.com>
email: sales@igus.com
QuickSpec: <http://www.igus.com/iglide-quickspec>

Part Number	d1	d2	b1	I.D. After Pressfit		Housing Bore		Shaft Size	
				Max.	Min.	Max.	Min.	Max.	Min.
JSI-1011-14	5/8	23/32	7/8	.6280	.6253	.7192	.7184	.6240	.6230
JSI-1011-20	5/8	23/32	1 1/4	.6280	.6253	.7192	.7184	.6240	.6230
JSI-1012-04	5/8	3/4	1/4	.6297	.6270	.7510	.7500	.6250	.6240
JSI-1012-06	5/8	3/4	3/8	.6297	.6270	.7510	.7500	.6250	.6240
JSI-1012-08	5/8	3/4	1/2	.6297	.6270	.7510	.7500	.6250	.6240
JSI-1012-12	5/8	3/4	3/4	.6297	.6270	.7510	.7500	.6250	.6240
JSI-1012-16	5/8	3/4	1	.6297	.6270	.7510	.7500	.6250	.6240
JSI-1214-08	3/4	7/8	1/2	.7541	.7505	.8755	.8747	.7491	.7479
JSI-1214-12	3/4	7/8	3/4	.7541	.7505	.8755	.8747	.7491	.7479
JSI-1214-16	3/4	7/8	1	.7541	.7505	.8755	.8747	.7491	.7479
JSI-1216-12	3/4	1	3/4	.7559	.7525	1.0010	1.000	.7500	.7490
JSI-1216-16	3/4	1	1	.7559	.7525	1.0010	1.000	.7500	.7490
JSI-1315-15	13/16	15/16	15/16	.8174	.8141	.9383	.9375	.8125	.8105
JSI-1315-18	13/16	15/16	1 1/8	.8174	.8141	.9383	.9375	.8125	.8105
JSI-1416-12	7/8	1	3/4	.8791	.8757	1.0005	.9997	.8741	.8729
JSI-1418-12	7/8	1 1/8	3/4	.8809	.8775	1.1258	1.1250	.8750	.8740
JSI-1418-24	7/8	1 1/8	1 1/2	.8809	.8775	1.1258	1.1250	.8750	.8740
JSI-1618-16	1	1 1/8	1	1.0041	1.0007	1.1255	1.1250	.9991	.9979
JSI-1618-24	1	1 1/8	1 1/2	1.0041	1.0007	1.1255	1.1250	.9991	.9979
JSI-1620-12	1	1 1/4	3/4	1.0059	1.0025	1.2510	1.2500	1.0000	.9990
JSI-1620-16	1	1 1/4	1	1.0059	1.0025	1.2510	1.2500	1.0000	.9990
JSI-1620-24	1	1 1/4	1 1/2	1.0059	1.0025	1.2510	1.2500	1.0000	.9990
JSI-1822-16	1 1/8	1 3/8	1	1.1327	1.1276	1.3760	1.3750	1.1250	1.1240
JSI-2022-14	1 1/4	1 13/32	7/8	1.2548	1.2508	1.4068	1.4058	1.2488	1.2472
JSI-2024-24	1 1/4	1 1/2	1 1/2	1.2600	1.2532	1.5005	1.4995	1.2500	1.2490
JSI-2426-32	1 1/2	1 5/8	2	1.5100	1.5032	1.6568	1.6558	1.4988	1.4972
JSI-2428-24	1 1/2	1 3/4	1 1/2	1.5100	1.5032	1.7505	1.7495	1.5000	1.4990
JSI-2832-20	1 3/4	2	1 1/4	1.7547	1.7507	2.0010	2.0000	1.7500	1.7476

iglide® Plain Bearings

J - Flange Bearing, Inch

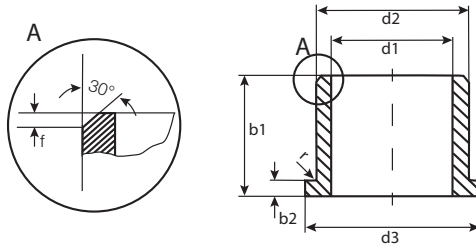

For tolerance values
please refer to page 4.4

r = max. .0197

Part Number	d1	d2	b1	d3	b2	I.D. After Pressfit		Housing Bore		Shaft Size	
						Max.	Min.	Max.	Min.	Max.	Min.
JFI-0204-06	1/8	1/4	3/8	.360	.047	.1280	.1262	.2515	.2510	.1250	.1241
JFI-0304-02	3/16	1/4	1/8	.375	.032	.1905	.1887	.2503	.2497	.1865	.1858
JFI-0304-04	3/16	1/4	1/4	.375	.032	.1905	.1887	.2503	.2497	.1865	.1858
JFI-0304-06	3/16	1/4	3/8	.375	.032	.1905	.1877	.2503	.2497	.1865	.1858
JFI-0304-08	3/16	1/4	1/2	.375	.032	.1905	.1887	.2503	.2497	.1865	.1858
JFI-0305-06	3/16	5/16	3/8	.370	.047	.1905	.1887	.3140	.3135	.1875	.1866
JFI-0305-08	3/16	5/16	1/2	.370	.047	.1905	.1887	.3140	.3135	.1875	.1866
JFI-0405-04	1/4	5/16	1/4	.430	.032	.2539	.2516	.3122	.3128	.2481	.2490
JFI-0405-06	1/4	5/16	3/8	.430	.032	.2539	.2516	.3122	.3128	.2481	.2490
JFI-0405-12	1/4	5/16	3/4	.430	.032	.2539	.2516	.3122	.3128	.2481	.2490
JFI-0406-03	1/4	3/8	3/16	.560	.047	.2539	.2516	.3765	.3760	.2500	.2491
JFI-0406-04	1/4	3/8	1/4	.560	.047	.2539	.2516	.3765	.3760	.2500	.2491
JFI-0406-08	1/4	3/8	1/2	.560	.047	.2539	.2516	.3765	.3760	.2500	.2491
JFI-0506-04	5/16	3/8	1/4	.500	.032	.3148	.3125	.3753	.3747	.3115	.3106
JFI-0506-06	5/16	3/8	3/8	.500	.032	.3148	.3125	.3753	.3747	.3115	.3106
JFI-0506-08	5/16	3/8	1/2	.500	.032	.3148	.3125	.3753	.3747	.3115	.3106
JFI-0507-08	5/16	7/16	1/2	.560	.062	.3164	.3141	.4390	.4385	.3125	.3116
JFI-0607-06	3/8	15/32	3/8	.687	.046	.3775	.3750	.4691	.4684	.3740	.3731
JFI-0607-08	3/8	15/32	1/2	.687	.046	.3775	.3750	.4691	.4684	.3740	.3731
JFI-0608-03	3/8	1/2	3/16	.625	.062	.3789	.3766	.5015	.5010	.3750	.3741
JFI-0608-04	3/8	1/2	1/4	.625	.062	.3789	.3766	.5015	.5010	.3750	.3741
JFI-0608-06	3/8	1/2	3/8	.625	.062	.3789	.3766	.5015	.5010	.3750	.3741
JFI-0608-08	3/8	1/2	1/2	.625	.062	.3789	.3766	.5015	.5010	.3750	.3741
JFI-0809-04	1/2	19/32	1/4	.875	.046	.5040	.5000	.5941	.5934	.4990	.4980
JFI-0809-06	1/2	19/32	3/8	.875	.046	.5040	.5000	.5941	.5934	.4990	.4980
JFI-0809-08	1/2	19/32	1/2	.875	.046	.5040	.5000	.5941	.5934	.4990	.4980
JFI-0810-04	1/2	5/8	1/4	.875	.062	.5047	.5020	.6260	.6250	.5000	.4990
JFI-0810-08	1/2	5/8	1/2	.875	.062	.5047	.5020	.6260	.6250	.5000	.4990
JFI-0810-10	1/2	5/8	5/8	.875	.062	.5047	.5020	.6260	.6250	.5000	.4990
JFI-0810-12	1/2	5/8	3/4	.875	.062	.5047	.5020	.6260	.6250	.5000	.4990
JFI-1011-06	5/8	23/32	3/8	.937	.046	.6280	.6253	.7192	.7184	.6250	.6233
JFI-1011-08	5/8	23/32	1/2	.937	.046	.6280	.6253	.7192	.7184	.6250	.6233
JFI-1011-12	5/8	23/32	3/4	1.000	.046	.6295	.6268	.7192	.7184	.6250	.6233
JFI-1012-08	5/8	3/4	1/2	1.000	.062	.6297	.6270	.7510	.7500	.6250	.6240
JFI-1012-12	5/8	3/4	3/4	1.000	.062	.6297	.6270	.7510	.7500	.6250	.6240
JFI-1012-16	5/8	3/4	1	1.000	.062	.6297	.6270	.7510	.7500	.6250	.6240
JFI-1214-08	3/4	7/8	1/2	1.125	.062	.7541	.7505	.8755	.8747	.7491	.7479
JFI-1214-09	3/4	7/8	9/16	1.125	.062	.7541	.7505	.8755	.8747	.7491	.7479
JFI-1214-10	3/4	7/8	5/8	1.125	.062	.7541	.7505	.8755	.8747	.7491	.7479
JFI-1214-12	3/4	7/8	3/4	1.125	.062	.7541	.7505	.8755	.8747	.7491	.7479
JFI-1214-16	3/4	7/8	1	1.125	.062	.7541	.7505	.8755	.8747	.7491	.7479

iglide® J
Flange - Inch

PDF: www.igus.com/iglide-pdfs
CAD: www.igus.com/iglide-CAD
RoHS info: www.igus.com/RoHS

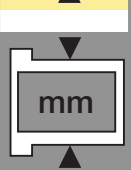



iglide® Plain Bearings J - Flange Bearing, Inch

iglide® J
Flange - Inch

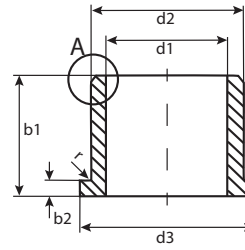
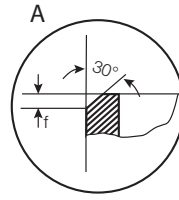

For tolerance values
please refer to page 4.4

$r = \text{max. } .0197$

Telephone 1-800-521-2747
Fax 1-401-438-7270

Internet: <http://www.igus.com>
email: sales@igus.com
QuickSpec: <http://www.igus.com/iglide-quickspec>

Part Number	d1	d2	b1	d3	b2 -.0055	I.D. After Pressfit		Housing Bore		Shaft Size	
						Max.	Min.	Max.	Min.	Max.	Min.
JFI-1216-12	3/4	1	3/4	1.250	.156	.7559	.7525	1.0010	1.0000	.7500	.7490
JFI-1216-16	3/4	1	1	1.250	.156	.7559	.7525	1.0010	1.0000	.7500	.7490
JFI-1416-12	7/8	1	3/4	1.250	.062	.8791	.8757	1.0005	.9997	.8741	.8729
JFI-141618-11	7/8	1	11/16	1.125	.062	.8807	.8774	1.0005	.9997	.8750	.8740
JFI-1418-24	7/8	1 1/8	1 1/2	1.375	.156	.8809	.8775	1.1260	1.1250	.8750	.8740
JFI-1618-12	1	1 1/8	3/4	1.375	.062	1.0041	1.0007	1.1255	1.1247	.9991	.9979
JFI-1618-16	1	1 1/8	1	1.375	.062	1.0041	1.0007	1.1255	1.1247	.9991	.9979
JFI-1620-12	1	1 1/4	3/4	1.500	.188	1.0059	1.0025	1.2510	1.2500	1.0000	.9990
JFI-1620-16	1	1 1/4	1	1.500	.188	1.0059	1.0025	1.2510	1.2500	1.0000	.9990
JFI-1620-24	1	1 1/4	1 1/2	1.500	.188	1.0059	1.0025	1.2510	1.2500	1.0000	.9990
JFI-2024-16	1 1/4	1 1/2	1	1.750	.200	1.2600	1.2531	1.5005	1.4995	1.2500	1.2490
JFI-2024-24	1 1/4	1 1/2	1 1/2	1.750	.200	1.2600	1.2531	1.5005	1.4995	1.2500	1.2490
JFI-2428-16	1 1/2	1 3/4	1	2.000	.125	1.5100	1.5032	1.7505	1.7495	1.5000	1.4990
JFI-2428-24	1 1/2	1 3/4	1 1/2	2.000	.125	1.5100	1.5032	1.7505	1.7495	1.5000	1.4990
JFI-2630-16	1 5/8	1 7/8	1	2.125	.125	1.6350	1.6282	1.8755	1.8745	1.6250	1.6240
JFI-3236-16	2.0	2 1/4	1	2.500	.125	2.0100	2.0032	2.2505	2.2495	2.0000	1.9990

iglide® Plain Bearings J - Sleeve Bearing, MM

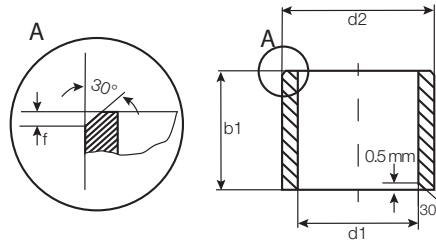

For tolerance values
please refer to page 4.4

Dimensions according to ISO 3547-1 and special dimensions

Part Number	d1	d1-Tolerance after pressfit in Ø H7	d2	b1 h13	I.D. After Pressfit		Housing Bore		Shaft Size	
					Max.	Min.	Max.	Min.	Max.	Min.
JSM-0104-02	1.5	+0.020 +0.080	4.0	2.0	1.580	1.520	4.012	4.000	1.500	1.475
JSM-0205-02	2.0	+0.020 +0.080	5.0	2.0	2.080	2.020	5.012	5.000	2.000	1.975
JSM-0206-02	2.5	+0.020 +0.080	6.0	2.5	2.080	2.020	6.012	6.000	2.000	1.975
JSM-0304-05	3.0	+0.014 +0.054	4.5	5.0	3.054	3.014	4.512	4.500	3.000	2.975
JSM-0304-09	3.0	+0.014 +0.054	4.5	9.0	3.054	3.014	4.512	4.500	3.000	2.975
JSM-0305-04	3.0	+0.020 +0.080	5.0	4.0	3.080	3.020	5.012	5.000	3.000	2.975
JSM-0308-04	3.0	+0.020 +0.080	8.0	4.0	3.080	3.020	8.015	8.000	3.000	2.975
JSM-0308-05	3.0	+0.020 +0.080	8.0	5.0	3.080	3.020	8.015	8.000	3.000	2.975
JSM-0405-04	4.0	+0.020 +0.068	5.5	4.0	4.068	4.020	5.512	5.500	4.000	3.970
JSM-0405-08	4.0	+0.020 +0.068	5.5	8.0	4.068	4.020	5.512	5.500	4.000	3.970
JSM-0507-046	5.0	+0.020 +0.068	7.0	4.6	5.068	5.020	7.015	7.000	5.000	4.970
JSM-0507-05	5.0	+0.020 +0.068	7.0	5.0	5.068	5.020	7.015	7.000	5.000	4.970
JSM-0507-10	5.0	+0.020 +0.068	7.0	10.0	5.068	5.020	7.015	7.000	5.000	4.970
JSM-0507-15	5.0	+0.020 +0.068	7.0	15.0	5.068	5.020	7.015	7.000	5.000	4.970
JSM-0607-08	6.0	+0.010 +0.058	7.0	8.0	6.058	6.010	7.015	7.000	6.000	5.970
JSM-0607-12.5	6.0	+0.010 +0.058	7.0	12.5	6.058	6.010	7.015	7.000	6.000	5.970
JSM-0607-14	6.0	+0.010 +0.058	7.0	14.0	6.058	6.010	7.015	7.000	6.000	5.970
JSM-0608-043	6.0	+0.020 +0.068	8.0	4.3	6.058	6.020	8.015	8.000	6.000	5.970
JSM-0608-06	6.0	+0.020 +0.068	8.0	6.0	6.068	6.020	8.015	8.000	6.000	5.970
JSM-0608-10	6.0	+0.020 +0.068	8.0	10.0	6.068	6.020	8.015	8.000	6.000	5.970
JSM-0609-06	6.0	+0.030 +0.105	9.0	6.0	6.105	6.030	9.015	9.000	6.000	5.970
JSM-0610-10	6.0	+0.030 +0.105	10.0	10.0	6.105	6.030	10.015	10.000	6.000	5.970
JSM-0709-09	7.0	+0.025 +0.083	9.0	9.0	7.083	7.025	9.015	9.000	7.000	6.964
JSM-0810-04	8.0	+0.025 +0.083	10.0	4.0	8.083	8.025	10.015	10.000	8.000	7.964
JSM-0810-06	8.0	+0.025 +0.083	10.0	6.0	8.083	8.025	10.015	10.000	8.000	7.964
JSM-0810-08	8.0	+0.025 +0.083	10.0	8.0	8.083	8.025	10.015	10.000	8.000	7.964
JSM-0810-10	8.0	+0.025 +0.083	10.0	10.0	8.083	8.025	10.015	10.000	8.000	7.964
JSM-0810-12	8.0	+0.025 +0.083	10.0	12.0	8.083	8.025	10.015	10.000	8.000	7.964
JSM-0810-16	8.0	+0.025 +0.083	10.0	16.0	8.083	8.025	10.015	10.000	8.000	7.964
JSM-0812-10	8.0	+0.040 +0.130	12.0	10.0	8.130	8.040	12.018	12.000	8.000	7.964
JSM-0812-12	8.0	+0.040 +0.130	12.0	12.0	8.130	8.040	12.018	12.000	8.000	7.964
JSM-1012-05	10.0	+0.025 +0.083	12.0	5.0	10.083	10.025	12.018	12.000	10.000	9.964
JSM-1012-06	10.0	+0.025 +0.083	12.0	6.0	10.083	10.025	12.018	12.000	10.000	9.964
JSM-1012-08	10.0	+0.025 +0.083	12.0	8.0	10.083	10.025	12.018	12.000	10.000	9.964
JSM-1012-10	10.0	+0.025 +0.083	12.0	10.0	10.083	10.025	12.018	12.000	10.000	9.964
JSM-1012-11	10.0	+0.025 +0.083	12.0	11.0	10.083	10.025	12.018	12.000	10.000	9.964
JSM-1012-12	10.0	+0.025 +0.083	12.0	12.0	10.083	10.025	12.018	12.000	10.000	9.964
JSM-1012-15	10.0	+0.025 +0.083	12.0	15.0	10.083	10.025	12.018	12.000	10.000	9.964
JSM-1012-20	10.0	+0.025 +0.083	12.0	20.0	10.083	10.025	12.018	12.000	10.000	9.964
JSM-1014-10	10.0	+0.040 +0.130	14.0	10.0	10.130	10.040	14.018	14.000	10.000	9.964

iglide® J
Sleeve - MM

PDF: www.igus.com/iglide-pdfs
CAD: www.igus.com/iglide-CAD
RoHS info: www.igus.com/RoHS

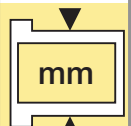
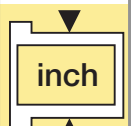



iglide® Plain Bearings J - Sleeve Bearing, MM

iglide® J
Sleeve - MM

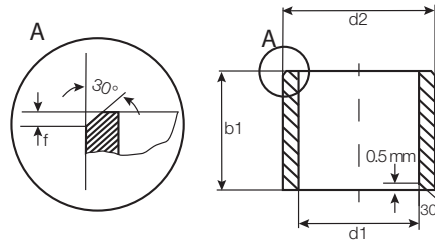

For tolerance values
please refer to page 4.4

Dimensions according to ISO 3547-1 and special dimensions

Part Number	d1		d2	b1	I.D. After Pressfit		Housing Bore		Shaft Size	
	after pressfit in Ø H7				h13	Max.	Min.	Max.	Min.	Max.
JSM-1014-16	10.0	+0.040 +0.130	14.0	16.0	10.130	10.040	14.018	14.000	10.000	9.964
JSM-1214-06	12.0	+0.032 +0.102	14.0	6.0	12.102	12.032	14.018	14.000	12.000	11.957
JSM-1214-08	12.0	+0.032 +0.102	14.0	8.0	12.102	12.032	14.018	14.000	12.000	11.957
JSM-1214-09	12.0	+0.032 +0.102	14.0	9.0	12.102	12.032	14.018	14.000	12.000	11.957
JSM-1214-10	12.0	+0.032 +0.102	14.0	10.0	12.102	12.032	14.018	14.000	12.000	11.957
JSM-1214-15	12.0	+0.032 +0.102	14.0	15.0	12.102	12.032	14.018	14.000	12.000	11.957
JSM-1216-12	12.0	+0.050 +0.160	16.0	12.0	12.160	12.050	16.018	16.000	12.000	11.957
JSM-1216-17	12.0	+0.050 +0.160	16.0	17.0	12.160	12.050	16.018	16.000	12.000	11.957
JSM-1416-05	14.0	+0.032 +0.102	16.0	5.0	14.102	14.032	16.018	16.000	14.000	13.957
JSM-1416-08	14.0	+0.032 +0.102	16.0	8.0	14.102	14.032	16.018	16.000	14.000	13.957
JSM-1416-10	14.0	+0.032 +0.102	16.0	10.0	14.102	14.032	16.018	16.000	14.000	13.957
JSM-1416-15	14.0	+0.032 +0.102	16.0	15.0	14.102	14.032	16.018	16.000	14.000	13.957
JSM-1416-20	14.0	+0.032 +0.102	16.0	20.0	14.102	14.032	16.018	16.000	14.000	13.957
JSM-1416-25	14.0	+0.032 +0.102	16.0	25.0	14.102	14.032	16.018	16.000	14.000	13.957
JSM-1418-18	14.0	+0.032 +0.102	18.0	18.0	14.102	14.032	18.018	18.000	14.000	13.957
JSM-1517-12	15.0	+0.032 +0.102	17.0	12.0	15.102	15.032	17.018	17.000	15.000	14.957
JSM-1517-20	15.0	+0.032 +0.102	17.0	20.0	15.102	15.032	17.018	17.000	15.000	14.957
JSM-1618-10	16.0	+0.032 +0.102	18.0	10.0	16.102	16.032	18.018	18.000	16.000	15.957
JSM-1618-12	16.0	+0.032 +0.102	18.0	12.0	16.102	16.032	18.018	18.000	16.000	15.957
JSM-1618-15	16.0	+0.032 +0.102	18.0	15.0	16.102	16.032	18.018	18.000	16.000	15.957
JSM-1618-20	16.0	+0.032 +0.102	18.0	20.0	16.102	16.032	18.018	18.000	16.000	15.957
JSM-1620-16	16.0	+0.050 +0.160	20.0	16.0	16.160	16.050	20.021	20.000	16.000	15.957
JSM-1622-16	16.0	+0.050 +0.160	22.0	16.0	16.160	16.050	22.021	22.000	16.000	15.957
JSM-1622-20	16.0	+0.050 +0.160	22.0	20.0	16.160	16.050	22.021	22.000	16.000	15.957
JSM-1820-15	18.0	+0.032 +0.102	20.0	15.0	18.102	18.032	20.021	20.000	18.000	17.957
JSM-1820-20	18.0	+0.032 +0.102	20.0	20.0	18.102	18.032	20.021	20.000	18.000	17.957
JSM-2022-20	20.0	+0.040 +0.124	22.0	20.0	20.124	20.040	22.021	22.000	20.000	19.948
JSM-2022-30	20.0	+0.040 +0.124	22.0	30.0	20.124	20.040	22.021	22.000	20.000	19.948
JSM-2023-15	20.0	+0.040 +0.124	23.0	15.0	20.124	20.040	23.021	23.000	20.000	19.948
JSM-2023-20	20.0	+0.040 +0.124	23.0	20.0	20.124	20.040	23.021	23.000	20.000	19.948
JSM-2023-25	20.0	+0.040 +0.124	23.0	25.0	20.124	20.040	23.021	23.000	20.000	19.948
JSM-2026-06	20.0	+0.065 +0.195	26.0	6.0	20.124	20.040	26.021	26.000	20.000	19.948
JSM-2026-20	20.0	+0.065 +0.195	26.0	20.0	20.124	20.040	26.021	26.000	20.000	19.948
JSM-2026-25	20.0	+0.065 +0.195	26.0	25.0	20.124	20.040	26.021	26.000	20.000	19.948
JSM-2026-30	20.0	+0.065 +0.195	26.0	30.0	20.124	20.040	26.021	26.000	20.000	19.948
JSM-2427-25	24.0	+0.040 +0.124	27.0	25.0	24.124	24.040	27.021	27.000	24.000	23.948
JSM-2427-46	24.0	+0.040 +0.124	27.0	46.0	24.124	24.040	27.021	27.000	24.000	23.948
JSM-2528-12	25.0	+0.040 +0.124	28.0	12.0	25.124	25.040	28.021	28.000	25.000	24.948
JSM-2528-20	25.0	+0.040 +0.124	28.0	20.0	25.124	25.040	28.021	28.000	25.000	24.948
JSM-2528-30	25.0	+0.040 +0.124	28.0	30.0	25.124	25.040	28.021	28.000	25.000	24.948

Telephone 1-800-521-2747
Fax 1-401-438-7270

Internet: <http://www.igus.com>
email: sales@igus.com
QuickSpec: <http://www.igus.com/iglide-quickspec>

iglide® Plain Bearings J - Sleeve Bearing, MM

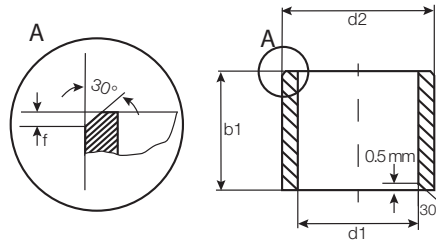

For tolerance values
please refer to page 4.4

Dimensions according to ISO 3547-1 and special dimensions

Part Number	d1	d1-Tolerance after pressfit in Ø H7	d2	b1 h13	I.D. After Pressfit		Housing Bore		Shaft Size	
					Max.	Min.	Max.	Min.	Max.	Min.
JSM-2528-60	25.0	+0.040 +0.124	28.0	60.0	25.124	25.040	28.021	28.000	25.000	24.948
JSM-2532-25	25.0	+0.065 +0.195	32.0	25.0	25.195	25.065	32.025	32.000	25.000	24.948
JSM-2532-35	25.0	+0.065 +0.195	32.0	35.0	25.195	25.065	32.025	32.000	25.000	24.948
JSM-2630-20	26.0	+0.065 +0.195	30.0	20.0	26.195	26.065	30.025	30.000	26.000	25.948
JSM-2832-20	28.0	+0.065 +0.195	32.0	20.0	28.195	28.065	32.025	32.000	28.000	27.948
JSM-2836-29	28.0	+0.065 +0.195	36.0	29.0	28.195	28.065	36.025	36.000	28.000	27.948
JSM-3034-20	30.0	+0.040 +0.124	34.0	20.0	30.124	30.040	34.025	34.000	30.000	29.948
JSM-3034-25	30.0	+0.040 +0.124	34.0	25.0	30.124	30.040	34.025	34.000	30.000	29.948
JSM-3034-30	30.0	+0.040 +0.124	34.0	30.0	30.124	30.040	34.025	34.000	30.000	29.948
JSM-3038-40	30.0	+0.065 +0.195	38.0	40.0	30.195	30.065	38.025	38.000	30.000	29.948
JSM-3236-20	32.0	+0.050 +0.150	36.0	20.0	32.150	32.050	36.025	36.000	32.000	31.938
JSM-3236-30	32.0	+0.050 +0.150	36.0	30.0	32.150	32.050	36.025	36.000	32.000	31.938
JSM-3236-40	32.0	+0.050 +0.150	36.0	40.0	32.150	32.050	36.025	36.000	32.000	31.938
JSM-3539-20	35.0	+0.050 +0.150	39.0	20.0	35.150	35.050	39.025	39.000	35.000	34.938
JSM-3539-30	35.0	+0.050 +0.150	39.0	30.0	35.150	35.050	39.025	39.000	35.000	34.938
JSM-3539-40	35.0	+0.050 +0.150	39.0	40.0	35.150	35.050	39.025	39.000	35.000	34.938
JSM-3640-45	36.0	+0.050 +0.150	40.0	45.0	36.150	36.050	40.025	40.000	36.000	35.938
JSM-4044-30	40.0	+0.050 +0.150	44.0	30.0	40.150	40.050	44.025	44.000	40.000	39.938
JSM-4044-35	40.0	+0.050 +0.150	44.0	35.0	40.150	40.050	44.025	44.000	40.000	39.938
JSM-4044-40	40.0	+0.050 +0.150	44.0	40.0	40.150	40.050	44.025	44.000	40.000	39.938
JSM-5055-30	50.0	+0.050 +0.150	55.0	30.0	50.150	50.050	55.030	55.000	50.000	49.938
JSM-5055-50	50.0	+0.050 +0.150	55.0	50.0	50.150	50.050	55.030	55.000	50.000	49.938
JSM-5560-60	55.0	+0.060 +0.180	60.0	60.0	55.180	55.060	60.030	60.000	55.000	54.926
JSM-6065-60	60.0	+0.060 +0.180	65.0	60.0	60.180	60.060	65.030	65.000	60.000	59.926
JSM-7580-60	75.0	+0.060 +0.180	80.0	60.0	75.180	75.060	80.030	80.000	75.000	74.926

PDF: www.igus.com/iglide-pdfs
CAD: www.igus.com/iglide-CAD
RoHS info: www.igus.com/RoHS

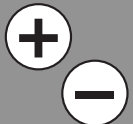



iglide® Plain Bearings J - Flange Bearing, MM

iglide® J
Flange - MM

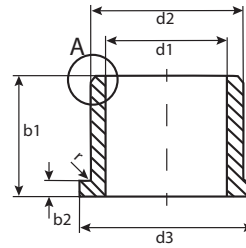
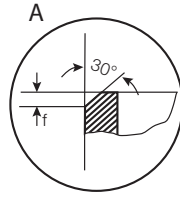

For tolerance values
please refer to page 4.4

r = max. 0.5

Dimensions according to ISO 3547-1 and special dimensions

Part Number	d1 ¹⁾	d1-Tolerance	d2	d3	b1	b2	I.D. After Pressfit		Housing Bore		Shaft Size	
	After Pressfit in Ø H7			d13	h13	-0.14	Max.	Min.	Max.	Min.	Max.	Min.
JFM-0304-05	3.0	+0.014 +0.054	4.5	7.5	5.0	0.75	3.054	3.014	4.512	4.500	3.000	2.975
JFM-0405-03	4.0	+0.020 +0.068	5.5	9.5	3.0	0.75	4.068	4.020	5.512	5.000	4.000	3.970
JFM-0405-06	4.0	+0.020 +0.068	5.5	9.5	6.0	0.75	4.068	4.020	5.512	5.000	4.000	3.970
JFM-0408-04	4.0	+0.030 +0.105	8.0	12.0	4.0	2.0	4.105	4.030	8.015	8.000	4.000	3.970
JFM-0507-03	5.0	+0.020 +0.068	7.0	11.0	3.0	1.0	5.068	5.020	7.015	7.000	5.000	4.970
JFM-0507-05	5.0	+0.020 +0.068	7.0	11.0	5.0	1.0	5.068	5.020	7.015	7.000	5.000	4.970
JFM-0608-04	6.0	+0.020 +0.068	8.0	12.0	4.0	1.0	6.068	6.020	8.015	8.000	6.000	5.970
JFM-0608-06	6.0	+0.020 +0.068	8.0	12.0	6.0	1.0	6.068	6.020	8.015	8.000	6.000	5.970
JFM-0608-08	6.0	+0.020 +0.068	8.0	12.0	8.0	1.0	6.068	6.020	8.015	8.000	6.000	5.970
JFM-0608-10	6.0	+0.020 +0.068	8.0	12.0	10.0	1.0	6.068	6.020	8.015	8.000	6.000	5.970
JFM-0610-10	6.0	+0.030 +0.105	10.0	14.0	10.0	2.0	6.105	6.030	10.015	10.000	6.000	5.970
JFM-0810-05	8.0	+0.025 +0.083	10.0	15.0	5.0	1.0	8.083	8.025	10.015	10.000	8.000	7.964
JFM-0810-06	8.0	+0.025 +0.083	10.0	15.0	6.0	1.0	8.083	8.025	10.015	10.000	8.000	7.964
JFM-0810-07	8.0	+0.025 +0.083	10.0	15.0	7.0	1.0	8.083	8.025	10.015	10.000	8.000	7.964
JFM-0810-08	8.0	+0.025 +0.083	10.0	15.0	8.0	1.0	8.083	8.025	10.015	10.000	8.000	7.964
JFM-0810-10	8.0	+0.025 +0.083	10.0	15.0	10.0	1.0	8.083	8.025	10.015	10.000	8.000	7.964
JFM-081014-10	8.0	+0.025 +0.083	10.0	14.0	10.0	1.0	8.083	8.025	10.015	10.000	8.000	7.964
JFM-081016-11	8.0	+0.025 +0.083	10.0	16.0	11.0	1.0	8.083	8.025	10.015	10.000	8.000	7.964
JFM-0812-05	8.0	+0.040 +0.130	12.0	16.0	5.0	2.0	8.130	8.040	12.018	12.000	8.000	7.964
JFM-0812-06	8.0	+0.040 +0.130	12.0	16.0	6.0	2.0	8.115	8.025	12.018	12.000	8.000	7.964
JFM-0812-30	8.0	+0.040 +0.130	12.0	16.0	30.0	2.0	8.130	8.040	12.018	12.000	8.000	7.964
JFM-101215-035	10.0	+0.025 +0.083	12.0	15.0	3.5	1.0	10.083	10.025	12.018	12.000	10.000	9.964
JFM-1012-05	10.0	+0.025 +0.083	12.0	18.0	5.0	1.0	10.083	10.025	12.018	12.000	10.000	9.964
JFM-1012-09	10.0	+0.025 +0.083	12.0	18.0	9.0	1.0	10.083	10.025	12.018	12.000	10.000	9.964
JFM-1012-10	10.0	+0.025 +0.083	12.0	18.0	10.0	1.0	10.083	10.025	12.018	12.000	10.000	9.964
JFM-1012-12	10.0	+0.025 +0.083	12.0	18.0	12.0	1.0	10.083	10.025	12.018	12.000	10.000	9.964
JFM-1012-15	10.0	+0.025 +0.083	12.0	18.0	15.0	1.0	10.083	10.025	12.018	12.000	10.000	9.964
JFM-1012-18	10.0	+0.025 +0.083	12.0	18.0	18.0	1.0	10.083	10.025	12.018	12.000	10.000	9.964
JFM-1014-14	10.0	+0.040 +0.130	14.0	17.5	14.0	1.0	10.130	10.0410	14.018	14.000	10.000	9.964
JFM-101420-12	10.0	+0.040 +0.130	14.0	20.0	12.0	2.0	10.130	10.040	14.018	14.000	10.000	9.964
JFM-1016-10	10.0	+0.040 +0.130	16.0	22.0	10.0	3.0	10.130	10.040	16.018	16.000	10.000	9.964
JFM-1016-16	10.0	+0.040 +0.130	16.0	22.0	16.0	3.0	10.130	10.040	16.018	16.000	10.000	9.964
JFM-1113-05	11.0	+0.032 +0.102	13.0	18.0	5.0	1.0	11.102	11.032	13.018	13.000	11.000	10.964
JFM-1214-05	12.0	+0.032 +0.102	14.0	20.0	5.0	1.0	12.102	12.032	14.018	14.000	12.000	11.957
JFM-1214-07	12.0	+0.032 +0.102	14.0	20.0	7.0	1.0	12.102	12.032	14.018	14.000	12.000	11.957
JFM-1214-09	12.0	+0.032 +0.102	14.0	20.0	9.0	1.0	12.102	12.032	14.018	14.000	12.000	11.957
JFM-121418-10	12.0	+0.032 +0.102	14.0	18.0	10.0	1.0	12.102	12.032	14.018	14.000	12.000	11.957
JFM-1214-12	12.0	+0.032 +0.102	14.0	20.0	12.0	1.0	12.102	12.032	14.018	14.000	12.000	11.957
JFM-1214-15	12.0	+0.032 +0.102	14.0	20.0	15.0	1.0	12.102	12.032	14.018	14.000	12.000	11.957
JFM-1218-08	12.0	+0.050 +0.160	18.0	24.0	8.0	3.0	12.160	12.050	18.018	18.000	12.000	11.957
JFM-1218-12	12.0	+0.050 +0.160	18.0	24.0	12.0	3.0	12.160	12.050	18.018	18.000	12.000	11.957
JFM-1218-20	12.0	+0.050 +0.160	18.0	22.0	20.0	3.0	12.160	12.050	18.018	18.000	12.000	11.957

Telephone 1-800-521-2747
Fax 1-401-438-7270

Internet: <http://www.igus.com>
email: sales@igus.com
QuickSpec: <http://www.igus.com/iglide-quickspec>

iglide® Plain Bearings

J - Flange Bearing, MM

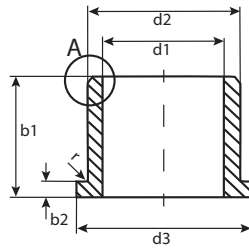
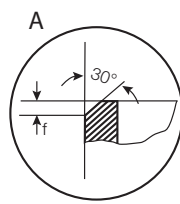

For tolerance values please refer to page 4.4

$r = \max. 0.5$

Dimensions according to ISO 3547-1 and special dimensions

Part Number	d1 ¹⁾	d1-Tolerance		d2	d3	b1	b2	I.D. After Pressfit		Housing Bore		Shaft Size	
		After Pressfit in $\varnothing H7$						Max.	Min.	Max.	Min.	Max.	Min.
JFM-1416-03	14.0	+0.032	+0.102	16.0	22.0	3.0	1.0	14.102	14.032	16.018	16.000	14.000	13.957
JFM-1416-10	14.0	+0.032	+0.102	16.0	22.0	10.0	1.0	14.102	14.032	16.018	16.000	14.000	13.957
JFM-1416-12	14.0	+0.032	+0.102	16.0	22.0	12.0	1.0	14.102	14.032	16.018	16.000	14.000	13.957
JFM-1416-17	14.0	+0.032	+0.102	16.0	22.0	17.0	1.0	14.102	14.032	16.018	16.000	14.000	13.957
JFM-141822-20	14.0	+0.032	+0.102	18.0	22.0	20.0	2.0	14.102	14.032	18.018	18.000	14.000	13.957
JFM-1420-20	14.0	+0.050	+0.160	20.0	25.0	20.0	3.0	14.160	14.050	20.021	20.000	14.000	13.957
JFM-1517-09	15.0	+0.032	+0.102	17.0	23.0	9.0	1.0	15.102	15.032	17.018	17.000	15.000	14.957
JFM-1517-12	15.0	+0.032	+0.102	17.0	23.0	12.0	1.0	15.102	15.032	17.018	17.000	15.000	14.957
JFM-1517-17	15.0	+0.032	+0.102	17.0	23.0	17.0	1.0	15.102	15.032	17.018	17.000	15.000	14.957
JFM-1521-20	15.0	+0.050	+0.160	21.0	27.0	20.0	3.0	15.160	15.050	21.021	21.000	15.000	14.957
JFM-1618-17	16.0	+0.032	+0.102	18.0	24.0	17.0	1.0	16.102	16.032	18.018	18.000	16.000	15.957
JFM-1622-12	16.0	+0.050	+0.160	22.0	28.0	12.0	3.0	16.160	16.050	22.021	22.000	16.000	15.957
JFM-1622-15	16.0	+0.050	+0.160	22.0	28.0	15.0	3.0	16.160	16.050	22.021	22.000	16.000	15.957
JFM-1622-20	16.0	+0.050	+0.160	22.0	28.0	20.0	3.0	16.160	16.050	22.021	22.000	16.000	15.957
JFM-1622-25	16.0	+0.050	+0.160	22.0	28.0	25.0	3.0	16.160	16.050	22.021	22.000	16.000	15.957
JFM-1719-09	17.0	+0.032	+0.102	19.0	25.0	9.0	1.0	17.102	17.032	19.018	19.000	17.000	16.957
JFM-1719-21	17.0	+0.032	+0.102	19.0	25.0	21.0	1.0	17.102	17.032	19.018	19.000	17.000	16.957
JFM-1820-04	18.0	+0.032	+0.102	20.0	26.0	4.0	1.0	18.102	18.032	20.021	20.000	18.000	17.957
JFM-1820-12	18.0	+0.032	+0.102	20.0	26.0	12.0	1.0	18.102	18.032	20.021	20.000	18.000	17.957
JFM-1820-22	18.0	+0.032	+0.102	20.0	26.0	22.0	1.0	18.102	18.032	20.021	20.000	18.000	17.957
JFM-1922-36	19.0	+0.040	+0.124	22.0	26.0	36.0	1.0	19.124	19.040	22.021	22.000	19.000	18.957
JFM-2023-11	20.0	+0.040	+0.124	23.0	30.0	11.0	1.5	20.124	20.040	23.021	23.000	20.000	19.948
JFM-2023-15.5	20.0	+0.040	+0.124	23.0	30.0	15.5	1.5	20.124	20.040	23.021	23.000	20.000	19.948
JFM-2023-21	20.0	+0.040	+0.124	23.0	30.0	21.5	1.5	20.124	20.040	23.021	23.000	20.000	19.948
JFM-202530-15	20.0	+0.065	+0.195	25.0	30.0	15.0	2.5	20.195	20.065	25.021	25.000	20.000	19.948
JFM-2026-15	20.0	+0.065	+0.195	26.0	32.0	15.0	3.0	20.195	20.065	26.021	26.000	20.000	19.948
JFM-2026-20	20.0	+0.065	+0.195	26.0	32.0	20.0	3.0	20.195	20.065	26.021	26.000	20.000	19.948
JFM-2026-25	20.0	+0.065	+0.195	26.0	32.0	25.0	3.0	20.195	20.065	26.021	26.000	20.000	19.948
JFM-2026-30	20.0	+0.065	+0.195	26.0	32.0	30.0	3.0	20.195	20.065	26.021	26.000	20.000	19.948
JFM-222532-08	22.0	+0.040	+0.124	25.0	32.0	8.0	1.5	22.124	22.040	25.021	25.000	22.000	21.948
JFM-2430-30	24.0	+0.040	+0.124	30.0	36.0	30.0	3.0	24.124	24.040	30.021	30.000	24.000	23.948
JFM-2528-06	25.0	+0.040	+0.124	28.0	35.0	6.0	1.5	25.124	25.040	28.021	28.000	25.000	24.948
JFM-2528-14.5	25.0	+0.040	+0.124	28.0	35.0	14.5	1.5	25.124	25.040	28.021	28.000	25.000	24.948
JFM-2528-21	25.0	+0.040	+0.124	28.0	35.0	21.0	1.5	25.124	25.040	28.021	28.000	25.000	24.948
JFM-2532-20	25.0	+0.065	+0.195	32.0	38.0	20.0	4.0	25.195	25.065	32.021	32.000	25.000	24.948
JFM-2532-25	25.0	+0.065	+0.195	32.0	38.0	25.0	4.0	25.195	25.065	32.021	32.000	25.000	24.948
JFM-2532-40	25.0	+0.065	+0.195	32.0	38.0	40.0	2.0	25.195	25.065	32.021	32.000	25.000	24.948
JFM-3034-20	30.0	+0.040	+0.124	34.0	42.0	20.0	2.0	30.124	30.040	34.025	34.000	30.000	29.948
JFM-3034-26	30.0	+0.040	+0.124	34.0	42.0	26.0	2.0	30.124	30.040	34.025	34.000	30.000	29.948
JFM-3038-20	30.0	+0.065	+0.195	38.0	44.0	20.0	4.0	30.195	30.065	38.025	38.000	30.000	29.948
JFM-3038-30	30.0	+0.065	+0.195	38.0	44.0	30.0	4.0	30.195	30.065	38.025	38.000	30.000	29.948
JFM-3038-36	30.0	+0.065	+0.195	38.0	44.0	36.0	4.0	30.195	30.065	38.025	38.000	30.000	29.948

iglide® J
Flange - MM

PDF: www.igus.com/iglide-pdfs
CAD: www.igus.com/iglide-CAD
RoHS info: www.igus.com/RoHS

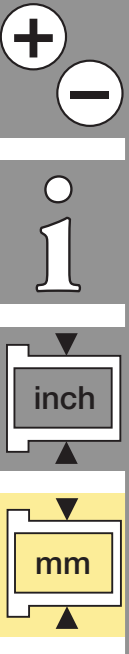



iglide® J
Flange - MM

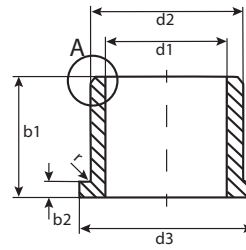
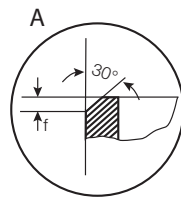

For tolerance values
please refer to page 4.4

$r = \max. 0.5$

Dimensions according to ISO 3547-1 and special dimensions

Part Number	d1 ¹⁾		d2	d3	b1	b2	I.D. After Pressfit		Housing Bore		Shaft Size	
	After Pressfit in Ø H7						Max.	Min.	Max.	Min.	Max.	Min.
JFM-3539-12	35.0	+0.050 +0.150	39.0	47.0	12.0	2.0	35.150	35.050	39.025	39.000	35.000	34.938
JFM-3539-16	35.0	+0.050 +0.150	39.0	47.0	16.0	2.0	35.150	35.050	39.025	39.000	35.000	34.938
JFM-3539-26	35.0	+0.050 +0.150	39.0	47.0	26.0	2.0	35.150	35.050	39.025	39.000	35.000	34.938
JFM-4044-20	40.0	+0.050 +0.150	44.0	52.0	20.0	2.0	40.150	40.050	44.025	44.000	40.000	39.938
JFM-4044-30	40.0	+0.050 +0.150	44.0	52.0	30.0	2.0	40.150	40.050	44.025	44.000	40.000	39.938
JFM-4044-40	40.0	+0.050 +0.150	44.0	52.0	40.0	2.0	40.150	40.050	44.025	44.000	40.000	39.938
JFM-4550-20	45.0	+0.050 +0.150	50.0	58.0	20.0	2.0	45.150	45.050	50.025	50.000	45.000	44.938
JFM-4550-50	45.0	+0.050 +0.150	50.0	58.0	50.0	2.0	45.150	45.050	50.025	50.000	45.000	44.938
JFM-5055-50	50.0	+0.050 +0.150	55.0	63.0	50.0	2.0	50.150	50.050	55.030	55.000	50.000	54.926
JFM-556082-30	55.0	+0.060 +0.180	60.0	82.0	30.0	2.0	55.180	55.060	60.030	60.000	55.000	54.926
JFM-5560-50	55.0	+0.060 +0.180	60.0	68.0	50.0	2.0	55.180	55.060	60.030	60.000	55.000	54.926
JFM-6065-50	60.0	+0.060 +0.180	65.0	73.0	50.0	2.0	60.180	60.060	65.030	65.000	60.000	59.926
JFM-7075-50	70.0	+0.060 +0.180	75.0	83.0	50.0	2.0	70.180	70.060	75.030	75.000	70.000	69.926

Telephone 1-800-521-2747
Fax 1-401-438-7270

Internet: <http://www.igus.com>
email: sales@igus.com
QuickSpec: <http://www.igus.com/iglide-quickspec>

iglide® Plain Bearings

J - Thrust Washer, MM

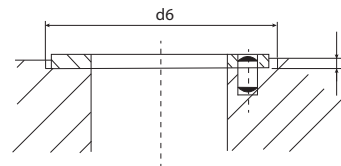
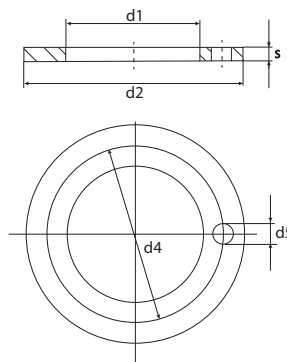

Dimensions according to ISO 3547-1 and special dimensions

Part Number	d1	d2	s	d4	d5	h	d6
	0.3	-0.3	-0.05	-0.12 +0.12	+0.375 +0.125	+0.2 0.2	+0.12
JTM-1224-015	12.0	24.0	1.5	18.0	1.5	1.0	24.0
JTM-2036-015	20.0	36.0	1.5	28.0	3.0	1.0	36.0

igus[®]



iglide[®] G300

Product Range

- Standard Styles:
Sleeve, Flange and Thrust Washer
- Custom shapes and sizes available
- Inner diameters:
Inch sizes from 1/8 - 3 in.
Metric sizes from 1.5 - 150 mm

Part Number Structure

Part Number Structure

G S I-02 03-03

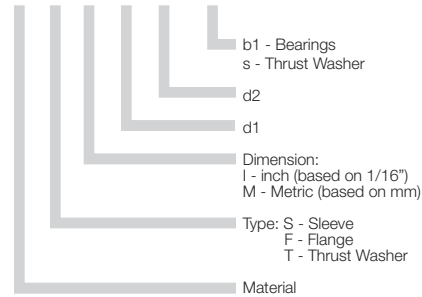

Permissible Surface Speeds

	Continuous fpm	Short Term fpm
Rotating	196	393
Oscillating	137	275
Linear	787	1043

Usage Guidelines



- When you need an economical all-around performance bearing
- For above average loads
- For low to average running speeds
- When the bearing needs to run on different shaft materials
- For oscillating and rotating movements



- When mechanical reaming of the wall surface is necessary
➤ **iglide® M250**
- When the highest wear resistance is necessary
➤ **iglide® L280**
- If temperatures are constantly greater than +266°F
➤ **iglide® T500, F, Z**



Visit www.igus.com
to use our online
expert system

Material Data

General Properties	Unit	iglide® G300	Testing Method
Density	g/cm ³	1.45	
Color		dark gray	
Max. moisture absorption at 73°F / 50% r.h.	% weight	0.7	DIN 53495
Max. moisture absorption	% weight	4.0	
Coefficient of friction, dynamic against steel	μ	0.08 - 0.15	
p x v-value, max. (dry)	psi x fpm	12,000	

Mechanical Properties

Modulus of elasticity	psi	1,131,000	DIN 53457
Tensile strength at 68°F	psi	30,450	DIN 53452
Compressive strength	psi	11,310	
Max. static surface pressure (68°F)	psi	11,600	
Shore D-hardness		81	DIN 53505

Physical and Thermal Properties

Max. long-term application temperature	°F	266	
Max. short-term application temperature	°F	428	
Min. application temperature	°F	-40	
Thermal conductivity	(W/m x K)	0.24	ASTM C 177
Coefficient of thermal expansion (at 73°F)	(K ⁻¹ x 10 ⁻⁵)	9	DIN 53752

Electrical Properties

Specific volume resistance	Ωcm	> 10 ¹³	DIN IEC 93
Surface resistance	Ω	> 10 ¹¹	DIN 53482

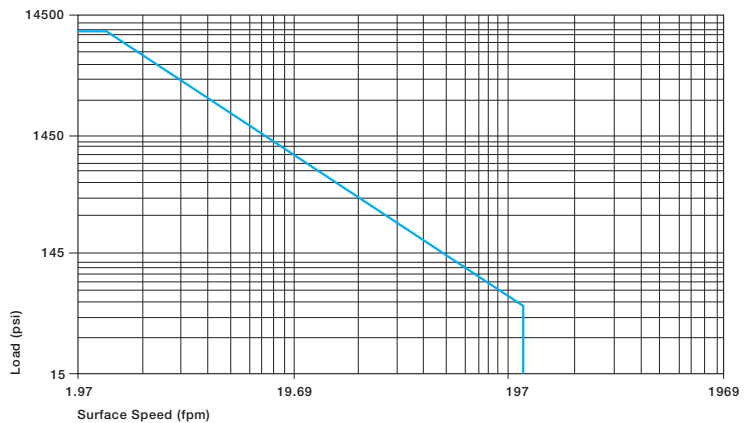

Graph 6.1: Permissible p x v - values for iglide® G300 running dry against a steel shaft, at 68°F

Compressive Strength

Picture 6.2 shows the elastic deformation of iglide® G300 during radial loading. At the maximum permissible load of 11,600 psi, the deformation is less than 5%. The plastic deformation is minimal up to a pressure of approximately 14,500 psi. However, it is also a result of the cycle time.

► Compressive Strength, Page 1.3

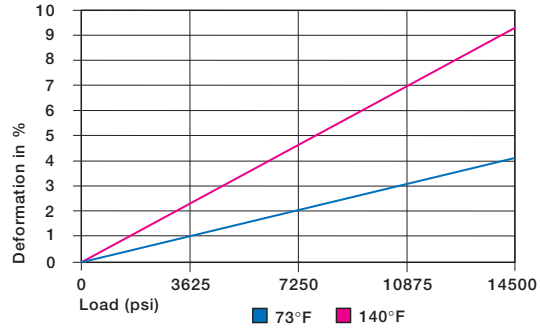

Graph 6.2: Deformation under load and temperature

Permissible Surface Speeds

iglide® G300 has been developed for low to medium surface speeds. The maximum values shown in Table 6.2 can only be achieved at low pressure loads. At the given speeds, friction can cause a temperature increase to maximum permissible levels. In practice, though, this temperature level is rarely reached, due to varying application conditions.

► Surface speed, Page 1.5
► p x v Value, Page 1.6

	Continuous fpm	Short Term fpm
Rotating	196	393
Oscillating	137	275
Linear	787	1043

Table 6.2: Maximum running speed

Temperatures

Application temperatures affect the properties of plain bearings greatly. The short-term maximum temperature is 428°F, this allows the use of iglide® G300 plain bearings in heat treating applications in which the bearings are not subjected to additional loading.

With increasing temperatures, the compressive strength of iglide® G300 plain bearings decreases. The graph 6.3 shows this inverse relationship. However, at the long-term maximum temperature of 266°F, the permissible surface pressure is still above 5,800 psi. The ambient temperatures that are prevalent in applications also has an effect on the bearing wear. With increasing temperatures, the wear increases and this effect is notable starting at the temperature of 248°F.

► Application Temperatures, Page 1.7

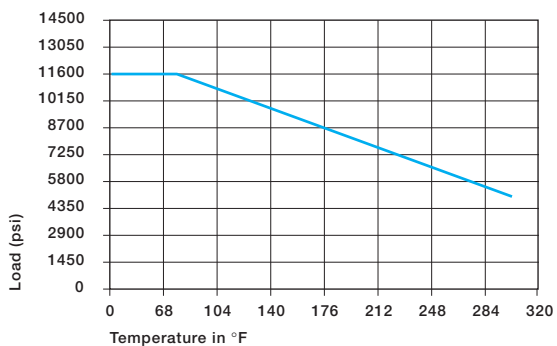

Graph 6.3: Recommended maximum permissible static surface pressure of iglide® G300 as a result of temperature

iglide® G300	Application Temperature
Minimum	- 40 °F
Max. long-term	+ 266 °F
Max. short-term	+ 428 °F

Table 6.3: Temperature limits for iglide® G300

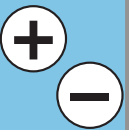

Installation Tolerances

iglide® G300 plain bearings are oversized before being pressfit. After proper installation into a recommended housing bore, the inner diameter adjusts to meet our specified tolerances. Please adhere to the catalog specifications for housing bore and recommended shaft sizes. This will help to ensure optimal performance of iglide® plain bearings.

- See Tolerance Table, Page 1.14
- Testing Methods, Page 1.15

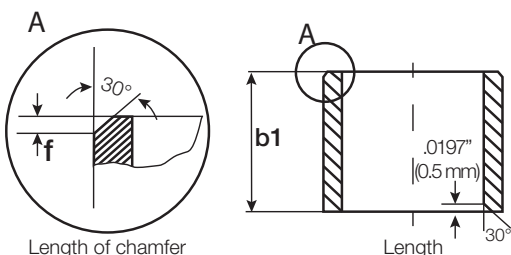

For Inch Size Bearings		
Length Tolerance (b1)		Length of Chamfer (f)
Length (inches)	Tolerance (h13) (inches)	Based on d1
0.1181 to 0.2362	-0.0000 /-0.0071	f = .012 → d ₁ .040" - .236"
0.2362 to 0.3937	-0.0000 /-0.0087	f = .019 → d ₁ > .236" - .472"
0.3937 to 0.7086	-0.0000 /-0.0106	f = .031 → d ₁ > .472" - 1.18"
0.7086 to 1.1811	-0.0000 /-0.0130	f = .047 → d ₁ > 1.18"
1.1811 to 1.9685	-0.0000 /-0.0154	
1.9685 to 3.1496	-0.0000 /-0.0181	

For Metric Size Bearings		
Length Tolerance (b1)		Length of Chamfer (f)
Length (mm)	Tolerance (h13) (µm)	Based on d1
1 to 3	-0 /-140	f = 0.3 → d ₁ 1 - 6 mm
> 3 to 6	-0 /-180	f = 0.5 → d ₁ > 6 - 12 mm
> 6 to 10	-0 /-220	f = 0.8 → d ₁ > 12 - 30 mm
> 10 to 18	-0 /-270	
> 18 to 30	-0 /-330	
> 30 to 50	-0 /-390	
> 50 to 80	-0 /-460	

Friction and Wear

Similar to wear resistance, the coefficient of friction μ also changes with the load. The coefficient of friction decreases with increasing loads, whereas an increase in surface speed causes an increase of the coefficient of friction. This relationship explains the excellent results of iglide® G300 plain bearings for high loads and low speeds (See Graph 6.4 and 6.5).

The friction and wear are also dependent, to a large degree, on the shaft partner. Shafts that are too smooth, increase both the coefficient of friction and the wear of the bearing. For iglide® G300, a ground surface with an average roughness Ra= 32 rms is recommended (See Graph 6.6).

- Coefficients of friction and surfaces, Page 1.8
- Wear Resistance, Page 1.9

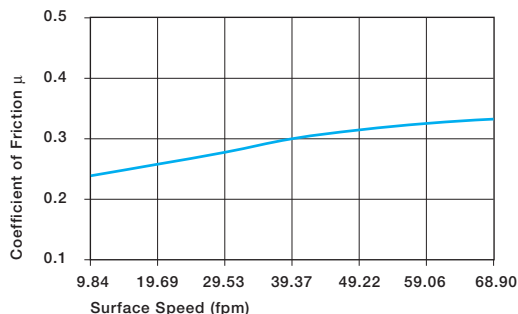

Graph 6.4: Coefficient of friction of iglide® G300 as a result of the running speed; p = 108 psi

iglide® G300	Coefficient of Friction
Dry	0.08 - 0.15
Grease	0.09
Oil	0.04
Water	0.04

Table 6.4: Coefficient of friction for iglide® G300 against steel (Shaft finish = 40 rms, 50 HRC)

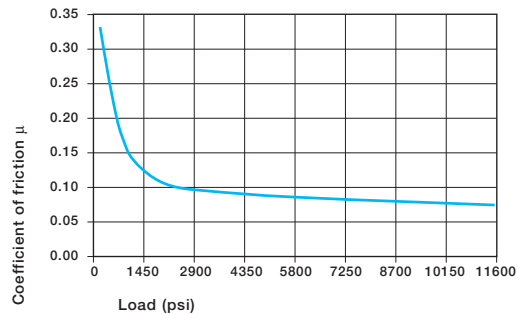

Graph 6.5: Coefficient of friction of iglide® G300 as a result of the load

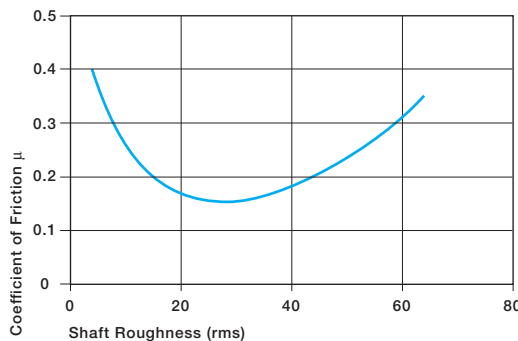

Graph 6.6: Coefficient of friction as result of the shaft surface (Shaft - Cold Rolled Steel)

Shaft Materials

Graph 6.7 and 6.8 show results of testing different shaft materials with plain bearings made of iglide® G300.

In Graph 6.7 it is observed that iglide® G300 can be combined with various shaft materials. The simple shaft materials of free-cutting steel and HR Carbon Steel have proven best at low loads. This helps to design cost-effective systems, since both iglide® G300 and the sliding partner are economically priced.

It is important to note that with increasing loads, the recommended hardness of the shaft increases. The “soft” shafts tend to wear more easily and thus increase the wear of the overall system. If the loads exceed 290 psi, it is important to recognize that the wear rate (the slope of the curves) clearly decreases with the hard shaft materials.

The comparison of rotational movements to oscillating movements shows that iglide® G300 can provide advantages in oscillating movements. The wear of the bearing is smaller for equivalent conditions. The higher the load, the larger the difference. This means that iglide® G300 can be used for oscillating movements that are well above the given maximum load of 11,600 psi. For these loads, the use of hardened shafts is recommended. In addition to the shaft materials presented here, many others have been tested. If the shaft material you plan on using is not contained in the test results presented here, please contact us.

► Shaft Materials, Page 1.11

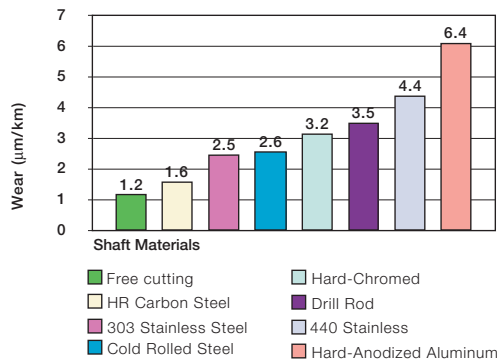

Graph 6.7: Wear of iglide® G300, rotating with different shaft materials, load p = 108 psi, v = 98 fpm

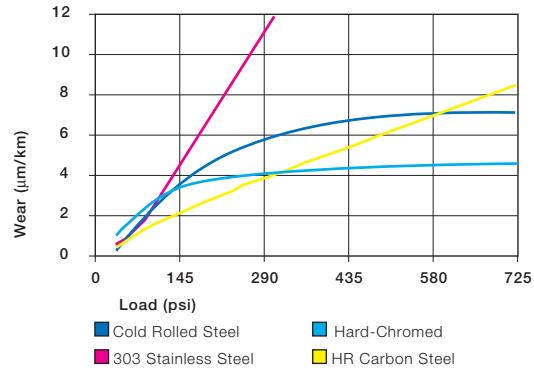

Graph 6.8: Wear with different shaft materials in rotational operation, as a result of the load

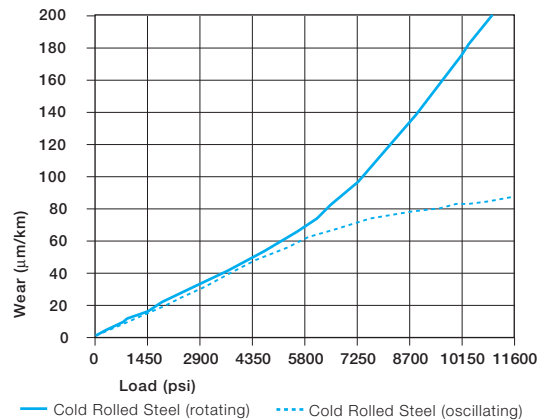

Graph 6.9: Wear for pivoting and rotating applications with shaft material Cold Rolled Steel 1018, as a result of the load

Chemical & Moisture Resistance

iglide® G300 plain bearings have strong resistance to chemicals. They are also resistant to most lubricants.

iglide® G300 plain bearings are not affected by most weak organic and inorganic acids.

The moisture absorption of iglide® G300 plain bearings is approximately 1% in the standard atmosphere. The saturation limit submerged in water is 4%. This must be taken into account for these types of applications.

► Chemicals Table, Page 1.16

Medium	Resistance
Alcohol	+ to 0
Hydrocarbon	+
Greases, oils without additives	+
Fuels	+
Weak acids	0 to -
Strong acids	-
Weak alkaline	+
Strong alkaline	0

+ resistant, 0 conditionally resistant, - not resistant

Table 6.5: Chemical resistance of iglide® G300

All data given concerns the chemical resistance at room temperature (68°F). For a complete list, see page 1.16

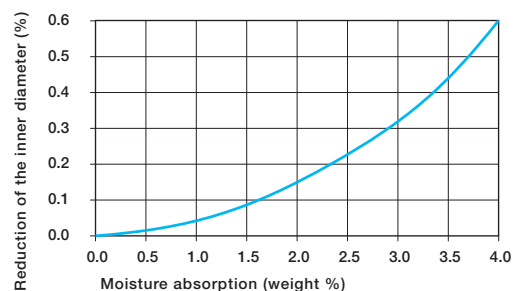

Graph 6.10: Effect of moisture absorption on iglide® G300 plain bearings



Radiation Resistance

Plain bearings made from iglide® G300 are resistant to radiation up to an intensity of 3×10^2 Gy.

UV Resistance

iglide® G300 plain bearings are permanently resistant to UV-radiation.

Vacuum

iglide® G300 plain bearings outgas in a vacuum. Use in a vacuum environment is only possible for dehumidified bearings.

Electrical Properties

iglide® G300 plain bearings are electrically insulating.

iglide® G300

Specific volume resistance	> 10^{13} Ωcm
Surface resistance	> 10^{11} Ω

Table 6.6: Electrical properties of iglide® G300

Application Examples



Reliable under high load, wear-resistant during continuous rotational use



Tested at a load of 4046 lbs for 10,000 cycles, resulted in no measurable wear



The pneumatic rotational drive unit in steam lines at temperatures up to 275°F



Vibrations, dirt, and temperatures up to 266°F characterize the area surrounding the engine



Conveyor chains: Through edge loading, short-term surface pressures of over 7,250 psi can occur



iglide® G300 plain bearings have proven themselves in control levers and pedals of farm tractors and construction vehicles

iglide® Plain Bearings G300 - Sleeve Bearing, Inch



G300

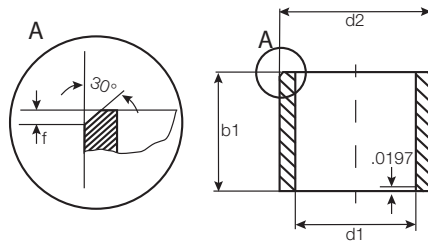

For tolerance values
please refer to page 6.4

iglide® G300
Sleeve - Inch

Part Number	d1	d2	b1	I.D. After Pressfit		Housing Bore		Shaft Size	
				Max.	Min.	Max.	Min.	Max.	Min.
GSI-0203-03	1/8	3/16	3/16	.1269	.1251	.1878	.1873	.1243	.1236
GSI-0203-04	1/8	3/16	1/4	.1269	.1251	.1878	.1873	.1243	.1236
GSI-0203-06	1/8	3/16	3/8	.1269	.1251	.1878	.1873	.1243	.1236
GSI-0304-04	3/16	1/4	1/4	.1892	.1873	.2503	.2497	.1865	.1858
GSI-0304-06	3/16	1/4	3/8	.1892	.1873	.2503	.2497	.1865	.1858
GSI-0304-08	3/16	1/4	1/2	.1892	.1873	.2503	.2497	.1865	.1858
GSI-0405-04	1/4	5/16	1/4	.2521	.2498	.3128	.3122	.2490	.2481
GSI-0405-05	1/4	5/16	5/16	.2521	.2498	.3128	.3122	.2490	.2481
GSI-0405-06	1/4	5/16	3/8	.2521	.2498	.3128	.3122	.2490	.2481
GSI-0405-08	1/4	5/16	1/2	.2521	.2498	.3128	.3122	.2490	.2481
GSI-0405-10	1/4	5/16	5/8	.2521	.2498	.3128	.3122	.2490	.2481
GSI-0405-12	1/4	5/16	3/4	.2521	.2498	.3128	.3122	.2490	.2481
GSI-0506-04	5/16	3/8	1/4	.3148	.3125	.3753	.3747	.3115	.3106
GSI-0506-06	5/16	3/8	3/8	.3148	.3125	.3753	.3747	.3115	.3106
GSI-0506-08	5/16	3/8	1/2	.3148	.3125	.3753	.3747	.3115	.3106
GSI-0506-12	5/16	3/8	3/4	.3148	.3125	.3753	.3747	.3115	.3106
GSI-0607-04	3/8	15/32	1/4	.3773	.3750	.4691	.4684	.3740	.3731
GSI-0607-06	3/8	15/32	3/8	.3773	.3750	.4691	.4684	.3740	.3731
GSI-0607-08	3/8	15/32	1/2	.3773	.3750	.4691	.4684	.3740	.3731
GSI-0607-12	3/8	15/32	3/4	.3773	.3750	.4691	.4684	.3740	.3731
GSI-0608-08	3/8	1/2	1/2	.3783	.3760	.5015	.5010	.3750	.3741
GSI-0608-12	3/8	1/2	3/4	.3783	.3760	.5015	.5010	.3750	.3741
GSI-0708-04	7/16	17/32	1/4	.4406	.4379	.5316	.5309	.4365	.4355
GSI-0708-08	7/16	17/32	1/2	.4406	.4379	.5316	.5309	.4365	.4355
GSI-0809-03	1/2	19/32	3/16	.5030	.5003	.5941	.5934	.4990	.4980
GSI-0809-04	1/2	19/32	1/4	.5030	.5003	.5941	.5934	.4990	.4980
GSI-0809-06	1/2	19/32	3/8	.5030	.5003	.5941	.5934	.4990	.4980
GSI-0809-08	1/2	19/32	1/2	.5030	.5003	.5941	.5934	.4990	.4980
GSI-0809-10	1/2	19/32	5/8	.5030	.5003	.5941	.5934	.4990	.4980
GSI-0809-12	1/2	19/32	3/4	.5030	.5003	.5941	.5934	.4990	.4980
GSI-0809-14	1/2	19/32	7/8	.5030	.5003	.5941	.5934	.4990	.4980
GSI-0809-16	1/2	19/32	1	.5030	.5003	.5941	.5934	.4990	.4980
GSI-0810-08	1/2	5/8	1/2	.5040	.5013	.6260	.6250	.5000	.4990
GSI-0810-12	1/2	5/8	3/4	.5040	.5013	.6260	.6250	.5000	.4990
GSI-0910-06	9/16	21/32	3/8	.5655	.5627	.6566	.6559	.5615	.5605
GSI-0910-08	9/16	21/32	1/2	.5655	.5627	.6566	.6559	.5615	.5605
GSI-0910-10	9/16	21/32	5/8	.5655	.5627	.6566	.6559	.5615	.5605
GSI-1011-06	5/8	23/32	3/8	.6280	.6253	.7192	.7184	.6240	.6230
GSI-1011-08	5/8	23/32	1/2	.6280	.6253	.7192	.7184	.6240	.6230
GSI-1011-10	5/8	23/32	5/8	.6280	.6253	.7192	.7184	.6240	.6230
GSI-1011-12	5/8	23/32	3/4	.6280	.6253	.7192	.7184	.6240	.6230
GSI-1011-16	5/8	23/32	1	.6280	.6253	.7192	.7184	.6240	.6230

PDF: www.igus.com/iglide-pdfs
CAD: www.igus.com/iglide-CAD
RoHS info: www.igus.com/RoHS

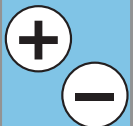

iglide® G300
Sleeve - Inch

Telephone 1-800-521-2747
Fax 1-401-438-7270

Internet: <http://www.igus.com>
email: sales@igus.com
QuickSpec: <http://www.igus.com/iglide-quickspec>

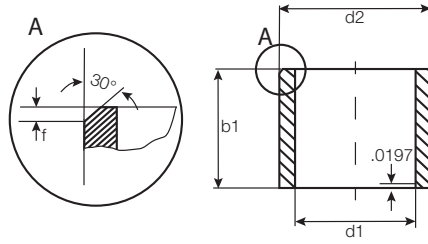

For tolerance values
please refer to page 6.4

Part Number	d1	d2	b1	I.D. After Pressfit		Housing Bore		Shaft Size	
				Max.	Min.	Max.	Min.	Max.	Min.
GSI-1011-20	5/8	23/32	1 1/4	.6280	.6253	.7192	.7184	.6240	.6230
GSI-1011-30	5/8	23/32	1 7/8	.6280	.6253	.7192	.7184	.6240	.6230
GSI-1012-08	5/8	3/4	1/2	.6280	.6253	.7508	.7500	.6250	.6233
GSI-1012-16	5/8	3/4	1	.6280	.6253	.7508	.7500	.6250	.6233
GSI-1112-14	11/16	25/32	7/8	.6906	.6879	.7817	.7809	.6865	.6855
GSI-1214-02	3/4	7/8	1/8	.7541	.7508	.8755	.8747	.7491	.7479
GSI-1214-06	3/4	7/8	3/8	.7541	.7508	.8755	.8747	.7491	.7479
GSI-1214-08	3/4	7/8	1/2	.7541	.7508	.8755	.8747	.7491	.7479
GSI-1214-12	3/4	7/8	3/4	.7541	.7508	.8755	.8747	.7491	.7479
GSI-1214-16	3/4	7/8	1	.7541	.7508	.8755	.8747	.7491	.7479
GSI-1214-20	3/4	7/8	1 1/4	.7541	.7508	.8755	.8747	.7491	.7479
GSI-1214-24	3/4	7/8	1 1/2	.7541	.7508	.8755	.8747	.7491	.7479
GSI-1416-06	7/8	1	3/8	.8791	.8757	1.0005	.9997	.8741	.8729
GSI-1416-08	7/8	1	1/2	.8791	.8757	1.0005	.9997	.8741	.8729
GSI-1416-10	7/8	1	5/8	.8791	.8757	1.0005	.9997	.8741	.8729
GSI-1416-12	7/8	1	3/4	.8791	.8757	1.0005	.9997	.8741	.8729
GSI-1416-16	7/8	1	1	.8791	.8757	1.0005	.9997	.8741	.8729
GSI-1416-24	7/8	1	1 1/2	.8791	.8757	1.0005	.9997	.8741	.8729
GSI-1618-08	1	1 1/8	1/2	1.0041	1.0007	1.1255	1.1247	.9991	.9979
GSI-1618-12	1	1 1/8	3/4	1.0041	1.0007	1.1255	1.1247	.9991	.9979
GSI-1618-16	1	1 1/8	1	1.0041	1.0007	1.1255	1.1247	.9991	.9979
GSI-1618-20	1	1 1/8	1 1/4	1.0041	1.0007	1.1255	1.1247	.9991	.9979
GSI-1618-24	1	1 1/8	1 1/2	1.0041	1.0007	1.1255	1.1247	.9991	.9979
GSI-1618-33	1	1 1/8	2 1/16	1.0041	1.0007	1.1255	1.1247	.9991	.9979
GSI-1820-12	1 1/8	1 9/32	3/4	1.1288	1.1254	1.2818	1.2808	1.1238	1.1226
GSI-1820-20	1 1/8	1 9/32	1 1/4	1.1288	1.1254	1.2818	1.2808	1.1238	1.1226
GSI-1820-24	1 1/8	1 9/32	1 1/2	1.1288	1.1254	1.2818	1.2808	1.1238	1.1226
GSI-2022-12	1 1/4	1 13/32	3/4	1.2548	1.2508	1.4068	1.4058	1.2488	1.2472
GSI-2022-14	1 1/4	1 13/32	7/8	1.2548	1.2508	1.4068	1.4058	1.2488	1.2472
GSI-2022-16	1 1/4	1 13/32	1	1.2548	1.2508	1.4068	1.4058	1.2488	1.2472
GSI-2022-20	1 1/4	1 13/32	1 1/4	1.2548	1.2508	1.4068	1.4058	1.2488	1.2472
GSI-2022-24	1 1/4	1 13/32	1 1/2	1.2548	1.2508	1.4068	1.4058	1.2488	1.2472
GSI-2224-16	1 3/8	1 17/32	1	1.3798	1.3758	1.5318	1.5308	1.3738	1.3722
GSI-2224-24	1 3/8	1 17/32	1 1/2	1.3798	1.3758	1.5318	1.5308	1.3738	1.3722
GSI-2224-26	1 3/8	1 17/32	1 5/8	1.3798	1.3758	1.5318	1.5308	1.3738	1.3722
GSI-2426-06	1 1/2	1 21/32	3/8	1.5048	1.5008	1.6568	1.6558	1.4988	1.4972
GSI-2426-07	1 1/2	1 21/32	7/16	1.5048	1.5008	1.6568	1.6558	1.4988	1.4972
GSI-2426-08	1 1/2	1 21/32	1/2	1.5048	1.5008	1.6568	1.6558	1.4988	1.4972
GSI-2426-12	1 1/2	1 21/32	3/4	1.5048	1.5008	1.6568	1.6558	1.4988	1.4972
GSI-2426-16	1 1/2	1 21/32	1	1.5048	1.5008	1.6568	1.6558	1.4988	1.4972

iglide® Plain Bearings G300 - Sleeve Bearing, Inch

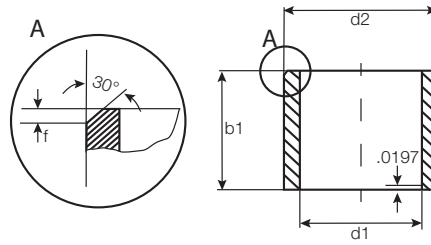

For tolerance values
please refer to page 6.4

iglide® G300
Sleeve - Inch

Part Number	d1	d2	b1	I.D. After Pressfit		Housing Bore		Shaft Size	
				Max.	Min.	Max.	Min.	Max.	Min.
GSI-2426-24	1 1/2	1 21/32	1 1/2	1.5048	1.5008	1.6568	1.6558	1.4988	1.4972
GSI-2629-14	1 5/8	1 25/32	7/8	1.6297	1.6258	1.7818	1.7808	1.6238	1.6222
GSI-2629-20	1 5/8	1 25/32	1 1/4	1.6297	1.6258	1.7818	1.7808	1.6238	1.6222
GSI-2831-16	1 3/4	1 15/16	1	1.7547	1.7508	1.9381	1.9371	1.7487	1.7471
GSI-2831-24	1 3/4	1 15/16	1 1/2	1.7547	1.7508	1.9381	1.9371	1.7487	1.7471
GSI-2831-32	1 3/4	1 15/16	2	1.7547	1.7508	1.9381	1.9371	1.7487	1.7471
GSI-2831-40	1 3/4	1 15/16	2 1/2	1.7547	1.7508	1.9381	1.9371	1.7487	1.7471
GSI-2831-48	1 3/4	1 15/16	3	1.7547	1.7508	1.9381	1.9371	1.7487	1.7471
GSI-3235-16	2	2 3/16	1	2.0059	2.0012	2.1883	2.1871	1.9981	1.9969
GSI-3235-24	2	2 3/16	1 1/2	2.0059	2.0012	2.1883	2.1871	1.9981	1.9969
GSI-3235-32	2	2 3/16	2	2.0059	2.0012	2.1883	2.1871	1.9981	1.9969
GSI-3639-32	2 1/4	2 7/16	2	2.2577	2.2531	2.4377	2.4365	2.2507	2.2489
GSI-4043-32	2 2/4	2 11/16	2	2.5082	2.5035	2.6881	2.6869	2.5000	2.4971
GSI-4447-32	2 3/4	2 15/16	2	2.7570	2.7523	2.9370	2.9358	2.7500	2.7471
GSI-4851-32	3	3 3/16	2	3.0070	3.0023	3.1872	3.1858	3.0000	2.9971

PDF: www.igus.com/iglide-pdfs
 CAD: www.igus.com/iglide-CAD
 RoHS info: www.igus.com/RoHS

Navigation icons: +, |, i, inch, mm



iglide® Plain Bearings G300 - Flange Bearing, Inch

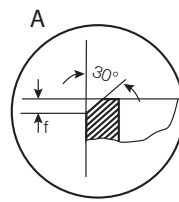

$r = \text{max. } .0197$

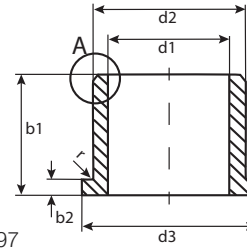

For tolerance values
please refer to page 6.4

iglide® G300
Flange - Inch

Telephone 1-800-521-2747
Fax 1-401-438-7270

Internet: <http://www.igus.com>
email: sales@igus.com
QuickSpec: <http://www.igus.com/iglide-quickspec>

Part Number	d1	d2	b1	d3	b2	I.D. After Pressfit		Housing Bore		Shaft Size	
						Max.	Min.	Max.	Min.	Max.	Min.
GFI-0203-02	1/8	3/16	1/8	.312	.032	.1269	.1251	.1878	.1873	.1243	.1236
GFI-0203-03	1/8	3/16	3/16	.312	.032	.1269	.1251	.1878	.1873	.1243	.1236
GFI-0203-04	1/8	3/16	1/4	.312	.032	.1269	.1251	.1878	.1873	.1243	.1236
GFI-0203-06	1/8	3/16	3/8	.312	.032	.1269	.1251	.1878	.1873	.1243	.1236
GFI-0304-04	3/16	1/4	1/4	.375	.032	.1892	.1873	.2503	.2497	.1865	.1858
GFI-0304-06	3/16	1/4	3/8	.375	.032	.1892	.1873	.2503	.2497	.1865	.1858
GFI-0304-08	3/16	1/4	1/2	.375	.032	.1892	.1873	.2503	.2497	.1865	.1858
GFI-0405-2.4	1/4	5/16	5/32	.500	.032	.2521	.2498	.3128	.3122	.2490	.2481
GFI-0405-04	1/4	5/16	1/4	.500	.032	.2521	.2498	.3128	.3122	.2490	.2481
GFI-0405-05	1/4	5/16	5/16	.500	.032	.2521	.2498	.3128	.3122	.2490	.2481
GFI-0405-06	1/4	5/16	3/8	.500	.032	.2521	.2498	.3128	.3122	.2490	.2481
GFI-0405-08	1/4	5/16	1/2	.500	.032	.2521	.2498	.3128	.3122	.2490	.2481
GFI-0405-12	1/4	5/16	3/4	.500	.032	.2521	.2498	.3128	.3122	.2490	.2481
GFI-0506-03	5/16	3/8	3/16	.562	.032	.3148	.3125	.3753	.3747	.3115	.3106
GFI-0506-04	5/16	3/8	1/4	.562	.032	.3148	.3125	.3753	.3747	.3115	.3106
GFI-0506-06	5/16	3/8	3/8	.562	.032	.3148	.3125	.3753	.3747	.3115	.3106
GFI-0506-08	5/16	3/8	1/2	.562	.032	.3148	.3125	.3753	.3747	.3115	.3106
GFI-0506-12	5/16	3/8	3/4	.562	.032	.3148	.3125	.3753	.3747	.3115	.3106
GFI-0607-04	3/8	15/32	1/4	.687	.046	.3773	.3750	.4691	.4684	.3740	.3731
GFI-0607-05	3/8	15/32	5/16	.687	.046	.3773	.3750	.4691	.4684	.3740	.3731
GFI-0607-06	3/8	15/32	3/8	.687	.046	.3773	.3750	.4691	.4684	.3740	.3731
GFI-0607-08	3/8	15/32	1/2	.687	.046	.3773	.3750	.4691	.4684	.3740	.3731
GFI-0607-12	3/8	15/32	3/4	.687	.046	.3773	.3750	.4691	.4684	.3740	.3731
GFI-0607-14	3/8	15/32	7/8	.687	.046	.3773	.3750	.4691	.4684	.3740	.3731
GFI-0708-04	7/16	17/32	1/4	.750	.046	.4406	.4379	.5316	.5309	.4365	.4355
GFI-0708-08	7/16	17/32	1/2	.750	.046	.4406	.4379	.5316	.5309	.4365	.4355
GFI-0809-02	1/2	19/32	1/8	.875	.046	.5030	.5003	.5941	.5934	.4990	.4980
GFI-0809-04	1/2	19/32	1/4	.875	.046	.5030	.5003	.5941	.5934	.4990	.4980
GFI-0809-05	1/2	19/32	5/16	.875	.046	.5030	.5003	.5941	.5934	.4990	.4980
GFI-0809-06	1/2	19/32	3/8	.875	.046	.5030	.5003	.5941	.5934	.4990	.4980
GFI-0809-08	1/2	19/32	1/2	.875	.046	.5030	.5003	.5941	.5934	.4990	.4980
GFI-0809-12	1/2	19/32	3/4	.875	.046	.5030	.5003	.5941	.5934	.4990	.4980
GFI-0809-16	1/2	19/32	1	.875	.046	.5030	.5003	.5941	.5934	.4990	.4980
GFI-1011-06	5/8	23/32	3/8	.937	.046	.6280	.6253	.7192	.7184	.6240	.6230
GFI-1011-08	5/8	23/32	1/2	.937	.046	.6280	.6253	.7192	.7184	.6240	.6230
GFI-1011-12	5/8	23/32	3/4	.937	.046	.6280	.6253	.7192	.7184	.6240	.6230
GFI-1011-14	5/8	23/32	7/8	.937	.046	.6280	.6253	.7192	.7184	.6240	.6230
GFI-1011-16	5/8	23/32	1	.937	.046	.6280	.6253	.7192	.7184	.6240	.6230
GFI-1011-24	5/8	23/32	1 1/2	.937	.046	.6280	.6253	.7192	.7184	.6240	.6230
GFI-1214-02	3/4	7/8	1/8	1.125	.062	.7541	.7508	.8755	.8747	.7491	.7479
GFI-1214-06	3/4	7/8	3/8	1.125	.062	.7541	.7508	.8755	.8747	.7491	.7479

iglide® Plain Bearings G300 - Flange Bearing, Inch



G300

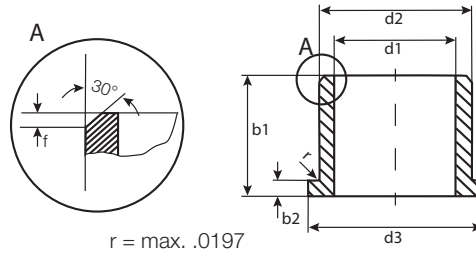

For tolerance values
please refer to page 6.4

iglide® G300
Flange - Inch

Part Number	d1	d2	b1	d3	b2	I.D. After Pressfit		Housing Bore		Shaft Size	
						-.0055 Max.	Min.	Max.	Min.	Max.	Min.
GFI-1214-08	3/4	7/8	1/2	1.125	.062	.7541	.7508	.8755	.8747	.7491	.7479
GFI-1214-10	3/4	7/8	5/8	1.125	.062	.7541	.7508	.8755	.8747	.7491	.7479
GFI-1214-12	3/4	7/8	3/4	1.125	.062	.7541	.7508	.8755	.8747	.7491	.7479
GFI-1214-16	3/4	7/8	1	1.125	.062	.7541	.7508	.8755	.8747	.7491	.7479
GFI-1214-24	3/4	7/8	1 1/2	1.125	.062	.7541	.7508	.8755	.8747	.7491	.7479
GFI-1416-08	7/8	1	1/2	1.250	.062	.8791	.8757	1.0005	.9997	.8741	.8729
GFI-1416-12	7/8	1	3/4	1.250	.062	.8791	.8757	1.0005	.9997	.8741	.8729
GFI-1416-16	7/8	1	1	1.250	.062	.8791	.8757	1.0005	.9997	.8741	.8729
GFI-1416-20	7/8	1	1 1/4	1.250	.062	.8791	.8757	1.0005	.9997	.8741	.8729
GFI-1416-24	7/8	1	1 1/2	1.250	.062	.8791	.8757	1.0005	.9997	.8741	.8729
GFI-1618-08	1	1 1/8	1/2	1.375	.062	1.0041	1.0007	1.1255	1.1247	.9991	.9979
GFI-1618-12	1	1 1/8	3/4	1.375	.062	1.0041	1.0007	1.1255	1.1247	.9991	.9979
GFI-1618-16	1	1 1/8	1	1.375	.062	1.0041	1.0007	1.1255	1.1247	.9991	.9979
GFI-1618-20	1	1 1/8	1 1/4	1.375	.062	1.0041	1.0007	1.1255	1.1247	.9991	.9979
GFI-1618-24	1	1 1/8	1 1/2	1.375	.062	1.0041	1.0007	1.1255	1.1247	.9991	.9979
GFI-1820-12	1 1/8	1 9/32	3/4	1.562	.078	1.1288	1.1254	1.2818	1.2808	1.1238	1.1226
GFI-1820-24	1 1/8	1 9/32	1 1/2	1.562	.078	1.1288	1.1254	1.2818	1.2808	1.1238	1.1226
GFI-2022-06	1 1/4	1 13/32	3/8	1.687	.078	1.2548	1.2508	1.4068	1.4058	1.2488	1.2472
GFI-2022-12	1 1/4	1 13/32	3/4	1.687	.078	1.2548	1.2508	1.4068	1.4058	1.2488	1.2472
GFI-2022-14	1 1/4	1 13/32	7/8	1.687	.078	1.2548	1.2508	1.4068	1.4058	1.2488	1.2472
GFI-2022-16	1 1/4	1 13/32	1	1.687	.078	1.2548	1.2508	1.4068	1.4058	1.2488	1.2472
GFI-2022-20	1 1/4	1 13/32	1 1/4	1.687	.078	1.2548	1.2508	1.4068	1.4058	1.2488	1.2472
GFI-2022-24	1 1/4	1 13/32	1 1/2	1.687	.078	1.2548	1.2508	1.4068	1.4058	1.2488	1.2472
GFI-2224-16	1 3/8	1 17/32	1	1.875	.078	1.3798	1.3758	1.5318	1.5308	1.3738	1.3722
GFI-2426-12	1 1/2	1 21/32	3/4	2.000	.078	1.5048	1.5008	1.6568	1.6558	1.4988	1.4972
GFI-2426-16	1 1/2	1 21/32	1	2.000	.078	1.5048	1.5008	1.6568	1.6558	1.4988	1.4972
GFI-2426-24	1 1/2	1 21/32	1 1/2	2.000	.078	1.5048	1.5008	1.6568	1.6558	1.4988	1.4972
GFI-2831-16	1 3/4	1 15/16	1	2.375	.093	1.7547	1.7508	1.9381	1.9371	1.7487	1.7471
GFI-2831-24	1 3/4	1 15/16	1 1/2	2.375	.093	1.7547	1.7508	1.9381	1.9371	1.7487	1.7471
GFI-2831-32	1 3/4	1 15/16	2	2.375	.093	1.7547	1.7508	1.9381	1.9371	1.7487	1.7471
GFI-3235-16	2	2 3/16	1	2.625	.093	2.0059	2.0012	2.1883	2.1871	1.9981	1.9969
GFI-3235-24	2	2 3/16	1 1/2	2.625	.093	2.0059	2.0012	2.1883	2.1871	1.9981	1.9969
GFI-3235-32	2	2 3/16	2	2.625	.093	2.0059	2.0012	2.1883	2.1871	1.9981	1.9969
GFI-3639-32	2 1/4	2 7/16	2	2.750	.093	2.2577	2.2531	2.4377	2.4365	2.2507	2.2489
GFI-4043-32	2 1/2	2 11/16	2	3.125	.093	2.5082	2.5035	2.6881	2.6869	2.5000	2.4971
GFI-4447-32	2 3/4	2 15/16	2	3.375	.093	2.7570	2.7523	2.9370	2.9358	2.7500	2.7471

PDF: www.igus.com/iglide-pdfs
CAD: www.igus.com/iglide-CAD
RoHS info: www.igus.com/RoHS





iglide® Plain Bearings
G300 - Thrust Washer, Inch

iglide® G300
Thrust Washer - Inch

Telephone 1-800-521-2747
Fax 1-401-438-7270

Internet: <http://www.igus.com>
email: sales@igus.com
QuickSpec: <http://www.igus.com/iglide-quickspec>

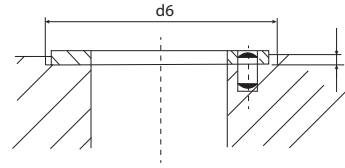
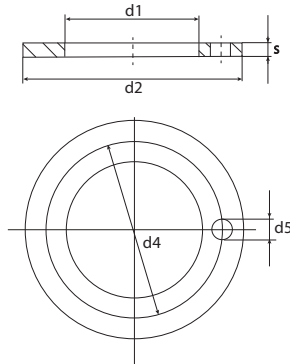

Part Number	d1 +.010	d2 -.010	s -.0020	d4 +-.005	d5 .015 +.005	h +.008	d6 +.005
GTI-0610-01	.375	.625	.040				.375
GTI-0814-01	.500	.875	.0585	.692	.067	.040	.875
GTI-1018-01	.625	1.125	.0585	.880	.099	.040	1.125
GTI-1220-01	.750	1.250	.0585	1.005	.099	.040	1.250
GTI-1424-01	.875	1.500	.0585	1.192	.130	.040	1.500
GTI-1628-01	1.000	1.750	.0585	1.380	.130	.040	1.750
GTI-2034-01	1.250	2.125	.0585	1.692	.161	.040	2.125
GTI-2440-01	1.500	2.500	.0585	2.005	.192	.040	2.500
GTI-2844-01	1.750	2.750	.0585	2.255	.192	.040	2.750
GTI-3248-01	2.000	3.000	.0895	2.505	.192	.070	3.000

iglide® Plain Bearings G300 - Sleeve Bearing, MM



G300

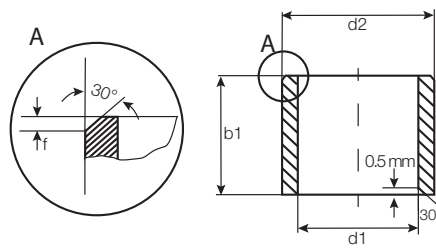

For tolerance values
please refer to page 6.4

Dimensions according to ISO 3547-1 and special dimensions

Part Number	d1		d2	b1 h13	I.D. After Pressfit		Housing Bore		Shaft Size	
	after pressfit in Ø H7				Max.	Min.	Max.	Min.	Max.	Min.
GSM-0103-02	1.5	+0.014 +0.054	3.0	2.0	1.554	1.514	3.008	3.000	1.500	1.475
GSM-0203-03	2.0	+0.014 +0.054	3.5	3.0	2.054	2.014	3.508	3.500	2.000	1.975
GSM-02504-05	2.5	+0.014 +0.054	4.5	5.0	2.554	2.514	4.508	4.500	2.500	2.475
GSM-0304-03	3.0	+0.014 +0.054	4.5	3.0	3.054	3.014	4.512	4.500	3.000	2.975
GSM-0304-05	3.0	+0.014 +0.054	4.5	5.0	3.054	3.014	4.512	4.500	3.000	2.975
GSM-0304-06	3.0	+0.014 +0.054	4.5	6.0	3.054	3.014	4.512	4.500	3.000	2.975
GSM-0304-16	3.0	+0.014 +0.054	4.5	16.0	3.054	3.014	4.512	4.500	3.000	2.975
GSM-0405-04	4.0	+0.020 +0.068	5.5	4.0	4.068	4.020	5.512	5.500	4.000	3.970
GSM-0405-06	4.0	+0.020 +0.068	5.5	6.0	4.068	4.020	5.512	5.500	4.000	3.970
GSM-0406-08	4.5	+0.020 +0.068	6.0	8.0	4.568	4.520	6.012	6.000	4.500	4.470
GSM-0407-05	4.0	+0.020 +0.068	7.0	5.0	4.068	4.020	7.015	7.000	4.000	3.970
GSM-0407-055	4.0	+0.020 +0.068	7.0	5.5	4.068	4.020	7.015	7.000	4.000	3.970
GSM-0506-046	5.0	+0.010 +0.040	6.0	4.6	5.040	5.010	6.012	6.000	5.000	4.970
GSM-0506-05	5.0	+0.010 +0.040	6.0	5.0	5.040	5.010	6.012	6.000	5.000	4.970
GSM-0506-07	5.0	+0.010 +0.040	6.0	7.0	5.040	5.010	6.012	6.000	5.000	4.970
GSM-0507-05	5.0	+0.020 +0.068	7.0	5.0	5.068	5.020	7.015	7.000	5.000	4.970
GSM-0507-08	5.0	+0.020 +0.068	7.0	8.0	5.068	5.020	7.015	7.000	5.000	4.970
GSM-0507-10	5.0	+0.020 +0.068	7.0	10.0	5.068	5.020	7.015	7.000	5.000	4.970
GSM-0607-06	6.0	+0.010 +0.040	7.0	6.0	6.040	6.010	7.015	7.000	6.000	5.970
GSM-0607-12	6.0	+0.010 +0.040	7.0	12.0	6.040	6.010	7.015	7.000	6.000	5.970
GSM-0607-17.5	6.0	+0.010 +0.040	7.0	17.5	6.040	6.010	7.015	7.000	6.000	5.970
GSM-0608-025	6.0	+0.020 +0.068	8.0	2.5	6.068	6.020	8.015	8.000	6.000	5.970
GSM-0608-04	6.0	+0.020 +0.068	8.0	4.0	6.068	6.020	8.015	8.000	6.000	5.970
GSM-0608-05	6.0	+0.020 +0.068	8.0	5.0	6.068	6.020	8.015	8.000	6.000	5.970
GSM-0608-055	6.0	+0.020 +0.068	8.0	5.5	6.068	6.020	8.015	8.000	6.000	5.970
GSM-0608-06	6.0	+0.020 +0.068	8.0	6.0	6.068	6.020	8.015	8.000	6.000	5.970
GSM-0608-08	6.0	+0.020 +0.068	8.0	8.0	6.068	6.020	8.015	8.000	6.000	5.970
GSM-0608-09	6.0	+0.020 +0.068	8.0	9.5	6.068	6.020	8.015	8.000	6.000	5.970
GSM-0608-10	6.0	+0.020 +0.068	8.0	10.0	6.068	6.020	8.015	8.000	6.000	5.970
GSM-0608-11	6.0	+0.020 +0.068	8.0	11.8	6.068	6.020	8.015	8.000	6.000	5.970
GSM-0608-13	6.0	+0.020 +0.068	8.0	13.8	6.068	6.020	8.015	8.000	6.000	5.970
GSM-0708-10	7.0	+0.013 +0.049	8.0	10.0	7.049	7.013	8.015	8.000	7.000	6.964
GSM-0708-19	7.0	+0.013 +0.049	8.0	19.0	7.049	7.013	8.015	8.000	7.000	6.964
GSM-0709-05	7.0	+0.025 +0.083	9.0	5.0	7.083	7.025	9.015	9.000	7.000	6.964
GSM-0709-08	7.0	+0.025 +0.083	9.0	8.0	7.083	7.025	9.015	9.000	7.000	6.964
GSM-0709-09	7.0	+0.025 +0.083	9.0	9.0	7.083	7.025	9.015	9.000	7.000	6.964
GSM-0709-10	7.0	+0.025 +0.083	9.0	10.0	7.083	7.025	9.015	9.000	7.000	6.694
GSM-0709-12	7.0	+0.025 +0.083	9.0	12.0	7.083	7.025	9.015	9.000	7.000	6.694
GSM-0809-05	8.0	+0.013 +0.049	9.0	5.0	8.049	8.013	9.015	9.000	8.000	7.964
GSM-0809-06	8.0	+0.013 +0.049	9.0	6.0	8.049	8.013	9.015	9.000	8.000	7.964
GSM-0809-08	8.0	+0.013 +0.049	9.0	8.0	8.049	8.013	9.015	9.000	8.000	7.964

iglide® G300
Sleeve - MM

PDF: www.igus.com/iglide-pdfs
CAD: www.igus.com/iglide-CAD
RoHS info: www.igus.com/RoHS



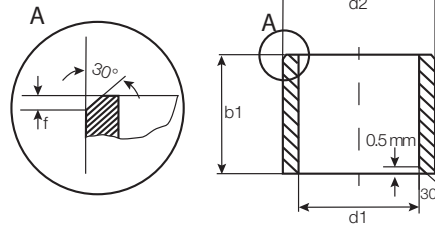

For tolerance values
please refer to page 6.4

Dimensions according to ISO 3547-1 and special dimensions

Part Number	d1	d1-Tolerance after pressfit in Ø H7	d2	b1 h13	I.D. After Pressfit		Housing Bore		Shaft Size	
					Max.	Min.	Max.	Min.	Max.	Min.
GSM-0809-12	8.0	+0.013 +0.049	9.0	12.0	8.049	8.013	9.015	9.000	8.000	7.964
GSM-0810-05	8.0	+0.025 +0.083	10.0	5.0	8.083	8.025	10.015	10.000	8.000	7.964
GSM-0810-06	8.0	+0.025 +0.083	10.0	6.0	8.083	8.025	10.015	10.000	8.000	7.964
GSM-0810-07	8.0	+0.025 +0.083	10.0	7.0	8.083	8.025	10.015	10.000	8.000	7.964
GSM-0810-08	8.0	+0.025 +0.083	10.0	8.0	8.083	8.025	10.015	10.000	8.000	7.964
GSM-0810-10	8.0	+0.025 +0.083	10.0	10.0	8.083	8.025	10.015	10.000	8.000	7.964
GSM-0810-12	8.0	+0.025 +0.083	10.0	12.0	8.083	8.025	10.015	10.000	8.000	7.964
GSM-0810-13	8.0	+0.025 +0.083	10.0	13.0	8.083	8.025	10.015	10.000	8.000	7.964
GSM-0810-15	8.0	+0.025 +0.083	10.0	15.0	8.083	8.025	10.015	10.000	8.000	7.964
GSM-0810-16	8.0	+0.025 +0.083	10.0	16.0	8.083	8.025	10.015	10.000	8.000	7.964
GSM-0810-20	8.0	+0.025 +0.083	10.0	20.0	8.083	8.025	10.015	10.000	8.000	7.964
GSM-0810-22	8.0	+0.025 +0.083	10.0	22.0	8.083	8.025	10.015	10.000	8.000	7.964
GSM-0911-06	9.0	+0.025 +0.083	11.0	6.0	9.083	9.025	11.018	11.000	9.000	8.964
GSM-1011-06	10.0	+0.013 +0.049	11.0	6.0	10.049	10.013	11.018	11.000	10.000	9.964
GSM-1011-10	10.0	+0.013 +0.049	11.0	10.0	10.049	10.013	11.018	11.000	10.000	9.964
GSM-1011-20	10.0	+0.013 +0.049	11.0	20.0	10.049	10.013	11.018	11.000	10.000	9.964
GSM-1011-25	10.0	+0.013 +0.049	11.0	25.0	10.049	10.013	11.018	11.000	10.000	9.964
GSM-1011-30	10.0	+0.013 +0.049	11.0	30.0	10.049	10.013	11.018	11.000	10.000	9.964
GSM-1012-04	10.0	+0.025 +0.083	12.0	4.0	10.083	10.025	12.018	12.000	10.000	9.964
GSM-1012-045	10.0	+0.025 +0.083	12.0	4.5	10.083	10.025	12.018	12.000	10.000	9.964
GSM-1012-05	10.0	+0.025 +0.083	12.0	5.0	10.083	10.025	12.018	12.000	10.000	9.964
GSM-1012-06	10.0	+0.025 +0.083	12.0	6.0	10.083	10.025	12.018	12.000	10.000	9.964
GSM-1012-07	10.0	+0.025 +0.083	12.0	7.0	10.083	10.025	12.018	12.000	10.000	9.964
GSM-1012-08	10.0	+0.025 +0.083	12.0	8.0	10.083	10.025	12.018	12.000	10.000	9.964
GSM-1012-09	10.0	+0.025 +0.083	12.0	9.0	10.083	10.025	12.018	12.000	10.000	9.964
GSM-1012-10	10.0	+0.025 +0.083	12.0	10.0	10.083	10.025	12.018	12.000	10.000	9.964
GSM-1012-12	10.0	+0.025 +0.083	12.0	12.0	10.083	10.025	12.018	12.000	10.000	9.964
GSM-1012-14	10.0	+0.025 +0.083	12.0	14.0	10.083	10.025	12.018	12.000	10.000	9.964
GSM-1012-15	10.0	+0.025 +0.083	12.0	15.0	10.083	10.025	12.018	12.000	10.000	9.964
GSM-1012-17	10.0	+0.025 +0.083	12.0	17.0	10.083	10.025	12.018	12.000	10.000	9.964
GSM-1012-20	10.0	+0.025 +0.083	12.0	20.0	10.083	10.025	12.018	12.000	10.000	9.964
GSM-1013-13	10.0	+0.025 +0.083	13.0	13.5	10.083	10.025	13.018	13.000	10.000	9.964
GSM-1014-10	10.0	+0.025 +0.083	14.0	10.0	10.083	10.025	14.018	14.000	10.000	9.964
GSM-1014-20	10.0	+0.025 +0.083	14.0	20.0	10.083	10.025	14.018	14.000	10.000	9.964
GSM-1213-047	12.0	+0.016 +0.059	13.0	4.7	12.059	12.016	13.018	13.000	12.000	11.957
GSM-1213-10	12.0	+0.016 +0.059	13.0	10.0	12.059	12.016	13.018	13.000	12.000	11.957
GSM-1213-12	12.0	+0.016 +0.059	13.0	12.0	12.059	12.016	13.018	13.000	12.000	11.957
GSM-1213-15	12.0	+0.016 +0.059	13.0	15.0	12.059	12.016	13.018	13.000	12.000	11.957
GSM-1214-04	12.0	+0.032 +0.102	14.0	4.0	12.102	12.032	14.018	14.000	12.000	11.957
GSM-1214-05	12.0	+0.032 +0.102	14.0	5.0	12.102	12.032	14.018	14.000	12.000	11.957

iglide® Plain Bearings

G300 - Sleeve Bearing, MM

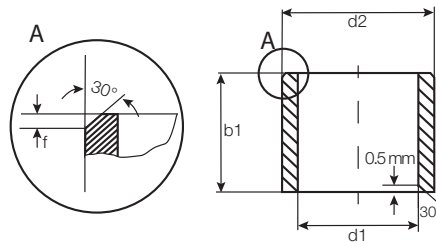

For tolerance values
please refer to page 6.4

Dimensions according to ISO 3547-1 and special dimensions

Part Number	d1		d2	b1 h13	I.D. After Pressfit		Housing Bore		Shaft Size	
	after pressfit in Ø H7				Max.	Min.	Max.	Min.	Max.	Min.
GSM-1214-06	12.0	+0.032 +0.102	14.0	6.0	12.102	12.032	14.018	14.000	12.000	11.957
GSM-1214-08	12.0	+0.032 +0.102	14.0	8.0	12.102	12.032	14.018	14.000	12.000	11.957
GSM-1214-10	12.0	+0.032 +0.102	14.0	10.0	12.102	12.032	14.018	14.000	12.000	11.957
GSM-1214-12	12.0	+0.032 +0.102	14.0	12.0	12.102	12.032	14.018	14.000	12.000	11.957
GSM-1214-14	12.0	+0.032 +0.102	14.0	14.0	12.102	12.032	14.018	14.000	12.000	11.957
GSM-1214-15	12.0	+0.032 +0.102	14.0	15.0	12.102	12.032	14.018	14.000	12.000	11.957
GSM-1214-20	12.0	+0.032 +0.102	14.0	20.0	12.102	12.032	14.018	14.000	12.000	11.957
GSM-1214-25	12.0	+0.032 +0.102	14.0	25.0	12.102	12.032	14.018	14.000	12.000	11.957
GSM-1215-06	12.0	+0.032 +0.102	15.0	6.0	12.102	12.032	15.018	15.000	12.000	11.957
GSM-1215-22	12.0	+0.032 +0.102	15.0	22.0	12.102	12.032	15.018	15.000	12.000	11.957
GSM-1315-07	13.0	+0.032 +0.102	15.0	7.0	13.102	13.032	15.018	15.000	13.000	12.957
GSM-1315-075	13.0	+0.032 +0.102	15.0	7.5	13.102	13.032	15.018	15.000	13.000	12.957
GSM-1315-10	13.0	+0.032 +0.102	15.0	10.0	13.102	13.032	15.018	15.000	13.000	12.957
GSM-1315-15	13.0	+0.032 +0.102	15.0	15.0	13.102	13.032	15.018	15.000	13.000	12.957
GSM-1315-20	13.0	+0.032 +0.102	15.0	20.0	13.102	13.032	15.018	15.000	13.000	12.957
GSM-1315-25	13.0	+0.032 +0.102	15.0	25.0	13.102	13.032	15.018	15.000	13.000	12.957
GSM-1416-03	14.0	+0.032 +0.102	16.0	3.0	14.102	14.032	16.018	16.000	14.000	13.957
GSM-1416-06	14.0	+0.032 +0.102	16.0	6.0	14.102	14.032	16.018	16.000	14.000	13.957
GSM-1416-08	14.0	+0.032 +0.102	16.0	8.0	14.102	14.032	16.018	16.000	14.000	13.957
GSM-1416-10	14.0	+0.032 +0.102	16.0	10.0	14.102	14.032	16.018	16.000	14.000	13.957
GSM-1416-12	14.0	+0.032 +0.102	16.0	12.0	14.102	14.032	16.018	16.000	14.000	13.957
GSM-1416-15	14.0	+0.032 +0.102	16.0	15.0	14.102	14.032	16.018	16.000	14.000	13.957
GSM-1416-20	14.0	+0.032 +0.102	16.0	20.0	14.102	14.032	16.018	16.000	14.000	13.957
GSM-1416-25	14.0	+0.032 +0.102	16.0	25.0	14.102	14.032	16.018	16.000	14.000	13.957
GSM-1516-15	15.0	+0.016 +0.059	16.0	15.0	15.059	15.016	16.018	16.000	15.000	14.957
GSM-1517-04	15.0	+0.032 +0.102	17.0	4.0	15.102	15.032	17.018	17.000	15.000	14.957
GSM-1517-10	15.0	+0.032 +0.102	17.0	10.0	15.102	15.032	17.018	17.000	15.000	14.957
GSM-1517-12	15.0	+0.032 +0.102	17.0	12.0	15.102	15.032	17.018	17.000	15.000	14.957
GSM-1517-15	15.0	+0.032 +0.102	17.0	15.0	15.102	15.032	17.018	17.000	15.000	14.957
GSM-1517-20	15.0	+0.032 +0.102	17.0	20.0	15.102	15.032	17.018	17.000	15.000	14.957
GSM-1517-25	15.0	+0.032 +0.102	17.0	25.0	15.102	15.032	17.018	17.000	15.000	14.957
GSM-1618-055	16.0	+0.032 +0.102	18.0	5.5	16.102	16.032	18.018	18.000	16.000	15.957
GSM-1618-08	16.0	+0.032 +0.102	18.0	8.0	16.102	16.032	18.018	18.000	16.000	15.957
GSM-1618-10	16.0	+0.032 +0.102	18.0	10.0	16.102	16.032	18.018	18.000	16.000	15.957
GSM-1618-12	16.0	+0.032 +0.102	18.0	12.0	16.102	16.032	18.018	18.000	16.000	15.957
GSM-1618-13.5	16.0	+0.032 +0.102	18.0	13.5	16.102	16.032	18.018	18.000	16.000	15.957
GSM-1618-13.8	16.0	+0.032 +0.102	18.0	13.8	16.102	16.032	18.018	18.000	16.000	15.957
GSM-1618-15	16.0	+0.032 +0.102	18.0	15.0	16.102	16.032	18.018	18.000	16.000	15.957
GSM-1618-20	16.0	+0.032 +0.102	18.0	20.0	16.102	16.032	18.018	18.000	16.000	15.957
GSM-1618-25	16.0	+0.032 +0.102	18.0	25.0	16.102	16.032	18.018	18.000	16.000	15.957

iglide® G300
Sleeve - MM

PDF: www.igus.com/iglide-pdfs
CAD: www.igus.com/iglide-CAD
RoHS info: www.igus.com/RoHS

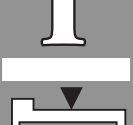
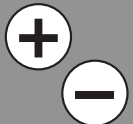

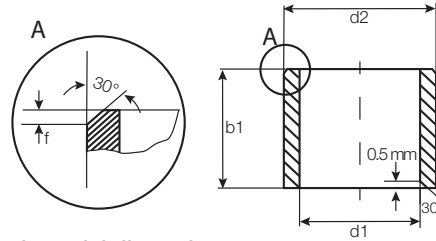

For tolerance values
please refer to page 6.4

Dimensions according to ISO 3547-1 and special dimensions

Part Number	d1	d1-Tolerance after pressfit in \varnothing H7	d2	b1 h13	I.D. After Pressfit		Housing Bore		Shaft Size	
					Max.	Min.	Max.	Min.	Max.	Min.
GSM-1618-30	16.0	+0.032 +0.102	18.0	30.0	16.102	16.032	18.018	18.000	16.000	15.957
GSM-1618-50	16.0	+0.032 +0.102	18.0	50.0	16.102	16.032	18.018	18.000	16.000	15.957
GSM-1819-15	18.0	+0.032 +0.102	19.0	15.0	18.102	18.032	19.021	19.000	18.000	17.957
GSM-1820-10	18.0	+0.032 +0.102	20.0	10.0	18.102	18.032	20.021	20.000	18.000	17.957
GSM-1820-12	18.0	+0.032 +0.102	20.0	12.0	18.102	18.032	20.021	20.000	18.000	17.957
GSM-1820-15	18.0	+0.032 +0.102	20.0	15.0	18.102	18.032	20.021	20.000	18.000	17.957
GSM-1820-20	18.0	+0.032 +0.102	20.0	20.0	18.102	18.032	20.021	20.000	18.000	17.957
GSM-1820-25	18.0	+0.032 +0.102	20.0	25.0	18.102	18.032	20.021	20.000	18.000	17.957
GSM-1820-34	18.0	+0.032 +0.102	20.0	34.0	18.102	18.032	20.021	20.000	18.000	17.957
GSM-1820-45	18.0	+0.032 +0.102	20.0	45.0	18.102	18.032	20.021	20.000	18.000	17.957
GSM-1922-06	19.0	+0.040 +0.124	22.0	6.0	19.124	19.040	22.021	22.000	19.000	18.957
GSM-1922-28	19.0	+0.040 +0.124	22.0	28.0	19.124	19.040	22.021	22.000	19.000	18.957
GSM-1922-35	19.0	+0.040 +0.124	22.0	35.0	19.124	19.040	22.021	22.000	19.000	18.957
GSM-2021-20	20.0	+0.020 +0.072	21.0	20.0	20.072	20.020	21.021	21.000	20.000	19.948
GSM-2022-03	20.0	+0.040 +0.124	22.0	3.0	20.124	20.040	22.021	22.000	20.000	19.948
GSM-2022-08	20.0	+0.040 +0.124	22.0	8.0	20.124	20.040	22.021	22.000	20.000	19.948
GSM-2022-105	20.0	+0.040 +0.124	22.0	10.5	20.124	20.040	22.021	22.000	20.000	19.948
GSM-2022-15	20.0	+0.040 +0.124	22.0	15.0	20.124	20.040	22.021	22.000	20.000	19.948
GSM-2022-20	20.0	+0.040 +0.124	22.0	20.0	20.124	20.040	22.021	22.000	20.000	19.948
GSM-2022-22	20.0	+0.040 +0.124	22.0	22.0	20.124	20.040	22.021	22.000	20.000	19.948
GSM-2022-30	20.0	+0.040 +0.124	22.0	30.0	20.124	20.040	22.021	22.000	20.000	19.948
GSM-2022-47	20.0	+0.040 +0.124	22.0	47.0	20.124	20.040	22.021	22.000	20.000	19.948
GSM-2023-10	20.0	+0.040 +0.124	23.0	10.0	20.124	20.040	23.021	23.000	20.000	19.948
GSM-2023-15	20.0	+0.040 +0.124	23.0	15.0	20.124	20.040	23.021	23.000	20.000	19.948
GSM-2023-20	20.0	+0.040 +0.124	23.0	20.0	20.124	20.040	23.021	23.000	20.000	19.948
GSM-2023-23	20.0	+0.040 +0.124	23.0	23.0	20.124	20.040	23.021	23.000	20.000	19.948
GSM-2023-24	20.0	+0.040 +0.124	23.0	24.0	20.124	20.040	23.021	23.000	20.000	19.948
GSM-2023-25	20.0	+0.040 +0.124	23.0	25.0	20.124	20.040	23.021	23.000	20.000	19.948
GSM-2023-30	20.0	+0.040 +0.124	23.0	30.0	20.124	20.040	23.021	23.000	20.000	19.948
GSM-2224-10	22.0	+0.040 +0.124	24.0	10.0	22.124	22.040	24.021	24.000	22.000	21.948
GSM-2224-15	22.0	+0.040 +0.124	24.0	15.0	22.124	22.040	24.021	24.000	22.000	21.948
GSM-2224-17	22.0	+0.040 +0.124	24.0	17.0	22.124	22.040	24.021	24.000	22.000	21.948
GSM-2224-20	22.0	+0.040 +0.124	24.0	20.0	22.124	22.040	24.021	24.000	22.000	21.948
GSM-2224-30	22.0	+0.040 +0.124	24.0	30.0	22.124	22.040	24.021	24.000	22.000	21.948
GSM-2225-15	22.0	+0.040 +0.124	25.0	15.0	22.124	22.040	25.021	25.000	22.000	21.948
GSM-2225-20	22.0	+0.040 +0.124	25.0	20.0	22.124	22.040	25.021	25.000	22.000	21.948
GSM-2225-25	22.0	+0.040 +0.124	25.0	25.0	22.124	22.040	25.021	25.000	22.000	21.948
GSM-2225-30	22.0	+0.040 +0.124	25.0	30.0	22.124	22.040	25.021	25.000	22.000	21.948
GSM-2427-06	24.0	+0.040 +0.124	27.0	6.0	24.124	24.040	27.021	27.000	24.000	23.948
GSM-2427-15	24.0	+0.040 +0.124	27.0	15.0	24.124	24.040	27.021	27.000	24.000	23.948

iglide® G300
Sleeve - MM

Telephone 1-800-521-2747
Fax 1-401-438-7270

Internet: <http://www.igus.com>
email: sales@igus.com
QuickSpec: <http://www.igus.com/iglide-quickspec>

iglide® Plain Bearings G300 - Sleeve Bearing, MM

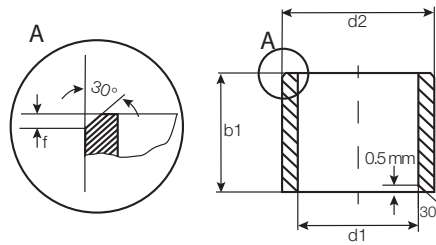

For tolerance values
please refer to page 6.4

Dimensions according to ISO 3547-1 and special dimensions

Part Number	d1	d1-Tolerance after pressfit in Ø H7	d2	b1 h13	I.D. After Pressfit		Housing Bore		Shaft Size	
					Max.	Min.	Max.	Min.	Max.	Min.
GSM-2427-20	24.0	+0.040 +0.124	27.0	20.0	24.124	24.040	27.021	27.000	24.000	23.948
GSM-2427-25	24.0	+0.040 +0.124	27.0	25.0	24.124	24.040	27.021	27.000	24.000	23.948
GSM-2427-30	24.0	+0.040 +0.124	27.0	30.0	24.124	24.040	27.021	27.000	24.000	23.948
GSM-2526-25	25.0	+0.020 +0.072	26.0	25.0	25.072	25.020	26.021	26.000	25.000	24.948
GSM-2528-12	25.0	+0.040 +0.124	28.0	12.0	25.124	25.040	28.021	28.000	25.000	24.948
GSM-2528-15	25.0	+0.040 +0.124	28.0	15.0	25.124	25.040	28.021	28.000	25.000	24.948
GSM-2528-20	25.0	+0.040 +0.124	28.0	20.0	25.124	25.040	28.021	28.000	25.000	24.948
GSM-2528-24	25.0	+0.040 +0.124	28.0	24.0	25.124	25.040	28.021	28.000	25.000	24.948
GSM-2528-25	25.0	+0.040 +0.124	28.0	25.0	25.124	25.040	28.021	28.000	25.000	24.948
GSM-2528-30	25.0	+0.040 +0.124	28.0	30.0	25.124	25.040	28.021	28.000	25.000	24.948
GSM-2528-35	25.0	+0.040 +0.124	28.0	35.0	25.124	25.040	28.021	28.000	25.000	24.948
GSM-2528-50	25.0	+0.040 +0.124	28.0	50.0	25.124	25.040	28.021	28.000	25.000	24.948
GSM-2630-16	26.0	+0.040 +0.124	30.0	16.0	26.124	26.040	30.021	30.000	26.000	25.948
GSM-2730-05	27.0	+0.040 +0.124	30.0	5.0	27.124	26.040	30.025	30.000	27.000	26.948
GSM-2832-10.5	28.0	+0.040 +0.124	32.0	10.5	28.124	28.040	32.025	32.000	28.000	27.948
GSM-2832-12	28.0	+0.040 +0.124	32.0	12.0	28.124	28.040	32.025	32.000	28.000	27.948
GSM-2832-15	28.0	+0.040 +0.124	32.0	15.0	28.124	28.040	32.025	32.000	28.000	27.948
GSM-2832-20	28.0	+0.040 +0.124	32.0	20.0	28.124	28.040	32.025	32.000	28.000	27.948
GSM-2832-23	28.0	+0.040 +0.124	32.0	23.0	28.124	28.040	32.025	32.000	28.000	27.948
GSM-2832-25	28.0	+0.040 +0.124	32.0	25.0	28.124	28.040	32.025	32.000	28.000	27.948
GSM-2832-30	28.0	+0.040 +0.124	32.0	30.0	28.124	28.040	32.025	32.000	28.000	27.948
GSM-3031-12	30.0	+0.020 +0.072	31.0	12.0	30.072	30.020	31.025	31.000	30.000	29.948
GSM-3031-30	30.0	+0.020 +0.072	31.0	30.0	30.072	30.020	31.025	31.000	30.000	29.948
GSM-3034-15	30.0	+0.040 +0.124	34.0	15.0	30.124	30.040	34.025	34.000	30.000	29.948
GSM-3034-20	30.0	+0.040 +0.124	34.0	20.0	30.124	30.040	34.025	34.000	30.000	29.948
GSM-3034-24	30.0	+0.040 +0.124	34.0	24.0	30.124	30.040	34.025	34.000	30.000	29.948
GSM-3034-25	30.0	+0.040 +0.124	34.0	25.0	30.124	30.040	34.025	34.000	30.000	29.948
GSM-3034-30	30.0	+0.040 +0.124	34.0	30.0	30.124	30.040	34.025	34.000	30.000	29.948
GSM-3034-35	30.0	+0.040 +0.124	34.0	35.0	30.124	30.040	34.025	34.000	30.000	29.948
GSM-3034-40	30.0	+0.040 +0.124	34.0	40.0	30.124	30.040	34.025	34.000	30.000	29.948
GSM-3236-20	32.0	+0.050 +0.150	36.0	20.0	32.150	32.050	36.025	36.000	32.000	31.938
GSM-3236-30	32.0	+0.050 +0.150	36.0	30.0	32.150	32.050	36.025	36.000	32.000	31.938
GSM-3236-40	32.0	+0.050 +0.150	36.0	40.0	32.150	32.050	36.025	36.000	32.000	31.938
GSM-3539-14	35.0	+0.050 +0.150	39.0	14.0	35.150	35.050	39.025	39.000	35.000	34.938
GSM-3539-20	35.0	+0.050 +0.150	39.0	20.0	35.150	35.050	39.025	39.000	35.000	34.938
GSM-3539-25	35.0	+0.050 +0.150	39.0	25.0	35.150	35.050	39.025	39.000	35.000	34.938
GSM-3539-30	35.0	+0.050 +0.150	39.0	30.0	35.150	35.050	39.025	39.000	35.000	34.938
GSM-3539-40	35.0	+0.050 +0.150	39.0	40.0	35.150	35.050	39.025	39.000	35.000	34.938
GSM-3539-50	35.0	+0.050 +0.150	39.0	50.0	35.150	35.050	39.025	39.000	35.000	34.938

iglide® G300
Sleeve - MM

PDF: www.igus.com/iglide-pdfs
CAD: www.igus.com/iglide-CAD
RoHS info: www.igus.com/RoHS



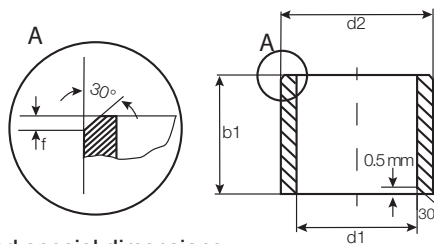

For tolerance values
please refer to page 6.4

Dimensions according to ISO 3547-1 and special dimensions

Part Number	d1	d1-Tolerance after pressfit in Ø H7	d2	b1 h13	I.D. After Pressfit		Housing Bore		Shaft Size	
					Max.	Min.	Max.	Min.	Max.	Min.
GSM-3640-20	36.0	+0.050 +0.150	40.0	20.0	36.150	36.050	40.025	40.000	36.000	35.938
GSM-3741-20	37.0	+0.050 +0.150	41.0	20.0	37.150	37.050	41.025	41.000	37.000	36.938
GSM-4044-10	40.0	+0.050 +0.150	44.0	10.0	40.150	40.050	44.025	44.000	40.000	39.938
GSM-4044-16	40.0	+0.050 +0.150	44.0	16.0	40.150	40.050	44.025	44.000	40.000	39.938
GSM-4044-20	40.0	+0.050 +0.150	44.0	20.0	40.150	40.050	44.025	44.000	40.000	39.938
GSM-4044-30	40.0	+0.050 +0.150	44.0	30.0	40.150	40.050	44.025	44.000	40.000	39.938
GSM-4044-40	40.0	+0.050 +0.150	44.0	40.0	40.150	40.050	44.025	44.000	40.000	39.938
GSM-4044-50	40.0	+0.050 +0.150	44.0	50.0	40.150	40.050	44.025	44.000	40.000	39.938
GSM-4246-40	42.0	+0.050 +0.150	46.0	40.0	42.150	42.050	46.025	46.000	42.000	41.938
GSM-4550-22	45.0	+0.050 +0.150	50.0	22.0	45.150	45.050	50.025	50.000	45.000	44.938
GSM-4550-30	45.0	+0.050 +0.150	50.0	30.0	45.150	45.050	50.025	50.000	45.000	44.938
GSM-4550-38	45.0	+0.050 +0.150	50.0	38.0	45.150	45.050	50.025	50.000	45.000	44.938
GSM-4550-40	45.0	+0.050 +0.150	50.0	40.0	45.150	45.050	50.025	50.000	45.000	44.938
GSM-4550-50	45.0	+0.050 +0.150	50.0	50.0	45.150	45.050	50.025	50.000	45.000	44.938
GSM-5053-50	50.0	+0.050 +0.150	53.0	50.0	50.150	50.050	53.030	53.000	50.000	49.938
GSM-5055-20	50.0	+0.050 +0.150	55.0	20.0	50.150	50.050	55.030	55.000	50.000	49.938
GSM-5055-25	50.0	+0.050 +0.150	55.0	25.0	50.150	50.050	55.030	55.000	50.000	49.938
GSM-5055-30	50.0	+0.050 +0.150	55.0	30.0	50.150	50.050	55.030	55.000	50.000	49.938
GSM-5055-40	50.0	+0.050 +0.150	55.0	40.0	50.150	50.050	55.030	55.000	50.000	49.938
GSM-5055-50	50.0	+0.050 +0.150	55.0	50.0	50.150	50.050	55.030	55.000	50.000	49.938
GSM-5257-20	52.0	+0.060 +0.180	57.0	20.0	52.150	52.050	57.030	57.000	52.000	51.926
GSM-5560-40	55.0	+0.060 +0.180	60.0	40.0	55.180	55.060	60.030	60.000	55.000	54.926
GSM-5560-50	55.0	+0.060 +0.180	60.0	50.0	55.180	55.060	60.030	60.000	55.000	54.926
GSM-5560-60	55.0	+0.060 +0.180	60.0	60.0	55.180	55.060	60.030	60.000	55.000	54.926
GSM-6065-30	60.0	+0.060 +0.180	65.0	30.0	60.180	60.060	65.030	65.000	60.000	59.926
GSM-6065-40	60.0	+0.060 +0.180	65.0	40.0	60.180	60.060	65.030	65.000	60.000	59.926
GSM-6065-50	60.0	+0.060 +0.180	65.0	50.0	60.180	60.060	65.030	65.000	60.000	59.926
GSM-6065-60	60.0	+0.060 +0.180	65.0	60.0	60.180	60.060	65.030	65.000	60.000	59.926
GSM-6267-35	62.0	+0.060 +0.180	67.0	35.0	62.180	62.060	67.030	67.000	62.000	61.926
GSM-6267-72	62.0	+0.060 +0.180	67.0	72.0	62.180	62.060	67.030	67.000	62.000	61.926
GSM-6570-30	65.0	+0.060 +0.180	70.0	30.0	65.180	65.060	70.030	70.000	65.000	64.926
GSM-6570-50	65.0	+0.060 +0.180	70.0	50.0	65.180	65.060	70.030	70.000	65.000	64.926
GSM-7075-60	70.0	+0.060 +0.180	75.0	60.0	70.180	70.060	75.030	75.000	70.000	69.926
GSM-7277-76	72.0	+0.060 +0.180	77.0	76.0	72.180	72.060	77.030	77.000	72.000	71.926
GSM-7277-78	72.0	+0.060 +0.180	77.0	78.0	72.180	72.060	77.030	77.000	72.000	71.926
GSM-7580-40	75.0	+0.060 +0.180	80.0	40.0	75.180	75.060	80.030	80.000	75.000	74.926
GSM-7580-60	75.0	+0.060 +0.180	80.0	60.0	75.180	75.060	80.030	80.000	75.000	74.926
GSM-8085-60	80.0	+0.060 +0.180	85.0	60.0	80.180	80.060	85.030	85.000	80.000	79.926
GSM-8085-100	80.0	+0.060 +0.180	85.0	100.0	80.180	80.060	85.030	85.000	80.000	79.926

iglide® Plain Bearings G300 - Sleeve Bearing, MM



G300

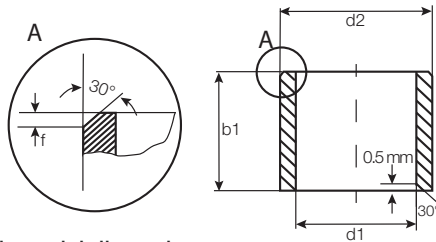

For tolerance values
please refer to page 6.4

Dimensions according to ISO 3547-1 and special dimensions

Part Number	d1	d1-Tolerance after pressfit in Ø H7	d2	b1 h13	I.D. After Pressfit		Housing Bore		Shaft Size	
					Max.	Min.	Max.	Min.	Max.	Min.
GSM-8590-100	85.0	+0.072 +0.212	90.0	100.0	85.212	85.072	90.035	90.000	85.000	84.913
GSM-9095-100	90.0	+0.072 +0.212	95.0	100.0	90.212	90.072	95.035	95.000	90.000	89.913
GSM-95100-100	95.0	+0.072 +0.212	100.0	100.0	95.212	95.072	100.035	100.000	95.000	94.913
GSM-100105-30	100.0	+0.072 +0.212	105.0	30.0	100.212	100.072	105.035	105.000	100.000	99.913
GSM-100105-100	100.0	+0.072 +0.212	105.0	100.0	100.212	100.072	105.035	105.000	100.000	99.913
GSM-110115-100	110.0	+0.072 +0.212	115.0	100.0	110.212	110.072	115.035	115.000	110.000	109.913
GSM-120125-100	120.0	+0.072 +0.212	125.0	100.0	120.212	120.072	125.035	125.000	120.000	119.913
GSM-125130-100	125.0	+0.085 +0.245	130.0	100.0	125.245	125.085	130.040	130.000	125.000	124.800
GSM-130135-100	130.0	+0.085 +0.245	135.0	100.0	130.245	130.085	135.040	135.000	130.000	129.900
GSM-135140-80	135.0	+0.085 +0.245	140.0	80.0	135.245	135.085	140.040	140.000	135.000	134.900
GSM-140145-100	140.0	+0.085 +0.245	145.0	100.0	140.245	140.085	145.040	145.000	140.000	139.900
GSM-150155-100	150.0	+0.085 +0.245	155.0	100.0	150.245	150.085	155.040	155.000	150.000	149.900

iglide® G300
Sleeve - MM

PDF: www.igus.com/iglide-pdfs
CAD: www.igus.com/iglide-CAD
RoHS info: www.igus.com/RoHS

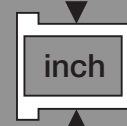
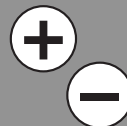

iglide® G300
Flange - MM

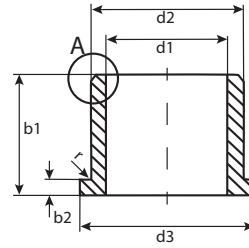
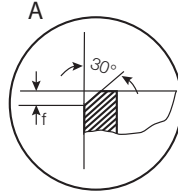

For tolerance values
please refer to page 6.4

r = max. 0.5

Dimensions according to ISO 3547-1 and special dimensions

Part Number	d1 ¹⁾		d2	d3	b1	b2	I.D. After Pressfit		Housing Bore		Shaft Size	
	after Pressfit in Ø H7						Max.	Min.	Max.	Min.	Max.	Min.
GFM-0304-02	3.0	+0.014 +0.054	4.5	7.5	2.0	0.75	3.054	3.014	4.512	4.500	3.000	2.975
GFM-0304-0275	3.0	+0.014 +0.054	4.5	7.5	2.75	0.75	3.054	3.014	4.512	4.500	3.000	2.975
GFM-0304-03	3.0	+0.014 +0.054	4.5	7.5	3.0	0.75	3.054	3.014	4.512	4.500	3.000	2.975
GFM-0304-05	3.0	+0.014 +0.054	4.5	7.5	5.0	0.75	3.054	3.014	4.512	4.500	3.000	2.975
GFM-030407-05	3.0	+0.014 +0.054	4.5	7.0	5.0	0.75	3.054	3.014	4.512	4.500	3.000	2.975
GFM-0405-03	4.0	+0.020 +0.068	5.5	9.5	3.0	0.75	4.068	4.020	5.512	5.500	4.000	3.970
GFM-0405-04	4.0	+0.020 +0.068	5.5	9.5	4.0	0.75	4.068	4.020	5.512	5.500	4.000	3.970
GFM-0405-06	4.0	+0.020 +0.068	5.5	9.5	6.0	0.75	4.068	4.020	5.512	5.500	4.000	3.970
GFM-040508-10	4.0	+0.020 +0.068	5.5	8.0	10.0	0.75	4.068	4.020	5.512	5.500	4.000	3.970
GFM-0506-035	5.0	+0.010 +0.040	6.0	10.0	3.5	0.5	5.040	5.010	6.012	6.000	5.000	4.970
GFM-0506-04	5.0	+0.010 +0.040	6.0	10.0	4.0	0.5	5.040	5.010	6.012	6.000	5.000	4.970
GFM-0506-05	5.0	+0.010 +0.040	6.0	10.0	5.0	0.5	5.040	5.010	6.012	6.000	5.000	4.970
GFM-0506-06	5.0	+0.010 +0.040	6.0	10.0	6.0	0.5	5.040	5.010	6.012	6.000	5.000	4.970
GFM-0506-15	5.0	+0.010 +0.040	6.0	10.0	15.0	0.5	5.040	5.010	6.012	6.000	5.000	4.970
GFM-0507-03	5.0	+0.020 +0.068	7.0	11.0	3.5	1.0	5.068	5.020	7.015	7.000	5.000	4.970
GFM-0507-04	5.0	+0.020 +0.068	7.0	11.0	4.0	1.0	5.068	5.020	7.015	7.000	5.000	4.970
GFM-0507-05	5.0	+0.020 +0.068	7.0	11.0	5.0	1.0	5.068	5.020	7.015	7.000	5.000	4.970
GFM-0507-07	5.0	+0.020 +0.068	7.0	11.0	7.0	1.0	5.068	5.020	7.015	7.000	5.000	4.970
GFM-0507-11	5.0	+0.020 +0.068	7.0	11.0	11.0	1.0	5.068	5.020	7.015	7.000	5.000	4.970
GFM-0507-30	5.0	+0.020 +0.068	7.0	11.0	30.0	1.0	5.068	5.020	7.015	7.000	5.000	4.970
GFM-050715-04	5.0	+0.020 +0.068	7.0	15.0	4.0	1.0	5.068	5.020	7.015	7.000	5.000	4.970
GFM-050709-05	5.0	+0.020 +0.068	7.0	9.0	5.0	1.0	5.068	5.020	7.015	7.000	5.000	4.970
GFM-0607-06	6.0	+0.010 +0.040	7.0	11.0	6.0	0.5	6.040	6.010	7.012	7.000	6.000	5.970
GFM-0607-10	6.0	+0.010 +0.040	7.0	11.0	10.0	0.5	6.040	6.010	7.012	7.000	6.000	5.970
GFM-0607-024	6.0	+0.010 +0.040	7.0	11.0	2.4	0.5	6.040	6.010	7.012	7.000	6.000	5.970
GFM-0608-04	6.0	+0.020 +0.068	8.0	12.0	4.0	1.0	6.068	6.020	8.015	8.000	6.000	5.970
GFM-0608-048	6.0	+0.020 +0.068	8.0	12.0	4.8	1.0	6.068	6.020	8.015	8.000	6.000	5.970
GFM-0608-05	6.0	+0.020 +0.068	8.0	12.0	5.0	1.0	6.068	6.020	8.015	8.000	6.000	5.970
GFM-0608-06	6.0	+0.020 +0.068	8.0	12.0	6.0	1.0	6.068	6.020	8.015	8.000	6.000	5.970
GFM-0608-07	6.0	+0.020 +0.068	8.0	12.0	7.0	1.0	6.068	6.020	8.015	8.000	6.000	5.970
GFM-0608-08	6.0	+0.020 +0.068	8.0	12.0	8.0	1.0	6.068	6.020	8.015	8.000	6.000	5.970
GFM-0608-10	6.0	+0.020 +0.068	8.0	12.0	10.0	1.0	6.068	6.020	8.015	8.000	6.000	5.970
GFM-060810-08	6.0	+0.020 +0.068	8.0	10.0	8.0	1.0	6.068	6.020	8.015	8.000	6.000	5.970
GFM-060812-20	6.0	+0.020 +0.068	8.0	12.0	20.0	1.0	6.068	6.020	8.015	8.000	6.000	5.970
GFM-060814-12	6.0	+0.020 +0.068	8.0	14.0	12.0	1.0	6.068	6.020	8.015	8.000	6.000	5.970
GFM-0708-03	7.0	+0.013 +0.049	8.0	12.0	3.0	0.5	7.049	7.013	8.015	8.000	7.000	6.964
GFM-0708-08	7.0	+0.013 +0.049	8.0	12.0	8.0	0.5	7.049	7.013	8.015	8.000	7.000	6.964
GFM-0709-06	7.0	+0.025 +0.083	9.0	15.0	6.0	1.0	7.068	7.020	9.015	9.000	7.000	6.964
GFM-0709-10	7.0	+0.025 +0.083	9.0	15.0	10.0	1.0	7.068	7.020	9.015	9.000	7.000	6.964
GFM-0709-12	7.0	+0.025 +0.083	9.0	15.0	12.0	1.0	7.068	7.020	9.015	9.000	7.000	6.964

Telephone 1-800-521-2747
Fax 1-401-438-7270

Internet: <http://www.igus.com>
email: sales@igus.com
QuickSpec: <http://www.igus.com/iglide-quickspec>

iglide® Plain Bearings

G300 - Flange Bearing, MM



G300

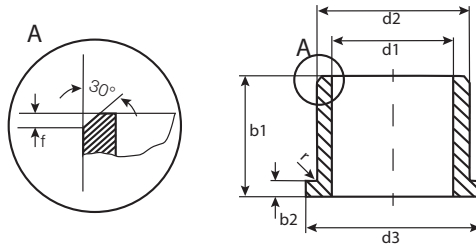

For tolerance values please refer to page 6.4

r = max. 0.5

Dimensions according to ISO 3547-1 and special dimensions

Part Number	d1 ¹⁾ after Pressfit in Ø H7		d2	d3		b1 h13	b2 -0.14	I.D. After Pressfit		Housing Bore		Shaft Size	
	Max.	Min.		Max.	Min.			Max.	Min.	Max.	Min.	Max.	Min.
GFM-070919-10	7.0	+0.025 +0.083	9.0	19.0	10.0	1.0	7.083	7.025	9.015	9.000	7.000	6.964	
GFM-0809-03	8.0	+0.013 +0.049	9.0	15.0	3.0	0.5	8.049	8.013	9.015	9.000	8.000	7.964	
GFM-0809-035	8.0	+0.013 +0.049	9.0	15.0	3.5	0.5	8.049	8.013	9.015	9.000	8.000	7.964	
GFM-0809-055	8.0	+0.013 +0.049	9.0	15.0	5.5	0.5	8.049	8.013	9.015	9.000	8.000	7.964	
GFM-0809-08	8.0	+0.013 +0.049	9.0	15.0	8.0	0.5	8.049	8.013	9.015	9.000	8.000	7.964	
GFM-0809-12	8.0	+0.013 +0.049	9.0	15.0	12.0	0.5	8.049	8.013	9.015	9.000	8.000	7.964	
GFM-0810-02	8.0	+0.025 +0.083	10.0	15.0	2.7	1.0	8.083	8.025	10.015	10.000	8.000	7.964	
GFM-0810-03	8.0	+0.025 +0.083	10.0	15.0	3.0	1.0	8.083	8.025	10.015	10.000	8.000	7.964	
GFM-0810-035	8.0	+0.013 +0.049	10.0	15.0	3.5	1.0	8.083	8.025	10.015	10.000	8.000	7.964	
GFM-0810-04	8.0	+0.025 +0.083	10.0	15.0	4.0	1.0	8.083	8.025	10.015	10.000	8.000	7.964	
GFM-0810-05	8.0	+0.025 +0.083	10.0	15.0	5.5	1.0	8.083	8.025	10.015	10.000	8.000	7.964	
GFM-0810-06	8.0	+0.025 +0.083	10.0	15.0	6.0	1.0	8.083	8.025	10.015	10.000	8.000	7.964	
GFM-0810-065	8.0	+0.025 +0.083	10.0	15.0	6.5	1.0	8.083	8.025	10.015	10.000	8.000	7.964	
GFM-0810-07	8.0	+0.025 +0.083	10.0	15.0	7.5	1.0	8.083	8.025	10.015	10.000	8.000	7.964	
GFM-0810-09	8.0	+0.025 +0.083	10.0	15.0	9.5	1.0	8.083	8.025	10.015	10.000	8.000	7.964	
GFM-0810-10	8.0	+0.025 +0.083	10.0	15.0	10.0	1.0	8.083	8.025	10.015	10.000	8.000	7.964	
GFM-0810-11	8.0	+0.025 +0.083	10.0	15.0	11.0	1.0	8.083	8.025	10.015	10.000	8.000	7.964	
GFM-0810-15	8.0	+0.025 +0.083	10.0	15.0	15.0	1.0	8.083	8.025	10.015	10.000	8.000	7.964	
GFM-0810-25	8.0	+0.025 +0.083	10.0	15.0	25.0	1.0	8.083	8.025	10.015	10.000	8.000	7.964	
GFM-0810-30	8.0	+0.025 +0.083	10.0	15.0	30.0	1.0	8.083	8.025	10.015	10.000	8.000	7.964	
GFM-081013-08	8.0	+0.025 +0.083	10.0	13.0	8.0	1.0	8.083	8.025	10.015	10.000	8.000	7.964	
GFM-081014-05	8.0	+0.025 +0.083	10.0	14.0	5.0	1.0	8.083	8.025	10.015	10.000	8.000	7.964	
GFM-081014-06	8.0	+0.025 +0.083	10.0	14.0	6.0	1.0	8.083	8.025	10.015	10.000	8.000	7.964	
GFM-081014-08	8.0	+0.025 +0.083	10.0	14.0	8.0	1.0	8.083	8.025	10.015	10.000	8.000	7.964	
GFM-081014-10	8.0	+0.025 +0.083	10.0	14.0	10.0	1.0	8.083	8.025	10.015	10.000	8.000	7.964	
GFM-081016-11	8.0	+0.025 +0.083	10.0	16.0	11.0	1.0	8.083	8.025	10.015	10.000	8.000	7.964	
GFM-081016-15	8.0	+0.025 +0.083	10.0	16.0	15.0	1.0	8.083	8.025	10.015	10.000	8.000	7.964	
GFM-081017-15	8.0	+0.025 +0.083	10.0	17.0	15.0	1.0	8.083	8.025	10.015	10.000	8.000	7.964	
GFM-0811-07	8.0	+0.025 +0.083	11.0	15.0	7.0	1.5	8.083	8.025	11.018	11.000	8.000	7.964	
GFM-0910-065	9.0	+0.013 +0.049	10.0	15.0	6.5	0.5	9.049	9.013	10.015	10.000	9.000	8.964	
GFM-0910-17	9.0	+0.013 +0.049	10.0	15.0	17.5	0.5	9.049	9.013	10.015	10.000	9.000	8.964	
GFM-1011-026	10.0	+0.013 +0.049	11.0	15.0	2.6	0.5	10.049	10.013	11.015	11.000	10.000	9.964	
GFM-1011-03	10.0	+0.013 +0.049	11.0	15.0	3.0	0.5	10.049	10.013	11.015	11.000	10.000	9.964	
GFM-1011-044	10.0	+0.013 +0.049	11.0	15.0	4.4	0.5	10.049	10.013	11.015	11.000	10.000	9.964	
GFM-1011-10	10.0	+0.013 +0.049	11.0	15.0	10.0	0.5	10.049	10.013	11.015	11.000	10.000	9.964	
GFM-1012-035	10.0	+0.025 +0.083	12.0	18.0	3.5	1.0	10.083	10.025	12.018	12.000	10.000	9.964	
GFM-1012-04	10.0	+0.025 +0.083	12.0	18.0	4.0	1.0	10.083	10.025	12.018	12.000	10.000	9.964	
GFM-1012-05	10.0	+0.025 +0.083	12.0	18.0	5.0	1.0	10.083	10.025	12.018	12.000	10.000	9.964	
GFM-1012-06	10.0	+0.025 +0.083	12.0	18.0	6.0	1.0	10.083	10.025	12.018	12.000	10.000	9.964	
GFM-101214-06	10.0	+0.025 +0.083	12.0	14.0	6.0	1.0	10.083	10.025	12.018	12.000	10.000	9.964	

iglide® G300
Flange - MM

PDF: www.igus.com/iglide-pdfs
 CAD: www.igus.com/iglide-CAD
 RoHS info: www.igus.com/RoHS

Navigation icons: Home, Search, Info, and unit selection.

Unit selection: mm, inch

iglide® Plain Bearings G300 - Flange Bearing, MM



G300

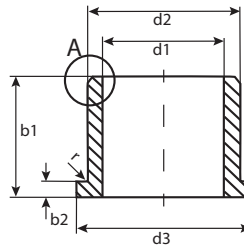
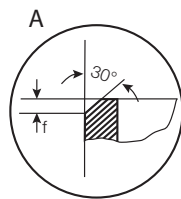

For tolerance values
please refer to page 6.4

r = max. 0.5

Dimensions according to ISO 3547-1 and special dimensions

Part Number	d1 ¹⁾ after Pressfit in Ø H7		d2	d3 d13	b1 h13	b2 -0.14	I.D. After Pressfit		Housing Bore		Shaft Size	
	Max.	Min.					Max.	Min.	Max.	Min.		
GFM-1416-08	14.0	+0.032 +0.102	16.0	22.0	8.0	1.0	14.102	14.032	16.018	16.000	14.000	13.957
GFM-1416-10	14.0	+0.032 +0.102	16.0	22.0	10.0	1.0	14.102	14.032	16.018	16.000	14.000	13.957
GFM-1416-12	14.0	+0.032 +0.102	16.0	22.0	12.0	1.0	14.102	14.032	16.018	16.000	14.000	13.957
GFM-1416-17	14.0	+0.032 +0.102	16.0	22.0	17.0	1.0	14.102	14.032	16.018	16.000	14.000	13.957
GFM-1416-21	14.0	+0.032 +0.102	16.0	22.0	21.0	1.0	14.102	14.032	16.018	16.000	14.000	13.957
GFM-141624-16	14.0	+0.032 +0.102	16.0	24.0	16.0	1.0	14.102	14.032	16.018	16.000	14.000	13.957
GFM-1516-02	15.0	+0.016 +0.059	16.0	20.0	2.0	0.5	15.059	15.016	16.018	16.000	15.000	14.957
GFM-1516-025	15.0	+0.016 +0.059	16.0	20.0	2.5	0.5	15.059	15.016	16.018	16.000	15.000	14.957
GFM-1516-03	15.0	+0.016 +0.059	16.0	20.0	3.0	0.5	15.059	15.016	16.018	16.000	15.000	14.957
GFM-1516-15	15.0	+0.016 +0.059	16.0	20.0	15.0	0.5	15.059	15.016	16.018	16.000	15.000	14.957
GFM-1517-04	15.0	+0.032 +0.102	17.0	23.0	4.0	1.0	15.102	15.032	17.018	17.000	15.000	14.957
GFM-1517-045	15.0	+0.032 +0.102	17.0	23.0	4.5	1.0	15.102	15.032	17.018	17.000	15.000	14.957
GFM-1517-05	15.0	+0.032 +0.102	17.0	23.0	5.0	1.0	15.102	15.032	17.018	17.000	15.000	14.957
GFM-1517-09	15.0	+0.032 +0.102	17.0	23.0	9.0	1.0	15.102	15.032	17.018	17.000	15.000	14.957
GFM-1517-12	15.0	+0.032 +0.102	17.0	23.0	12.0	1.0	15.102	15.032	17.018	17.000	15.000	14.957
GFM-1517-17	15.0	+0.032 +0.102	17.0	23.0	17.0	1.0	15.102	15.032	17.018	17.000	15.000	14.957
GFM-1517-20	15.0	+0.032 +0.102	17.0	23.0	20.0	1.0	15.102	15.032	17.018	17.000	15.000	14.957
GFM-151824-32	15.0	+0.032 +0.102	18.0	24.0	32.0	1.5	15.102	15.032	18.018	18.000	15.000	14.957
GFM-1618-04	16.0	+0.032 +0.102	18.0	24.0	4.0	1.0	16.102	16.032	18.018	18.000	16.000	15.957
GFM-1618-06	16.0	+0.032 +0.102	18.0	24.0	6.0	1.0	16.102	16.032	18.018	18.000	16.000	15.957
GFM-1618-09	16.0	+0.032 +0.102	18.0	24.0	9.0	1.0	16.102	16.032	18.018	18.000	16.000	15.957
GFM-1618-12	16.0	+0.032 +0.102	18.0	24.0	12.0	1.0	16.102	16.032	18.018	18.000	16.000	15.957
GFM-1618-17	16.0	+0.032 +0.102	18.0	24.0	17.0	1.0	16.102	16.032	18.018	18.000	16.000	15.957
GFM-1618-21	16.0	+0.032 +0.102	18.0	24.0	21.0	1.0	16.102	16.032	18.018	18.000	16.000	15.957
GFM-1622-12	16.0	+0.032 +0.102	22.0	25.0	12.0	1.0	16.102	16.032	22.021	22.000	16.000	15.957
GFM-1719-09	17.0	+0.032 +0.102	19.0	25.0	9.0	1.0	17.102	17.032	19.018	19.000	17.000	16.957
GFM-1719-25	17.0	+0.032 +0.102	19.0	25.0	25.0	1.0	17.102	17.032	19.018	19.000	17.000	16.957
GFM-1820-04	18.0	+0.032 +0.102	20.0	26.0	4.0	1.0	18.102	18.032	20.021	20.000	18.000	17.957
GFM-1820-06	18.0	+0.032 +0.102	20.0	26.0	6.0	1.0	18.102	18.032	20.021	20.000	18.000	17.957
GFM-1820-09	18.0	+0.032 +0.102	20.0	26.0	9.0	1.0	18.102	18.032	20.021	20.000	18.000	17.957
GFM-1820-11	18.0	+0.032 +0.102	20.0	26.0	11.0	1.0	18.102	18.032	20.021	20.000	18.000	17.957
GFM-1820-12	18.0	+0.032 +0.102	20.0	26.0	12.0	1.0	18.102	18.032	20.021	20.000	18.000	17.957
GFM-1820-17	18.0	+0.032 +0.102	20.0	26.0	17.0	1.0	18.102	18.032	20.021	20.000	18.000	17.957
GFM-1820-22	18.0	+0.032 +0.102	20.0	26.0	22.0	1.0	18.102	18.032	20.021	20.000	18.000	17.957
GFM-1820-30	18.0	+0.032 +0.102	20.0	26.0	30.0	1.0	18.102	18.032	20.021	20.000	18.000	17.957
GFM-1820-32	18.0	+0.032 +0.102	20.0	26.0	32.0	1.0	18.102	18.032	20.021	20.000	18.000	17.957
GFM-182022-06	18.0	+0.032 +0.102	20.0	22.0	6.0	1.0	18.102	18.032	22.021	22.000	18.000	17.957
GFM-1822-28	18.0	+0.032 +0.102	20.0	26.0	28.0	2.0	18.102	18.032	22.021	22.000	18.000	17.957
GFM-2021-035	20.0	+0.020 +0.072	21.0	25.0	3.5	0.5	20.072	20.020	21.021	21.000	20.000	19.948
GFM-2021-20	20.0	+0.020 +0.072	21.0	25.0	20.0	0.5	20.072	20.020	21.021	21.000	20.000	19.948
GFM-2023-07	20.0	+0.040 +0.124	23.0	30.0	7.0	1.5	20.124	20.040	23.021	23.000	20.000	19.948

iglide® G300
Flange - MM

PDF: www.igus.com/iglide-pdfs
CAD: www.igus.com/iglide-CAD
RoHS info: www.igus.com/RoHS



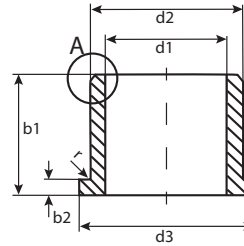
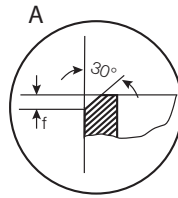

For tolerance values
please refer to page 6.4

$r = \max. 0.5$

Dimensions according to ISO 3547-1 and special dimensions

Part Number	d1 ¹⁾ after Pressfit in Ø H7	d1-Tolerance	d2	d3 d13	b1 h13	b2 -0.14	I.D. After Pressfit		Housing Bore		Shaft Size	
							Max.	Min.	Max.	Min.	Max.	Min.
GFM-2023-11	20.0	+0.040 +0.124	23.0	30.0	11.5	1.5	20.124	20.040	23.021	23.000	20.000	19.948
GFM-2023-16	20.0	+0.040 +0.124	23.0	30.0	16.5	1.5	20.124	20.040	23.021	23.000	20.000	19.948
GFM-2023-21	20.0	+0.040 +0.124	23.0	30.0	21.5	1.5	20.124	20.040	23.021	23.000	20.000	19.948
GFM-202329-20	20.0	+0.040 +0.124	23.0	30.0	20.0	1.5	20.124	20.040	23.021	23.000	20.000	19.948
GFM-202326-21	20.0	+0.040 +0.124	23.0	26.0	21.0	1.5	20.124	20.040	23.021	23.000	20.000	19.948
GFM-202328-15	20.0	+0.040 +0.124	23.0	28.0	15.0	1.5	20.124	20.040	23.021	23.000	20.000	19.948
GFM-2427-07	24.0	+0.040 +0.124	27.0	32.0	7.0	1.5	24.124	24.040	27.021	27.000	24.000	23.948
GFM-2427-10	24.0	+0.040 +0.124	27.0	32.0	10.0	1.5	24.124	24.040	27.021	27.000	24.000	23.948
GFM-2526-25	25.0	+0.020 +0.072	26.0	30.0	25.0	0.5	25.072	25.020	26.021	26.000	25.000	24.948
GFM-2527-48	25.0	+0.040 +0.124	27.0	32.0	48.0	1.0	25.124	25.040	27.021	27.000	25.000	24.948
GFM-2528-11	25.0	+0.040 +0.124	28.0	35.0	11.5	1.5	25.124	25.040	28.021	28.000	25.000	24.948
GFM-2528-16	25.0	+0.040 +0.124	28.0	35.0	16.5	1.5	25.124	25.040	28.021	28.000	25.000	24.948
GFM-2528-21	25.0	+0.040 +0.124	28.0	35.0	21.5	1.5	25.124	25.040	28.021	28.000	25.000	24.948
GFM-2630-12	26.0	+0.040 +0.124	30.0	35.0	12.0	2.0	26.124	26.040	30.021	30.000	26.000	25.948
GFM-2730-20	27.0	+0.040 +0.124	30.0	35.0	20.0	1.5	27.124	27.040	30.021	30.000	27.000	26.948
GFM-2830-10	28.0	+0.040 +0.124	30.0	35.0	10.0	1.0	28.124	28.040	30.025	30.000	28.000	27.948
GFM-2830-36	28.0	+0.040 +0.124	30.0	35.0	36.0	1.0	28.124	28.040	30.025	30.000	28.000	27.948
GFM-283239-20	28.0	+0.040 +0.124	32.0	39.0	20.0	2.0	28.124	28.040	32.025	32.000	28.000	27.948
GFM-3031-20	30.0	+0.040 +0.124	31.0	36.0	20.0	0.5	30.124	30.040	31.025	31.000	30.000	29.948
GFM-3031-30	30.0	+0.040 +0.124	31.0	35.0	30.0	0.5	30.124	30.040	31.025	31.000	30.000	29.948
GFM-3032-04	30.0	+0.040 +0.124	32.0	37.0	4.0	1.0	30.124	30.040	32.025	32.000	30.000	29.948
GFM-3032-12	30.0	+0.040 +0.124	32.0	37.0	12.0	1.0	30.124	30.040	32.025	32.000	30.000	29.948
GFM-3032-17	30.0	+0.040 +0.124	32.0	37.0	17.5	1.0	30.124	30.040	32.025	32.000	30.000	29.948
GFM-3032-22	30.0	+0.040 +0.124	32.0	37.0	22.0	1.0	30.124	30.040	32.025	32.000	30.000	29.948
GFM-3034-09	30.0	+0.040 +0.124	34.0	42.0	9.0	2.0	30.124	30.040	34.025	34.000	30.000	29.948
GFM-3034-16	30.0	+0.040 +0.124	34.0	42.0	16.0	2.0	30.124	30.040	34.025	34.000	30.000	29.948
GFM-3034-20	30.0	+0.040 +0.124	34.0	42.0	20.0	2.0	30.124	30.040	34.025	34.000	30.000	29.948
GFM-3034-26	30.0	+0.040 +0.124	34.0	42.0	26.0	2.0	30.124	30.040	34.025	34.000	30.000	29.940
GFM-3034-37	30.0	+0.040 +0.124	34.0	42.0	37.0	2.0	30.124	30.040	34.025	34.000	30.000	29.948
GFM-303440-10	30.0	+0.040 +0.124	34.0	40.0	10.0	2.0	30.124	30.040	34.025	34.000	30.000	29.948
GFM-3236-16	32.0	+0.050 +0.150	36.0	40.0	16.0	2.0	32.150	32.050	36.025	36.000	32.000	31.938
GFM-3236-26	32.0	+0.050 +0.150	36.0	40.0	26.0	2.0	32.150	32.050	36.025	36.000	32.000	31.938
GFM-343850-35	34.0	+0.050 +0.150	38.0	50.0	35.0	2.0	34.150	34.050	38.025	38.000	34.000	34.938
GFM-3539-058	35.0	+0.050 +0.150	39.0	47.0	5.8	2.0	35.150	35.050	39.025	39.000	35.000	34.938
GFM-3539-07	35.0	+0.050 +0.150	39.0	47.0	7.0	2.0	35.150	35.050	39.025	39.000	35.000	34.938
GFM-3539-16	35.0	+0.050 +0.150	39.0	47.0	16.0	2.0	35.150	35.050	39.025	39.000	35.000	34.938
GFM-3539-26	35.0	+0.050 +0.150	39.0	47.0	26.0	2.0	35.150	35.050	39.025	39.000	35.000	34.938
GFM-3539-36	35.0	+0.050 +0.150	39.0	47.0	36.0	2.0	35.150	35.050	39.025	39.000	35.000	34.938
GFM-354051-30	35.0	+0.050 +0.150	40.0	51.0	30.0	2.5	35.150	35.050	40.025	40.000	35.000	34.938
GFM-3842-22	38.0	+0.050 +0.150	42.0	54.0	22.0	2.0	38.150	38.050	42.025	42.000	38.000	37.938
GFM-4044-07	40.0	+0.050 +0.150	44.0	52.0	7.0	2.0	40.150	40.050	44.025	44.000	40.000	39.938
GFM-4044-14	40.0	+0.050 +0.150	44.0	52.0	14.0	2.0	40.150	40.050	44.025	44.000	40.000	39.938

iglide® Plain Bearings G300 - Flange Bearing, MM

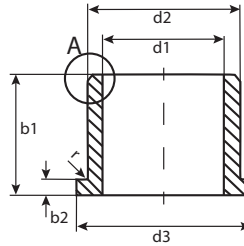
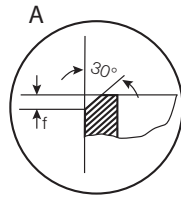

For tolerance values
please refer to page 6.4

r = max. 0.5

Dimensions according to ISO 3547-1 and special dimensions

Part Number	d1 ¹⁾ after Pressfit in Ø H7	d1-Tolerance	d2	d3 d13	b1 h13	b2 -0.14	I.D. After Pressfit		Housing Bore		Shaft Size	
							Max.	Min.	Max.	Min.	Max.	Min.
GFM-4044-20	40.0	+0.050 +0.150	44.0	52.0	20.0	2.0	40.150	40.050	44.025	44.000	40.000	39.938
GFM-4044-30	40.0	+0.050 +0.150	44.0	52.0	30.0	2.0	40.150	40.050	44.025	44.000	40.000	39.938
GFM-4044-40	40.0	+0.050 +0.150	44.0	52.0	40.0	2.0	40.150	40.050	44.025	44.000	40.000	39.938
GFM-4044-50	40.0	+0.050 +0.150	44.0	52.0	50.0	2.0	40.150	40.050	44.025	44.000	40.000	39.938
GFM-4246-19	42.0	+0.050 +0.150	46.0	53.0	19.0	2.0	42.150	42.050	46.025	46.000	42.000	41.938
GFM-4550-30	45.0	+0.050 +0.150	50.0	58.0	30.0	2.0	45.150	45.050	50.025	50.000	45.000	44.938
GFM-4550-50	45.0	+0.050 +0.150	50.0	58.0	50.0	2.0	45.150	45.050	50.025	50.000	45.000	44.938
GFM-5055-07	50.0	+0.050 +0.150	55.0	63.0	7.0	2.0	50.150	50.050	55.030	55.000	50.000	49.938
GFM-5055-10	50.0	+0.050 +0.150	55.0	63.0	10.0	2.0	50.150	50.050	55.030	55.000	50.000	49.938
GFM-5055-18	50.0	+0.050 +0.150	55.0	63.0	18.0	2.0	50.150	50.050	55.030	55.000	50.000	49.938
GFM-5055-25	50.0	+0.050 +0.150	55.0	63.0	25.0	2.0	50.150	50.050	55.030	55.000	50.000	49.938
GFM-5055-40	50.0	+0.050 +0.150	55.0	63.0	40.0	2.0	50.150	50.050	55.030	55.000	50.000	49.938
GFM-5055-50	50.0	+0.050 +0.150	55.0	63.0	50.0	2.0	50.150	50.050	55.030	55.000	50.000	49.938
GFM-6065-07	60.0	+0.060 +0.180	65.0	73.0	7.0	2.0	60.180	60.060	65.030	65.000	60.000	59.926
GFM-6065-22	60.0	+0.060 +0.180	65.0	73.0	22.0	2.0	60.180	60.060	65.030	65.000	60.000	59.926
GFM-6065-30	60.0	+0.060 +0.180	65.0	73.0	30.0	2.0	60.180	60.060	65.030	65.000	60.000	59.926
GFM-6065-50	60.0	+0.060 +0.180	65.0	73.0	50.0	2.0	60.180	60.060	65.030	65.000	60.000	59.926
GFM-606580-62	60.0	+0.060 +0.180	65.0	80.0	62.0	2.0	60.180	60.060	65.030	65.000	60.000	59.926
GFM-6570-50	65.0	+0.060 +0.180	70.0	78.0	50.0	2.0	65.180	65.060	70.030	70.000	65.000	64.926
GFM-7075-50	70.0	+0.060 +0.180	75.0	83.0	50.0	2.0	70.180	70.060	75.030	75.000	70.000	69.926
GFM-7580-50	75.0	+0.060 +0.180	80.0	88.0	50.0	2.0	75.180	75.060	80.030	80.000	75.000	74.926
GFM-8085-100	80.0	+0.060 +0.180	85.0	93.0	100.0	2.5	80.180	80.040	85.030	85.000	80.000	79.926
GFM-8590-100	85.0	+0.072 +0.212	90.0	98.0	100.0	2.5	85.212	85.072	90.035	90.000	85.000	84.913
GFM-9095-100	90.0	+0.072 +0.212	95.0	103.0	100.0	2.5	90.212	90.072	95.035	95.000	90.000	89.913
GFM-95100-100	95.0	+0.072 +0.212	100.0	108.0	100.0	2.5	95.212	95.072	100.035	100.000	95.000	94.913
GFM-100105-42.5	100.0	+0.072 +0.212	105.0	113.0	42.5	2.5	100.212	100.072	105.035	105.000	100.000	99.913
GFM-100105-100	100.0	+0.072 +0.212	105.0	113.0	100.0	2.5	100.212	100.072	105.035	105.000	100.000	99.913
GFM-110115-100	110.0	+0.072 +0.212	115.0	123.0	100.0	2.5	110.212	110.072	115.035	115.000	110.000	109.913
GFM-120125-100	120.0	+0.072 +0.212	125.0	133.0	100.0	2.5	120.212	120.072	125.035	125.000	120.000	119.913
GFM-125130-100	125.0	+0.085 +0.245	130.0	138.0	100.0	2.5	125.245	125.085	130.040	130.000	125.000	124.900
GFM-130135-100	130.0	+0.085 +0.245	135.0	143.0	100.0	2.5	130.245	130.085	135.040	135.000	130.000	129.900
GFM-140145-100	140.0	+0.085 +0.245	145.0	153.0	100.0	2.5	140.245	140.085	145.040	145.000	140.000	139.900
GFM-150155-40	150.0	+0.085 +0.245	155.0	163.0	40.0	2.5	150.245	150.085	155.040	155.000	150.000	149.900
GFM-150155-100	150.0	+0.085 +0.245	155.0	163.0	100.0	2.5	150.245	150.085	155.040	155.000	150.000	149.900

iglide® G300
Flange - MM

PDF: www.igus.com/iglide-pdfs
CAD: www.igus.com/iglide-CAD
RoHS info: www.igus.com/RoHS

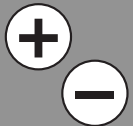

iglide® G300

Thrust Washer - MM

Telephone 1-800-521-2747

Fax 1-401-438-7270

Internet: <http://www.igus.com>email: sales@igus.comQuickSpec: <http://www.igus.com/iglide-quickspec>

6.26

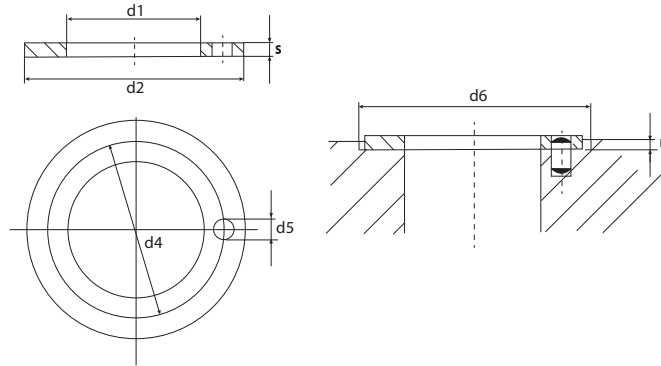

Part Number	d1 +0.25	d2 -0.25	s -0.05	d4 -0.12 +0.12	d5 +0.375 +0.125	h +0.2 -0.2	d6 +0.12
GTM-0509-006	5.0	9.5	0.6	*	*	0.3	9.5
GTM-0615-015	6.0	15.0	1.5	*	*	1.0	15
GTM-0620-015	6.0	20.0	1.5	13.0	1.5	1.0	20
GTM-0713-005	7.0	13.0	0.5	*	*	0.2	13
GTM-0815-005	8.0	15.0	0.5	*	*	0.2	15
GTM-0815-015	8.0	15.0	1.5	11.5	*	1.0	15
GTM-0818-010	8.0	18.0	1.0	*	*	0.7	18
GTM-0818-015	8.0	18.0	1.5	13.0	1.5	1.0	18
GTM-0918-015	9.0	18.0	1.5	13.5	1.5	1.0	18
GTM-1018-010	10.0	18.0	1.0	*	*	0.7	18
GTM-1018-020	10.0	18.0	2.0	*	*	1.5	18
GTM-1224-015	12.0	24.0	1.5	18.0	1.5	1.0	24
GTM-1420-015	14.0	20.0	1.5	*	*	1.0	20
GTM-1426-015	14.0	26.0	1.5	20.0	2.0	1.0	26
GTM-1522-008	15.0	22.0	0.8	*	*	0.5	22
GTM-1524-015	15.0	24.0	1.5	19.5	1.5	1.0	24
GTM-1524-0275	15.0	24.0	2.75	*	*	2.0	24
GTM-1630-015	16.0	30.0	1.5	22.0	2.0	1.0	30
GTM-1832-015	18.0	32.0	1.5	25.0	2.0	1.0	32
GTM-2036-015	20.0	36.0	1.5	28.0	3.0	1.0	36
GTM-2238-015	22.0	38.0	1.5	30.0	3.0	1.0	38
GTM-2442-015	24.0	42.0	1.5	33.0	3.0	1.0	42
GTM-2644-015	26.0	44.0	1.5	35.0	3.0	1.0	44
GTM-2835-005	28.0	35.0	0.5	*	*	0.2	35
GTM-2848-015	28.0	48.0	1.5	38.0	4.0	1.0	48
GTM-3254-015	32.0	54.0	1.5	43.0	4.0	1.0	54
GTM-3862-015	38.0	62.0	1.5	50.0	4.0	1.0	62
GTM-4266-015	42.0	66.0	1.5	54.0	4.0	1.0	66
GTM-4874-020	48.0	74.0	2.0	61.0	4.0	1.5	74
GTM-5278-020	52.0	78.0	2.0	65.0	4.0	1.5	78
GTM-6290-020	62.0	90.0	2.0	76.0	4.0	1.5	90
GTM-6881-020	68.0	81.0	2.0	*	*	1.5	81

* Designed without fixing bore

igus[®]



iglide[®] L280

Product Range

- Standard Styles:
Sleeve, Flange and Thrust Washer
- Custom shapes and sizes available
- Inner diameters:
Inch sizes from 1/8 - 2-1/4 in.
Metric sizes from 2 - 120 mm

Part Number Structure

Part Number Structure

L S I-02 03-03

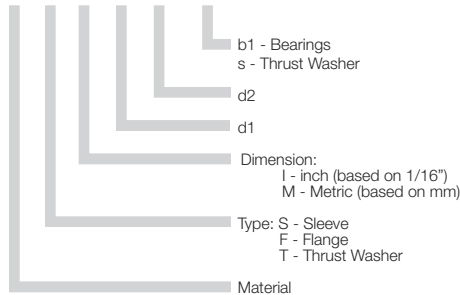

Permissible Surface Speeds

	Continuous fpm	Short Term fpm
Rotating	196	492
Oscillating	137	354
Linear	787	1181

Usage Guidelines



- When especially high service life is necessary
- When low coefficients of dynamic friction and high wear resistance are needed
- For use on 303 stainless steel shafts
- For harsh environments and very rough shaft



- For high loads starting at 7250 psi
➤ iglide® Q
- When temperatures are continuously above 266°F
➤ iglide® T500, F, Z
- When an especially economical bearing is desired
➤ iglide® G300



Visit www.igus.com
to use our online
expert system

Material Data

General Properties	Unit	iglide® L280	Testing Method
Density	g/cm ³	1.24	
Color		yellow	
Max. moisture absorption at 73°F / 50% r.h.	% weight	1.3	DIN 53495
Max. moisture absorption	% weight	6.5	
Coefficient of friction, dynamic against steel	μ	0.08 - 0.23	
p x v-value, max. (dry)	psi x fpm	6,600	

Mechanical Properties

Modulus of elasticity	psi	507,500	DIN 53457
Tensile strength at 68°F	psi	18,125	DIN 53452
Compressive strength	psi	8,845	
Permissible static surface pressure (68°F)	psi	8,700	
Shore D-hardness		77	DIN 53505

Physical and Thermal Properties

Max. long-term application temperature	°F	194	
Max. short-term application temperature	°F	356	
Min. application temperature	°F	-40	
Thermal conductivity	W/m x K	0.24	ASTM C 177
Coefficient of thermal expansion (at 73°F)	K ⁻¹ x 10 ⁻⁵	9	DIN 53752

Electrical Properties

Specific volume resistance	Ωcm	> 10 ¹³	DIN IEC 93
Surface resistance	Ω	> 10 ¹²	DIN 53482

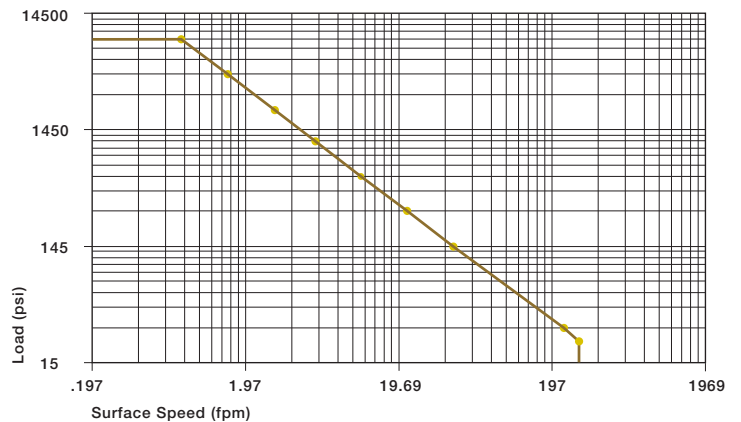

High wear resistance, even in harsh environments or in connection with rough shafts, characterizes the iglide® L280 material. Of all iglide® materials, this material is the most resistant to these types of external effects.

Compressive Strength

iglide® L280 exhibits a very high compression resistance in spite of its high elasticity. Graph 7.2 shows the elastic deformation of iglide® L280 under radial loading. At the maximum permissible load of 8700 psi, the deformation at room temperature is less than 3%. Below the maximum permissible pressure load of 8700 psi, the deformation at room temperature is virtually zero.

➤ Compressive Strength, Page 1.3

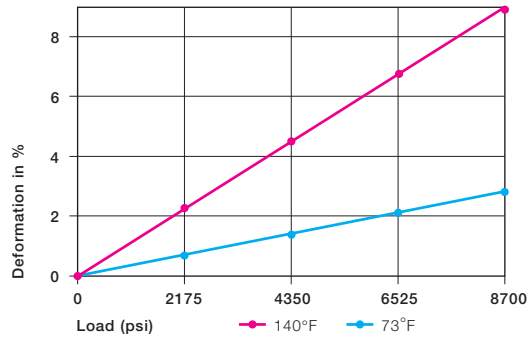

Graph 7.2: Deformation under load and temperature

Permissible Surface Speeds

Even at higher surface speeds, the coefficients of friction for iglide® L280 do not increase. Therefore, compared to other materials, higher surface speeds can be obtained, for example, up to 295 fpm rotating and up to 984 fpm linear.

The bearing wear remains low when used for long periods at high speeds, due to exceptional wear resistance.

Especially high speeds can be obtained with iglide® L280 bearings on hardened shafts with recommended surface finish.

- Surface Speed, Page 1.5
- p x v Value, Page 1.6

	Continuous fpm	Short Term fpm
Rotating	196	492
Oscillating	137	354
Linear	787	1181

Table 7.2: Maximum surface speeds

Temperatures

iglide® L280 plain bearings show minimal reaction to changing external effects. This also applies to temperatures. iglide® L280 bearings maintain their exceptional wear resistance even up to the highest permissible application temperatures and at the same time resist becoming brittle at low temperatures.

On the other hand, the mechanical properties at high temperatures limit the application of iglide® L280. Even at temperatures of 176°F, relaxation of the bearing can occur. In this process, the pressfit forces of the bearing decrease to a large extent due to temperature. During re-cooling and the resulting contraction caused by it, migration of the bearing can occur.

In order to avoid this situation, iglide® L280 plain bearings always need to be axially secured in applications at 176°F and above.

➤ Application Temperatures, Page 1.7

iglide® L280	Application Temperature
Minimum	-40 °F
Max. long-term	+194 °F
Mechanical (ges.)	+266 °F
Max. short-term	+356 °F

Table 7.3: Temperature limits for iglide® L280

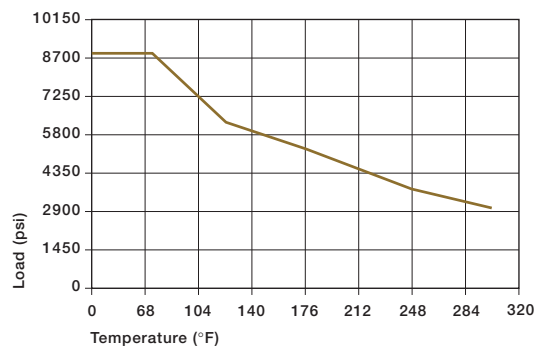

Graph 7.3: Recommended maximum permissible static surface pressure of iglide® L280 as a result of temperature

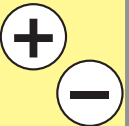

iglide® L280

Telephone 1-800-521-2747
1-401-438-7270
Fax

Internet: <http://www.igus.com>
email: sales@igus.com
QuickSpec: <http://www.igus.com/iglide-quickspec>

Installation Tolerances

iglide® L280 plain bearings are oversized before being pressfit. After proper installation into a recommended housing bore, the inner diameter adjusts to meet our specified tolerances. Please adhere to the catalog specifications for housing bore and recommended shaft sizes. This will help to ensure optimal performance of iglide® plain bearings.

- See Tolerance Table, Page 1.14
- Testing Methods, Page 1.15

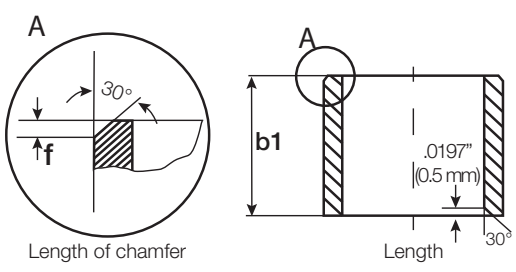

For Inch Size Bearings		
Length Tolerance (b1)	Length of Chamfer (f)	
Length (inches)	Tolerance (h13) (inches)	Based on d1
0.1181 to 0.2362	-0.0000 /-0.0071	f = .012 → d ₁ .040" - .236"
0.2362 to 0.3937	-0.0000 /-0.0087	f = .019 → d ₁ > .236" - .472"
0.3937 to 0.7086	-0.0000 /-0.0106	f = .031 → d ₁ > .472" - 1.18"
0.7086 to 1.1811	-0.0000 /-0.0130	f = .047 → d ₁ > 1.18"
1.1811 to 1.9685	-0.0000 /-0.0154	
1.9685 to 3.1496	-0.0000 /-0.0181	

For Metric Size Bearings		
Length Tolerance (b1)	Length of Chamfer (f)	
Length (mm)	Tolerance (h13) (µm)	Based on d1
1 to 3	-0 /-140	f = 0.3 → d ₁ 1 - 6 mm
> 3 to 6	-0 /-180	f = 0.5 → d ₁ > 6 - 12 mm
> 6 to 10	-0 /-220	f = 0.8 → d ₁ > 12 - 30 mm
> 10 to 18	-0 /-270	f = 1.2 → d ₁ > 30 mm
> 18 to 30	-0 /-330	
> 30 to 50	-0 /-390	
> 50 to 80	-0 /-460	

Friction and Wear

The coefficients of friction for iglide® L280 decrease with increasing load. In the dry run against steel (Cold Rolled Steel), friction is reduced when load ranges from p = 72.5 to 507.5 psi by approximately 25%.

In contrast to other iglide® materials, the coefficient of friction of iglide® L280 remains consistently low at higher rotational speeds. Friction and wear are also, dependent, to a large degree on the shafting partner. Shafts that are too smooth increase both the coefficient of friction and the wear of the bearing. Smooth shafts have the danger of stick-slip. Squeaking as an effect of stick-slip is mostly the result of shafts that are too smooth. For iglide L280 a ground surface with an average roughness range of 16-20 rms is recommended for the shaft. Tests with iglide® L280 have shown the wear resistance at this roughness is very high, while the friction assumes its lowest value.

- Coefficients of Friction and Surfaces, Page 1.8
- Wear Resistance, Page 1.9

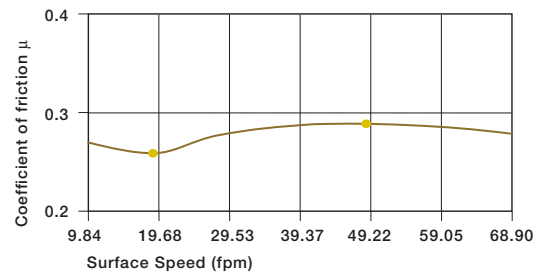

Graph 7.4: Coefficient of friction of iglide® L280 as a result of the surface speed, p = 108 psi, shaft made of Cold Rolled Steel

iglide® L280	Coefficient of Friction
Dry	0.08 - 0.23
Grease	0.09
Oil	0.04
Water	0.04

Table 7.4: Coefficient of friction for iglide® L280 against steel (Shaft Finish = 40 rms, 50 HRC)

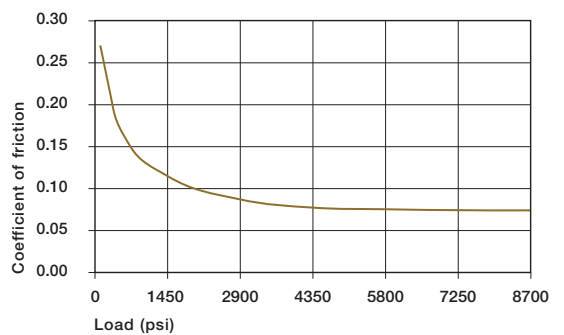

Graph 7.5: Coefficient of friction of iglide® L280 as a result of the load, v = 1.97 fpm

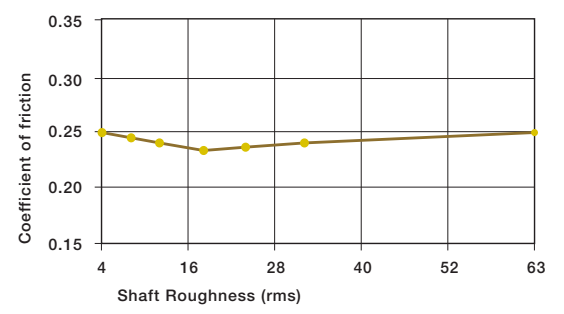

Graph 7.6: Coefficients of friction for iglide® L280 as a result of the shaft surface (shaft Cold Rolled Steel)

Shaft Materials

Graph 7.7 and 7.8 show results of testing different shaft materials with plain bearings made of iglide® L280.

For rotational applications with low loads, the wear varies according to the shaft material. iglide® L280 provides very good to acceptable coefficients of friction for all shafts that were tested. iglide® L280 likes hard shafts. For small radial loads with hard-chromed shafts and/or shafts made of corrosion-resistant steel, iglide® L280 is the best suited iglide® material.

The soft shaft materials HR carbon steel and free-cutting steel are not as well suited for plain bearings made of iglide® L280.

Hardened shafts are preferred for applications for higher loads. Graph 7.8 clearly shows the difference in materials for increasing loads. A similar picture emerges for oscillating applications. First, for low loads, the wear for the oscillating movement lies below that of a rotation at the same load. For higher loads, the situation changes. If the shaft material you plan to use is not contained in this listing, please contact us.

► Shaft Materials, Page 1.11

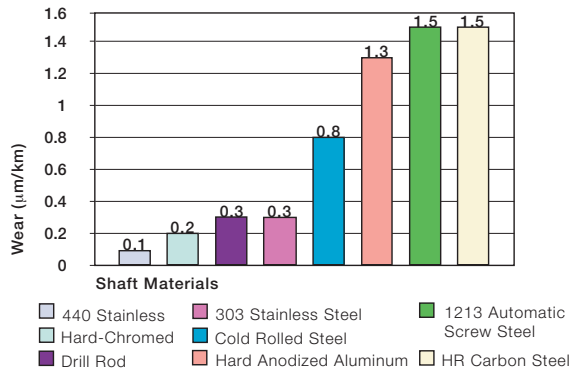

Graph 7.7: Wear of iglide® L280 with different shaft materials (p = 108 psi)

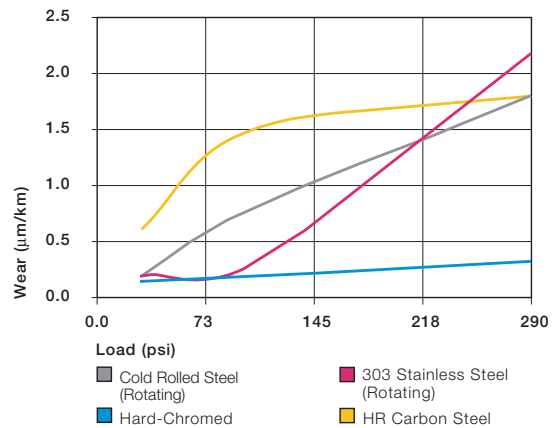

Graph 7.8: Wear with different shaft materials in rotational operation, as a result of the load

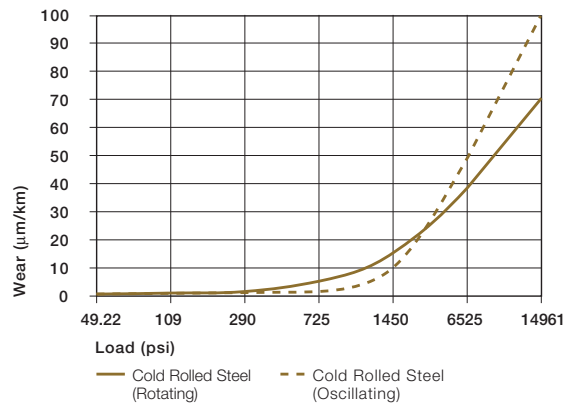

Graph 7.9: Wear for oscillating and rotating applications with shaft material Cold Rolled Steel, as a result of the load

Chemical Resistance

iglide® L280 plain bearings have a good resistance to chemicals. They are resistant to most lubricants. iglide® L280 is not attacked by most weak organic and inorganic acids.

The moisture absorption of iglide® L280 plain bearings is approximately 1.3% weight in the standard atmosphere. The maximum water absorption is 6.5%. This must be taken into account along with other environmental influences.

► Chemical Table, Page 1.16

Medium	Resistance
Alcohol	+ to 0
Hydrocarbons, chlorinated	+
Greases, oils without additives	+
Fuels	+
Weak acids	0 to -
Strong acids	-
Weak alkaline	+
Strong alkaline	0

+ resistant, 0 conditionally resistant, - not resistant

Table 7.5: Chemical resistance of iglide® L280
All data given concerns the chemical resistance at room temperature (68°F). For a complete list, see page 1.16

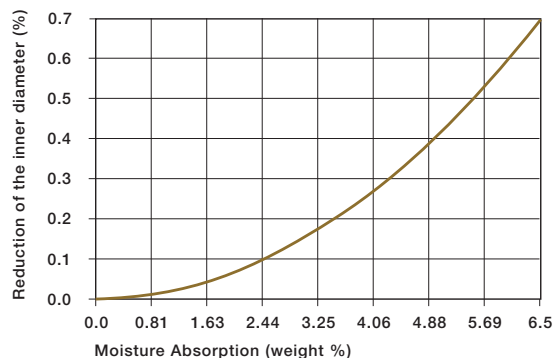

Graph 7.10: Effect of moisture absorption on iglide® L280 plain bearings

iglide® L280

PDF: www.igus.com/iglide-pdfs
CAD: www.igus.com/iglide-CAD
RoHS info: www.igus.com/RoHS



Radiation Resistance

Plain bearings made from iglide® L280 are resistant to radiation up to an intensity of 3×10^2 Gy.

UV-Resistance

iglide® L280 plain bearings are permanently resistant to UV radiation. A slight change in color (dark coloration) due to UV radiation and other weathering effects will not significantly influence the mechanical, electrical or thermal properties.

Vacuum

In a vacuum, iglide® L280 plain bearings will outgas any moisture they may have absorbed. The use of iglide® L280 in a vacuum environment is only possible to a limited extent.

Electrical Properties

iglide® L280 plain bearings are electrically insulating.

iglide® L280

Specific volume resistance	> 10^{13} Ωcm
Surface Resistance	> 10^{12} Ω

Table 7.6: Electrical properties of iglide® L280

Application Examples



Picture 7.1: By converting to iglide® L280, the life of the bearing on this tea bag packaging machine was increased five times



Picture 7.3: iglide® L280, the highest wear resistance even in those places where abrasive media contact the bearing



Picture 7.2: Low coefficients of friction allow for small driving forces



Picture 7.4: A quote from the test evaluation: "The plain bearing with the L280 material showed no wear at all".

iglide® Plain Bearings L280 - Sleeve, Inch

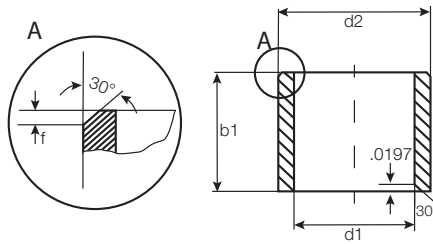

For tolerance values
please refer to page 7.4

iglide® L280
Sleeve - Inch

Part Number	d1	d2	b1	I.D. After Pressfit		Housing Bore		Shaft Size	
				Max.	Min.	Max.	Min.	Max.	Min.
LSI-0203-03	1/8	3/16	3/16	.1269	.1251	.1878	.1873	.1243	.1236
LSI-0203-04	1/8	3/16	1/4	.1269	.1251	.1878	.1873	.1243	.1236
LSI-0203-06	1/8	3/16	3/8	.1269	.1251	.1878	.1873	.1243	.1236
LSI-0304-04	3/16	1/4	1/4	.1892	.1873	.2503	.2497	.1865	.1858
LSI-0304-06	3/16	1/4	3/8	.1892	.1873	.2503	.2497	.1865	.1858
LSI-0304-08	3/16	1/4	1/2	.1892	.1873	.2503	.2497	.1865	.1858
LSI-0405-03	1/4	5/16	3/16	.2521	.2498	.3128	.3122	.2490	.2481
LSI-0405-04	1/4	5/16	1/4	.2521	.2498	.3128	.3122	.2490	.2481
LSI-0405-05	1/4	5/16	5/16	.2521	.2498	.3128	.3122	.2490	.2481
LSI-0405-06	1/4	5/16	3/8	.2521	.2498	.3128	.3122	.2490	.2481
LSI-0405-08	1/4	5/16	1/2	.2521	.2498	.3128	.3122	.2490	.2481
LSI-0405-11	1/4	5/16	11/16	.2521	.2498	.3128	.3122	.2490	.2481
LSI-0506-04	5/16	3/8	1/4	.3148	.3125	.3753	.3747	.3115	.3106
LSI-0506-06	5/16	3/8	3/8	.3148	.3125	.3753	.3747	.3115	.3106
LSI-0506-08	5/16	3/8	1/2	.3148	.3125	.3753	.3747	.3115	.3106
LSI-0506-12	5/16	3/8	3/4	.3148	.3125	.3753	.3747	.3115	.3106
LSI-0607-04	3/8	15/32	1/4	.3773	.3750	.4691	.4684	.3740	.3731
LSI-0607-06	3/8	15/32	3/8	.3773	.3750	.4691	.4684	.3740	.3731
LSI-0607-07	3/8	15/32	7/16	.3773	.3750	.4691	.4684	.3740	.3731
LSI-0607-08	3/8	15/32	1/2	.3773	.3750	.4691	.4684	.3740	.3731
LSI-0607-12	3/8	15/32	3/4	.3773	.3750	.4691	.4684	.3740	.3731
LSI-0608-12	3/8	1/2	3/4	.3783	.3760	.5007	.5000	.3750	.3741
LSI-0708-08	7/16	17/32	1/2	.4406	.4379	.5316	.5309	.4365	.4355
LSI-0809-03	1/2	19/32	3/16	.5030	.5003	.5941	.5934	.4990	.4980
LSI-0809-04	1/2	19/32	1/4	.5030	.5003	.5941	.5934	.4990	.4980
LSI-0809-06	1/2	19/32	3/8	.5030	.5003	.5941	.5934	.4990	.4980
LSI-0809-08	1/2	19/32	1/2	.5030	.5003	.5941	.5934	.4990	.4980
LSI-0809-10	1/2	19/32	5/8	.5030	.5003	.5941	.5934	.4990	.4980
LSI-0809-12	1/2	19/32	3/4	.5030	.5003	.5941	.5934	.4990	.4980
LSI-0809-16	1/2	19/32	1	.5030	.5003	.5941	.5934	.4990	.4980
LSI-0810-08	1/2	5/8	1/2	.5040	.5013	.6260	.6250	.5000	.4990
LSI-0810-10	1/2	5/8	5/8	.5040	.5013	.6260	.6250	.5000	.4990
LSI-0810-12	1/2	5/8	3/4	.5040	.5013	.6260	.6250	.5000	.4990
LSI-0810-16	1/2	5/8	1	.5040	.5013	.6260	.6250	.5000	.4990
LSI-0910-08	9/16	21/32	1/2	.5655	.5627	.6570	.6563	.5615	.5605
LSI-0910-12	9/16	21/32	3/4	.5655	.5627	.6570	.6563	.5615	.5605
LSI-1011-04	5/8	23/32	1/4	.6280	.6253	.7192	.7184	.6240	.6230
LSI-1011-06	5/8	23/32	3/8	.6280	.6253	.7192	.7184	.6240	.6230
LSI-1011-08	5/8	23/32	1/2	.6280	.6253	.7192	.7184	.6240	.6230
LSI-1011-10	5/8	23/32	5/8	.6280	.6253	.7192	.7184	.6240	.6230
LSI-1011-12	5/8	23/32	3/4	.6280	.6253	.7192	.7184	.6240	.6230

PDF: www.igus.com/iglide-pdfs
 CAD: www.igus.com/iglide-CAD
 RoHS info: www.igus.com/RoHS

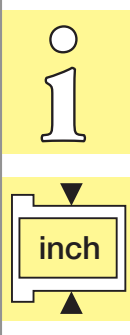
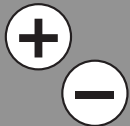

iglide® L280
Sleeve - Inch

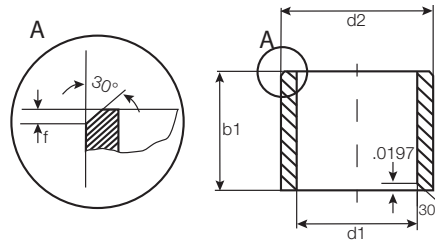

For tolerance values
please refer to page 7.4

Telephone 1-800-521-2747
Fax 1-401-438-7270

Internet: <http://www.igus.com>
email: sales@igus.com
QuickSpec: <http://www.igus.com/iglide-quickspec>

Part Number	d1	d2	b1	I.D. After Pressfit		Housing Bore		Shaft Size	
				Max.	Min.	Max.	Min.	Max.	Min.
LSI-1011-16	5/8	23/32	1	.6280	.6253	.7192	.7184	.6240	.6230
LSI-1112-12	11/16	25/32	3/4	.6906	.6879	.7817	.7809	.6865	.6855
LSI-1214-08	3/4	7/8	1/2	.7541	.7507	.8755	.8747	.7491	.7479
LSI-1214-12	3/4	7/8	3/4	.7541	.7507	.8755	.8747	.7491	.7479
LSI-1214-16	3/4	7/8	1	.7541	.7507	.8755	.8747	.7491	.7479
LSI-1214-24	3/4	7/8	1 1/2	.7541	.7507	.8755	.8747	.7491	.7479
LSI-1416-04	7/8	1	1/4	.8791	.8757	1.0005	.9997	.8741	.8729
LSI-1416-06	7/8	1	3/8	.8791	.8757	1.0005	.9997	.8741	.8729
LSI-1416-08	7/8	1	1/2	.8791	.8757	1.0005	.9997	.8741	.8729
LSI-1416-10	7/8	1	5/8	.8791	.8757	1.0005	.9997	.8741	.8729
LSI-1416-12	7/8	1	3/4	.8791	.8757	1.0005	.9997	.8741	.8729
LSI-1416-16	7/8	1	1	.8791	.8757	1.0005	.9997	.8741	.8729
LSI-1416-24	7/8	1	1 1/2	.8791	.8757	1.0005	.9997	.8741	.8729
LSI-1618-06	1	1 1/8	3/8	1.0041	1.0007	1.1255	1.1247	.9991	.9979
LSI-1618-08	1	1 1/8	1/2	1.0041	1.0007	1.1255	1.1247	.9991	.9979
LSI-1618-12	1	1 1/8	3/4	1.0041	1.0007	1.1255	1.1247	.9991	.9979
LSI-1618-16	1	1 1/8	1	1.0041	1.0007	1.1255	1.1247	.9991	.9979
LSI-1618-20	1	1 1/8	1 1/4	1.0041	1.0007	1.1255	1.1247	.9991	.9979
LSI-1618-22	1	1 1/8	1 3/8	1.0041	1.0007	1.1255	1.1247	.9991	.9979
LSI-1618-24	1	1 1/8	1 1/2	1.0041	1.0007	1.1255	1.1247	.9991	.9979
LSI-1820-12	1 1/8	1 9/32	3/4	1.1288	1.1254	1.2818	1.2808	1.1238	1.1226
LSI-2022-14	1 1/4	1 13/32	7/8	1.2548	1.2508	1.4068	1.4058	1.2488	1.2472
LSI-2022-16	1 1/4	1 13/32	1	1.2548	1.2508	1.4068	1.4058	1.2488	1.2472
LSI-2022-20	1 1/4	1 13/32	1 1/4	1.2548	1.2508	1.4068	1.4058	1.2488	1.2472
LSI-2022-24	1 1/4	1 13/32	1 1/2	1.2548	1.2508	1.4068	1.4058	1.2488	1.2472
LSI-2224-16	1 3/8	1 17/32	1	1.3798	1.3758	1.5318	1.5308	1.3738	1.3722
LSI-2224-24	1 3/8	1 17/32	1 1/2	1.3798	1.3758	1.5318	1.5308	1.3738	1.3722
LSI-2426-12	1 1/2	1 21/32	3/4	1.5048	1.5008	1.6568	1.6558	1.4988	1.4972
LSI-2426-16	1 1/2	1 21/32	1	1.5048	1.5008	1.6568	1.6558	1.4988	1.4972
LSI-2426-24	1 1/2	1 21/32	1 1/2	1.5048	1.5008	1.6568	1.6558	1.4988	1.4972
LSI-2426-44	1 1/2	1 21/32	2 3/4	1.5048	1.5008	1.6568	1.6558	1.4988	1.4972
LSI-2629-16	1 5/8	1 25/32	1	1.6297	1.6258	1.7818	1.7808	1.6238	1.6222
LSI-2629-20	1 5/8	1 25/32	1 1/4	1.6297	1.6258	1.7818	1.7808	1.6238	1.6222
LSI-2831-16	1 3/4	1 15/16	1	1.7547	1.7507	1.9381	1.9371	1.7487	1.7471
LSI-2831-24	1 3/4	1 15/16	1 1/2	1.7547	1.7507	1.9381	1.9371	1.7487	1.7471
LSI-2831-32	1 3/4	1 15/16	2	1.7547	1.7507	1.9381	1.9371	1.7487	1.7471
LSI-2831-48	1 3/4	1 15/16	3	1.7547	1.7507	1.9381	1.9371	1.7487	1.7471
LSI-3235-16	2	2 3/16	1	2.0057	2.0011	2.1883	2.1871	1.9981	1.9969
LSI-3235-24	2	2 3/16	1 1/2	2.0057	2.0011	2.1883	2.1871	1.9981	1.9969
LSI-3235-32	2	2 3/16	2	2.0057	2.0011	2.1883	2.1871	1.9981	1.9969
LSI-3639-32	2 1/4	2 7/16	2	2.2577	2.2531	2.4377	2.4365	2.2507	2.2489

iglide® Plain Bearings L280 - Flange, Inch

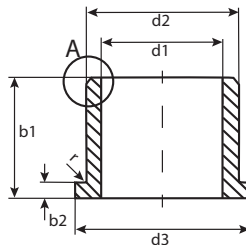
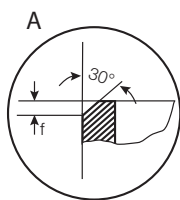

For tolerance values
please refer to page 7.4

$r = \max. .0197$

Part Number	d1	d2	b1	d3	b2 -.0055	I.D. After Pressfit		Housing Bore		Shaft Size	
						Max.	Min.	Max.	Min.	Max.	Min.
LFI-0203-03	1/8	3/16	3/16	.312	.032	.1269	.1251	.1878	.1873	.1243	.1236
LFI-0203-04	1/8	3/16	1/4	.312	.032	.1269	.1251	.1878	.1873	.1243	.1236
LFI-0203-06	1/8	3/16	3/8	.312	.032	.1269	.1251	.1878	.1873	.1243	.1236
LFI-0304-02	3/16	1/4	1/8	.375	.032	.1892	.1873	.2503	.2497	.1865	.1858
LFI-0304-04	3/16	1/4	1/4	.375	.032	.1892	.1873	.2503	.2497	.1865	.1858
LFI-0304-06	3/16	1/4	3/8	.375	.032	.1892	.1873	.2503	.2497	.1865	.1858
LFI-0304-08	3/16	1/4	1/2	.375	.032	.1892	.1873	.2503	.2497	.1865	.1858
LFI-0405-04	1/4	5/16	1/4	.500	.032	.2521	.2498	.3128	.3122	.2490	.2481
LFI-0405-05	1/4	5/16	5/16	.500	.032	.2521	.2498	.3128	.3122	.2490	.2481
LFI-0405-06	1/4	5/16	3/8	.500	.032	.2521	.2498	.3128	.3122	.2490	.2481
LFI-0405-08	1/4	5/16	1/2	.500	.032	.2521	.2498	.3128	.3122	.2490	.2481
LFI-0405-12	1/4	5/16	3/4	.500	.032	.2521	.2498	.3128	.3122	.2490	.2481
LFI-0506-04	5/16	3/8	1/4	.562	.032	.3148	.3125	.3753	.3747	.3115	.3106
LFI-0506-06	5/16	3/8	3/8	.562	.032	.3148	.3125	.3753	.3747	.3115	.3106
LFI-0506-08	5/16	3/8	1/2	.562	.032	.3148	.3125	.3753	.3747	.3115	.3106
LFI-0506-12	5/16	3/8	3/4	.562	.032	.3148	.3125	.3753	.3747	.3115	.3106
LFI-0607-04	3/8	15/32	1/4	.687	.046	.3773	.3750	.4691	.4684	.3740	.3731
LFI-0607-06	3/8	15/32	3/8	.687	.046	.3773	.3750	.4691	.4684	.3740	.3731
LFI-0607-08	3/8	15/32	1/2	.687	.046	.3773	.3750	.4691	.4684	.3740	.3731
LFI-0607-12	3/8	15/32	3/4	.687	.046	.3773	.3750	.4691	.4684	.3740	.3731
LFI-0607-14	3/8	15/32	7/8	.687	.046	.3773	.3750	.4691	.4684	.3740	.3731
LFI-0708-08	7/16	17/32	1/2	.750	.046	.4406	.4379	.5316	.5309	.4365	.4355
LFI-0809-04	1/2	19/32	1/4	.875	.046	.5030	.5003	.5941	.5934	.4990	.4980
LFI-0809-06	1/2	19/32	3/8	.875	.046	.5030	.5003	.5941	.5934	.4990	.4980
LFI-0809-08	1/2	19/32	1/2	.875	.046	.5030	.5003	.5941	.5934	.4990	.4980
LFI-0809-12	1/2	19/32	3/4	.875	.046	.5030	.5003	.5941	.5934	.4990	.4980
LFI-0809-16	1/2	19/32	1	.875	.046	.5030	.5003	.5941	.5934	.4990	.4980
LFI-1011-045	5/8	23/32	9/32	.937	.046	.6280	.6253	.7192	.7184	.6240	.6230
LFI-1011-08	5/8	23/32	1/2	.937	.046	.6280	.6253	.7192	.7184	.6240	.6230
LFI-1011-12	5/8	23/32	3/4	.937	.046	.6280	.6253	.7192	.7184	.6240	.6230
LFI-1011-16	5/8	23/32	1	.937	.046	.6280	.6253	.7192	.7184	.6240	.6230
LFI-1011-24	5/8	23/32	1 1/2	.937	.046	.6280	.6253	.7192	.7184	.6240	.6230
LFI-1214-08	3/4	7/8	1/2	1.125	.062	.7541	.7507	.8755	.8747	.7491	.7479
LFI-1214-10	3/4	7/8	5/8	1.125	.062	.7541	.7507	.8755	.8747	.7491	.7479
LFI-1214-12	3/4	7/8	3/4	1.125	.062	.7541	.7507	.8755	.8747	.7491	.7479
LFI-1214-16	3/4	7/8	1	1.125	.062	.7541	.7507	.8755	.8747	.7491	.7479
LFI-1214-24	3/4	7/8	1 1/2	1.125	.062	.7541	.7507	.8755	.8747	.7491	.7479
LFI-1416-04	7/8	1	1/4	1.250	.062	.8791	.8757	1.0005	.9997	.8741	.8729
LFI-1416-075	7/8	1	15/32	1.250	.062	.8791	.8757	1.0005	.9997	.8741	.8729
LFI-1416-08	7/8	1	1/2	1.250	.062	.8791	.8757	1.0005	.9997	.8741	.8729
LFI-1416-115	7/8	1	23/32	1.250	.062	.8791	.8757	1.0005	.9997	.8741	.8729

iglide® L280
Flange - Inch

PDF: www.igus.com/iglide-pdfs
CAD: www.igus.com/iglide-CAD
RoHS info: www.igus.com/RoHS

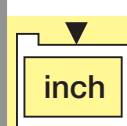
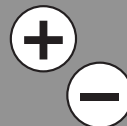

L280



iglide® Plain Bearings L280 - Flange, Inch

iglide® L280
Flange - Inch

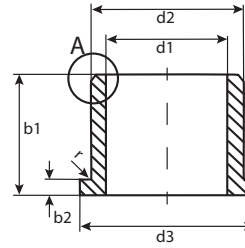
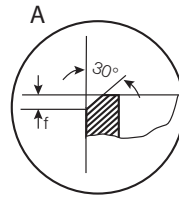

For tolerance values
please refer to page 7.4

r = max. .0197

Telephone 1-800-521-2747
Fax 1-401-438-7270

Internet: <http://www.igus.com>
email: sales@igus.com
QuickSpec: <http://www.igus.com/iglide-quickspec>

Part Number	d1	d2	b1	d3	b2 -.0055	I.D. After Pressfit		Housing Bore		Shaft Size	
						Max.	Min.	Max.	Min.	Max.	Min.
LFI-1416-12	7/8	1	3/4	1.250	.062	.8791	.8757	1.0005	.9997	.8741	.8729
LFI-1416-16	7/8	1	1	1.250	.062	.8791	.8757	1.0005	.9997	.8741	.8729
LFI-1416-20	7/8	1	1 1/4	1.250	.062	.8791	.8757	1.0005	.9997	.8741	.8729
LFI-1416-24	7/8	1	1 1/2	1.250	.062	.8791	.8757	1.0005	.9997	.8741	.8729
LFI-141618-08	7/8	1	1/2	1.125	.062	.8791	.8757	1.0005	.9997	.8741	.8729
LFI-141618-10	7/8	1	5/8	1.125	.062	.8791	.8757	1.0005	.9997	.8741	.8729
LFI-141620-11	7/8	1	11/16	1.250	.062	.8791	.8757	1.0005	.9997	.8741	.8729
LFI-1618-08	1	1 1/8	1/2	1.375	.062	1.0041	1.0007	1.1255	1.1247	.9991	.9979
LFI-1618-12	1	1 1/8	3/4	1.375	.062	1.0041	1.0007	1.1255	1.1247	.9991	.9979
LFI-1618-16	1	1 1/8	1	1.375	.062	1.0041	1.0007	1.1255	1.1247	.9991	.9979
LFI-1618-20	1	1 1/8	1 1/4	1.375	.062	1.0041	1.0007	1.1255	1.1247	.9991	.9979
LFI-1618-24	1	1 1/8	1 1/2	1.375	.062	1.0041	1.0007	1.1255	1.1247	.9991	.9979
LFI-1620-08	1	1 9/32	1/2	1.562	.062	1.0041	1.0007	1.2818	1.2808	.9991	.9979
LFI-1820-08	1 1/8	1 9/32	1/2	1.562	.078	1.1288	1.1254	1.2818	1.2808	1.1238	1.1226
LFI-1820-12	1 1/8	1 9/32	3/4	1.562	.078	1.1288	1.1254	1.2818	1.2808	1.1238	1.1226
LFI-1820-24	1 1/8	1 9/32	1 1/2	1.562	.078	1.1288	1.1254	1.2818	1.2808	1.1238	1.1226
LFI-2022-12	1 1/4	1 13/32	3/4	1.687	.078	1.2548	1.2508	1.4068	1.4058	1.2488	1.2472
LFI-2022-14	1 1/4	1 13/32	7/8	1.687	.078	1.2548	1.2508	1.4068	1.4058	1.2488	1.2472
LFI-2022-16	1 1/4	1 13/32	1	1.687	.078	1.2548	1.2508	1.4068	1.4058	1.2488	1.2472
LFI-2022-20	1 1/4	1 13/32	1 1/4	1.687	.078	1.2548	1.2508	1.4068	1.4058	1.2488	1.2472
LFI-2022-24	1 1/4	1 13/32	1 1/2	1.687	.078	1.2548	1.2508	1.4068	1.4058	1.2488	1.2472
LFI-2224-16	1 3/8	1 17/32	1	1.875	.078	1.3798	1.3758	1.5318	1.5308	1.3738	1.3722
LFI-2426-12	1 1/2	1 21/32	3/4	2.000	.078	1.5048	1.5008	1.6568	1.6558	1.4988	1.4972
LFI-2426-16	1 1/2	1 21/32	1	2.000	.078	1.5048	1.5008	1.6568	1.6558	1.4988	1.4972
LFI-2426-24	1 1/2	1 21/32	1 1/2	2.000	.078	1.5048	1.5008	1.6568	1.6558	1.4988	1.4972
LFI-2831-16	1 3/4	1 15/16	1	2.375	.093	1.7547	1.7507	1.9381	1.9371	1.7487	1.7471
LFI-2831-24	1 3/4	1 15/16	1 1/2	2.375	.093	1.7547	1.7507	1.9381	1.9371	1.7487	1.7471
LFI-2831-32	1 3/4	1 15/16	2	2.375	.093	1.7547	1.7507	1.9381	1.9371	1.7487	1.7471
LFI-3235-16	2	2 3/16	1	2.625	.093	2.0059	2.0012	2.1883	2.1871	1.9981	1.9969
LFI-3235-24	2	2 3/16	1 1/2	2.625	.093	2.0059	2.0012	2.1883	2.1871	1.9981	1.9969
LFI-3235-32	2	2 3/16	2	2.625	.093	2.0059	2.0012	2.1883	2.1871	1.9981	1.9969

iglide® Plain Bearings
L280 - Thrust Washer, Inch

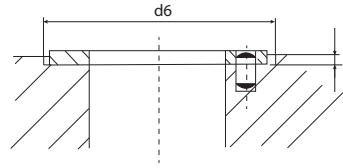
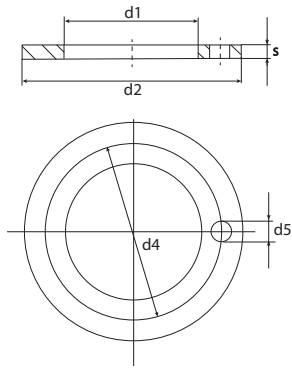

Part Number	d1 +.010	d2 -.010	s -.0020	d4 +-.005	d5 .015 +.005	h +.008	d6 +.005
LTI-0610-01	.375	.625	.040	**	**	**	.625
LTI-0814-01	.500	.875	.0585	.692	.067	.040	.875
LTI-1018-01	.625	1.125	.0585	.880	.099	.040	1.125
LTI-1220-01	.750	1.250	.0585	1.005	.099	.040	1.250
LTI-1424-01	.875	1.500	.0585	1.192	.130	.040	1.500
LTI-1628-01	1.000	1.750	.0585	1.380	.130	.040	1.750
LTI-2034-01	1.250	2.125	.0585	1.692	.161	.040	2.125
LTI-2440-01	1.500	2.500	.0585	2.005	.192	.040	2.500
LTI-2844-01	1.750	2.750	.0585	2.255	.192	.040	2.750
LTI-3248-01	2.000	3.000	.0895	2.505	.192	.070	3.000

** Designed without fixing bore

iglide® L280
Thrust Washer - Inch

PDF: www.igus.com/iglide-pdfs
CAD: www.igus.com/iglide-CAD
RoHS info: www.igus.com/RoHS



iglide® L280
Sleeve - MM

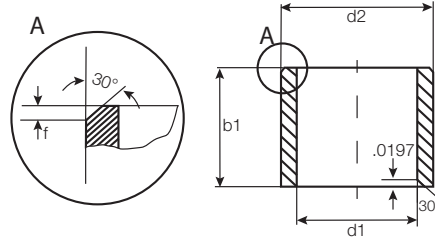

For tolerance values
please refer to page 7.4

Dimensions according to ISO 3547-1 and special dimensions

Part Number	d1	d1-Tolerance after pressfit in Ø H7	d2	b1 h13	I.D. After Pressfit		Housing Bore		Shaft Size	
					Max.	Min.	Max.	Min.	Max.	Min.
LSM-0203-03	2.0	+0.014 +0.054	3.5	3.0	2.054	2.014	3.508	3.500	2.000	1.975
LSM-0204-03	2.5	+0.014 +0.054	4.0	3.0	2.554	2.514	4.012	4.000	2.500	2.475
LSM-0304-03	3.0	+0.014 +0.054	4.5	3.0	3.054	3.014	4.512	4.500	3.000	2.975
LSM-0304-05	3.0	+0.014 +0.054	4.5	5.0	3.054	3.014	4.512	4.500	3.000	2.975
LSM-0304-06	3.0	+0.014 +0.054	4.5	6.0	3.054	3.014	4.512	4.500	3.000	2.975
LSM-0405-04	4.0	+0.020 +0.068	5.5	4.0	4.068	4.020	5.512	5.500	4.000	3.970
LSM-0405-06	4.0	+0.020 +0.068	5.5	6.0	4.068	4.020	5.512	5.500	4.000	3.970
LSM-0405-08	4.0	+0.020 +0.068	5.5	8.0	4.068	4.020	5.512	5.500	4.000	3.970
LSM-0405-10	4.0	+0.020 +0.068	5.5	10.0	4.068	4.020	5.512	5.500	4.000	3.970
LSM-0507-05	5.0	+0.020 +0.068	7.0	5.0	5.068	5.020	7.015	7.000	5.000	4.970
LSM-0507-08	5.0	+0.020 +0.068	7.0	8.0	5.068	5.020	7.015	7.000	5.000	4.970
LSM-0507-10	5.0	+0.020 +0.068	7.0	10.0	5.068	5.020	7.015	7.000	5.000	4.970
LSM-0607-14	6.0	+0.010 +0.040	7.0	14.0	6.040	6.010	7.015	7.000	6.000	5.970
LSM-0608-06	6.0	+0.020 +0.068	8.0	6.0	6.068	6.020	8.015	8.000	6.000	5.970
LSM-0608-08	6.0	+0.020 +0.068	8.0	8.0	6.068	6.020	8.015	8.000	6.000	5.970
LSM-0608-09	6.0	+0.020 +0.068	8.0	9.5	6.068	6.020	8.015	8.000	6.000	5.970
LSM-0608-10	6.0	+0.020 +0.068	8.0	10.0	6.068	6.020	8.015	8.000	6.000	5.970
LSM-0608-11	6.0	+0.020 +0.068	8.0	11.8	6.068	6.020	8.015	8.000	6.000	5.970
LSM-0608-13	6.0	+0.020 +0.068	8.0	13.8	6.068	6.020	8.015	8.000	6.000	5.970
LSM-0709-09	7.0	+0.025 +0.083	9.0	9.0	7.083	7.025	9.015	9.000	7.000	6.964
LSM-0709-12	7.0	+0.025 +0.083	9.0	12.0	7.083	7.025	9.015	9.000	7.000	6.964
LSM-0810-06	8.0	+0.025 +0.083	10.0	6.0	8.083	8.025	10.015	10.000	8.000	7.964
LSM-0810-08	8.0	+0.025 +0.083	10.0	8.0	8.083	8.025	10.015	10.000	8.000	7.964
LSM-0810-10	8.0	+0.025 +0.083	10.0	10.0	8.083	8.025	10.015	10.000	8.000	7.964
LSM-0810-12	8.0	+0.025 +0.083	10.0	12.0	8.083	8.025	10.015	10.000	8.000	7.964
LSM-0810-13	8.0	+0.025 +0.083	10.0	13.8	8.083	8.025	10.015	10.000	8.000	7.964
LSM-0810-15	8.0	+0.025 +0.083	10.0	15.0	8.083	8.025	10.015	10.000	8.000	7.964
LSM-0810-16	8.0	+0.025 +0.083	10.0	16.0	8.083	8.025	10.015	10.000	8.000	7.964
LSM-0810-20	8.0	+0.025 +0.083	10.0	20.0	8.083	8.025	10.015	10.000	8.000	7.964
LSM-0810-21	8.0	+0.025 +0.083	10.0	21.0	8.083	8.025	10.015	10.000	8.000	7.964
LSM-0911-06	9.0	+0.025 +0.083	11.0	6.0	9.083	9.025	11.018	11.000	9.000	8.964
LSM-1012-04	10.0	+0.025 +0.083	12.0	4.0	10.083	10.025	12.018	12.000	10.000	9.964
LSM-1012-06	10.0	+0.025 +0.083	12.0	6.0	10.083	10.025	12.018	12.000	10.000	9.964
LSM-1012-08	10.0	+0.025 +0.083	12.0	8.0	10.083	10.025	12.018	12.000	10.000	9.964
LSM-1012-09	10.0	+0.025 +0.083	12.0	9.0	10.083	10.025	12.018	12.000	10.000	9.964
LSM-1012-10	10.0	+0.025 +0.083	12.0	10.0	10.083	10.025	12.018	12.000	10.000	9.964
LSM-1012-12	10.0	+0.025 +0.083	12.0	12.0	10.083	10.025	12.018	12.000	10.000	9.964
LSM-1012-15	10.0	+0.025 +0.083	12.0	15.0	10.083	10.025	12.018	12.000	10.000	9.964
LSM-1012-17	10.0	+0.025 +0.083	12.0	17.0	10.083	10.025	12.018	12.000	10.000	9.964
LSM-1012-20	10.0	+0.025 +0.083	12.0	20.0	10.083	10.025	12.018	12.000	10.000	9.964
LSM-1012-25.5	10.0	+0.025 +0.083	12.0	25.5	10.083	10.025	12.018	12.000	10.000	9.964

Telephone 1-800-521-2747
Fax 1-401-438-7270

Internet: <http://www.igus.com>
email: sales@igus.com
QuickSpec: <http://www.igus.com/iglide-quickspec>

iglide® Plain Bearings L280 - Sleeve, MM

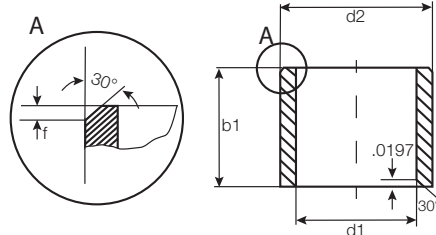

For tolerance values
please refer to page 7.4

Dimensions according to ISO 3547-1 and special dimensions

Part Number	d1	d1-Tolerance after pressfit in \varnothing H7	d2	b1 h13	I.D. After Pressfit		Housing Bore		Shaft Size	
					Max.	Min.	Max.	Min.	Max.	Min.
LSM-1113-08	11.0	+0.032 +0.102	13.0	8.0	11.102	11.032	13.018	13.000	11.000	10.964
LSM-1214-04	12.0	+0.032 +0.102	14.0	4.0	12.102	12.032	14.018	14.000	12.000	11.957
LSM-1214-05	12.0	+0.032 +0.102	14.0	5.0	12.102	12.032	14.018	14.000	12.000	11.957
LSM-1214-06	12.0	+0.032 +0.102	14.0	6.0	12.102	12.032	14.018	14.000	12.000	11.957
LSM-1214-08	12.0	+0.032 +0.102	14.0	8.0	12.102	12.032	14.018	14.000	12.000	11.957
LSM-1214-10	12.0	+0.032 +0.102	14.0	10.0	12.102	12.032	14.018	14.000	12.000	11.957
LSM-1214-12	12.0	+0.032 +0.102	14.0	12.0	12.102	12.032	14.018	14.000	12.000	11.957
LSM-1214-15	12.0	+0.032 +0.102	14.0	15.0	12.102	12.032	14.018	14.000	12.000	11.957
LSM-1214-20	12.0	+0.032 +0.102	14.0	20.0	12.102	12.032	14.018	14.000	12.000	11.957
LSM-1214-25	12.0	+0.032 +0.102	14.0	25.0	12.102	12.032	14.018	14.000	12.000	11.957
LSM-1315-07	13.0	+0.032 +0.102	15.0	7.0	13.102	13.032	15.018	15.000	13.000	12.957
LSM-1315-10	13.0	+0.032 +0.102	15.0	10.0	13.102	13.032	15.018	15.000	13.000	12.957
LSM-1315-15	13.0	+0.032 +0.102	15.0	15.0	13.102	13.032	15.018	15.000	13.000	12.957
LSM-1315-20	13.0	+0.032 +0.102	15.0	20.0	13.102	13.032	15.018	15.000	13.000	12.957
LSM-1416-07	14.0	+0.032 +0.102	16.0	7.5	14.102	14.032	16.018	16.000	14.000	13.957
LSM-1416-10	14.0	+0.032 +0.102	16.0	10.0	14.102	14.032	16.018	16.000	14.000	13.957
LSM-1416-15	14.0	+0.032 +0.102	16.0	15.0	14.102	14.032	16.018	16.000	14.000	13.957
LSM-1416-20	14.0	+0.032 +0.102	16.0	20.0	14.102	14.032	16.018	16.000	14.000	13.957
LSM-1416-25	14.0	+0.032 +0.102	16.0	25.0	14.102	14.032	16.018	16.000	14.000	13.957
LSM-1416-33	14.0	+0.032 +0.102	16.0	33.0	14.102	14.032	16.018	16.000	14.000	13.957
LSM-1517-10	15.0	+0.032 +0.102	17.0	10.0	15.102	15.032	17.018	17.000	15.000	14.957
LSM-1517-15	15.0	+0.032 +0.102	17.0	15.0	15.102	15.032	17.018	17.000	15.000	14.957
LSM-1517-20	15.0	+0.032 +0.102	17.0	20.0	15.102	15.032	17.018	17.000	15.000	14.957
LSM-1517-25	15.0	+0.032 +0.102	17.0	25.0	15.102	15.032	17.018	17.000	15.000	14.957
LSM-1618-07	16.0	+0.032 +0.102	18.0	7.0	16.102	16.032	18.018	18.000	16.000	15.957
LSM-1618-08	16.0	+0.032 +0.102	18.0	8.0	16.102	16.032	18.018	18.000	16.000	15.957
LSM-1618-11	16.0	+0.032 +0.102	18.0	11.5	16.102	16.032	18.018	18.000	16.000	15.957
LSM-1618-12	16.0	+0.032 +0.102	18.0	12.0	16.102	16.032	18.018	18.000	16.000	15.957
LSM-1618-15	16.0	+0.032 +0.102	18.0	15.0	16.102	16.032	18.018	18.000	16.000	15.957
LSM-1618-20	16.0	+0.032 +0.102	18.0	20.0	16.102	16.032	18.018	18.000	16.000	15.957
LSM-1618-25	16.0	+0.032 +0.102	18.0	25.0	16.102	16.032	18.018	18.000	16.000	15.957
LSM-1618-30	16.0	+0.032 +0.102	18.0	30.0	16.102	16.032	18.018	18.000	16.000	15.957
LSM-1618-35	16.0	+0.032 +0.102	18.0	35.0	16.102	16.032	18.018	18.000	16.000	15.957
LSM-1618-42	16.0	+0.032 +0.102	18.0	42.0	16.102	16.032	18.018	18.000	16.000	15.957
LSM-1618-45	16.0	+0.032 +0.102	18.0	45.0	16.102	16.032	18.018	18.000	16.000	15.957
LSM-1820-12	18.0	+0.032 +0.102	20.0	12.0	18.102	18.032	20.021	20.000	18.000	17.957
LSM-1820-15	18.0	+0.032 +0.102	20.0	15.0	18.102	18.032	20.021	20.000	18.000	17.957
LSM-1820-20	18.0	+0.032 +0.102	20.0	20.0	18.102	18.032	20.021	20.000	18.000	17.957
LSM-1820-25	18.0	+0.032 +0.102	20.0	25.0	18.102	18.032	20.021	20.000	18.000	17.957
LSM-1820-33	18.0	+0.032 +0.102	20.0	33.0	18.102	18.032	20.021	20.000	18.000	17.957
LSM-1820-35	18.0	+0.032 +0.102	20.0	35.0	18.102	18.032	20.021	20.000	18.000	17.957

iglide® L280
Sleeve - MM

PDF: www.igus.com/iglide-pdfs
CAD: www.igus.com/iglide-CAD
RoHS info: www.igus.com/RoHS



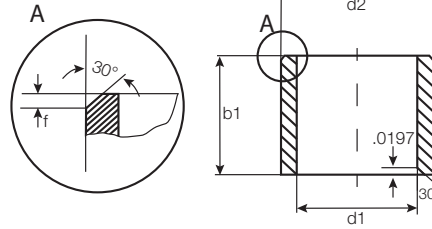

For tolerance values
please refer to page 7.4

Dimensions according to ISO 3547-1 and special dimensions

Part Number	d1	d1-Tolerance after pressfit in Ø H7	d2	b1 h13	I.D. After Pressfit		Housing Bore		Shaft Size	
					Max.	Min.	Max.	Min.	Max.	Min.
LSM-1922-28	19.0	+0.040 +0.124	22.0	28.0	19.124	19.040	22.021	22.000	19.000	18.957
LSM-2022-11	20.0	+0.040 +0.124	22.0	11.5	20.124	20.040	22.021	22.000	20.000	19.948
LSM-2022-12	20.0	+0.040 +0.124	22.0	12.0	20.124	20.040	22.021	22.000	20.000	19.948
LSM-2022-15	20.0	+0.040 +0.124	22.0	15.0	20.124	20.040	22.021	22.000	20.000	19.948
LSM-2022-20	20.0	+0.040 +0.124	22.0	20.0	20.124	20.040	22.021	22.000	20.000	19.948
LSM-2022-30	20.0	+0.040 +0.124	22.0	30.0	20.124	20.040	22.021	22.000	20.000	19.948
LSM-2023-15	20.0	+0.040 +0.124	23.0	15.0	20.124	20.040	23.021	23.000	20.000	19.948
LSM-2023-20	20.0	+0.040 +0.124	23.0	20.0	20.124	20.040	23.021	23.000	20.000	19.948
LSM-2023-23	20.0	+0.040 +0.124	23.0	23.0	20.124	20.040	23.021	23.000	20.000	19.948
LSM-2023-25	20.0	+0.040 +0.124	23.0	25.0	20.124	20.040	23.021	23.000	20.000	19.948
LSM-2023-30	20.0	+0.040 +0.124	23.0	30.0	20.124	20.040	23.021	23.000	20.000	19.948
LSM-2224-15	22.0	+0.040 +0.124	24.0	15.0	22.124	22.040	24.021	24.000	22.000	21.948
LSM-2224-20	22.0	+0.040 +0.124	24.0	20.0	22.124	22.040	24.021	24.000	22.000	21.948
LSM-2224-30	22.0	+0.040 +0.124	24.0	30.0	22.124	22.040	24.021	24.000	22.000	21.948
LSM-2224-35	22.0	+0.040 +0.124	24.0	35.0	22.124	22.040	24.021	24.000	22.000	21.948
LSM-2225-15	22.0	+0.040 +0.124	25.0	15.0	22.124	22.040	25.021	25.000	22.000	21.948
LSM-2225-20	22.0	+0.040 +0.124	25.0	20.0	22.124	22.040	25.021	25.000	22.000	21.948
LSM-2225-25	22.0	+0.040 +0.124	25.0	25.0	22.124	22.040	25.021	25.000	22.000	21.948
LSM-2225-30	22.0	+0.040 +0.124	25.0	30.0	22.124	22.040	25.021	25.000	22.000	21.948
LSM-2427-15	24.0	+0.040 +0.124	27.0	15.0	24.124	24.040	27.021	27.000	24.000	23.948
LSM-2427-20	24.0	+0.040 +0.124	27.0	20.0	24.124	24.040	27.021	27.000	24.000	23.948
LSM-2427-25	24.0	+0.040 +0.124	27.0	25.0	24.124	24.040	27.021	27.000	24.000	23.948
LSM-2427-30	24.0	+0.040 +0.124	27.0	30.0	24.124	24.040	27.021	27.000	24.000	23.948
LSM-2528-12	25.0	+0.040 +0.124	28.0	12.0	25.124	25.040	28.021	28.000	25.000	24.948
LSM-2528-14	25.0	+0.040 +0.124	28.0	14.0	25.124	25.040	28.021	28.000	25.000	24.948
LSM-2528-15	25.0	+0.040 +0.124	28.0	15.0	25.124	25.040	28.021	28.000	25.000	24.948
LSM-2528-20	25.0	+0.040 +0.124	28.0	20.0	25.124	25.040	28.021	28.000	25.000	24.948
LSM-2528-25	25.0	+0.040 +0.124	28.0	25.0	25.124	25.040	28.021	28.000	25.000	24.948
LSM-2528-30	25.0	+0.040 +0.124	28.0	30.0	25.124	25.040	28.021	28.000	25.000	24.948
LSM-2630-16	26.0	+0.040 +0.124	30.0	16.0	26.124	26.040	30.025	30.000	26.000	25.948
LSM-2630-25	26.0	+0.040 +0.124	30.0	25.0	26.124	26.040	30.025	30.000	26.000	25.948
LSM-2830-10	28.0	+0.040 +0.124	30.0	10.0	28.124	28.040	30.025	30.000	28.000	27.948
LSM-2831-10	28.0	+0.040 +0.124	31.0	10.0	28.124	28.040	31.025	31.000	28.000	27.948
LSM-2832-20	28.0	+0.040 +0.124	32.0	20.0	28.124	28.040	32.025	32.000	28.000	27.948
LSM-2832-25	28.0	+0.040 +0.124	32.0	25.0	28.124	28.040	32.025	32.000	28.000	27.948
LSM-2832-30	28.0	+0.040 +0.124	32.0	30.0	28.124	28.040	32.025	32.000	28.000	27.948
LSM-3034-16	30.0	+0.040 +0.124	34.0	16.0	30.124	30.040	34.025	34.000	30.000	29.948
LSM-3034-20	30.0	+0.040 +0.124	34.0	20.0	30.124	30.040	34.025	34.000	30.000	29.948
LSM-3034-24	30.0	+0.040 +0.124	34.0	24.0	30.124	30.040	34.025	34.000	30.000	29.948
LSM-3034-25	30.0	+0.040 +0.124	34.0	25.0	30.124	30.040	34.025	34.000	30.000	29.948

iglide® Plain Bearings L280 - Sleeve, MM



iglide® L280
Sleeve - MM

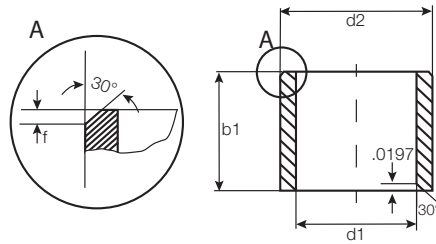

For tolerance values
please refer to page 7.4

Dimensions according to ISO 3547-1 and special dimensions

Part Number	d1	d1-Tolerance after pressfit in Ø H7	d2	b1 h13	I.D. After Pressfit		Housing Bore		Shaft Size	
					Max.	Min.	Max.	Min.	Max.	Min.
LSM-3034-30	30.0	+0.040 +0.124	34.0	30.0	30.124	30.040	34.025	34.000	30.000	29.948
LSM-3034-36	30.0	+0.040 +0.124	34.0	36.0	30.124	30.040	34.025	34.000	30.000	29.948
LSM-3034-38	30.0	+0.040 +0.124	34.0	38.0	30.124	30.040	34.025	34.000	30.000	29.948
LSM-3034-40	30.0	+0.040 +0.124	34.0	40.0	30.124	30.040	34.025	34.000	30.000	29.948
LSM-3034-47	30.0	+0.040 +0.124	34.0	47.0	30.124	30.040	34.025	34.000	30.000	29.948
LSM-3236-20	32.0	+0.050 +0.150	36.0	20.0	32.150	32.050	36.025	36.000	32.000	31.938
LSM-3236-25	32.0	+0.050 +0.150	36.0	25.0	32.150	32.050	36.025	36.000	32.000	31.938
LSM-3236-30	32.0	+0.050 +0.150	36.0	30.0	32.150	32.050	36.025	36.000	32.000	31.938
LSM-3236-40	32.0	+0.050 +0.150	36.0	40.0	32.150	32.050	36.025	36.000	32.000	31.938
LSM-3539-20	35.0	+0.050 +0.150	39.0	20.0	35.150	35.050	39.025	39.000	35.000	34.938
LSM-3539-30	35.0	+0.050 +0.150	39.0	30.0	35.150	35.050	39.025	39.000	35.000	34.938
LSM-3539-40	35.0	+0.050 +0.150	39.0	40.0	35.150	35.050	39.025	39.000	35.000	34.938
LSM-3539-50	35.0	+0.050 +0.150	39.0	50.0	35.150	35.050	39.025	39.000	35.000	34.938
LSM-4044-20	40.0	+0.050 +0.150	44.0	20.0	40.150	40.050	44.025	44.000	40.000	39.938
LSM-4044-30	40.0	+0.050 +0.150	44.0	30.0	40.150	40.050	44.025	44.000	40.000	39.938
LSM-4044-40	40.0	+0.050 +0.150	44.0	40.0	40.150	40.050	44.025	44.000	40.000	39.938
LSM-4044-50	40.0	+0.050 +0.150	44.0	50.0	40.150	40.050	44.025	44.000	40.000	39.938
LSM-4550-30	45.0	+0.050 +0.150	50.0	30.0	45.150	45.050	50.025	50.000	45.000	44.938
LSM-4550-50	45.0	+0.050 +0.150	50.0	50.0	45.150	45.050	50.025	50.000	45.000	44.938
LSM-5055-20	50.0	+0.050 +0.150	55.0	20.0	50.150	50.050	55.030	55.000	50.000	49.938
LSM-5055-30	50.0	+0.050 +0.150	55.0	30.0	50.150	50.050	55.030	55.000	50.000	49.938
LSM-5055-40	50.0	+0.050 +0.150	55.0	40.0	50.150	50.050	55.030	55.000	50.000	49.938
LSM-5055-50	50.0	+0.050 +0.150	55.0	50.0	50.150	50.050	55.030	55.000	50.000	49.938
LSM-5560-40	55.0	+0.060 +0.180	60.0	40.0	55.160	55.060	60.030	60.000	55.000	54.926
LSM-5560-60	55.0	+0.060 +0.180	60.0	60.0	55.160	55.060	60.030	60.000	55.000	54.926
LSM-6065-30	60.0	+0.060 +0.180	65.0	30.0	60.180	60.060	65.030	65.000	60.000	59.926
LSM-6065-60	60.0	+0.060 +0.180	65.0	60.0	60.180	60.060	65.030	65.000	60.000	59.926
LSM-6570-60	65.0	+0.060 +0.180	70.0	60.0	65.180	65.060	70.030	70.000	65.000	64.926
LSM-7075-60	70.0	+0.060 +0.180	75.0	60.0	70.180	70.060	75.030	75.000	70.000	69.926
LSM-7580-100	75.0	+0.060 +0.180	80.0	100.0	75.180	75.060	80.030	80.000	75.000	74.926
LSM-8085-100	80.0	+0.060 +0.180	85.0	100.0	80.180	80.060	85.030	85.000	80.000	79.926
LSM-9095-100	90.0	+0.072 +0.212	95.0	100.0	90.212	90.072	95.035	95.000	90.000	89.913
LSM-100105-100	100.0	+0.072 +0.212	105.0	100.0	100.212	100.072	105.035	105.000	100.000	99.913

PDF: www.igus.com/iglide-pdfs
CAD: www.igus.com/iglide-CAD
RoHS info: www.igus.com/RoHS

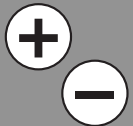

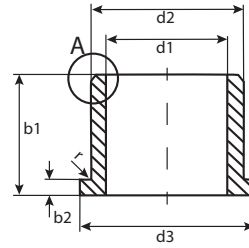
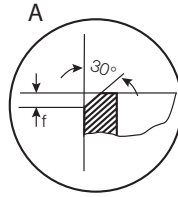

For tolerance values
please refer to page 7.4

r = max. 0.5

Dimensions according to ISO 3547-1 and special dimensions

Part Number	d1 ¹⁾ d1-Tolerance		d2	d3	b1	b2	I.D. After Pressfit		Housing Bore		Shaft Size	
	After Pressfit in Ø H7						Max.	Min.	Max.	Min.	Max.	Min.
LFM-0304-03	3.0	+0.014 +0.054	4.5	7.5	3.0	0.75	3.054	3.014	4.512	4.500	3.000	2.975
LFM-0304-05	3.0	+0.014 +0.054	4.5	7.5	5.0	0.75	3.054	3.014	4.512	4.500	3.000	2.975
LFM-0405-03	4.0	+0.020 +0.068	5.5	9.5	3.0	0.75	4.068	4.020	5.512	5.500	4.000	3.970
LFM-0405-04	4.0	+0.020 +0.068	5.5	9.5	4.0	0.75	4.068	4.020	5.512	5.500	4.000	3.970
LFM-0405-06	4.0	+0.020 +0.068	5.5	9.5	6.0	0.75	4.068	4.020	5.512	5.500	4.000	3.970
LFM-0506-08	5.0	+0.010 +0.040	6.0	10.0	8.0	0.5	5.040	5.010	6.012	6.000	5.000	4.970
LFM-0507-04	5.0	+0.020 +0.068	7.0	11.0	4.0	1.0	5.068	5.020	7.015	7.000	5.000	4.970
LFM-0507-05	5.0	+0.020 +0.068	7.0	11.0	5.0	1.0	5.068	5.020	7.015	7.000	5.000	4.970
LFM-0608-04	6.0	+0.020 +0.068	8.0	12.0	4.0	1.0	6.068	6.020	8.015	8.000	6.000	5.970
LFM-0608-06	6.0	+0.020 +0.068	8.0	12.0	6.0	1.0	6.068	6.020	8.015	8.000	6.000	5.970
LFM-0608-08	6.0	+0.020 +0.068	8.0	12.0	8.0	1.0	6.068	6.020	8.015	8.000	6.000	5.970
LFM-0608-10	6.0	+0.020 +0.068	8.0	12.0	10.0	1.0	6.068	6.020	8.015	8.000	6.000	5.970
LFM-0608-15	6.0	+0.020 +0.068	8.0	12.0	15.0	1.0	6.068	6.020	8.015	8.000	6.000	5.970
LFM-0709-12	7.0	+0.025 +0.083	9.0	15.0	12.0	1.0	7.083	7.025	9.015	9.000	7.000	6.964
LFM-0810-02	8.0	+0.025 +0.083	10.0	15.0	2.7	1.0	8.083	8.025	10.015	10.000	8.000	7.964
LFM-0810-05	8.0	+0.025 +0.083	10.0	15.0	5.5	1.0	8.083	8.025	10.015	10.000	8.000	7.964
LFM-0810-07	8.0	+0.025 +0.083	10.0	15.0	7.5	1.0	8.083	8.025	10.015	10.000	8.000	7.964
LFM-0810-09	8.0	+0.025 +0.083	10.0	15.0	9.5	1.0	8.083	8.025	10.015	10.000	8.000	7.964
LFM-0810-10	8.0	+0.025 +0.083	10.0	15.0	10.0	1.0	8.083	8.025	10.015	10.000	8.000	7.964
LFM-0810-23	8.0	+0.025 +0.083	10.0	15.0	23.0	1.0	8.083	8.025	10.015	10.000	8.000	7.964
LFM-0810-30	8.0	+0.025 +0.083	10.0	15.0	30.0	1.0	8.083	8.025	10.015	10.000	8.000	7.964
LFM-081015-05	8.0	+0.025 +0.083	10.0	15.0	5.0	1.0	8.083	8.025	10.015	10.000	8.000	7.964
LFM-1012-04	10.0	+0.025 +0.083	12.0	18.0	4.0	1.0	10.083	10.025	12.018	12.000	10.000	9.964
LFM-1012-05	10.0	+0.025 +0.083	12.0	18.0	5.0	1.0	10.083	10.025	12.018	12.000	10.000	9.964
LFM-1012-06	10.0	+0.025 +0.083	12.0	18.0	6.0	1.0	10.083	10.025	12.018	12.000	10.000	9.964
LFM-1012-07	10.0	+0.025 +0.083	12.0	18.0	7.0	1.0	10.083	10.025	12.018	12.000	10.000	9.964
LFM-1012-09	10.0	+0.025 +0.083	12.0	18.0	9.0	1.0	10.083	10.025	12.018	12.000	10.000	9.964
LFM-1012-10	10.0	+0.025 +0.083	12.0	18.0	10.0	1.0	10.083	10.025	12.018	12.000	10.000	9.964
LFM-1012-12	10.0	+0.025 +0.083	12.0	18.0	12.0	1.0	10.083	10.025	12.018	12.000	10.000	9.964
LFM-1012-15	10.0	+0.025 +0.083	12.0	18.0	15.0	1.0	10.083	10.025	12.018	12.000	10.000	9.964
LFM-1012-17	10.0	+0.025 +0.083	12.0	18.0	17.0	1.0	10.083	10.025	12.018	12.000	10.000	9.964
LFM-1214-04	12.0	+0.032 +0.102	14.0	20.0	4.0	1.0	12.102	12.032	14.018	14.000	12.000	11.957
LFM-1214-06	12.0	+0.032 +0.102	14.0	20.0	6.0	1.0	12.102	12.032	14.018	14.000	12.000	11.957
LFM-1214-07	12.0	+0.032 +0.102	14.0	20.0	7.0	1.0	12.102	12.032	14.018	14.000	12.000	11.957
LFM-1214-09	12.0	+0.032 +0.102	14.0	20.0	9.0	1.0	12.102	12.032	14.018	14.000	12.000	11.957
LFM-1214-10	12.0	+0.032 +0.102	14.0	20.0	10.0	1.0	12.102	12.032	14.018	14.000	12.000	11.957
LFM-1214-11	12.0	+0.032 +0.102	14.0	20.0	11.0	1.0	12.102	12.032	14.018	14.000	12.000	11.957
LFM-1214-12	12.0	+0.032 +0.102	14.0	20.0	12.0	1.0	12.102	12.032	14.018	14.000	12.000	11.957
LFM-1214-15	12.0	+0.032 +0.102	14.0	20.0	15.0	1.0	12.102	12.032	14.018	14.000	12.000	11.957

iglide® Plain Bearings L280 - Flange, MM



iglide® L280
Flange - MM

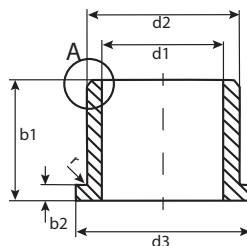
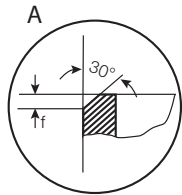

For tolerance values
please refer to page 7.4

$r = \max. 0.5$

Dimensions according to ISO 3547-1 and special dimensions

Part Number	d1 ¹⁾ After Pressfit in Ø H7		d2	d3 d13	b1 h13	b2 -0.14	I.D. After Pressfit		Housing Bore		Shaft Size	
	Max.	Min.					Max.	Min.	Max.	Min.		
LFM-1214-17	12.0	+0.032 +0.102	14.0	20.0	17.0	1.0	12.102	12.032	14.018	14.000	12.000	11.957
LFM-1214-20	12.0	+0.032 +0.102	14.0	20.0	20.0	1.0	12.102	12.032	14.018	14.000	12.000	11.957
LFM-1315-06	13.0	+0.032 +0.102	15.0	22.0	6.0	1.0	13.102	13.032	15.018	15.000	13.000	12.957
LFM-1416-04	14.0	+0.032 +0.102	16.0	22.0	4.0	1.0	14.102	14.032	16.018	16.000	14.000	13.957
LFM-1416-05	14.0	+0.032 +0.102	16.0	22.0	5.0	1.0	14.102	14.032	16.018	16.000	14.000	13.957
LFM-1416-08	14.0	+0.032 +0.102	16.0	22.0	8.0	1.0	14.102	14.032	16.018	16.000	14.000	13.957
LFM-1416-12	14.0	+0.032 +0.102	16.0	22.0	12.0	1.0	14.102	14.032	16.018	16.000	14.000	13.957
LFM-1416-17	14.0	+0.032 +0.102	16.0	22.0	17.0	1.0	14.102	14.032	16.018	16.000	14.000	13.957
LFM-1416-29	14.0	+0.032 +0.102	16.0	22.0	29.0	1.0	14.102	14.032	16.018	16.000	14.000	13.957
LFM-1517-09	15.0	+0.032 +0.102	17.0	23.0	9.0	1.0	15.102	15.022	17.018	17.000	15.000	14.957
LFM-1517-12	15.0	+0.032 +0.102	17.0	23.0	12.0	1.0	15.102	15.022	17.018	17.000	15.000	14.957
LFM-1517-17	15.0	+0.032 +0.102	17.0	23.0	17.0	1.0	15.102	15.022	17.018	17.000	15.000	14.957
LFM-1517-20	15.0	+0.032 +0.102	17.0	23.0	20.0	1.0	15.102	15.022	17.018	17.000	15.000	14.957
LFM-1618-09	16.0	+0.032 +0.102	18.0	24.0	9.0	1.0	16.102	16.032	18.018	18.000	16.000	15.957
LFM-1618-12	16.0	+0.032 +0.102	18.0	24.0	12.0	1.0	16.102	16.032	18.018	18.000	16.000	15.957
LFM-1618-17	16.0	+0.032 +0.102	18.0	24.0	17.0	1.0	16.102	16.032	18.018	18.000	16.000	15.957
LFM-1719-12	17.0	+0.032 +0.102	19.0	25.0	12.0	1.0	17.102	17.032	19.018	19.000	17.000	16.957
LFM-1719-18	17.0	+0.032 +0.102	19.0	25.0	18.0	1.0	17.102	17.032	19.018	19.000	17.000	16.957
LFM-1719-25	17.0	+0.032 +0.102	19.0	25.0	25.0	1.0	17.102	17.032	19.018	19.000	17.000	16.957
LFM-1820-06	18.0	+0.032 +0.102	20.0	26.0	6.0	1.0	18.102	18.032	20.021	20.000	18.000	17.957
LFM-1820-12	18.0	+0.032 +0.102	20.0	26.0	12.0	1.0	18.102	18.032	20.021	20.000	18.000	17.957
LFM-1820-17	18.0	+0.032 +0.102	20.0	26.0	17.0	1.0	18.102	18.032	20.021	20.000	18.000	17.957
LFM-1820-22	18.0	+0.032 +0.102	20.0	26.0	22.0	1.0	18.102	18.032	20.021	20.000	18.000	17.957
LFM-2023-11	20.0	+0.040 +0.124	23.0	23.0	11.0	1.5	20.124	20.040	23.021	23.000	20.000	19.948
LFM-2023-14	20.0	+0.040 +0.124	23.0	30.0	14.0	1.5	20.124	20.040	23.021	23.000	20.000	19.948
LFM-2023-16	20.0	+0.040 +0.124	23.0	30.0	16.0	1.5	20.124	20.040	23.021	23.000	20.000	19.948
LFM-2023-21	20.0	+0.040 +0.124	23.0	30.0	21.0	1.5	20.124	20.040	23.021	23.000	20.000	19.948
LFM-2427-10	24.0	+0.040 +0.124	27.0	32.0	10.0	1.5	24.124	24.040	27.021	27.000	24.000	23.948
LFM-2528-11	25.0	+0.040 +0.124	28.0	35.0	11.0	1.5	25.124	25.040	28.021	28.000	25.000	24.948
LFM-2528-16	25.0	+0.040 +0.124	28.0	35.0	16.0	1.5	25.124	25.040	28.021	28.000	25.000	24.948
LFM-2528-21	25.0	+0.040 +0.124	28.0	35.0	21.0	1.5	25.124	25.040	28.021	28.000	25.000	24.948
LFM-2528-30	25.0	+0.040 +0.124	28.0	35.0	30.0	1.5	25.124	25.040	28.021	28.000	25.000	24.948
LFM-252831-13	25.0	+0.040 +0.124	28.0	31.0	13.0	1.5	25.124	25.040	28.021	28.000	25.000	24.948
LFM-2830-36	28.0	+0.040 +0.124	30.0	35.0	36.0	1.0	28.124	28.040	30.025	30.000	28.000	27.948
LFM-3034-10	30.0	+0.040 +0.124	34.0	42.0	10.0	2.0	30.124	30.040	34.025	34.000	30.000	29.948
LFM-3034-16	30.0	+0.040 +0.124	34.0	42.0	16.0	2.0	30.124	30.040	34.025	34.000	30.000	29.948
LFM-3034-26	30.0	+0.040 +0.124	34.0	42.0	26.0	2.0	30.124	30.040	34.025	34.000	30.000	29.948
LFM-3034-37	30.0	+0.040 +0.124	34.0	42.0	37.0	2.0	30.124	30.040	34.025	34.000	30.000	29.948
LFM-3236-16	32.0	+0.050 +0.150	36.0	40.0	16.0	2.0	32.150	32.050	36.025	36.000	32.000	31.938
LFM-3236-26	32.0	+0.050 +0.150	36.0	40.0	26.0	2.0	32.150	32.050	36.025	36.000	32.000	31.938
LFM-3539-09	35.0	+0.050 +0.150	39.0	47.0	9.0	2.0	35.150	35.050	39.025	39.000	35.000	34.938

PDF: www.igus.com/iglide-pdfs
 CAD: www.igus.com/iglide-CAD
 RoHS info: www.igus.com/RoHS



iglide® L280
Flange - MM

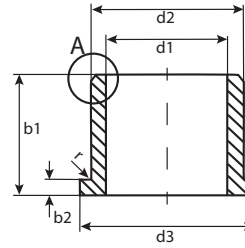
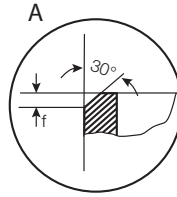

For tolerance values
please refer to page 7.4

r = max. 0.5

Telephone 1-800-521-2747
Fax 1-401-438-7270

Dimensions according to ISO 3547-1 and special dimensions

Part Number	d1 ¹⁾		d2	d3	b1	b2	I.D. After Pressfit		Housing Bore		Shaft Size	
	After Pressfit in Ø H7						Max.	Min.	Max.	Min.	Max.	Min.
LFM-3539-16	35.0	+0.050 +0.150	39.0	47.0	16.0	2.0	35.150	35.050	39.025	39.000	35.000	34.938
LFM-3539-26	35.0	+0.050 +0.150	39.0	47.0	26.0	2.0	35.150	35.050	39.025	39.000	35.000	34.938
LFM-353950-35	35.0	+0.050 +0.150	39.0	50.0	35.0	2.0	35.150	35.050	39.025	39.000	35.000	34.938
LFM-3842-22	38.0	+0.050 +0.150	42.0	50.0	22.0	2.0	38.150	38.050	42.025	42.000	38.000	37.938
LFM-4044-30	40.0	+0.050 +0.150	44.0	52.0	30.0	2.0	40.150	40.050	44.025	44.000	40.000	39.938
LFM-4044-40	40.0	+0.050 +0.150	44.0	52.0	40.0	2.0	40.150	40.050	44.025	44.000	40.000	39.938
LFM-4550-50	45.0	+0.050 +0.150	50.0	58.0	50.0	2.0	45.150	45.050	50.030	50.000	45.000	44.938
LFM-5055-40	50.0	+0.050 +0.150	55.0	63.0	40.0	2.0	50.150	50.050	55.030	55.000	50.000	49.938
LFM-5055-50	50.0	+0.050 +0.150	55.0	63.0	50.0	2.0	50.150	50.050	55.030	55.000	50.000	49.938
LFM-5560-60	55.0	+0.060 +0.180	60.0	68.0	60.0	2.0	55.180	55.060	60.030	60.000	55.000	54.928
LFM-5762-40	57.0	+0.060 +0.180	62.0	67.0	40.0	2.0	57.180	57.060	62.030	62.000	57.000	57.928
LFM-6065-60	60.0	+0.060 +0.180	65.0	73.0	60.0	2.0	60.180	60.060	65.030	65.000	60.000	59.928
LFM-6570-60	65.0	+0.060 +0.180	70.0	78.0	60.0	2.0	65.180	65.060	70.030	70.000	65.000	64.928
LFM-7075-100	70.0	+0.060 +0.180	75.0	83.0	100.0	2.0	70.180	70.060	75.030	75.000	70.000	69.928
LFM-7580-100	75.0	+0.060 +0.180	80.0	88.0	100.0	2.0	75.180	75.060	80.030	80.000	75.000	74.928
LFM-8085-100	80.0	+0.060 +0.180	85.0	93.0	100.0	2.5	80.180	80.060	85.035	85.000	80.000	79.928
LFM-9095-100	90.0	+0.072 +0.212	95.0	103.0	100.0	2.5	90.212	90.072	95.035	95.000	90.000	94.912
LFM-100105-100	100.0	+0.072 +0.212	105.0	113.0	100.0	2.5	100.212	100.072	105.035	105.000	100.000	99.912
LFM-120125-100	120.0	+0.072 +0.212	125.0	133.0	100.0	2.5	120.212	120.072	125.035	125.000	120.000	121.912

Internet: <http://www.igus.com>
 email: sales@igus.com
 QuickSpec: <http://www.igus.com/iglide-quickspec>

iglide® Plain Bearings L280 - Thrust Washer, MM

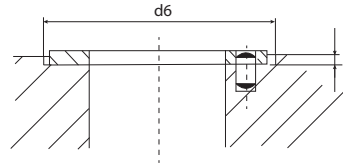
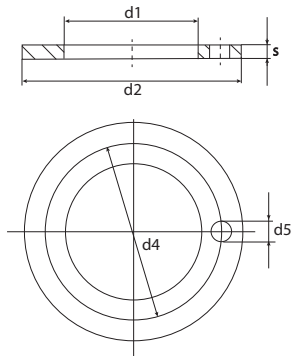

iglide® L280
Thrust Washer - MM

Part Number	d1 +0.25	d2 -0.25	s -0.05	d4 -0.12 +0.12	d5 +0.375 +0.125	h +0.2 -0.2	d6 +0.12
LTM-0509-006	5.0	9.5	0.6	*	*	.3	9.5
LTM-0620-015	6.0	20.0	1.5	13.0	1.5	1.0	20.0
LTM-0818-015	8.0	18.0	1.5	13.0	1.5	1.0	18.0
LTM-1018-010	10.0	18.0	1.0	14.0	1.5	.7	18.0
LTM-1018-015	10.0	18.0	1.5	14.0	1.5	.7	18.0
LTM-1224-015	12.0	24.0	1.5	18.0	1.5	1.0	24.0
LTM-1426-015	14.0	26.0	1.5	20.0	2.0	1.0	26.0
LTM-1524-015	15.0	24.0	1.5	19.5	1.5	1.0	24.0
LTM-1630-015	16.0	30.0	1.5	23.0	2.0	1.0	30.0
LTM-1832-015	18.0	32.0	1.5	25.0	2.0	1.0	32.0
LTM-2036-015	20.0	36.0	1.5	28.0	3.0	1.0	36.0
LTM-2238-015	22.0	38.0	1.5	30.0	3.0	1.0	38.0
LTM-2442-015	24.0	42.0	1.5	33.0	3.0	1.0	42.0
LTM-2644-015	26.0	44.0	1.5	35.0	3.0	1.0	44.0
LTM-2848-015	28.0	48.0	1.5	38.0	4.0	1.0	48.0
LTM-3254-015	32.0	54.0	1.5	43.0	4.0	1.0	54.0
LTM-3862-015	38.0	62.0	1.5	50.0	4.0	1.0	62.0
LTM-4266-015	42.0	66.0	1.5	54.0	4.0	1.0	66.0
LTM-4874-020	48.0	74.0	2.0	61.0	4.0	1.5	74.0
LTM-5278-020	52.0	78.0	2.0	65.0	4.0	1.5	78.0
LTM-6290-020	62.0	90.0	2.0	76.0	4.0	1.5	90.0
LTM-82110-020	82.0	110.0	2.0	*	*	1.5	110.0
LTM-102130-020	102.0	130.0	2.0	*	*	1.5	130.0
LTM-120150-020	120.0	150.0	2.0	*	*	1.5	150.0

* Design without bore

PDF: www.igus.com/iglide-pdfs
 CAD: www.igus.com/iglide-CAD
 RoHS info: www.igus.com/RoHS





iglide® Plain Bearings L280 - Notes

iglide® L280

Telephone 1-800-521-2747
Fax 1-401-438-7270

Internet: <http://www.igus.com>
email: sales@igus.com
QuickSpec: <http://www.igus.com/iglide-quickspec>

igus[®]



iglide[®] Q



Product Range

- Standard Styles:
Sleeve, Flange and Thrust Washer
- Custom shapes and sizes available
- Inner diameters:
Inch sizes from 1/8 - 3 in.
Metric sizes from 6 - 80 mm)

Part Number Structure

Part Number Structure

Q S I-02 03-04

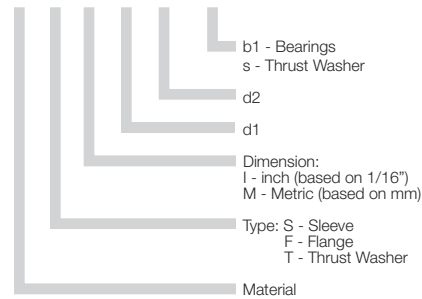

Permissible Surface Speeds

	Continuous fpm	Short Term fpm
Rotating	196	393
Oscillating	137	275
Linear	984	1181

Usage Guidelines



- When there are very high loads
- For shock and impact loads
- For oscillating applications



- When temperatures are continuously greater than 275°F
➤ iglide® T500, Z
- When electrically conductive bearings are needed
➤ iglide® F



Visit www.igus.com
to use our online
expert system

Material Table

General Properties	Unit	iglide® Q	Testing Method
Density	g/cm ³	1.40	
Color		black	
Max. moisture absorption at 73°F / 50% r.h.	% weight	0.9	DIN 53495
Max. moisture absorption	% weight	4.9	
Coefficient of friction, dynamic against steel	μ	0.05 - 0.15	
p x v value, max. (dry)	psi x fpm	16,000	

Mechanical Properties

Modulus of elasticity	psi	652,500	DIN 53457
Tensile strength at 68°F	psi	17,400	DIN 53452
Compressive strength	psi	12,905	
Permissible static surface pressure (68°F)	psi	14,500	
Shore D-hardness		83	DIN 53505

Physical and Thermal Properties

Max., long-term application temperature	°F	275	
Max., short-term application temperature	°F	311	
Min. application temperature	°F	-40	
Thermal conductivity	W/m x K	0.23	ASTM C 177
Coefficient of thermal expansion (at 73°F)	K ⁻¹ x 10 ⁻⁵	5	DIN 53752

Electrical Properties

Specific volume resistance	Ωcm	> 10 ¹⁵	DIN IEC 93
Surface resistance	Ω	> 10 ¹²	DIN 53482

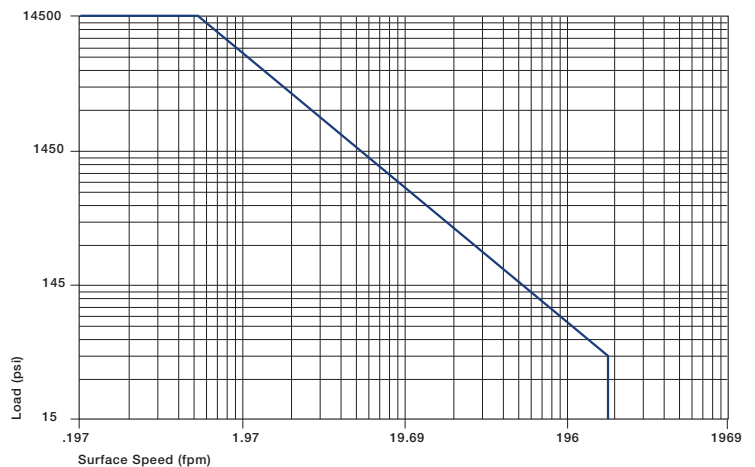

Graph 8.1: Permissible p x v value for iglide® Q running dry against a steel shaft, at 68°F

Igslide® Q plain bearings were developed especially for high load applications. At high loads, iglide® Q ranks among the best iglide® materials for wear resistance. Starting at a radial load of 3625 psi, even plain bearings made of the highly wear-resistant iglide® L280 are outmatched. Special solid lubricants are distributed throughout the iglide® Q material, allowing maintenance-free dry running applications at any load.

Compressive Strength

iglide® Q is a material that is used when high loads over 7250 psi are required. Graph 8.2 shows the elastic deformation of iglide® Q for radial loads. At the maximum permissible static load of 14,500 psi, deformation is less than 3% at room temperature.

► Compressive Strength, Page 1.3

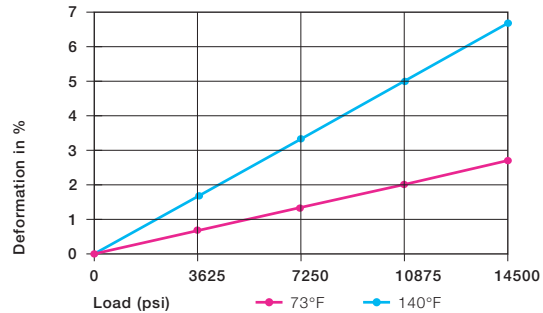

Graph 8.2: Deformation under load and temperature

Permissible Surface Speeds

Under extreme radial loads, iglide® Q plain bearings can achieve the highest $p \times v$ values for plain bearings running dry. Although iglide® Q plain bearings provide the largest advantages, for high loads and low speeds, high surface speeds are also possible, due to excellent friction values. The values in Table 8.2 show the speeds at which friction can cause temperature to increase to maximum permissible levels.

	Continuous fpm	Short Term fpm
Rotating	196	393
Oscillating	137	275
Linear	984	1181

Table 8.2: Maximum surface speeds

► Surface Speed, Page 1.5
► $p \times v$ value, Page 1.6

Temperatures

Plain bearings made of iglide® Q have excellent wear resistance even at high temperatures. The maximum long-term application temperature is 275°F. For the short-term, the material can withstand 311°F. Because of different environmental influences, the bearing can lose pressfit at lower temperatures. Therefore, it may be necessary to secure the bearings in the housing bore. Also, notice that the coefficient of friction increases rapidly as temperature increases beginning at approximately 212°F.

► Application Temperature, Page 1.7

iglide® Q	Application Temperature
Minimum	- 40 °F
Max., long-term	+ 275 °F
Max, short-term	+ 311 °F

Table 8.3: Temperature limits for iglide® Q

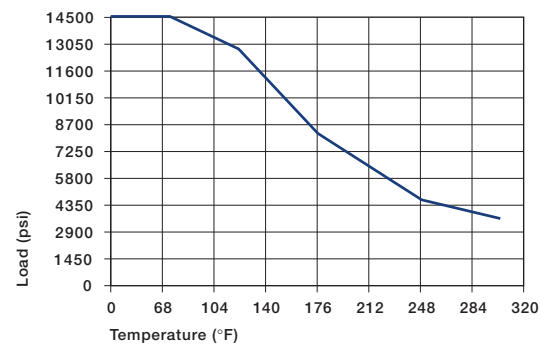

Graph 8.3: Recommended maximum static surface pressure of iglide® Q as a result of the temperature

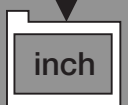
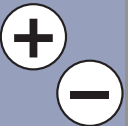



Installation Tolerances

iglide® Q plain bearings are oversized before being pressfit. After proper installation into a recommended housing bore, the inner diameter adjusts to meet our specified tolerances. Please adhere to the catalog specifications for housing bore and recommended shaft sizes. This will help to ensure optimal performance of iglide® plain bearings.

- See Tolerance Table, Page 1.14
- Testing Methods, Page 1.15

For Inch Size Bearings		
Length Tolerance (b1)		Length of Chamfer (f)
Length (inches)	Tolerance (h13) (inches)	Based on d1
0.1181 to 0.2362	-0.0000 /-0.0071	f = .012 → d ₁ .040" - .236"
0.2362 to 0.3937	-0.0000 /-0.0087	f = .019 → d ₁ > .236" - .472"
0.3937 to 0.7086	-0.0000 /-0.0106	f = .031 → d ₁ > .472" - 1.18"
0.7086 to 1.1811	-0.0000 /-0.0130	f = .047 → d ₁ > 1.18"
1.1811 to 1.9685	-0.0000 /-0.0154	
1.9685 to 3.1496	-0.0000 /-0.0181	

For Metric Size Bearings		
Length Tolerance (b1)		Length of Chamfer (f)
Length (mm)	Tolerance (h13) (μm)	Based on d1
1 to 3	-0 /-140	f = 0.3 → d ₁ 1 - 6 mm
>3 to 6	-0 /-180	f = 0.5 → d ₁ > 6 - 12 mm
>6 to 10	-0 /-220	f = 0.8 → d ₁ > 12 - 30 mm
>10 to 18	-0 /-270	f = 1.2 → d ₁ > 30 mm
>18 to 30	-0 /-330	
>30 to 50	-0 /-390	
>50 to 80	-0 /-460	

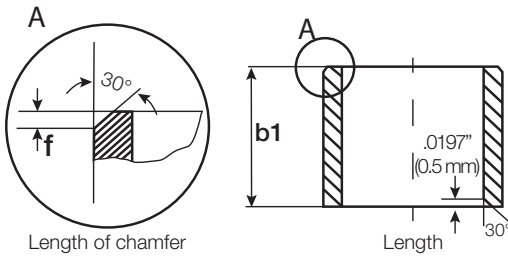

Friction and Wear

Many self-lubricated plain bearings have coefficients of friction that decrease with increasing loads. iglide® Q has the best coefficient of friction of all the iglide® plain bearings. After a short start-up phase, the coefficient of friction drops to its final result. With these low coefficients of friction, iglide® Q is the recommended material, when extreme loads exist and maximum wear resistance is needed. The shafting partner has a large influence on friction and wear. Very smooth shafts increase the friction of the bearing. For applications with high loads, we recommend hardened and ground surfaces with an average roughness range of 6-12 rms.

- Coefficients of Friction and Surfaces, Page 1.8
- Wear Resistance, Page 1.9

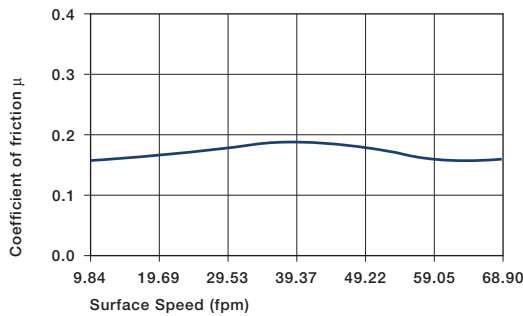

Graph 8.4: Coefficient of friction as a result of the surface speed; load = 108 psi constant

iglide® Q	Coefficient of Friction
Dry	0.05 - 0.15
Grease	0.09
Oil	0.04
Water	0.04

Table 8.4: Coefficient of friction for iglide® Q against steel (Shaft finish = 40 rms, 50 HRC)

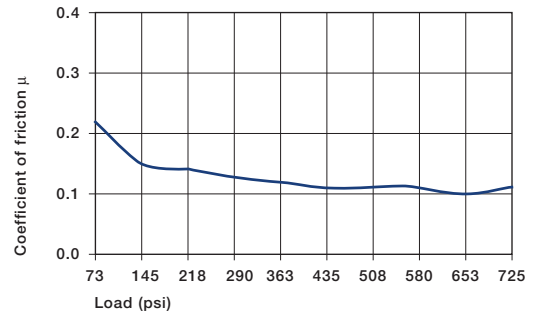

Graph 8.5: Coefficient of friction as a result of the load, v = 1.97 fpm

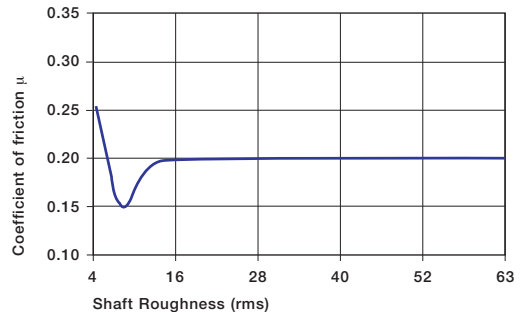

Graph 8.6: Coefficient of friction as a result of the shaft surface

Shaft Materials

Graph 8.7 and 8.8 show results of testing different shaft materials with plain bearings made of iglide® Q.

iglide® Q plain bearings have a higher average wear rate at low loads, than bearings made of iglide® J or L280. However, the strength of iglide® Q is its wear resistance at heavy loads and in oscillating operation. In oscillating movements, iglide® Q plain bearings perform best against hard chromed or machined steel shafts.

If the shaft material you plan to use is not contained in this list, please contact us.

► Shaft Materials, Page 1.11

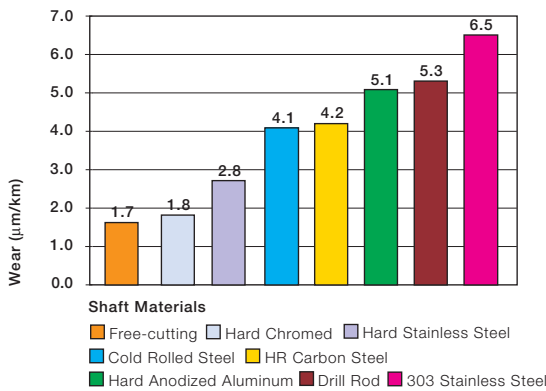

Graph 8.7: Wear of iglide® Q, rotating application with different shaft materials, p=108 psi, v=98 fpm

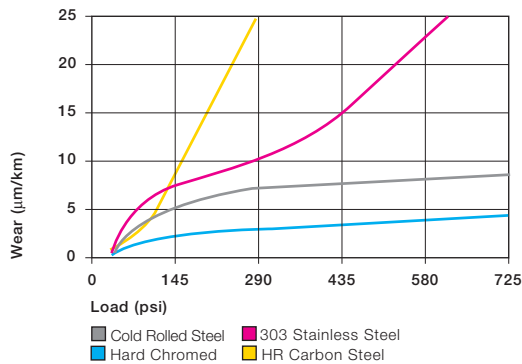

Graph 8.8: Wear with different shaft materials for rotating applications

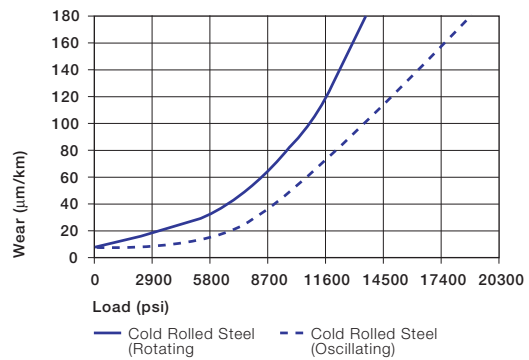

Graph 8.9: Wear for oscillating and rotating applications with a Cold Rolled Steel shaft

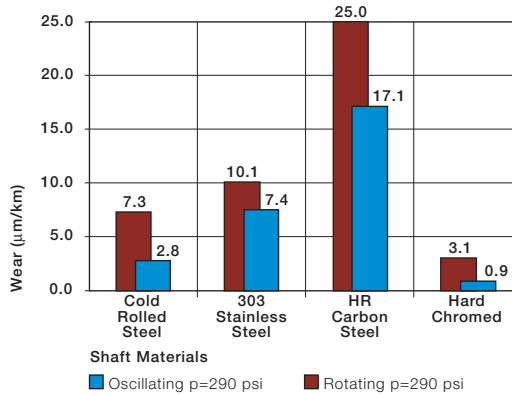

Graph 8.10: Wear for oscillating and rotating applications with different shaft materials at p = 290 psi



Chemical Resistance

iglide® Q plain bearings have excellent chemical resistance. They are resistant to organic solvents, fuels, oils and fats. The material is only partially resistant to weak acids and weak lyes. The moisture absorption of iglide® Q plain bearings is approximately 0.9% in standard atmosphere. The saturation limit in water is 4.9%. This must be taken into account along with any other application conditions.

► Chemicals Table, Page 1.16

Medium	Resistance
Alcohol	+ to 0
Hydrocarbon, chlorinated	+
Greases, oils without additives	+
Fuels	+
Weak acids	0 to -
Strong acids	-
Weak alkaline	+
Strong alkaline	0

+ resistant, 0 conditionally resistant, - not resistant

Table 8.5: Chemical resistance of iglide® Q
All data given concerns the chemical resistance at room temperature (68°F). For a complete list, see page 1.16

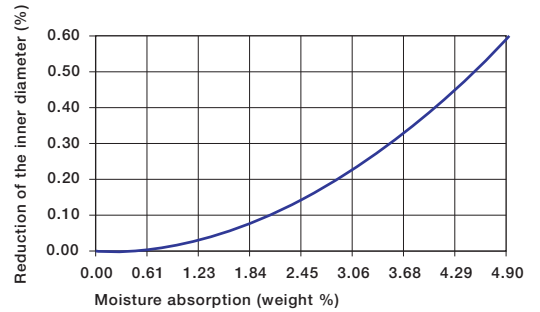

Graph 8.11: Effect of moisture absorption on iglide® Q plain bearings

Radiation Resistance

Plain bearings made from iglide® Q are resistant to radiation up to an intensity of 3×10^2 Gy.

UV-Resistance

The tribological properties of iglide® Q plain bearings stay constant for the most part under weathering effects. However, a slight embrittlement of the material occurs.

Vacuum

When used in a vacuum, the iglide® Q plain bearings release existing moisture as a vapor. Therefore, only dehumidified bearings made of iglide® Q are suitable for the vacuum.

Electrical Properties

iglide® Q plain bearings are electrically insulating.

iglide® Q

Specific volume resistance	< $10^{15} \Omega\text{cm}$
Surface resistance	< $10^{12} \Omega$

Table 8.6: Electrical properties of iglide® Q

iglide® Plain Bearings Q - Sleeve, Inch

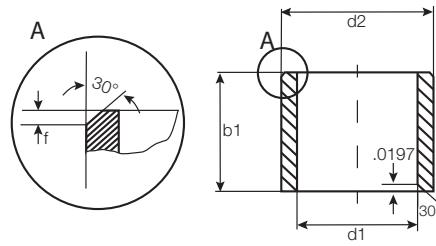

For tolerance values
please refer to page 8.4

iglide® Q
Sleeve - Inch

Part Number	d1	d2	b1	I.D. After Pressfit		Housing Bore		Shaft Size	
				Max.	Min.	Max.	Min.	Max.	Min.
QSI-0203-04	1/8	3/16	1/4	.1269	.1251	.1878	.1873	.1243	.1236
QSI-0304-04	3/16	1/4	1/4	.1892	.1873	.2503	.2497	.1865	.1858
QSI-0304-06	3/16	1/4	3/8	.1892	.1873	.2503	.2497	.1865	.1858
QSI-0405-04	1/4	5/16	1/4	.2521	.2498	.3128	.3122	.2490	.2481
QSI-0405-06	1/4	5/16	3/8	.2521	.2498	.3128	.3122	.2490	.2481
QSI-0405-08	1/4	5/16	1/2	.2521	.2498	.3128	.3122	.2490	.2481
QSI-0506-04	5/16	3/8	1/4	.3148	.3125	.3753	.3747	.3115	.3106
QSI-0506-06	5/16	3/8	3/8	.3148	.3125	.3753	.3747	.3115	.3106
QSI-0506-08	5/16	3/8	1/2	.3148	.3125	.3753	.3747	.3115	.3106
QSI-0607-04	3/8	15/32	1/4	.3773	.3750	.4691	.4684	.3740	.3731
QSI-0607-06	3/8	15/32	3/8	.3773	.3750	.4691	.4684	.3740	.3731
QSI-0607-08	3/8	15/32	1/2	.3773	.3750	.4691	.4684	.3740	.3731
QSI-0708-08	7/16	17/32	1/2	.4406	.4379	.5316	.5309	.4365	.4355
QSI-0809-12	1/2	19/32	3/4	.5030	.5003	.5941	.5934	.4990	.4980
QSI-1011-12	5/8	23/32	3/4	.6280	.6253	.7192	.7184	.6240	.6230
QSI-1214-08	3/4	7/8	1/2	.7541	.7507	.8755	.8747	.7491	.7479
QSI-1214-12	3/4	7/8	3/4	.7541	.7507	.8755	.8747	.7491	.7479
QSI-1214-16	3/4	7/8	1	.7541	.7507	.8755	.8747	.7491	.7479
QSI-1416-16	7/8	1	1	.8791	.8757	1.0005	.9997	.8741	.8729
QSI-1618-16	1	1 1/8	1	1.0041	1.0007	1.1255	1.1247	.9991	.9979
QSI-1618-24	1	1 1/8	1 1/2	1.0041	1.0007	1.1255	1.1247	.9991	.9979
QSI-1820-24	1 1/8	1 9/32	1 1/2	1.1288	1.1254	1.2818	1.2808	1.1238	1.1226
QSI-2022-20	1 1/4	1 13/32	1 1/4	1.2548	1.2508	1.4068	1.4058	1.2488	1.2472
QSI-2022-24	1 1/4	1 13/32	1 1/2	1.2548	1.2508	1.4068	1.4058	1.2488	1.2472
QSI-2426-24	1 1/2	1 21/32	1 1/2	1.5408	1.5008	1.6568	1.6558	1.4988	1.4972
QSI-2629-20	1 5/8	1 25/32	1 1/4	1.6297	1.6258	1.7818	1.7808	1.6238	1.6222
QSI-2831-32	1 3/4	1 15/16	2	1.7547	1.7508	1.9381	1.9371	1.7487	1.7471
QSI-3235-12	2	2 3/16	3/4	2.0057	2.0011	2.1883	2.1871	1.9981	1.9969
QSI-3235-16	2	2 3/16	1	2.0057	2.0011	2.1883	2.1871	1.9981	1.9969
QSI-3235-24	2	2 3/16	1 1/2	2.0057	2.0011	2.1883	2.1871	1.9981	1.9969
QSI-3235-32	2	2 3/16	2	2.0057	2.0011	2.1883	2.1871	1.9981	1.9969
QSI-3235-40	2	2 3/16	2 1/2	2.0057	2.0011	2.1883	2.1871	1.9981	1.9969
QSI-3639-32	2 1/4	2 7/16	2	2.2577	2.2531	2.4377	2.4365	2.2507	2.2489
QSI-4043-16	2 1/2	2 11/16	1.0	2.5082	2.5035	2.6881	2.6869	2.5011	2.4993
QSI-4043-32	2 1/2	2 11/16	2.0	2.5082	2.5035	2.6881	2.6869	2.5011	2.4993
QSI-4851-16	3.0	3 3/16	1.0	3.0070	3.0023	3.1872	3.1858	3.0000	2.9982
QSI-4851-32	3.0	3 3/16	2.0	3.0070	3.0023	3.1872	3.1858	3.0000	2.9982
QSI-4851-48	3.0	3 3/16	3.0	3.0070	3.0023	3.1872	3.1858	3.0000	2.9982

PDF: www.igus.com/iglide-pdfs
CAD: www.igus.com/iglide-CAD
RoHS info: www.igus.com/RoHS





iglide® Plain Bearings Q - Flange, Inch

iglide® Q
Flange - Inch

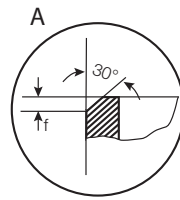

$r = \text{max. } .0197$

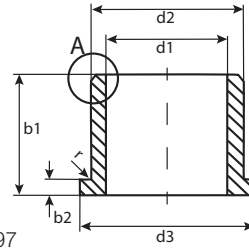

For tolerance values
please refer to page 8.4

Telephone 1-800-521-2747
Fax 1-401-438-7270

Internet: <http://www.igus.com>
email: sales@igus.com
QuickSpec: <http://www.igus.com/iglide-quickspec>

Part Number	d1	d2	b1	d3	b2	I.D. After Pressfit		Housing Bore		Shaft Size	
						Max.	Min.	Max.	Min.	Max.	Min.
QFI-0203-04	1/8	3/16	1/4	.312	.032	.1269	.1251	.1878	.1873	.1243	.1236
QFI-0304-06	3/16	1/4	3/8	.375	.032	.1892	.1873	.2503	.2497	.1865	.1858
QFI-0405-06	1/4	5/16	3/8	.500	.032	.2521	.2498	.3128	.3122	.2490	.2481
QFI-0405-08	1/4	5/16	1/2	.500	.032	.2521	.2498	.3128	.3122	.2490	.2481
QFI-0506-08	5/16	3/8	1/2	.562	.032	.3148	.3125	.3753	.3747	.3115	.3106
QFI-0607-04	3/8	15/32	1/4	.687	.046	.3773	.3750	.4691	.4684	.3740	.3731
QFI-0607-08	3/8	15/32	1/2	.687	.046	.3773	.3750	.4691	.4684	.3740	.3731
QFI-0809-04	1/2	19/32	1/4	.875	.046	.5030	.5003	.5941	.5934	.4990	.4980
QFI-0809-08	1/2	19/32	1/2	.875	.046	.5030	.5003	.5941	.5934	.4990	.4980
QFI-0809-12	1/2	19/32	3/4	.875	.046	.5030	.5003	.5941	.5934	.4990	.4980
QFI-1011-12	5/8	23/32	3/4	.937	.046	.6280	.6253	.7192	.7184	.6240	.6230
QFI-1012-08	5/8	3/4	1/2	1.000	.062	.6290	.6263	.7510	.7500	.6250	.6240
QFI-1214-08	3/4	7/8	1/2	1.125	.062	.7541	.7507	.8755	.8747	.7491	.7479
QFI-1214-12	3/4	7/8	3/4	1.125	.062	.7541	.7507	.8755	.8747	.7491	.7479
QFI-1214-16	3/4	7/8	1	1.125	.062	.7541	.7507	.8755	.8747	.7491	.7479
QFI-1416-12	7/8	1	3/4	1.250	.062	.8791	.8757	1.0005	.9997	.8741	.8729
QFI-1416-16	7/8	1	1	1.250	.062	.8791	.8757	1.0005	.9997	.8741	.8729
QFI-1618-08	1	1 1/8	1/2	1.375	.062	1.0041	1.0007	1.1255	1.1247	.9991	.9979
QFI-1618-16	1	1 1/8	1	1.375	.062	1.0041	1.0007	1.1255	1.1247	.9991	.9979
QFI-1618-24	1	1 1/8	1 1/2	1.375	.062	1.0041	1.0007	1.1255	1.1247	.9991	.9979
QFI-1820-12	1 1/8	1 9/32	3/4	1.562	.078	1.1288	1.1254	1.2818	1.2808	1.1238	1.1226
QFI-1820-24	1 1/8	1 9/32	1 1/2	1.562	.078	1.1288	1.1254	1.2818	1.2808	1.1238	1.1226
QFI-2022-20	1 1/4	1 13/32	1 1/4	1.687	.078	1.2548	1.2508	1.4068	1.4058	1.2488	1.2472
QFI-2022-24	1 1/4	1 13/32	1 1/2	1.687	.078	1.2548	1.2508	1.4068	1.4058	1.2488	1.2472
QFI-2426-04	1 1/2	1 21/32	1/4	2.000	.078	1.5048	1.5008	1.6568	1.6558	1.4988	1.4972
QFI-2426-24	1 1/2	1 21/32	1 1/2	2.000	.078	1.5048	1.5008	1.6568	1.6558	1.4988	1.4972
QFI-2831-32	1 3/4	1 15/16	2	2.375	.093	1.7547	1.7508	1.9381	1.9371	1.7487	1.7471
QFI-3235-32	2	2 3/16	2	2.625	.093	2.0057	2.0011	2.1883	2.1871	1.9981	1.9969
QFI-3639-32	2 1/4	2 7/16	2	2.750	.093	2.2577	2.2531	2.4377	2.4365	2.2507	2.2489

iglide® Plain Bearings Q - Sleeve, MM

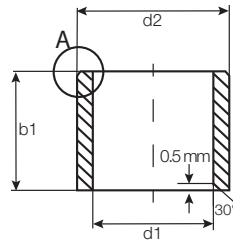
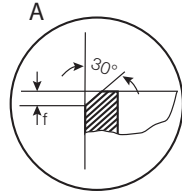

For tolerance values
please refer to page 8.4

Dimensions according to ISO 3547-1 and special dimensions

Part Number	d1	d1-Tolerance After Pressfit in Ø H7	d2	b1 h13	I.D. After Pressfit		Housing Bore		Shaft Size	
					Max.	Min.	Max.	Min.	Max.	Min.
QSM-0608-10	6.0	+0.020 +0.068	8.0	10.0	6.068	6.020	8.015	8.000	6.000	5.970
QSM-0810-08	8.0	+0.025 +0.083	10.0	8.0	8.083	8.025	10.015	10.000	8.000	7.964
QSM-1012-10	10.0	+0.025 +0.083	12.0	10.0	10.083	10.025	12.018	12.000	10.000	9.964
QSM-1214-10	12.0	+0.032 +0.102	14.0	10.0	12.102	12.032	14.018	14.000	12.000	11.957
QSM-1214-20	12.0	+0.032 +0.102	14.0	20.0	12.102	12.032	14.018	14.000	12.000	11.957
QSM-1618-08	16.0	+0.032 +0.102	18.0	8.0	16.102	16.032	18.018	18.000	16.000	15.957
QSM-1618-12	16.0	+0.032 +0.102	18.0	12.0	16.102	16.032	18.018	18.000	16.000	15.957
QSM-1618-20	16.0	+0.032 +0.102	18.0	20.0	16.102	16.032	18.018	18.000	16.000	15.957
QSM-1820-20	18.0	+0.032 +0.102	20.0	20.0	18.102	18.032	20.021	20.000	18.000	17.957
QSM-2022-15	20.0	+0.040 +0.124	22.0	15.0	20.124	20.040	22.021	22.000	20.000	19.948
QSM-2023-15	20.0	+0.040 +0.124	23.0	15.0	20.124	20.040	23.021	23.000	20.000	19.948
QSM-2023-20	20.0	+0.040 +0.124	23.0	20.0	20.124	20.040	23.021	23.000	20.000	19.948
QSM-2023-25	20.0	+0.040 +0.124	23.0	25.0	20.124	20.040	23.021	23.000	20.000	19.948
QSM-2023-30	20.0	+0.040 +0.124	23.0	30.0	20.124	20.040	23.021	23.000	20.000	19.948
QSM-2225-15	22.0	+0.040 +0.124	25.0	15.0	22.124	22.040	25.021	25.000	22.000	21.948
QSM-2528-25	25.0	+0.040 +0.124	28.0	25.0	25.124	25.040	28.021	28.000	25.000	24.948
QSM-2528-48	25.0	+0.040 +0.124	28.0	48.0	25.124	25.040	28.021	28.000	25.000	24.948
QSM-3034-20	30.0	+0.040 +0.124	34.0	20.0	30.124	30.040	34.025	34.000	30.000	29.948
QSM-3034-40	30.0	+0.040 +0.124	34.0	40.0	30.124	30.040	34.025	34.000	30.000	29.948
QSM-3539-15	35.0	+0.050 +0.150	39.0	15.0	35.150	35.050	39.025	39.000	35.000	34.938
QSM-3539-30	35.0	+0.050 +0.150	39.0	30.0	35.150	35.050	39.025	39.000	35.000	34.938
QSM-3539-50	35.0	+0.050 +0.150	39.0	50.0	35.150	35.050	39.025	39.000	35.000	34.938
QSM-4044-40	40.0	+0.050 +0.150	44.0	40.0	40.150	40.050	44.025	44.000	40.000	39.938
QSM-4044-47	40.0	+0.050 +0.150	44.0	47.0	40.150	40.050	44.025	44.000	40.000	39.938
QSM-4550-252	45.0	+0.050 +0.150	50.0	25.2	45.150	45.050	50.025	50.000	45.000	44.938
QSM-4550-50	45.0	+0.050 +0.150	50.0	50.0	45.150	45.050	50.025	50.000	45.000	44.938
QSM-5055-50	50.0	+0.050 +0.150	55.0	50.0	50.150	50.050	55.030	55.000	50.000	49.938
QSM-5055-60	50.0	+0.050 +0.150	55.0	60.0	50.150	50.050	55.030	55.000	50.000	49.938
QSM-5560-50	55.0	+0.050 +0.150	60.0	50.0	55.180	55.060	60.030	60.000	55.000	54.926
QSM-6065-50	60.0	+0.060 +0.180	65.0	50.0	60.180	60.060	65.030	65.000	60.000	59.926
QSM-6570-34	65.0	+0.060 +0.180	70.0	34.0	65.180	65.060	70.030	70.000	65.000	64.926
QSM-7075-50	70.0	+0.060 +0.180	75.0	50.0	70.180	70.060	75.030	75.000	70.000	69.926
QSM-8085-60	80.0	+0.060 +0.180	85.0	60.0	80.180	80.060	85.030	85.000	80.000	79.926

iglide® Q
Sleeve - MM

PDF: www.igus.com/iglide-pdfs
CAD: www.igus.com/iglide-CAD
RoHS info: www.igus.com/RoHS

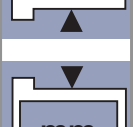
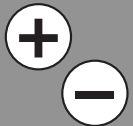



iglide® Q
Flange - MM

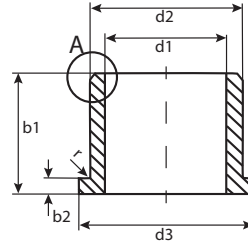
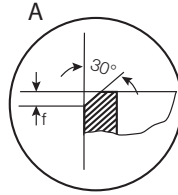

For tolerance values
please refer to page 8.4

r = max. 0.5

Dimensions according to ISO 3547-1 and special dimensions

Part Number	d1 ¹⁾		d2	d3	b1	b2	I.D. After Pressfit		Housing Bore		Shaft Size	
	After Pressfit in Ø H7						Max.	Min.	Max.	Min.	Max.	Min.
QFM-0608-04	6.0	+0.020 +0.068	8.0	12.0	4.0	1.0	6.068	6.020	8.015	8.000	6.000	5.970
QFM-0810-05	8.0	+0.025 +0.083	10.0	15.0	5.5	1.0	8.083	8.025	10.015	10.000	8.000	7.964
QFM-0810-06	8.0	+0.025 +0.083	10.0	15.0	6.0	1.0	8.083	8.025	10.015	10.000	8.000	7.964
QFM-1012-06	10.0	+0.025 +0.083	12.0	18.0	6.0	1.0	10.083	10.025	12.018	12.000	10.000	9.964
QFM-101215-08	10.0	+0.025 +0.083	12.0	15.0	8.0	1.0	10.083	10.025	12.018	12.000	10.000	9.964
QFM-1012-10	10.0	+0.025 +0.083	12.0	18.0	10.0	1.0	10.083	10.025	12.018	12.000	10.000	9.964
QFM-101215-035	10.0	+0.025 +0.083	12.0	15.0	3.5	1.0	10.083	10.025	12.018	12.000	10.000	9.964
QFM-1214-08	12.0	+0.032 +0.102	14.0	20.0	8.0	1.0	12.102	12.032	14.018	14.000	12.000	11.957
QFM-1214-12	12.0	+0.032 +0.102	14.0	20.0	12.0	1.0	12.102	12.032	14.018	14.000	12.000	11.957
QFM-1214-20	12.0	+0.032 +0.102	14.0	20.0	20.0	1.0	12.102	12.032	14.018	14.000	12.000	11.957
QFM-1416-12	14.0	+0.032 +0.102	16.0	22.0	12.0	1.0	14.102	14.032	16.018	16.000	14.000	13.957
QFM-1618-17	16.0	+0.032 +0.102	18.0	24.0	17.0	1.0	16.102	16.032	18.018	18.000	16.000	15.957
QFM-1820-12	18.0	+0.032 +0.102	20.0	26.0	12.0	1.0	18.102	18.032	20.021	20.000	18.000	17.957
QFM-2023-21	20.0	+0.040 +0.124	23.0	30.0	21.0	1.5	20.124	20.040	23.021	23.000	20.000	19.948
QFM-2528-21	25.0	+0.040 +0.124	28.0	35.0	21.5	1.5	25.124	25.040	28.021	28.000	25.000	24.948
QFM-2528-25	25.0	+0.040 +0.124	28.0	35.0	25.0	1.5	25.124	25.040	28.021	28.000	25.000	24.948
QFM-2629-05	26.0	+0.040 +0.124	29.0	35.0	5.0	1.5	26.124	26.040	29.021	29.000	26.000	25.948
QFM-2629-10	26.0	+0.040 +0.124	29.0	35.0	10.0	1.5	26.124	26.040	29.021	29.000	26.000	25.948
QFM-2730-20	27.0	+0.040 +0.124	30.0	38.0	20.0	1.5	27.124	27.040	30.025	30.000	27.000	26.948
QFM-3034-37	30.0	+0.040 +0.124	34.0	42.0	37.0	2.0	30.124	30.040	34.025	34.000	30.000	29.948
QFM-3539-26	35.0	+0.050 +0.150	39.0	47.0	26.0	2.0	35.150	35.050	39.025	39.000	35.000	34.938
QFM-4044-40	40.0	+0.050 +0.150	44.0	52.0	40.0	2.0	40.150	40.050	44.025	44.000	40.000	39.938
QFM-5055-50	50.0	+0.050 +0.150	55.0	63.0	50.0	2.0	50.150	50.050	55.030	55.000	50.000	49.938
QFM-6065-50	60.0	+0.060 +0.180	65.0	73.0	50.0	2.0	60.180	60.060	65.030	65.000	60.000	59.926
QFM-7075-50	70.0	+0.060 +0.180	75.0	83.0	75.0	2.0	70.180	70.060	80.030	80.000	70.000	69.926

Telephone 1-800-521-2747
Fax 1-401-438-7270

Internet: <http://www.igus.com>
email: sales@igus.com
QuickSpec: <http://www.igus.com/iglide-quickspec>

iglide® Plain Bearings
Q - Thrust Washer, MM

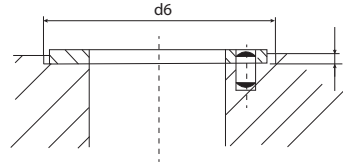
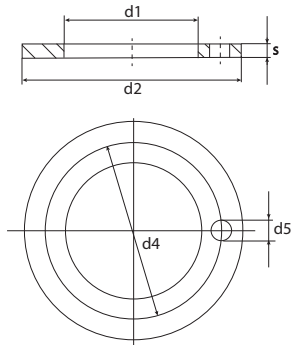

Dimensions according to ISO 3547-1 and special dimensions

Part Number	d1 +0.25	d2 -0.25	s -0.05	d4 -0.12 +0.12	d5 +0.375 +0.125	h +0.2 -0.2	d6 +0.12
QTM-2842-015	28.0	42.0	1.5	35.0	4.0	1.0	42.0
QTM-3254-015	32.0	54.0	1.5	43.0	4.0	1.0	54.0
QTM-3862-015	38.0	62.0	1.5	50.0	4.0	1.0	62.0
QTM-5278-020	52.0	78.0	2.0	65.0	4.0	1.5	78.0

iglide® Q
Thrust Washer - MM

PDF: www.igus.com/iglide-pdfs
CAD: www.igus.com/iglide-CAD
RoHS info: www.igus.com/RoHS

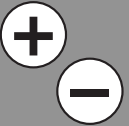



iglide® Plain Bearings
Q - Notes

iglide® Q

Telephone 1-800-521-2747
Fax 1-401-438-7270

Internet: <http://www.igus.com>
email: sales@igus.com
QuickSpec: <http://www.igus.com/iglide-quickspec>

igus[®]



iglide[®] P



Product Range

- Standard Styles:
Sleeve, Flange and Thrust Washer
- Custom shapes and sizes available
- Inner diameters:
Inch sizes from 1/4 - 2 in.
Metric sizes from 3 - 95 mm)

Part Number Structure

Part Number Structure

P S I-04 05-04

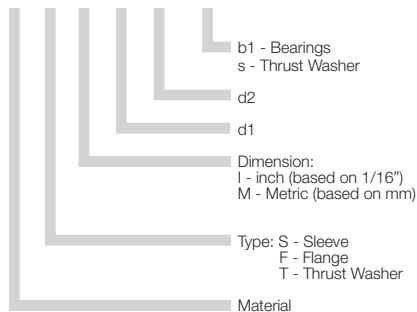

Permissible Surface Speeds

	Continuous fpm	Short Term fpm
Rotating	196	393
Oscillating	137	275
Linear	590	787

Usage Guidelines



- When very low water absorption is needed
- When a cost-effective bearing for high pressure loads is desired
- For rotating movements under high loads



- When the maximum application temperature is above 266°F
➤ iglide® G300
- When mechanical reaming of the wall surface is necessary
➤ iglide® M250
- When the highest wear resistance is needed
➤ iglide® L280



Visit www.igus.com
to use our online
expert system

Material Data

General Properties	Unit	iglide® P	Testing Method
Density	g/cm ³	1.58	
Color		black	
Max. moisture absorption at 73°F / 50% r.h.	% weight	< 0,2	DIN 53495
Max. water absorption	% weight	0.4	
Coefficient of friction, dynamic against steel	μ	0.06 - 0.21	
p x v value, max. (dry)	psi x fpm	11,000	

Mechanical Properties

Modulus of elasticity	psi	768,500	DIN 53457
Tensile strength at 68°F	psi	17,400	DIN 53452
Compressive strength	psi	9,570	
Permissible static surface pressure (68°F)	psi	7,250	
Shore D-hardness		75	DIN 53505

Physical and Thermal Properties

Max. long-term application temperature	°F	266	
Max. short-term application temperature	°F	392	
Min. application temperature	°F	-40	
Thermal conductivity	W/m x K	0.25	ASTM C 177
Coefficient of thermal expansion	K ⁻¹ x 10 ⁻⁵	4	DIN 53752

Electrical Properties

Specific volume resistance	Ωcm	> 10 ¹³	DIN IEC 93
Surface resistance	Ω	> 10 ¹²	DIN 53482

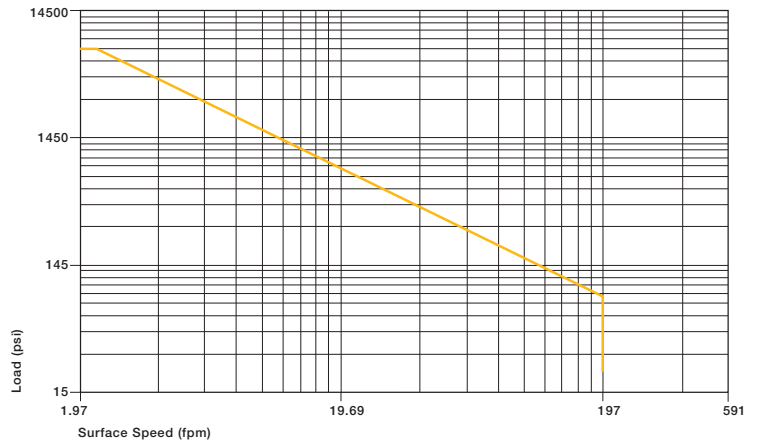

Graph 9.1: Permissible p x v value for iglide® P running dry against a steel shaft, at 68°F

With the iglide® P plain bearing, the user has a cost-effective, maintenance-free plain bearing. Compared to iglide® G300, plain bearings made of iglide® P are better suited for rotating movements and high loads.

Compressive Strength

Graph 9.2 shows the elastic deformation of iglide® P for radial loads. At the maximum permissible load of 5075 psi, the deformation is less than 3% at room temperature.

➤ Compressive Strength, Page 1.3

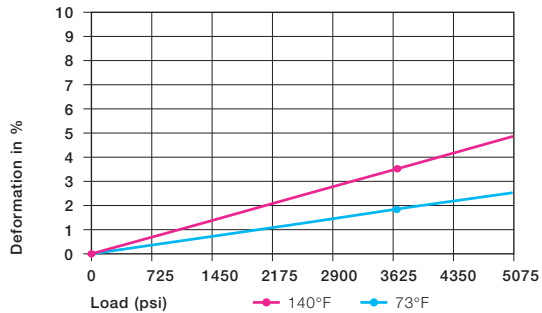

Graph 9.2: Deformation under load and temperature

Permissible Surface Speeds

Plain bearings made from iglide® P are maintenance-free plain bearings, which were developed for low to average surface speeds. The maximum values given in Table 9.2 can only be achieved at a very low surface pressure. The maximum speed given is the speed at which an increase up to the continuous use temperature occurs due to friction.

➤ Surface Speed, Page 1.5
 ➤ $p \times v$ value, Page 1.6

	Continuous fpm	Short Term fpm
Rotating	196	393
Oscillating	137	275
Linear	590	787

Table 9.2: Maximum surface speed

Temperatures

Even at its highest long-term application temperature of 266°F, iglide® P does not quite reach the values of iglide® G300. With a maximum permissible short-term temperature of 392°F, a heat treating process is possible, without additional loading.

With increasing temperatures, the compressive strength of iglide® P plain bearings decreases. Graph 9.3 shows this relationship.

The ambient temperatures in the bearing system also have an effect on the bearing wear. With increasing temperatures, the wear increases.

➤ Application Temperatures, Page 1.7

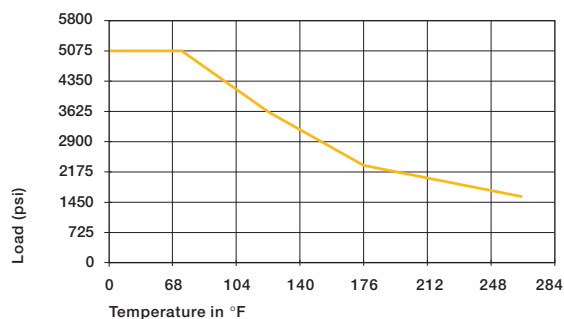

Graph 9.3: Recommended maximum permissible static surface pressure of iglide® P as a result of the temperature

iglide® P	Application Temperature
Minimum	- 40°F
Max., long-term	+ 266°F
Max., short-term	+ 392°F

Table 9.3: Temperature limits for iglide® P

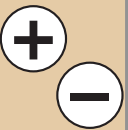



iglide® Plain Bearings P - Technical Data

iglide® P

Telephone 1-800-521-2747
Fax 1-401-438-7270

Internet: <http://www.igus.com>
email: sales@igus.com
QuickSpec: <http://www.igus.com/iglide-quickspec>

Installation Tolerances

iglide® P plain bearings are oversized before being pressfit. After proper installation into a recommended housing bore, the inner diameter adjusts to meet our specified tolerances. Please adhere to the catalog specifications for housing bore and recommended shaft sizes. This will help to ensure optimal performance of iglide® plain bearings.

- See Tolerance Table, Page 1.14
- Testing Methods, Page 1.15

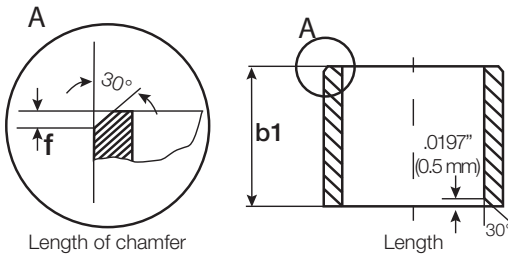

For Inch Size Bearings		
Length Tolerance (b1)	Length of Chamfer (f)	
Length (inches)	Tolerance (h13) (inches)	Based on d1
0.1181 to 0.2362	-0.0000 /-0.0071	f = .012 → d ₁ .040" - .236"
0.2362 to 0.3937	-0.0000 /-0.0087	f = .019 → d ₁ > .236" - .472"
0.3937 to 0.7086	-0.0000 /-0.0106	f = .031 → d ₁ > .472" - 1.18"
0.7086 to 1.1811	-0.0000 /-0.0130	f = .047 → d ₁ > 1.18"
1.1811 to 1.9685	-0.0000 /-0.0154	
1.9685 to 3.1496	-0.0000 /-0.0181	

For Metric Size Bearings		
Length Tolerance (b1)	Length of Chamfer (f)	
Length (mm)	Tolerance (h13) (µm)	Based on d1
1 to 3	-0 /-140	f = 0.3 → d ₁ 1 - 6 mm
> 3 to 6	-0 /-180	f = 0.5 → d ₁ > 6 - 12 mm
> 6 to 10	-0 /-220	f = 0.8 → d ₁ > 12 - 30 mm
> 10 to 18	-0 /-270	f = 1.2 → d ₁ > 30 mm
> 18 to 30	-0 /-330	
> 30 to 50	-0 /-390	
> 50 to 80	-0 /-460	

Friction and Wear

Similar to wear resistance, the coefficient of friction changes greatly with increasing load. For iglide® P the coefficient of friction increases slightly when the speed increases. Picture 9.5 shows how the coefficient of friction drops when the load increases. Starting at approximately 870 psi, the coefficient of friction is already below 0.1.

For iglide® P a ground surface with an average roughness range of 4-8 rms is recommended for the shaft. Both smoother and rougher shaft finishes cause the friction to clearly increase.

- Coefficients of Friction and Surfaces, Page 1.8
- Wear Resistance, Page 1.9

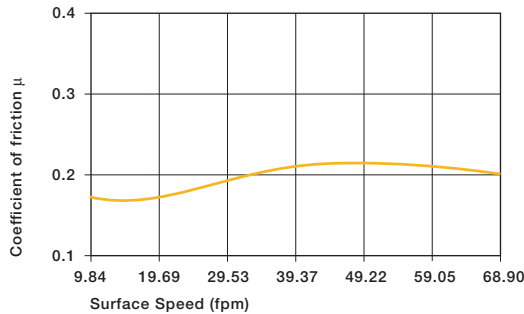

Graph 9.4: Coefficients of friction of iglide® P as a result of the surface speed; p = 108 psi

iglide® P	Coefficient of Friction
Dry	0.09 - 0.21
Grease	0.09
Oil	0.04
Water	0.04

Table 9.4: Coefficients of friction for iglide® P against steel (Shaft finish = 40 rms, 50 HRC)

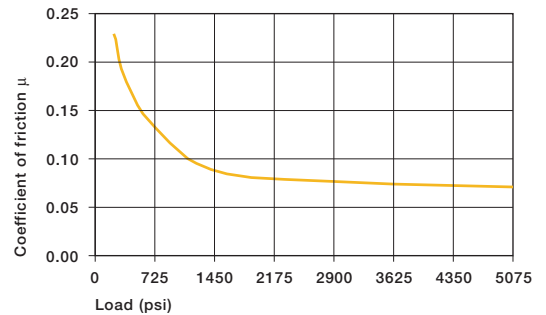

Graph 9.5: Coefficients of friction of iglide® P as a result of the load, v = 1.97 fpm

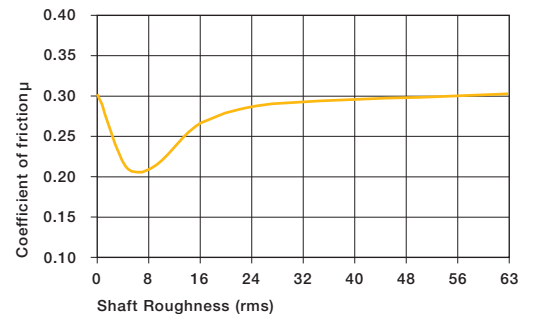

Graph 9.6: Coefficients of friction of iglide® P as a result of the shaft surface (shaft Cold Rolled Steel)

Shaft Materials

Graph 9.7 to 9.10 show results of testing different shaft materials with plain bearings made of iglide® P. For rotating movements, the wear of iglide® P with Cold Rolled Steel and HR Carbon Steel shafts is very low. On the other hand, the bearings on 303 Stainless Steel shafts as well as hard-chromed shafts result in higher wear than other shaft materials even in the low load range. For example at a load of 290 psi, Cold Rolled Steel is six times better than 303 Stainless Steel. For oscillating movements without loads, wear rates are lower than for most rotating movements. For this purpose, the Cold Rolled Steel and hard-chromed shafts prove to be the best sliding partners. Also, the 303 Stainless Steel shafts that have poor results for rotation, are very good in oscillating operation. If the shaft material you plan to use is not contained in this list, please contact us.

➤ Shaft Materials, Page 1.11

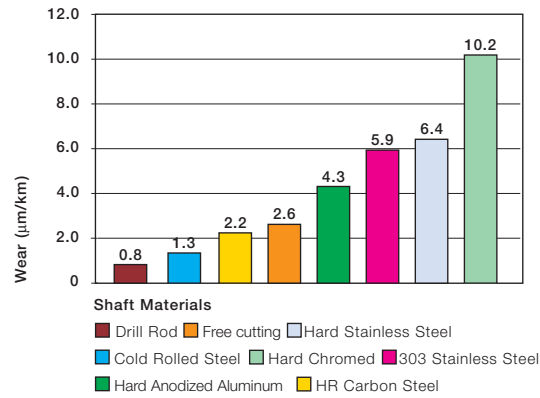

Graph 9.7: Wear of iglide® P with different shaft materials in rotating applications, p=108 psi, v=98 fpm

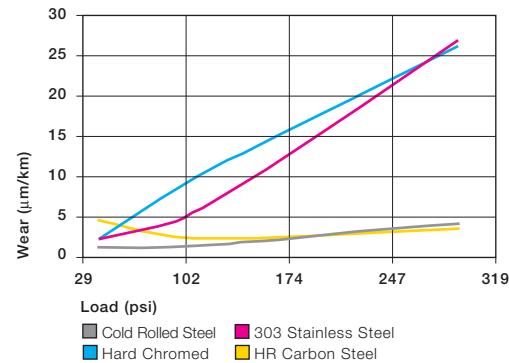

Graph 9.8: Wear of iglide® P with different shaft materials in rotating applications

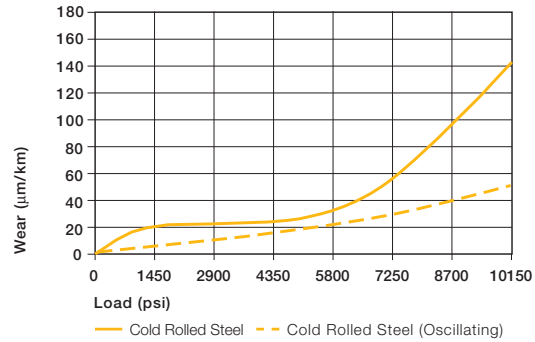

Graph 9.9: Wear with the Cold Rolled Steel shaft in oscillating and rotating applications

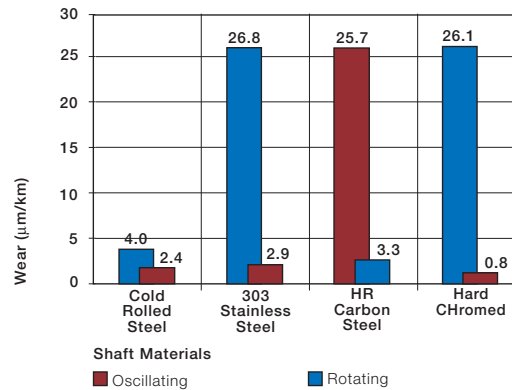

Graph 9.10: Wear with different shaft materials in oscillating and rotating applications p = 290 psi

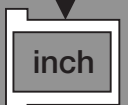
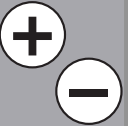



iglide® P

Telephone 1-800-521-2747
Fax 1-401-438-7270

Internet: <http://www.igus.com>
email: sales@igus.com
QuickSpec: <http://www.igus.com/iglide-quickspec>

Chemical Resistance

iglide® P plain bearings are resistant to most chemicals. They are resistant to most lubricants. iglide® P is not attacked by most weak organic and inorganic acids.

The moisture absorption of iglide® P plain bearings is approximately 0.2% in standard atmosphere. The saturation limit in water is 0.4%. This low moisture absorption is clearly below the values of iglide® G300.

➤ Chemical Table, Page 1.16

Medium	Resistance
Alcohol	+
Hydrocarbon, chlorinated	-
Greases, oils without additives	+
Fuels	+
Weak acids	0
Strong acids	-
Weak alkaline	-
Strong alkaline	-

+ resistant, 0 conditionally resistant, - not resistant

Table 9.5: Chemical resistance of iglide® P

All data given concerns the chemical resistance at room temperature (68°F). For a complete list, see page 1.16

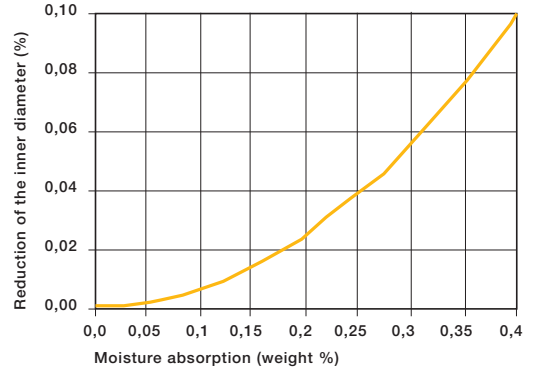

Graph 9.11: Effect of moisture absorption on iglide® P plain bearings

Radiation Resistance

Plain bearings made of iglide® P have limited use under radioactive radiation. They are resistant to radiation up to an intensity of 5×10^2 Gy.

UV-Resistance

iglide® P plain bearings are partially UV resistance.

Vacuum

In a vacuum environment, existing moisture of iglide® P plain bearings is released as a vapor. Use in a vacuum is only possible in a limited manner.

Electrical Properties

iglide® P plain bearings are electrically insulating.

iglide® P

Specific volume resistance	$> 10^{13} \Omega\text{cm}$
Surface resistance	$> 10^{12} \Omega$

Table 9.6: Electrical properties of iglide® P

iglide® Plain Bearings

P - Sleeve, Inch



iglide® P
Sleeve - Inch

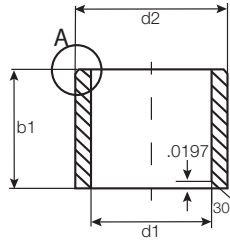
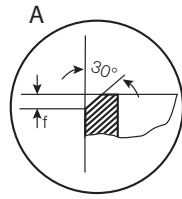

For tolerance values
please refer to page 9.4

Part Number	d1	d2	b1	I.D. After Pressfit		Housing Bore		Shaft Size	
				Max.	Min.	Max.	Min.	Max.	Min.
PSI-0405-04	1/4	5/16	1/4	.2521	.2498	.3128	.3122	.2490	.2481
PSI-0405-06	1/4	5/16	3/8	.2521	.2498	.3128	.3122	.2490	.2481
PSI-0405-08	1/4	5/16	1/2	.2521	.2498	.3128	.3122	.2490	.2481
PSI-0405-12	1/4	5/16	3/4	.2521	.2498	.3128	.3122	.2490	.2481
PSI-0506-04	5/16	3/8	1/4	.3148	.3125	.3753	.3747	.3115	.3106
PSI-0506-06	5/16	3/8	3/8	.3148	.3125	.3753	.3747	.3115	.3106
PSI-0506-08	5/16	3/8	1/2	.3148	.3125	.3753	.3747	.3115	.3106
PSI-0506-12	5/16	3/8	3/4	.3148	.3125	.3753	.3747	.3115	.3106
PSI-0607-04	3/8	15/32	1/4	.3773	.3750	.4691	.4684	.3740	.3731
PSI-0607-06	3/8	15/32	3/8	.3773	.3750	.4691	.4684	.3740	.3731
PSI-0607-08	3/8	15/32	1/2	.3773	.3750	.4691	.4684	.3740	.3731
PSI-0607-12	3/8	15/32	3/4	.3773	.3750	.4691	.4684	.3740	.3731
PSI-0608-08	3/8	1/2	1/2	.3783	.3760	.5015	.5010	.3750	.3741
PSI-0809-06	1/2	19/32	3/8	.5030	.5003	.5941	.5934	.4990	.4980
PSI-0809-08	1/2	19/32	1/2	.5030	.5003	.5941	.5934	.4990	.4980
PSI-0809-10	1/2	19/32	5/8	.5030	.5003	.5941	.5934	.4990	.4980
PSI-0809-12	1/2	19/32	3/4	.5030	.5003	.5941	.5934	.4990	.4980
PSI-0809-16	1/2	19/32	1	.5030	.5003	.5941	.5934	.4990	.4980
PSI-1011-08	5/8	23/32	1/2	.6280	.6253	.7192	.7184	.6240	.6230
PSI-1011-10	5/8	23/32	5/8	.6280	.6253	.7192	.7184	.6240	.6230
PSI-1011-12	5/8	23/32	3/4	.6280	.6253	.7192	.7184	.6240	.6230
PSI-1011-16	5/8	23/32	1	.6280	.6253	.7192	.7184	.6240	.6230
PSI-1214-08	3/4	7/8	1/2	.7541	.7507	.8755	.8747	.7491	.7479
PSI-1214-12	3/4	7/8	3/4	.7541	.7507	.8755	.8747	.7491	.7479
PSI-1214-16	3/4	7/8	1	.7541	.7507	.8755	.8747	.7491	.7479
PSI-1416-08	7/8	1	1/2	.8791	.8757	1.0050	.9997	.8741	.8729
PSI-1416-12	7/8	1	3/4	.8791	.8757	1.0050	.9997	.8741	.8729
PSI-1416-16	7/8	1	1	.8791	.8757	1.0050	.9997	.8741	.8729
PSI-1618-08	1	1 1/8	1/2	1.0041	1.0007	1.1255	1.1247	.9991	.9979
PSI-1618-12	1	1 1/8	3/4	1.0041	1.0007	1.1255	1.1247	.9991	.9979
PSI-1618-16	1	1 1/8	1	1.0041	1.0007	1.1255	1.1247	.9991	.9979
PSI-1618-24	1	1 1/8	1 1/2	1.0041	1.0007	1.1255	1.1247	.9991	.9979
PSI-2022-20	1 1/4	1 13/32	1	1.2548	1.2508	1.4068	1.4058	1.2488	1.2472
PSI-2022-24	1 1/4	1 13/32	1 1/2	1.2548	1.2508	1.4068	1.4058	1.2488	1.2472
PSI-2224-20	1 3/8	1 17/32	1 1/4	1.3798	1.3758	1.5318	1.5308	1.3738	1.3722
PSI-2224-24	1 3/8	1 17/32	1 1/2	1.3798	1.3758	1.5318	1.5308	1.3738	1.3722
PSI-2426-20	1 1/2	1 21/32	1 1/4	1.5048	1.5008	1.6568	1.6558	1.4988	1.4972
PSI-2426-24	1 1/2	1 21/32	1 1/2	1.5048	1.5008	1.6568	1.6558	1.4988	1.4972
PSI-3235-32	2	2 3/16	2	2.0052	2.0011	2.1883	2.1871	1.9981	1.9969

PDF: www.igus.com/iglide-pdfs
 CAD: www.igus.com/iglide-CAD
 RoHS info: www.igus.com/RoHS





iglide® Plain Bearings P - Flange, Inch

iglide® P
Flange - Inch

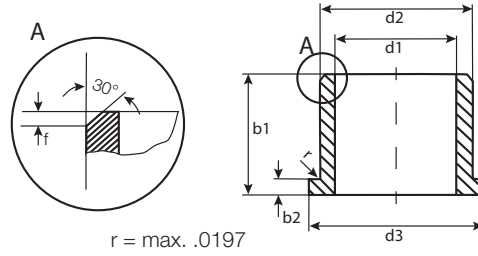

For tolerance values
please refer to page 9.4

Telephone 1-800-521-2747
Fax 1-401-438-7270

Internet: <http://www.igus.com>
email: sales@igus.com
QuickSpec: <http://www.igus.com/iglide-quickspec>

Part Number	d1	d2	b1	d3	b2 -.0055	I.D. After Pressfit		Housing Bore		Shaft Size	
						Max.	Min.	Max.	Min.	Max.	Min.
PFI-0405-04	1/4	5/16	1/4	.500	.032	.2521	.2498	.3128	.3122	.2490	.2481
PFI-0405-05	1/4	5/16	5/16	.500	.032	.2521	.2498	.3128	.3122	.2490	.2481
PFI-0405-06	1/4	5/16	3/8	.500	.032	.2521	.2498	.3128	.3122	.2490	.2481
PFI-0405-08	1/4	5/16	1/2	.500	.032	.2521	.2498	.3128	.3122	.2490	.2481
PFI-0405-12	1/4	5/16	3/4	.500	.032	.2521	.2498	.3128	.3122	.2490	.2481
PFI-0506-04	5/16	3/8	1/4	.562	.032	.3148	.3125	.3753	.3747	.3115	.3106
PFI-0506-06	5/16	3/8	3/8	.562	.032	.3148	.3125	.3753	.3747	.3115	.3106
PFI-0506-08	5/16	3/8	1/2	.562	.032	.3148	.3125	.3753	.3747	.3115	.3106
PFI-0506-12	5/16	3/8	3/4	.562	.032	.3148	.3125	.3753	.3747	.3115	.3106
PFI-0607-04	3/8	15/32	1/4	.687	.046	.3773	.3750	.4691	.4684	.3740	.3731
PFI-0607-06	3/8	15/32	3/8	.687	.046	.3773	.3750	.4691	.4684	.3740	.3731
PFI-0607-08	3/8	15/32	1/2	.687	.046	.3773	.3750	.4691	.4684	.3740	.3731
PFI-0607-12	3/8	15/32	3/4	.687	.046	.3773	.3750	.4691	.4684	.3740	.3731
PFI-0809-06	1/2	19/32	3/8	.875	.046	.5030	.5003	.5941	.5934	.4990	.4980
PFI-0809-08	1/2	19/32	1/2	.875	.046	.5030	.5003	.5941	.5934	.4990	.4980
PFI-0809-10	1/2	19/32	5/8	.875	.046	.5030	.5003	.5941	.5934	.4990	.4980
PFI-0809-12	1/2	19/32	3/4	.875	.046	.5030	.5003	.5941	.5934	.4990	.4980
PFI-0809-16	1/2	19/32	1	.875	.046	.5030	.5003	.5941	.5934	.4990	.4980
PFI-0810-10	1/2	5/8	5/8	.875	.062	.5040	.5013	.6257	.6250	.5000	.4983
PFI-1011-06	5/8	23/32	3/8	.937	.046	.6280	.6253	.7192	.7184	.6240	.6230
PFI-1011-08	5/8	23/32	1/2	.937	.046	.6280	.6253	.7192	.7184	.6240	.6230
PFI-1011-12	5/8	23/32	3/4	.937	.046	.6280	.6253	.7192	.7184	.6240	.6230
PFI-1011-16	5/8	23/32	1	.937	.046	.6280	.6253	.7192	.7184	.6240	.6230
PFI-1214-08	3/4	7/8	1/2	1.125	.062	.7541	.7507	.8755	.8747	.7491	.7479
PFI-1214-12	3/4	7/8	3/4	1.125	.062	.7541	.7507	.8755	.8747	.7491	.7479
PFI-1214-16	3/4	7/8	1	1.125	.062	.7541	.7507	.8755	.8747	.7491	.7479
PFI-1416-08	7/8	1	1/2	1.250	.062	.8791	.8757	1.0005	.9997	.8741	.8729
PFI-1416-12	7/8	1	3/4	1.250	.062	.8791	.8757	1.0005	.9997	.8741	.8729
PFI-1416-16	7/8	1	1	1.250	.062	.8791	.8757	1.0005	.9997	.8741	.8729
PFI-1618-08	1	1 1/8	1/2	1.375	.062	1.0041	1.0007	1.1255	1.1247	.9991	.9979
PFI-1618-12	1	1 1/8	3/4	1.375	.062	1.0041	1.0007	1.1255	1.1247	.9991	.9979
PFI-1618-16	1	1 1/8	1	1.375	.062	1.0041	1.0007	1.1255	1.1247	.9991	.9979
PFI-1618-24	1	1 1/8	1 1/2	1.375	.062	1.0041	1.0007	1.1255	1.1247	.9991	.9979
PFI-2224-16	1 3/8	1 1/2	1	1.875	.078	1.3798	1.3758	1.5318	1.5308	1.3738	1.3722
PFI-2426-20	1 1/2	1 21/32	1 1/4	2.000	.078	1.5408	1.5008	1.6568	1.6558	1.4988	1.4972
PFI-2426-24	1 1/2	1 21/32	1 1/2	2.000	.078	1.5408	1.5008	1.6568	1.6558	1.4988	1.4972

iglide® Plain Bearings P - Sleeve, MM



iglide® P
Sleeve - MM

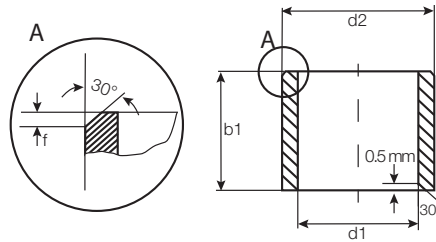

For tolerance values
please refer to page 9.4

Dimensions according to ISO 3547-1 and special dimensions

Part Number	d1		d2	b1 h13	I.D. After Pressfit		Housing Bore		Shaft Size	
	After Pressfit in Ø H7				Max.	Min.	Max.	Min.	Max.	Min.
PSM-0304-03	3.0	+0.014 +0.054	4.5	3.0	3.054	3.014	4.512	4.500	3.000	2.975
PSM-0405-04	4.0	+0.020 +0.068	5.5	4.0	4.068	4.020	5.512	5.500	4.000	3.970
PSM-0507-05	5.0	+0.010 +0.040	7.0	5.0	5.040	5.010	7.015	7.000	5.000	4.970
PSM-0608-06	6.0	+0.020 +0.068	8.0	6.0	6.068	6.020	8.015	8.000	6.000	5.970
PSM-0810-08	8.0	+0.025 +0.083	10.0	8.0	8.083	8.025	10.015	10.000	8.000	7.964
PSM-0810-11	8.0	+0.025 +0.083	10.0	11.0	8.083	8.025	10.015	10.000	8.000	7.964
PSM-0810-12	8.0	+0.025 +0.083	10.0	12.0	8.083	8.025	10.015	10.000	8.000	7.964
PSM-1012-10	10.0	+0.025 +0.083	12.0	10.0	10.083	10.025	12.018	12.000	10.000	9.964
PSM-1214-15	12.0	+0.032 +0.102	14.0	15.0	12.102	12.032	14.018	14.000	12.000	11.957
PSM-1214-25	12.0	+0.032 +0.102	14.0	25.0	12.102	12.032	14.018	14.000	12.000	11.957
PSM-1517-15	15.0	+0.032 +0.102	17.0	15.0	15.102	15.032	17.018	17.000	15.000	14.957
PSM-1618-20	16.0	+0.032 +0.102	18.0	20.0	16.102	16.032	18.018	18.000	16.000	15.957
PSM-1618-42	16.0	+0.032 +0.102	18.0	42.0	16.102	16.032	18.018	18.000	16.000	15.957
PSM-1820-15	18.0	+0.032 +0.102	20.0	15.0	18.102	18.032	20.021	20.000	18.000	17.957
PSM-2022-22	20.0	+0.040 +0.124	22.0	22.0	20.124	20.040	22.021	22.000	20.000	19.948
PSM-2022-30	20.0	+0.040 +0.124	22.0	30.0	20.124	20.040	22.021	22.000	20.000	19.948
PSM-2022-51	20.0	+0.040 +0.124	22.0	51.0	20.124	20.040	22.021	22.000	20.000	19.948
PSM-2023-15	20.0	+0.040 +0.124	23.0	15.0	20.124	20.040	23.021	23.000	20.000	19.948
PSM-2023-20	20.0	+0.040 +0.124	23.0	20.0	20.124	20.040	23.021	23.000	20.000	19.948
PSM-2023-30	20.0	+0.040 +0.124	23.0	30.0	20.124	20.040	23.021	23.000	20.000	19.948
PSM-2224-45	22.0	+0.040 +0.124	24.0	45.0	22.124	22.040	24.021	24.000	22.000	21.948
PSM-2225-15	22.0	+0.040 +0.124	25.0	15.0	22.124	22.040	25.021	25.000	22.000	21.948
PSM-2225-45	22.0	+0.040 +0.124	25.0	45.0	22.124	22.040	25.021	25.000	22.000	21.948
PSM-2325-37	23.0	+0.040 +0.124	25.0	37.0	23.124	23.040	25.021	25.000	23.000	22.948
PSM-2528-30	25.0	+0.040 +0.124	28.0	30.0	25.124	25.040	28.021	28.000	25.000	24.948
PSM-2528-35	25.0	+0.040 +0.124	28.0	35.0	25.124	25.040	28.021	28.000	25.000	24.948
PSM-2630-25	26.0	+0.040 +0.124	30.0	25.0	26.124	26.040	30.021	30.000	26.000	25.948
PSM-2832-20	28.0	+0.040 +0.124	32.0	20.0	28.124	28.040	32.025	32.000	28.000	27.948
PSM-2832-25	28.0	+0.040 +0.124	32.0	25.0	28.124	28.040	32.025	32.000	28.000	27.948
PSM-3034-20	30.0	+0.040 +0.124	34.0	20.0	30.124	30.040	34.025	34.000	30.000	29.948
PSM-3034-40	30.0	+0.040 +0.124	34.0	40.0	30.124	30.040	34.025	34.000	30.000	29.948
PSM-3034-45	30.0	+0.040 +0.124	34.0	45.0	30.124	30.040	34.025	34.000	30.000	29.948
PSM-3539-40	35.0	+0.050 +0.150	39.0	40.0	35.150	35.050	39.025	39.000	35.000	34.938
PSM-4044-50	40.0	+0.050 +0.150	44.0	50.0	40.150	40.050	44.025	44.000	40.000	39.938
PSM-4044-58	40.0	+0.050 +0.150	44.0	58.0	40.150	40.050	44.025	44.000	40.000	39.938
PSM-5055-40	50.0	+0.050 +0.150	55.0	40.0	50.150	50.050	55.030	55.000	50.000	49.938
PSM-6065-60	60.0	+0.060 +0.180	65.0	60.0	60.180	60.060	65.030	65.000	60.000	59.926
PSM-7580-80	75.0	+0.060 +0.180	80.0	80.0	75.180	75.060	80.030	80.000	75.000	74.926
PSM-9095-100	90.0	+0.072 +0.212	95.0	100.0	90.212	90.072	95.035	95.000	90.000	89.913
PSM-95100-100	95.0	+0.072 +0.212	100.0	100.0	95.212	95.072	100.035	100.000	95.000	95.913

PDF: www.igus.com/iglide-pdfs
 CAD: www.igus.com/iglide-CAD
 RoHS info: www.igus.com/RoHS





iglide® Plain Bearings P - Flange, MM

iglide® P
Flange - MM

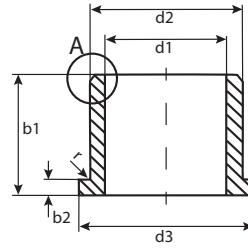
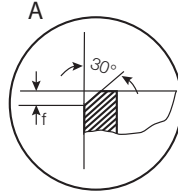

For tolerance values
please refer to page 9.4

$r = \max. 0.5$

Dimensions according to ISO 3547-1 and special dimensions

Part Number	d1 ¹⁾	d1-Tolerance After Pressfit in Ø H7	d2	d3	b1	b2	I.D. After Pressfit		Housing Bore		Shaft Size	
							Max..	Min.	Max.	Min.	Max.	Min.
PFM-0405-04	4.0	+0.020 +0.068	5.5	9.5	4.0	0.75	4.068	4.020	5.512	5.500	4.000	3.970
PFM-0507-05	5.0	+0.020 +0.068	7.0	11.0	5.0	1.0	5.068	5.020	7.015	7.000	5.000	4.970
PFM-0608-04	6.0	+0.020 +0.068	8.0	12.0	4.0	1.0	6.068	6.020	8.015	8.000	6.000	5.970
PFM-0810-10	8.0	+0.025 +0.083	10.0	15.0	10.0	1.0	8.083	8.025	10.015	10.000	8.000	7.964
PFM-081012-10	8.0	+0.025 +0.083	10.0	12.0	10.0	1.0	8.083	8.025	10.015	10.000	8.000	7.964
PFM-0810-15	8.0	+0.025 +0.083	10.0	15.0	15.0	1.0	8.083	8.025	10.018	10.000	10.000	9.964
PFM-1012-17	10.0	+0.025 +0.083	12.0	18.0	17.0	1.0	10.083	10.025	12.018	12.000	10.000	9.964
PFM-121418-08	12.0	+0.032 +0.102	14.0	18.0	8.0	1.0	12.102	12.032	14.018	14.000	12.000	11.957
PFM-1214-10	12.0	+0.032 +0.102	14.0	20.0	10.0	1.0	12.102	12.032	14.018	14.000	12.000	11.957
PFM-1214-15	12.0	+0.032 +0.102	14.0	20.0	15.0	1.0	12.102	12.032	14.018	14.000	12.000	11.957
PFM-1416-08	14.0	+0.032 +0.102	16.0	22.0	8.0	1.0	14.102	14.032	16.018	16.000	14.000	13.957
PFM-1416-12	14.0	+0.032 +0.102	16.0	22.0	12.0	1.0	14.102	14.032	16.018	16.000	14.000	13.957
PFM-141624-25	14.0	+0.032 +0.102	16.0	24.0	25.0	1.0	14.102	14.032	16.018	16.000	14.000	13.957
PFM-1517-22	15.0	+0.032 +0.102	17.0	23.0	22.0	1.0	15.102	15.032	17.018	17.000	15.000	14.957
PFM-151824-32	15.0	+0.032 +0.102	18.0	24.0	32.0	1.5	15.102	15.032	18.018	18.000	15.000	14.957
PFM-1618-12	16.0	+0.032 +0.102	18.0	24.0	12.0	1.0	16.102	16.072	18.018	18.000	16.000	15.957
PFM-1618-17	16.0	+0.032 +0.102	18.0	24.0	17.0	1.0	16.102	16.072	18.018	18.000	16.000	15.957
PFM-161824-40	16.0	+0.032 +0.102	18.0	24.0	40.0	1.0	16.102	16.032	18.018	18.000	16.000	15.957
PFM-1719-25	17.0	+0.032 +0.102	19.0	25.0	25.0	1.0	17.102	17.032	19.018	19.000	17.000	16.957
PFM-1820-17	18.0	+0.032 +0.102	20.0	26.0	17.0	1.0	18.102	18.032	20.021	20.000	18.000	17.957
PFM-2023-16	20.0	+0.040 +0.124	23.0	30.0	16.5	1.5	20.124	20.040	23.021	23.000	20.000	19.948
PFM-2023-30	20.0	+0.040 +0.124	23.0	30.0	30.0	1.5	20.124	20.040	23.021	23.000	20.000	19.948
PFM-202328-15	20.0	+0.040 +0.124	23.0	28.0	15.0	1.5	20.124	20.040	23.021	23.000	20.000	19.948
PFM-2528-21	25.0	+0.040 +0.124	28.0	35.0	21.5	1.5	25.124	25.040	28.021	28.000	25.000	24.948
PFM-283239-20	28.0	+0.040 +0.124	32.0	39.0	20.0	2.0	28.124	28.040	32.025	32.000	28.000	28.948
PFM-3034-16	30.0	+0.040 +0.124	34.0	42.0	16.0	2.0	30.124	30.040	34.025	34.000	30.000	29.948
PFM-3034-26	30.0	+0.040 +0.124	34.0	42.0	26.0	2.0	30.124	30.040	34.025	34.000	30.000	29.948
PFM-3034-37	30.0	+0.040 +0.124	34.0	42.0	37.0	2.0	30.124	30.040	34.025	34.000	30.000	29.948
PFM-3236-16	32.0	+0.050 +0.150	36.0	40.0	16.0	2.0	32.150	32.050	36.025	36.000	32.000	31.938
PFM-3539-058	35.0	+0.050 +0.150	39.0	47.0	5.8	2.0	35.150	35.050	39.025	39.000	35.000	34.938
PFM-3539-26	35.0	+0.050 +0.150	39.0	47.0	26.0	2.0	35.150	35.050	39.025	39.000	35.000	34.938
PFM-4044-40	40.0	+0.050 +0.150	44.0	52.0	40.0	2.0	40.150	40.050	44.025	44.000	40.000	39.938
PFM-5055-60	50.0	+0.050 +0.150	55.0	63.0	60.0	2.0	50.150	50.050	55.030	55.000	50.000	49.938
PFM-6065-50	60.0	+0.060 +0.180	65.0	73.0	50.0	2.0	60.180	60.060	65.030	65.000	60.000	59.926
PFM-7075-50	70.0	+0.060 +0.180	75.0	83.0	50.0	2.0	70.180	70.060	75.030	75.000	70.000	69.926
PFM-8085-100	80.0	+0.060 +0.180	85.0	93.0	100.0	2.5	80.180	80.060	85.030	85.000	80.000	79.926

Telephone 1-800-521-2747
Fax 1-401-438-7270

Internet: <http://www.igus.com>
email: sales@igus.com
QuickSpec: <http://www.igus.com/iglide-quickspec>

igus[®]



iglide[®] H370

Product Range

- Standard Styles:
Sleeve, Flange
- Custom shapes and sizes available
- Inner diameters:
Inch sizes from 1/8 - 1-1/4 in.
Metric sizes from 3 - 75 mm

Part Number Structure

Part Number Structure

H370 S I - 02 03 - 03

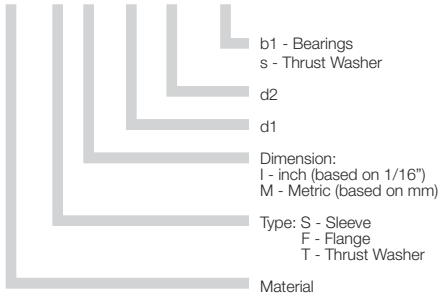

Permissible Surface Speeds

	Continuous fpm	Short Term fpm
Rotating	236	295
Oscillating	157	216
Linear	787	984

Usage Guidelines



- For use underwater
- When high temperature resistance is necessary
- When high mechanical loading and wear resistance is required
- For use in contact with chemicals



- When mechanical reaming of the wall surface is necessary
➤ iglide® M250
- When high wear resistance is needed
➤ iglide® L280
- For use in dirty surroundings
➤ iglide® M250



Visit www.igus.com
to use our online
expert system

Material Data

General Properties	Unit	iglide® H370	Testing Method
Density	g/cm ³	1.60	
Color		gray	
Max. moisture absorption at 73°F / 50% r.h.	% weight	< 0.1	DIN 53495
Max. moisture absorption	% weight	< 0.1	
Coefficient of friction, dynamic against steel	μ	0.07 - 0.17	
p x v value, max. (dry)	psi x fpm	21,000	

Mechanical Properties

Modulus of elasticity	psi	1,609,919	DIN 53457
Tensile strength at 68°F	psi	19,575	DIN 53452
Compressive strength	psi	11,455	
Permissible static surface pressure (68°C)	psi	10,875	
Shore D-hardness		82	DIN 53505

Physical and Thermal Properties

Max. long-term application temperature	°F	392	
Max. short-term application temperature	°F	464	
Min. application Temperature	°F	-40	
Thermal conductivity	W/m x K	0.5	ASTM C 177
Coefficient of thermal expansion	K ⁻¹ x 10 ⁻⁵	5	DIN 53752

Electrical Properties

Specific volume resistance	Ωcm	< 10 ⁵	DIN IEC 93
Surface resistance	Ω	< 10 ⁵	DIN 53482

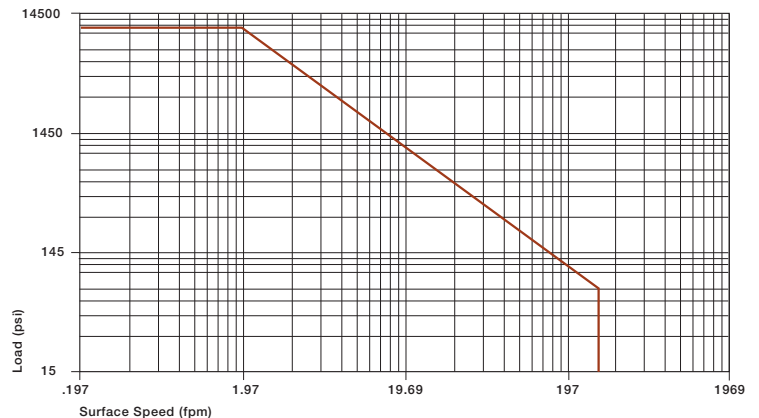

Graph 10.1: Permissible p x v value for iglide® H370 running dry against a steel shaft, at 68°F

The iglide® H370 is a further development of the iglide® H series. The material is characterized by very low water absorption and clearly improved wear resistance. In terms of the mechanical and thermal characteristic values, iglide® H370 shows the same properties as iglide® H (see 10.1)

Compressive Strength

Graph 10.2 shows the elastic deformation of iglide® H370 for radial loads. At the maximum permissible load of 10875 psi, the deformation is approximately 2.5% at room temperature.

➤ Compressive Strength, Page 1.3

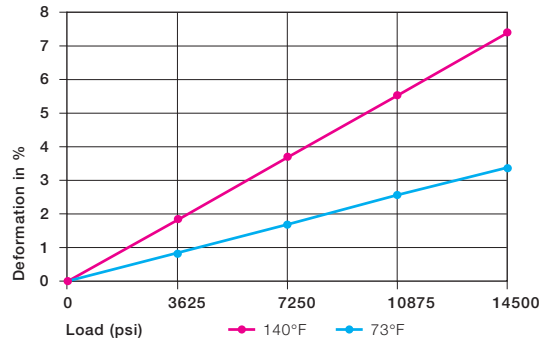

Graph 10.2: Deformation under load and temperature

Permissible Surface Speeds

The maximum permissible surface speed depends on the temperature during operation. iglide® H370 is able to run at speeds of up to 197 fpm (rotating) to 787 fpm (linear)

➤ Surface Speed, Page 1.5
➤ p x v value, Page 1.6

	Continuous fpm	Short Term fpm
Rotating	236	295
Oscillating	157	216
Linear	787	984

Table 10.2: Maximum surface speeds

Temperatures

iglide® H370 is an extremely temperature-resistant material. With a maximum permissible short-term temperature of 464°F, iglide® H370 plain bearings may be subjected to a heat treating process without additional load. With increasing temperatures, the compressive strength of iglide® H370 plain bearings decreases. Graph 10.3 shows this relationship.

The ambient temperatures prevalent in the bearing system also have an effect on the bearing wear. With increasing temperatures, the wear increases.

iglide® H370 loses approximately 75% of its compressive strength when the temperature increases from room temperature to 302°F. On the other hand, there is little change in wear resistance at the same temperature range.

➤ Application Temperatures, Page 1.7

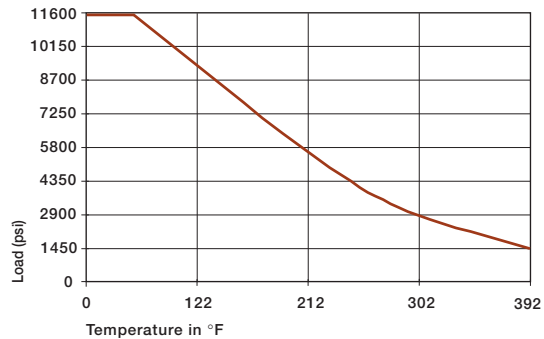

Graph 10.3: Recommended permissible maximum static surface pressure of iglide® H370 as a result of the temperature

iglide® H370	Application Temperature
Minimum	- 40 °F
Max. long-term	+ 392 °F
Max. short-term	+ 464 °F

Table 10.3: Temperature limits for iglide® H370

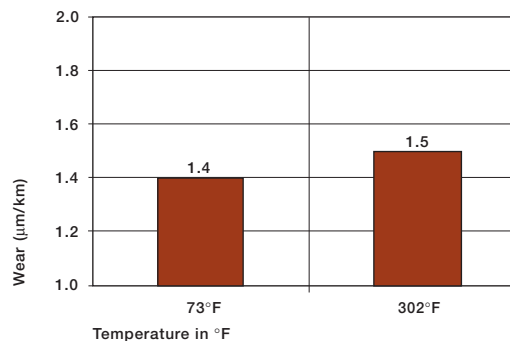

Graph 10.4 : Wear as a result of the temperature; rotation with p = 108 psi and v = 98 fpm

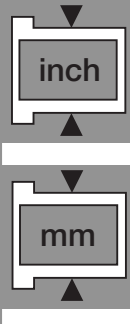
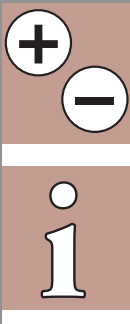

Installation Tolerances

iglide® H370 plain bearings are oversized before being pressfit. After proper installation into a recommended housing bore, the inner diameter adjusts to meet our specified tolerances. Please adhere to the catalog specifications for housing bore and recommended shaft sizes. This will help to ensure optimal performance of iglide® plain bearings.

- See Tolerance Table, Page 1.14
- Testing Methods, Page 1.15

For Inch Size Bearings		
Length Tolerance (b1)	Tolerance (h13)	Length of Chamfer (f)
Length (inches)	(inches)	Based on d1
0.1181 to 0.2362	-0.0000 /-0.0071	f = .012 → d ₁ .040" - .236"
0.2362 to 0.3937	-0.0000 /-0.0087	f = .019 → d ₁ > .236" - .472"
0.3937 to 0.7086	-0.0000 /-0.0106	f = .031 → d ₁ > .472" - 1.18"
0.7086 to 1.1811	-0.0000 /-0.0130	f = .047 → d ₁ > 1.18"
1.1811 to 1.9685	-0.0000 /-0.0154	
1.9685 to 3.1496	-0.0000 /-0.0181	

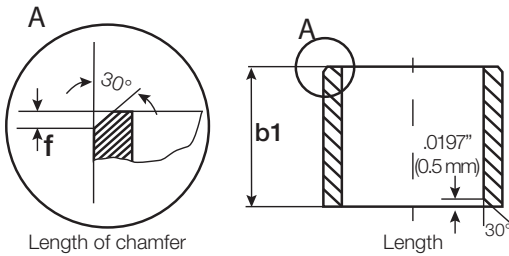

For Metric Size Bearings		
Length Tolerance (b1)	Tolerance (h13)	Length of Chamfer (f)
Length (mm)	(µm)	Based on d1
1 to 3	-0 /-140	f = 0.3 → d ₁ 1 - 6 mm
> 3 to 6	-0 /-180	f = 0.5 → d ₁ > 6 - 12 mm
> 6 to 10	-0 /-220	f = 0.8 → d ₁ > 12 - 30 mm
> 10 to 18	-0 /-270	
> 18 to 30	-0 /-330	
> 30 to 50	-0 /-390	
> 50 to 80	-0 /-460	

Friction and Wear

The friction and wear values are better for iglide® H370 than for iglide® H. Especially for underwater applications, there is no better material than iglide® H370. The coefficient of friction and wear resistance show little effect with increased speed and load. This relationship explains the excellent performance of iglide® H370 plain bearings at high loads.

Friction and wear are also dependent, to a large degree, on the shafting partner. Shafts that are too smooth increase both the coefficient of friction and the wear of the bearing. For iglide® H370 a ground surface with an average roughness range of 8-16 rms is recommended for the shaft.

- Coefficients of Friction and Surface, Page 1.8
- Wear Resistance, Page 1.9

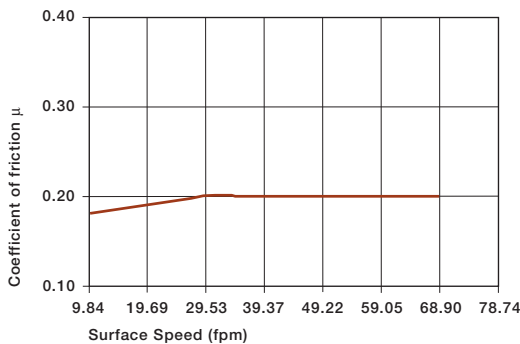

Graph 10.5: Coefficients of friction for iglide® H370 as a result of the surface speed; p = 108 psi

iglide® H370	Coefficient of Friction
Dry	0.07 - 0.17
Grease	0.09
Oil	0.04
Water	0.04

Table 10.4: Coefficients of friction for iglide® H370 against steel (Shaft finish = 40 rms, 50 HRC)

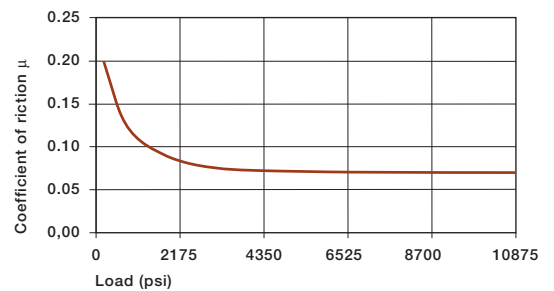

Graph 10.6: Coefficients of friction for iglide® H370 as a result of the load, v = 1.97 fpm

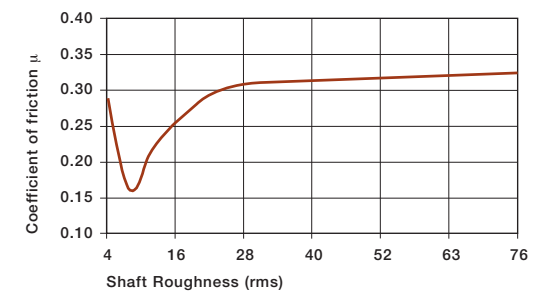

Graph 10.7: Coefficient of friction of iglide® H370 as a result of the shaft surface (shaft Cold Rolled Steel)

Shaft Materials

Graph 10.7 and 10.8 show results of testing different shaft materials with plain bearings made of iglide® H370.

For loads up to 290 psi, A hard-chromed shaft is the best material for iglide® H370 in rotating applications. Note the high wear values for 303 Stainless shafts, which have a tendency to stick-slip because of their very smooth surfaces. The HR Carbon Steel shaft has better rotational values than Cold Rolled Steel starting at 290 psi. On the other hand, for oscillating movements, the 303 Stainless Steel shaft has a clear superiority. As the graph shows, it produces, at 290 psi, a lower wear by a factor of 11 than the Cold Rolled Steel shaft.

If the shaft material you plan to use is not contained in this list, please contact us.

➤ Shaft materials, Page 1.11

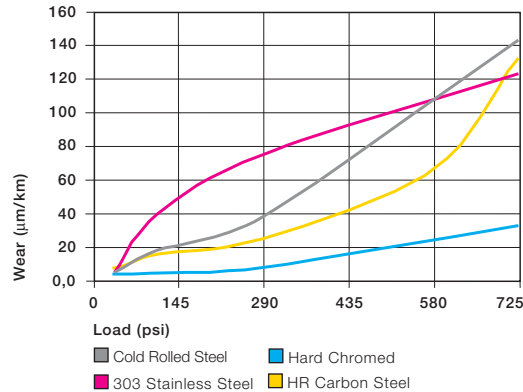

Graph 10.9: Wear of iglide® H370 with different shaft materials in rotating applications

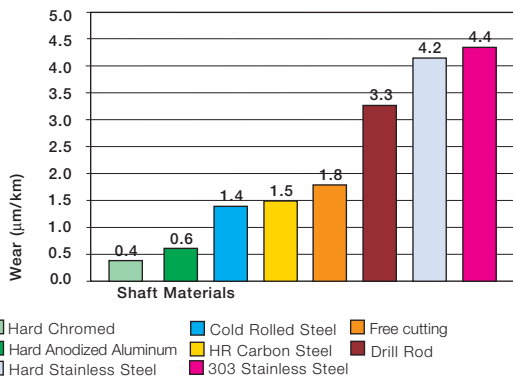

Graph 10.8: Wear of iglide® H370, rotating application with different shaft materials, p=108 psi, v=98 fpm

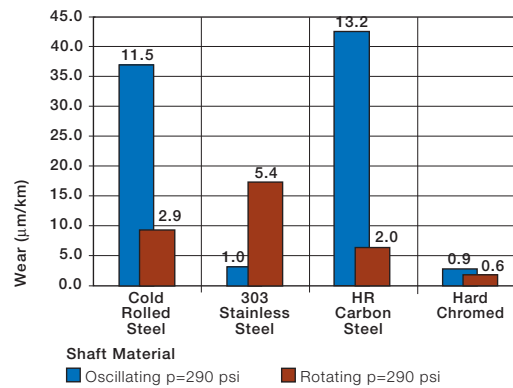

Graph 10.10: Wear for oscillating and rotating applications with different shaft materials p = 290 psi

Chemical Resistance

iglide® H370 plain bearings have a good chemical resistance. They are resistant to most lubricants, iglide® H370 is also resistant to most weak organic and inorganic acids.

The moisture absorption of iglide® H370 plain bearings is below 0.1% in standard atmosphere. The saturation limit in water is also below 0.1%. For this reason, iglide® H370 plain bearings are often used for underwater applications.

➤ Chemical Table, Page 1.16

Medium	Resistance
Alcohol	+
Hydrocarbons, chlorinated	+
Greases, oils without additives	+
Fuels	+
Weak acids	+ to 0
Strong acids	+ to -
Weak alkaline	+
Strong alkaline	+

+ resistant, 0 conditionally resistant, - not resistant

Table 10.5: Chemical resistance of iglide® H370
All data given concerns the chemical resistance at room temperature (68°F). For a complete list, see page 1.16

PDF: www.igus.com/iglide-pdfs
CAD: www.igus.com/iglide-CAD
RoHS info: www.igus.com/RoHS

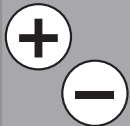



Radiation Resistance

iglide® H370 withstands neutron and gamma particle radiation without detectable losses to its excellent mechanical properties. Plain bearings made from iglide® H370 are resistant to radiation up to an intensity of 2×10^2 Gy

UV-Resistance

iglide® H370 plain bearings are permanently resistant against UV radiation.

Vacuum

In a vacuum environment, moisture is released as a vapor. However, due to its low moisture absorption, use in a vacuum is possible.

Electrical Properties

iglide® H370 plain bearings are electrically conducting.

iglide® H370

Specific volume resistance	< $10^5 \Omega\text{cm}$
Surface resistance	< $10^5 \Omega$

Table 10.6: Electrical properties of iglide® H370

Application Example



Picture 10.1: Filling applications: linear, oscillating, and rotating movements can be achieved using iglide® H370 bearings

iglide® Plain Bearings H370 - Sleeve, Inch



iglide® H370
Sleeve - Inch

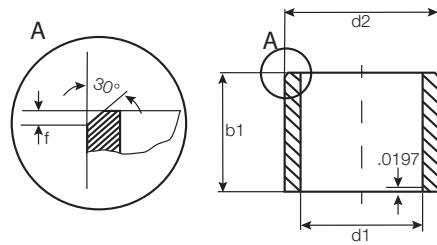

For tolerance values
please refer to page 10.4

Part Number	d1 After Pressfit in Ø H7	d2	b1 h13	I.D. After Pressfit		Housing Bore		Shaft Size	
				Max.	Min.	Max.	Min.	Max.	Min.
H370SI-0203-03	1/8	3/16	3/16	.1269	.1251	.1878	.1873	.1243	.1236
H370SI-0304-04	3/16	1/4	1/4	.1892	.1873	.2503	.2497	.1865	.1858
H370SI-0405-04	1/4	5/16	1/4	.2521	.2498	.3128	.3122	.2490	.2481
H370SI-0506-06	5/16	3/8	3/8	.3148	.3125	.3753	.3747	.3115	.3106
H370SI-0607-08	3/8	15/32	1/2	.3773	.3750	.4691	.4684	.3740	.3731
H370SI-0809-08	1/2	19/32	1/2	.5030	.5003	.5941	.5934	.4990	.4980
H370SI-1011-12	5/8	23/32	3/4	.6280	.6253	.7192	.7184	.6240	.6230
H370SI-1214-12	3/4	7/8	3/4	.7541	.7505	.8755	.8747	.7491	.7479
H370SI-1416-16	7/8	1	1	.8791	.8757	1.0005	.9997	.8741	.8729
H370SI-1618-16	1	1 1/8	1	1.0041	1.0007	1.1255	1.1247	.9991	.9979
H370SI-2022-20	1 1/4	1 13/32	1 1/4	1.2548	1.2508	1.4068	1.4058	1.2488	1.2472

iglide® Plain Bearings H370 - Flange, Inch

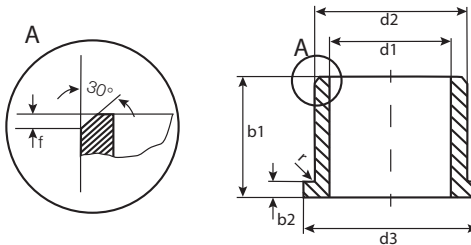

For tolerance values
please refer to page 10.4

r = max. .0197

Part Number	d1	d2	b1	d3	b2 -.0055	I.D. After Pressfit		Housing Bore		Shaft Size	
						Max.	Min.	Max.	Min.	Max.	Min.
H370FI-0203-03	1/8	3/16	3/16	.312	.032	.1269	.1251	.1878	.1873	.1243	.1236
H370FI-0304-04	3/16	1/4	1/4	.375	.032	.1892	.1873	.2503	.2497	.1865	.1858
H370FI-0405-04	1/4	5/16	1/4	.500	.032	.2521	.2498	.3128	.3122	.2490	.2481
H370FI-0506-06	5/16	3/8	3/8	.562	.032	.3148	.3125	.3753	.3747	.3115	.3106
H370FI-0607-08	3/8	15/32	1/2	.687	.046	.3773	.3750	.4691	.4684	.3740	.3731
H370FI-0809-08	1/2	19/32	1/2	.875	.046	.5030	.5003	.5941	.5934	.4990	.4980
H370FI-1011-12	5/8	23/32	3/4	1.000	.046	.6280	.6253	.7192	.7184	.6240	.6230
H370FI-1214-12	3/4	7/8	3/4	1.125	.062	.7541	.7505	.8755	.8747	.7491	.7479
H370FI-1416-16	7/8	1	1	1.250	.062	.8791	.8757	1.0005	.9997	.8741	.8729
H370FI-1618-16	1	1 1/8	1	1.375	.062	1.0041	1.0007	1.1255	1.1247	.9991	.9979
H370FI-2022-20	1 1/4	1 13/32	1 1/4	1.687	.078	1.2548	1.2508	1.4068	1.4058	1.2488	1.2472

PDF: www.igus.com/iglide-pdfs
CAD: www.igus.com/iglide-CAD
RoHS info: www.igus.com/RoHS

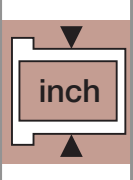

H370



iglide® Plain Bearings H370 - Sleeve, MM

iglide® H370
Sleeve - MM

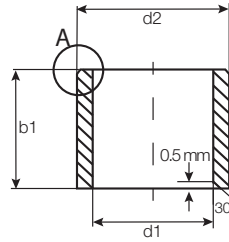
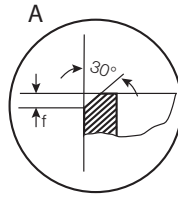

For tolerance values
please refer to page 10.4

Dimensions according to ISO 3547-1 and special dimensions

Part number	d1		d2	b1 h13	I.D. After Pressfit		Housing Bore		Shaft Size	
	after Pressfit in Ø H7				Max.	Min.	Max.	Min.	Max.	Min.
H370SM-0304-03	3.0	+0.006 +0.046	4.5	3.0	3.046	3.006	4.512	4.500	3.000	2.975
H370SM-0405-04	4.0	+0.010 +0.058	5.5	4.0	4.058	4.010	5.512	5.500	4.000	3.970
H370SM-0405-12	4.0	+0.010 +0.058	5.5	4.0	4.058	4.010	5.512	5.500	4.000	3.970
H370SM-0507-05	5.0	+0.010 +0.058	7.0	5.0	5.058	5.010	7.015	7.000	5.000	4.970
H370SM-0608-06	6.0	+0.010 +0.058	8.0	6.0	6.058	6.010	8.015	8.000	6.000	5.970
H370SM-0608-10	6.0	+0.010 +0.058	8.0	10.0	6.058	6.010	8.015	8.000	6.000	5.970
H370SM-0810-08	8.0	+0.013 +0.071	10.0	8.0	8.071	8.013	10.015	10.000	8.000	7.964
H370SM-0810-10	8.0	+0.013 +0.071	10.0	10.0	8.071	8.013	10.015	10.000	8.000	7.964
H370SM-0810-15	8.0	+0.013 +0.071	10.0	15.0	8.071	8.013	10.015	10.000	8.000	7.964
H370SM-1012-06	10.0	+0.013 +0.071	12.0	6.0	10.071	10.013	12.018	12.000	10.000	9.964
H370SM-1012-10	10.0	+0.013 +0.071	12.0	10.0	10.071	10.013	12.018	12.000	10.000	9.964
H370SM-1012-15	10.0	+0.013 +0.071	12.0	15.0	10.071	10.013	12.018	12.000	10.000	9.964
H370SM-1214-10	12.0	+0.016 +0.086	14.0	10.0	12.086	12.016	14.018	14.000	12.000	11.957
H370SM-1214-15	12.0	+0.016 +0.086	14.0	15.0	12.086	12.016	14.018	14.000	12.000	11.957
H370SM-1416-20	14.0	+0.016 +0.086	16.0	20.0	14.086	14.016	16.018	16.000	14.000	13.957
H370SM-1517-15	15.0	+0.016 +0.086	17.0	15.0	15.086	15.016	17.018	17.000	15.000	14.957
H370SM-1618-15	16.0	+0.016 +0.086	18.0	15.0	16.086	16.016	18.018	18.000	16.000	15.957
H370SM-1618-20	16.0	+0.016 +0.086	18.0	20.0	16.086	16.016	18.018	18.000	16.000	15.957
H370SM-1820-15	18.0	+0.016 +0.086	20.0	15.0	18.086	18.016	20.021	20.000	18.000	17.957
H370SM-2023-20	20.0	+0.020 +0.104	23.0	20.0	20.104	20.020	23.021	23.000	20.000	19.948
H370SM-2528-20	25.0	+0.020 +0.104	28.0	20.0	25.104	25.020	28.021	28.000	25.000	24.948
H370SM-2832-20	28.0	+0.020 +0.104	32.0	20.0	28.104	28.020	32.021	32.000	28.000	27.948
H370SM-3034-30	30.0	+0.020 +0.104	34.0	30.0	30.104	30.020	34.025	34.000	30.000	29.948
H370SM-3236-30	32.0	+0.025 +0.125	36.0	30.0	32.125	32.025	36.025	36.000	32.000	31.938
H370SM-3539-40	35.0	+0.025 +0.125	39.0	40.0	35.125	35.025	39.025	39.000	35.000	34.938
H370SM-4044-50	40.0	+0.025 +0.125	44.0	50.0	40.125	40.025	44.025	44.000	40.000	39.938
H370SM-4550-30	45.0	+0.025 +0.125	50.0	30.0	45.125	45.025	50.025	50.000	45.000	44.938
H370SM-5055-40	50.0	+0.025 +0.125	55.0	40.0	50.125	50.025	55.030	55.000	50.000	49.938
H370SM-5055-60	55.0	+0.025 +0.125	55.0	60.0	50.125	50.025	55.030	55.000	50.000	49.938
H370SM-5560-26	55.0	+0.030 +0.150	60.0	26.0	55.150	55.030	60.030	60.000	55.000	54.926
H370SM-6065-60	60.0	+0.030 +0.150	65.0	60.0	60.150	60.030	65.030	65.000	60.000	59.926
H370SM-7580-60	75.0	+0.030 +0.150	80.0	60.0	75.150	75.030	80.030	80.000	75.000	74.926

Telephone 1-800-521-2747
Fax 1-401-438-7270

Internet: <http://www.igus.com>
email: sales@igus.com
QuickSpec: <http://www.igus.com/iglide-quickspec>

iglide® Plain Bearings H370 - Flange, MM

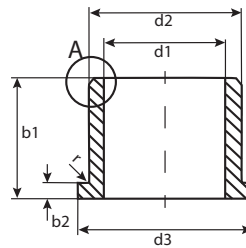
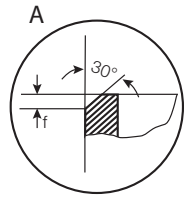

For tolerance values
please refer to page 10.4

r = max. 0.5

Dimensions according to ISO 3547-1 and special dimensions

Part Number	d1 ¹⁾		d2	d3	b1	b2	I.D. After Pressfit		Housing Bore		Shaft Size	
	After Pressfit in Ø H7						Max.	Min.	Max.	Min.	Max.	Min.
H370FM-0405-04	4.0	+0.010 +0.058	5.5	9.5	4.0	0.75	4.058	4.010	5.512	5.500	4.000	3.970
H370FM-0507-05	5.0	+0.010 +0.058	7.0	11.0	5.0	1.0	5.058	5.010	7.015	7.000	5.000	4.970
H370FM-0608-06	6.0	+0.010 +0.058	8.0	12.0	6.0	1.0	6.058	6.010	8.015	8.000	6.000	5.970
H370FM-0608-10	6.0	+0.010 +0.058	8.0	12.0	10.0	1.0	6.058	6.010	8.015	8.000	6.000	5.970
H370FM-0810-06	8.0	+0.013 +0.071	10.0	15.0	6.0	1.0	8.071	8.013	10.015	10.000	8.000	7.964
H370FM-0810-07	8.0	+0.013 +0.071	10.0	15.0	7.0	1.0	8.071	8.013	10.015	10.000	8.000	7.964
H370FM-0810-10	8.0	+0.013 +0.071	10.0	15.0	10.0	1.0	8.071	8.013	10.015	10.000	8.000	7.964
H370FM-0810-15	8.0	+0.013 +0.071	10.0	15.0	15.0	1.0	8.071	8.013	10.015	10.000	8.000	7.964
H370FM-1012-10	10.0	+0.013 +0.071	12.0	18.0	10.0	1.0	10.071	10.013	12.018	12.000	10.000	9.964
H370FM-1012-15	10.0	+0.013 +0.071	12.0	18.0	15.0	1.0	10.071	10.013	12.018	12.000	10.000	9.964
H370FM-1012-20	10.0	+0.013 +0.071	12.0	18.0	20.0	1.0	10.071	10.013	12.018	12.000	10.000	9.964
H370FM-1214-07	12.0	+0.016 +0.086	14.0	20.0	7.0	1.0	12.086	12.016	14.018	14.000	12.000	11.957
H370FM-1214-12	12.0	+0.016 +0.086	14.0	20.0	12.0	1.0	12.086	12.016	14.018	14.000	12.000	11.957
H370FM-1214-15	12.0	+0.016 +0.086	14.0	20.0	15.0	1.0	12.086	12.016	14.018	14.000	12.000	11.957
H370FM-1214-20	12.0	+0.016 +0.086	14.0	20.0	20.0	1.0	12.086	12.016	14.018	14.000	12.000	11.957
H370FM-1416-12	14.0	+0.016 +0.086	16.0	22.0	12.0	1.0	14.086	14.016	16.018	16.000	14.000	13.957
H370FM-1517-17	15.0	+0.016 +0.086	17.0	23.0	17.0	1.0	15.086	15.016	17.018	17.000	15.000	14.957
H370FM-1618-10	16.0	+0.016 +0.086	18.0	24.0	10.0	1.0	16.086	16.016	18.018	18.000	16.000	15.957
H370FM-1618-17	16.0	+0.016 +0.086	18.0	24.0	17.0	1.0	16.086	16.016	18.018	18.000	16.000	15.957
H370FM-1820-12	18.0	+0.016 +0.086	20.0	26.0	12.0	1.0	18.086	18.016	20.021	20.000	18.000	17.957
H370FM-1820-17	18.0	+0.016 +0.086	20.0	26.0	17.0	1.0	18.086	18.016	20.021	20.000	18.000	17.957
H370FM-2023-16	20.0	+0.020 +0.104	23.0	30.0	16.0	1.5	20.104	20.020	23.021	23.000	20.000	19.948
H370FM-2023-21	20.0	+0.020 +0.104	23.0	30.0	21.0	1.5	20.104	20.020	23.021	23.000	20.000	19.948
H370FM-2023-30	20.0	+0.020 +0.104	23.0	30.0	30.0	1.5	20.104	20.020	23.021	23.000	20.000	19.948
H370FM-2528-30	25.0	+0.020 +0.104	28.0	35.0	30.0	1.5	25.104	25.020	28.021	28.000	25.000	24.948
H370FM-3034-40	30.0	+0.020 +0.104	34.0	42.0	40.0	2.0	30.104	30.020	34.021	34.000	30.000	29.948
H370FM-3539-26	35.0	+0.025 +0.125	39.0	47.0	26.0	2.0	35.125	35.025	39.025	39.000	35.000	34.938
H370FM-4044-40	40.0	+0.025 +0.125	44.0	52.0	40.0	2.0	40.125	40.025	44.025	44.000	40.000	39.938
H370FM-5055-50	50.0	+0.025 +0.125	55.0	63.0	50.0	2.0	50.125	50.025	55.030	55.000	50.000	49.938
H370FM-6065-50	60.0	+0.030 +0.150	65.0	73.0	50.0	2.0	60.150	60.030	65.030	65.000	60.000	59.926
H370FM-7075-50	70.0	+0.030 +0.150	75.0	83.0	50.0	2.0	70.150	70.030	75.030	75.000	70.000	69.926

iglide® H370
Flange - MM

PDF: www.igus.com/iglide-pdfs
CAD: www.igus.com/iglide-CAD
RoHS info: www.igus.com/RoHS





iglide® Plain Bearings
H370 - Notes

iglide® H370

Telephone 1-800-521-2747
Fax 1-401-438-7270

Internet: <http://www.igus.com>
email: sales@igus.com
QuickSpec: <http://www.igus.com/iglide-quickspec>

igus[®]



iglide[®] A180

Product Range

- Standard Styles:
Sleeve, Flange
- Custom shapes and sizes available
- Inner diameters:
Inch sizes from 1/8 - 1-3/4 in.
Metric sizes from 1 - 32 mm

Part Number Structure

Part Number Structure

A180 S I - 02 04 - 04

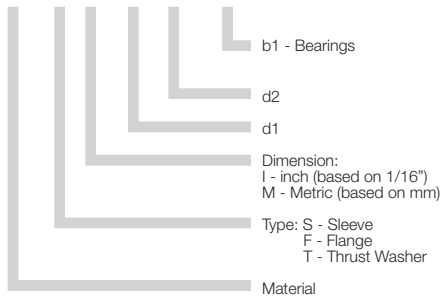

Permissible Surface Speeds

	Continuous fpm	Short Term fpm
Rotating	157	236
Oscillating	118	197
Linear	689	984

Usage Guidelines



- When your bearing comes in direct contact with food or pharmaceuticals
- If FDA-compliance is required
- When quiet operation is important
- If low water absorption is needed



- When the maximum abrasion resistance is necessary
➤ iglide® J
- When temperatures are continuously greater than 176°F
➤ iglide® A290, A500
- When a cost-effective universal bearing is desired
➤ iglide® G300
➤ iglide® P



Visit www.igus.com to use our online expert system

Material Data

General Properties	Unit	iglide® A200	Testing Method
Density	g/cm ³	1.46	
Color		white	
Max. moisture absorption at 73°F / 50% r.h.	% weight	0.2	DIN 53495
Max. moisture absorption	% weight	1.3	
Coefficient of friction, dynamic against steel	μ	0.05 - 0.23	
p x v value, max. (dry)	psi x fpm	8750	

Mechanical Properties

Modulus of elasticity	psi	333,600	DIN 53457
Tensile strength 68°F	psi	12,760	DIN 53452
Compressive strength	psi	11,312	
Permissible static surface pressure (68°F)	psi	2,900	
Shore D-hardness		76	DIN 53505

Physical and Thermal Properties

Max. long-term application temperature	°F	194	
Max. short-term application temperature	°F	230	
Min. application temperature	°F	-58	
Thermal conductivity	[W/m x K]	0.25	ASTM C 177
Coefficient of thermal expansion (at 73°F)	[K ⁻¹ x 10 ⁻⁵]	11	DIN 53752

Electrical Properties

Specific volume resistance	Ωcm	> 10 ¹²	DIN IEC 93
Surface resistance	Ω	> 10 ¹¹	DIN 53482

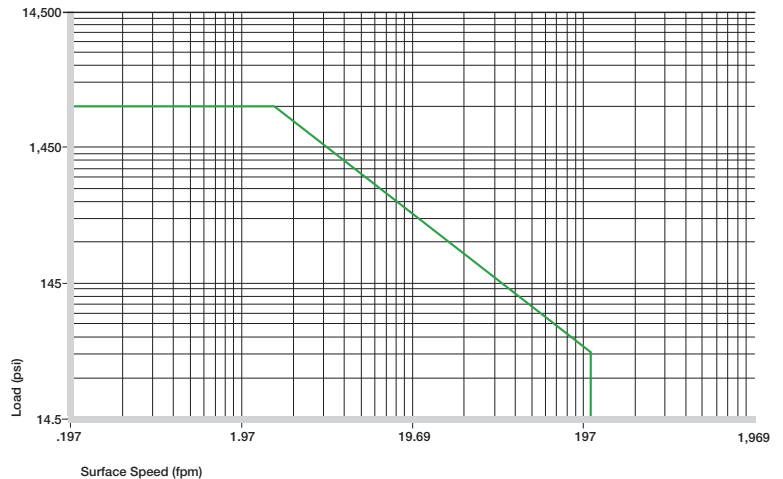

Graph 12.1: Permissible p x v values for iglide® A200 running dry against a steel shaft, at 68°F



iglide® A180 is FDA compliant

Bearings made of iglide® A180 are suitable for application in direct contact with foods. Therefore, they are the ideal solution for bearing positions on machines for the food and packaging industries, the medical equipment manufacturing, for small equipment for households, etc.

Compressive Strength

The iglide® A180 distinguishes itself also in wet cleaning or where process-dependent contact with wet media is the business of the day by its extremely low humidity absorption

The graph at the right shows the elastic deformation of iglide® A180 during radial loading. At the recommended maximum surface pressure of 2900 psi the deformation is less than 2.5 %.

Plastic deformation is minimal up to this radial load. However, it is also a result of the service time.

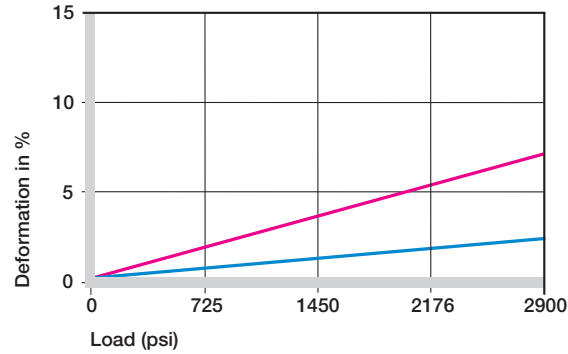

Graph 12.2: Deformation under load and temperature

➤ Compressive Strength, Page 1.3

Permissible Surface Speeds

iglide® A180 is developed for low surface speeds. Maximum speeds up to 157 fpm (rotating) and 689 fpm (linear) respectively are permitted for continuous application in dry operation.

These given values indicate the limits at which an increase up to the continuous permissible temperature occurs. In practice these limit values are not always reached due to interactions

	Continuous fpm	Short Term fpm
Rotating	157	236
Oscillating	118	197
Linear	689	984

Table 12.2: Maximum surface speeds

➤ Surface Speed, Page 1.5
➤ $p \times v$ value, Page 1.6

Temperatures

The short-term permitted maximum temperature is +230 °F. With increasing temperatures, the compressive strength of iglide® A180 bearings decreases. The graph at the right shows this relationship. The temperatures prevalent in the bearing system also have an effect on the bearing wear.

➤ Application Temperatures, Page 1.7

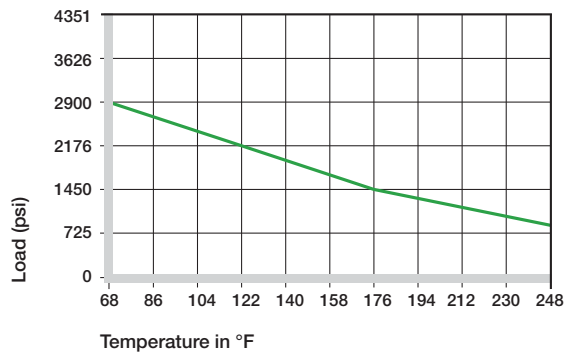

Graph 12.3: Recommended maximum permissible static surface pressure of iglide® A200 as a result of the temperature

iglide® A200	Application Temperature
Minimum	-58°F
Max. long-term	+194°F
Max. short-term	+230°F

Table 12.3: Temperature iglide® A200

PDF: www.igus.com/iglide-pdfs
CAD: www.igus.com/iglide-CAD
RoHS info: www.igus.com/RoHS

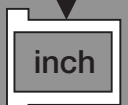

Installation Tolerances

iglide® A180 plain bearings are meant to be oversized before being pressfit. After proper installation into a recommended housing bore, the inner diameter adjusts to meet our specified tolerances. Please adhere to the catalog specifications for housing bore and recommended shaft sizes. This will help to ensure optimal performance of iglide® plain bearings.

- ▶ See Tolerance Table, Page 1.14
- ▶ Testing Methods, Page 1.15

For Inch Size Bearings		
Length Tolerance (b1)		Length of Chamfer (f)
Length (inches)	Tolerance (h13) (inches)	Based on d1
0.1181 to 0.2362	-0.0000 /-0.0071	f = .012 → d ₁ .040" - .236"
0.2362 to 0.3937	-0.0000 /-0.0087	f = .019 → d ₁ > .236" - .472"
0.3937 to 0.7086	-0.0000 /-0.0106	f = .031 → d ₁ > .472" - 1.18"
0.7086 to 1.1811	-0.0000 /-0.0130	f = .047 → d ₁ > 1.18"
1.1811 to 1.9685	-0.0000 /-0.0154	
1.9685 to 3.1496	-0.0000 /-0.0181	

For Metric Size Bearings		
Length Tolerance (b1)		Length of Chamfer (f)
Length (mm)	Tolerance (h13) (µm)	Based on d1
1 to 3	-0 /-140	f = 0.3 → d ₁ 1 - 6 mm
>3 to 6	-0 /-180	f = 0.5 → d ₁ > 6 - 12 mm
>6 to 10	-0 /-220	f = 0.8 → d ₁ > 12 - 30 mm
>10 to 18	-0 /-270	f = 1.2 → d ₁ > 30 mm
>18 to 30	-0 /-330	
>30 to 50	-0 /-390	
>50 to 80	-0 /-460	

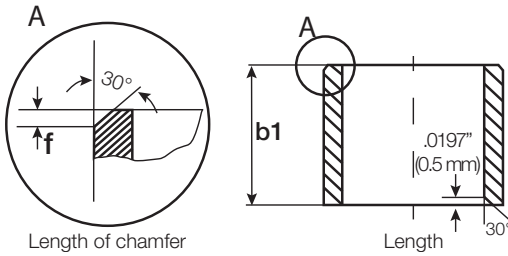

Friction and Wear

Similar to wear resistance, the coefficient of friction also changes with the load. For iglide® A180 plain bearings, the coefficient of friction μ decreases slightly with increasing load. Friction and wear are also dependent to a large degree on the shafting partner. Shafts that are too smooth not only increase the coefficient of friction, they can also increase the wear of the bearing. For iglide® A180 a ground surface with an average roughness range of 16-24 rms is recommended for the shaft.

- ▶ Coefficients of Friction and Surfaces, Page 1.8
- ▶ Wear Resistance, Page 1.9

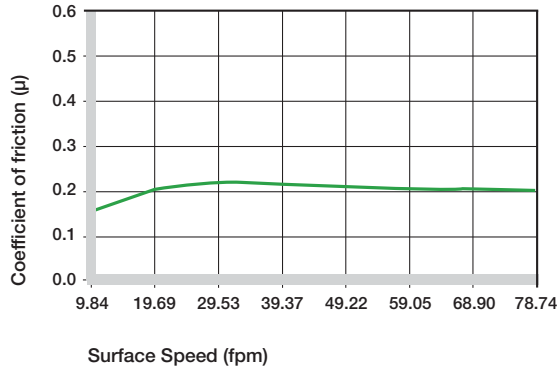

Graph 11.4: Coefficients of friction of iglide® A180 as a function of the running speed; p = 108 psi

iglide® A200	Coefficient of Friction
Dry	0.05 - 0.23
Grease	0.09
Oil	0.04
Water	0.04

Table 11.4: Coefficient of friction of iglide® A180 against steel (Shaft finish = 1 µm, 50 HRC)

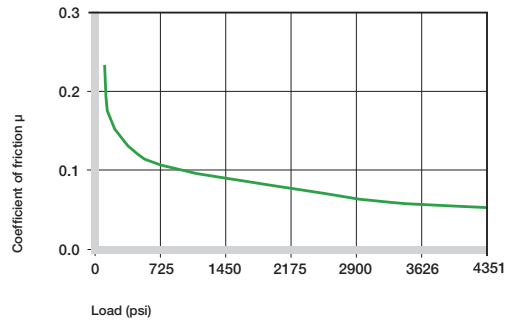

Graph 11.5: Coefficients of friction of iglide® A180 as a function of the load, v = 0.01 m/s

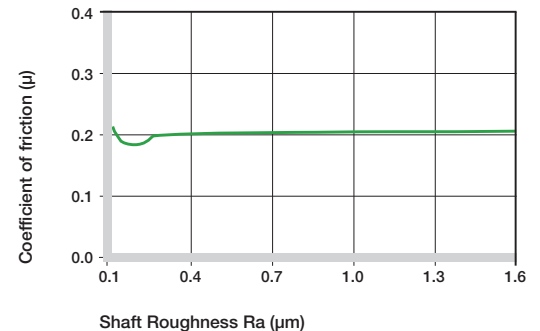

Graph 11.6: Coefficients of friction of iglide® A180 as a function of the shaft surface (shaft Cold Rolled Steel)

Shaft Materials

Graph 11.7 and 11.9 show the test results of iglide® A180 bearings running against various shaft materials.

The combination of iglide® A180 and hard-anodized aluminum clearly stands out. It attains good to excellent wear rates also with other shafts.

With Cf53 shafts, the higher wear in pivoting applications is exemplary compared to rotating applications. Graph 11.8 clearly shows, in the example of the V2A shafts, the direct increase in wear with rising load with “soft” shafts. The increase is hardly noticeable with hard shafts.

➤ Shaft Materials, Page 1.11

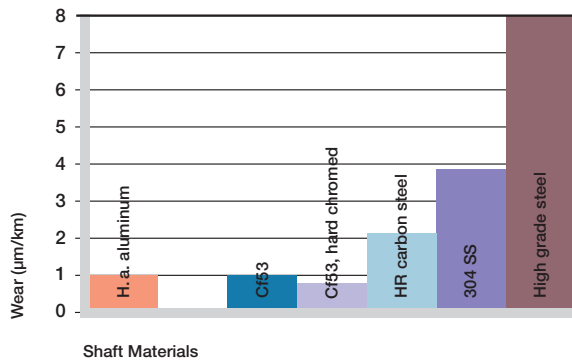

Graph 11.7: Wear of iglide® A180, rotating applications with different shaft materials, p=108 psi, v=98 fpm

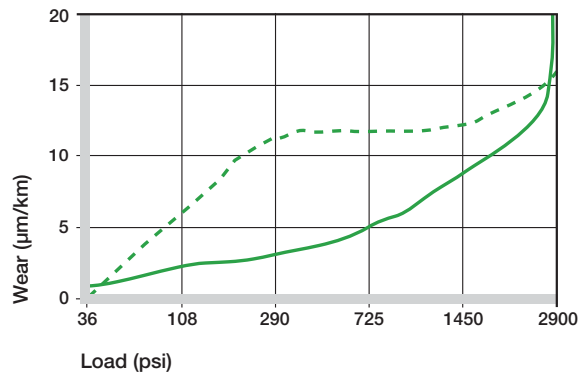

Graph 11.8: Wear of iglide® A180 with different shaft materials in rotational applications

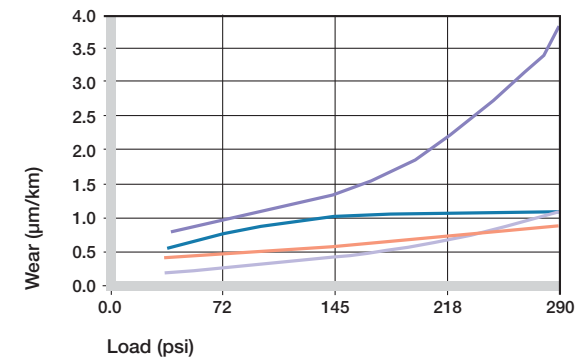

Graph 11.9: Wear with different shaft materials, oscillating and rotating movement p = 290 psi

Chemical Resistance

iglide® A180 bearings can be used under various environmental conditions and in contact with numerous chemicals. Table 11.5 gives an overview of the chemical resistance of iglide® A180 bearings at room temperature.

➤ Chemical Table, Page 1.16

Medium	Resistance
Alcohol	+
Hydrocarbons, chlorinated	+
Greases, oils without additives	+
Fuels	+
Weak acids	0 to -
Strong acids	-
Weak alkaline	+
Strong alkaline	+ to 0

+ resistant, 0 conditionally resistant, - not resistant

Table 11.5: Chemical resistance of iglide® A180
All data given concerns the chemical resistance at room temperature (68°F). For a complete list, see page 1.16

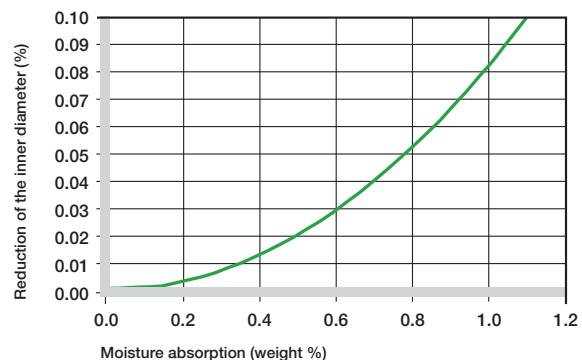

Graph 11.10: Effect of moisture absorption on iglide® A180 plain bearings

iglide® A180

PDF: www.igus.com/iglide-pdfs
CAD: www.igus.com/iglide-CAD
RoHS info: www.igus.com/RoHS

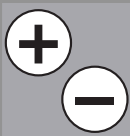



iglide® A180

Telephone 1-800-521-2747
Fax 1-401-438-7270

Internet: <http://www.igus.com>
email: sales@igus.com
QuickSpec: <http://www.igus.com/iglide-quickspec>

Radiation Resistance

Plain bearings made of iglide® A180 are resistant to radiation up to an intensity of $3 \cdot 10^2$ Gy. Higher radiation levels attack the material and can cause the loss of essential mechanical properties.

UV-Resistance

iglide® A180 bearings are resistant to UV radiation, but the tribological properties deteriorate with continuous exposure.

Vacuum

When used in a vacuum environment, the iglidur® A180 plain bearings release moisture as a vapor. Therefore, only dehumidified bearings are suitable in a vacuum environment.

Electrical Properties

iglide® A180 plain bearings are electrically insulating.

iglide® A200

Specific volume resistance $> 10^{12} \Omega\text{cm}$

Surface resistance $> 10^{11} \Omega$

Table 11.6: Electrical properties of iglide® A180

iglide® Plain Bearings A180 - Sleeve, Inch

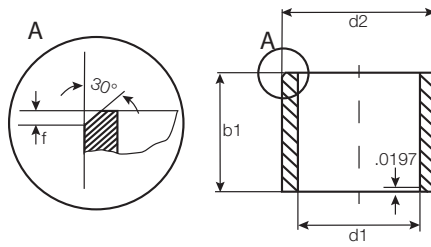

For tolerance values
please refer to page 11.4

iglide® A180
Sleeve - Inch

Part Number	d1	d2	b1	I.D. After Pressfit		Housing Bore		Shaft Size	
				Max.	Min.	Max.	Min.	Max.	Min.
A180SI-0204-04	1/8	1/4	1/4	.1280	.1262	.2515	.2510	.1250	.1241
A180SI-0305-04	3/16	5/16	1/4	.1905	.1887	.3140	.3135	.1875	.1866
A180SI-0406-04	1/4	3/8	1/4	.2539	.2516	.3765	.3760	.2500	.2491
A180SI-0406-06	1/4	3/8	3/8	.2539	.2516	.3765	.3760	.2500	.2491
A180SI-0406-08	1/4	3/8	1/2	.2539	.2516	.3765	.3760	.2500	.2491
A180SI-0507-08	5/16	7/16	1/2	.3164	.3141	.4390	.4385	.3125	.3116
A180SI-0608-04	3/8	1/2	1/4	.3789	.3766	.5015	.5010	.3750	.3741
A180SI-0608-08	3/8	1/2	1/2	.3789	.3766	.5015	.5010	.3750	.3741
A180SI-0810-08	1/2	5/8	1/2	.5047	.5020	.6260	.6250	.5000	.4990
A180SI-0810-12	1/2	5/8	3/4	.5047	.5020	.6260	.6250	.5000	.4990
A180SI-1013-05	5/8	13/16	5/16	.6297	.6270	.8135	.8125	.6250	.6240
A180SI-1013-12	5/8	13/16	3/4	.6297	.6270	.8135	.8125	.6250	.6240
A180SI-1216-12	3/4	1	3/4	.7559	.7525	1.0010	1.0000	.7500	.7490
A180SI-1216-16	3/4	1	1	.7559	.7525	1.0010	1.0000	.7500	.7490
A180SI-1418-16	7/8	1 1/8	1	.8809	.8775	1.1260	1.1250	.8750	.8740
A180SI-1620-12	1	1 1/4	3/4	1.0059	1.0025	1.2510	1.2500	1.0000	.9990
A180SI-1620-16	1	1 1/4	1	1.0059	1.0025	1.2510	1.2500	1.0000	.9990
A180SI-2024-16	1 1/4	1 1/2	1	1.2600	1.2531	1.5005	1.4995	1.2500	1.2490
A180SI-2428-24	1 1/2	1 3/4	1 1/2	1.5100	1.5032	1.7505	1.7495	1.5000	1.4990

PDF: www.igus.com/iglide-pdfs
 CAD: www.igus.com/iglide-CAD
 RoHS info: www.igus.com/RoHS

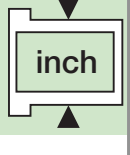

A180



iglide® Plain Bearings A180 - Flange, Inch

iglide® A180
Flange - Inch

Telephone 1-800-521-2747
Fax 1-401-438-7270

Internet: <http://www.igus.com>
email: sales@igus.com
QuickSpec: <http://www.igus.com/iglide-quickspec>

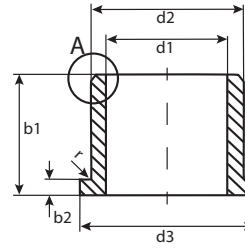
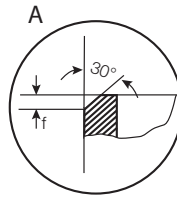

For tolerance values
please refer to page 11.4

r = max. .0197

Part Number	d1	d2	b1	d3	b2	I.D. After Pressfit		Housing Bore		Shaft Size	
						Max.	Min.	Max.	Min.	Max.	Min.
A180FI-0204-04	1/8	1/4	1/4	.360	.047	.1280	.1262	.2515	.2510	.1250	.1241
A180FI-0305-04	3/16	5/16	1/4	.370	.047	.1905	.1887	.3140	.3135	.1875	.1866
A180FI-0406-04	1/4	3/8	1/4	.560	.047	.2539	.2516	.3765	.3760	.2500	.2491
A180FI-0406-06	1/4	3/8	3/8	.560	.047	.2539	.2516	.3765	.3760	.2500	.2491
A180FI-0507-08	5/16	7/16	1/2	.560	.062	.3164	.3141	.4390	.4385	.3125	.3116
A180FI-0608-04	3/8	1/2	1/4	.625	.062	.3787	.3764	.5007	.5000	.3750	.3736
A180FI-0608-08	3/8	1/2	1/2	.625	.062	.3789	.3766	.5015	.5010	.3750	.3741
A180FI-0810-08	1/2	5/8	1/2	.875	.062	.5047	.5020	.6257	.6250	.5000	.4983
A180FI-0810-12	1/2	5/8	3/4	.875	.062	.5047	.5020	.6257	.6250	.5000	.4983
A180FI-1013-16	5/8	13/16	1	1.063	.156	.6297	.6270	.8135	.8125	.6250	.6240
A180FI-1216-12	3/4	1	3/4	1.250	.156	.7559	.7525	1.0010	1.0000	.7500	.7490
A180FI-1216-16	3/4	1	1	1.250	.156	.7559	.7525	1.0010	1.0000	.7500	.7490
A180FI-1418-24	7/8	1 1/8	1 1/2	1.375	.156	.8809	.8775	1.1260	1.1250	.8750	.8740
A180FI-1620-16	1	1 1/4	1	1.500	.188	1.0059	1.0025	1.2510	1.2500	1.0000	.9990
A180FI-1620-24	1	1 1/4	1 1/2	1.500	.188	1.0059	1.0025	1.2510	1.2500	1.0000	.9990
A180FI-2024-16	1 1/4	1 1/2	1	1.750	.200	1.2600	1.2531	1.5005	1.4995	1.2500	1.2490
A180FI-2024-24	1 1/4	1 1/2	1 1/2	1.750	.200	1.2600	1.2531	1.5005	1.4995	1.2500	1.2490
A180FI-2428-16	1 1/2	1 3/4	1	2.000	.125	1.5100	1.5032	1.7505	1.7495	1.5000	1.4990
A180FI-2428-24	1 1/2	1 3/4	1 1/2	2.000	.125	1.5100	1.5032	1.7505	1.7495	1.5000	1.4990
A180FI-2832-16	1 3/4	2	1	2.250	.125	1.7560	1.7532	2.0005	1.9995	1.7500	1.7490

iglide® Plain Bearings A180 - Sleeve, MM

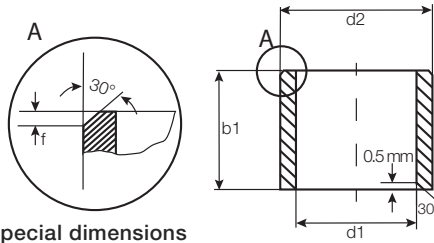

For tolerance values
please refer to page 11.4

Dimensions according to ISO 3547-1 and special dimensions

Part Number	d1	d1-Tolerance After Pressfit in Ø H7	d2	b1 h13	I.D. After Pressfit		Housing Bore		Shaft Size	
					Max.	Min.	Max.	Min.	Max.	Min.
A180SM-0608-10	6.0	+0.020 +0.068	8.0	10.0	6.068	6.020	8.015	8.000	6.000	5.970
A180SM-0810-10	8.0	+0.025 +0.083	10.0	10.0	8.083	8.025	10.015	10.000	8.000	7.964
A180SM-1012-10	10.0	+0.025 +0.083	12.0	10.0	10.083	10.025	12.018	12.000	10.000	9.964
A180SM-1214-15	12.0	+0.032 +0.102	14.0	15.0	12.102	12.032	14.018	14.000	12.000	11.957
A180SM-1618-15	16.0	+0.032 +0.102	18.0	15.0	16.102	16.032	18.018	18.000	16.000	15.957
A180SM-2023-20	20.0	+0.040 +0.124	23.0	20.0	20.124	20.040	23.021	23.000	20.000	19.948
A180SM-2528-30	25.0	+0.040 +0.124	28.0	20.0	25.124	25.040	28.021	28.000	25.000	24.948
A180SM-3034-20	30.0	+0.040 +0.124	34.0	20.0	30.124	30.040	34.025	34.000	30.000	29.948

iglide® Plain Bearings A180 - Flange, MM

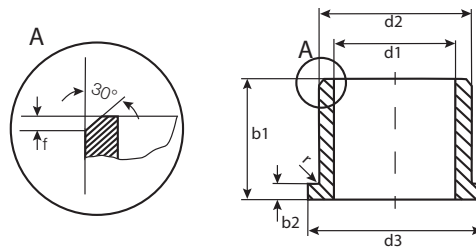

For tolerance values
please refer to page 11.4

r = max. 0.5

Dimensions according to ISO 3547-1 and special dimensions

Part Number	d1 ¹⁾	d1-Tolerance After Pressfit in Ø H7	d2	d3 d13	b1 h13	b2 -0,14	I.D. After Pressfit		Housing Bore		Shaft Size	
							Max.	Min.	Max.	Min.	Max.	Min.
A180FM-0608-06	6.0	+0.020 +0.068	8.0	12.0	6.0	1.0	6.068	6.020	8.015	8.000	6.000	5.970
A180FM-0810-10	8.0	+0.025 +0.083	10.0	15.0	10.0	1.0	8.083	8.025	10.015	10.000	10.000	9.964
A180FM-1012-10	10.0	+0.025 +0.083	12.0	18.0	10.0	1.0	10.083	10.025	12.018	12.000	10.000	9.964
A180FM-1214-15	12.0	+0.032 +0.102	14.0	20.0	15.0	1.0	12.102	12.032	14.018	14.000	15.000	14.957
A180FM-1618-17	16.0	+0.032 +0.102	18.0	24.0	17.0	1.0	16.102	16.032	18.018	18.000	17.000	16.957
A180FM-2023-21	20.0	+0.040 +0.124	23.0	30.0	21.5	1.5	20.124	20.040	23.021	23.000	21.000	20.948
A180FM-2528-21	25.0	+0.040 +0.124	28.0	35.0	21.5	1.5	25.124	25.040	28.021	28.000	21.000	20.948
A180FM-3034-26	30.0	+0.040 +0.124	34.0	42.0	26.0	2.0	30.124	30.040	34.025	34.000	26.000	25.948

iglide® A180
Sleeve - MM

PDF: www.igus.com/iglide-pdfs
CAD: www.igus.com/iglide-CAD
RoHS info: www.igus.com/RoHS

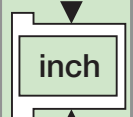
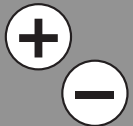



iglide® Plain Bearings A180 - Notes

iglide® A180

Telephone 1-800-521-2747
Fax 1-401-438-7270

Internet: <http://www.igus.com>
email: sales@igus.com
QuickSpec: <http://www.igus.com/iglide-quickspec>

igus[®]



iglide[®] A200

Product Range

- Standard Styles:
Sleeve, Flange and Thrust Washer
- Custom shapes and sizes available
- Inner diameters:
Inch sizes from 1/8 - 1-3/4 in.
Metric sizes from 1 - 32 mm

Part Number Structure

Part Number Structure

A S I-02 04-04

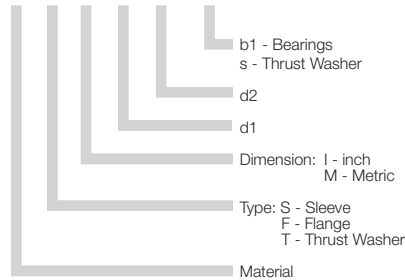

Permissible Surface Speeds

	Continuous fpm	Short Term fpm
Rotating	157	295
Oscillating	118	216
Linear	393	590

Usage Guidelines



- When your bearing comes in direct contact with food or pharmaceuticals
- For low speeds
- When quiet operation is important
- When dirt needs to become embedded



- When the maximum abrasion resistance is necessary
➤ iglide® L280
- When temperatures are continuously greater than 176°F
➤ iglide® A290, T500
- When a cost-effective universal bearing is desired
➤ iglide® G300



Visit www.igus.com to use our online expert system

Material Data

General Properties	Unit	iglide® A200	Testing Method
Density	g/cm ³	1.14	
Color		white	
Max. moisture absorption at 73°F / 50% r.h.	% weight	1.5	DIN 53495
Max. moisture absorption	% weight	7.6	
Coefficient of friction, dynamic against steel	μ	0.10 - 0.40	
p x v value, max. (dry)	psi x fpm	2900	

Mechanical Properties

Modulus of elasticity	psi	362,500	DIN 53457
Tensile strength 68°F	psi	16,820	DIN 53452
Compressive strength	psi	7,830	
Permissible static surface pressure (68°F)	psi	2,610	
Shore D-hardness		81	DIN 53505

Physical and Thermal Properties

Max. long-term application temperature	°F	146	
Max. short-term application temperature	°F	338	
Min. application temperature	°F	-40	
Thermal conductivity	[W/m x K]	0.24	ASTM C 177
Coefficient of thermal expansion (at 73°F)	[K ⁻¹ x 10 ⁻⁵]	10	DIN 53752

Electrical Properties

Specific volume resistance	Ωcm	> 10 ¹³	DIN IEC 93
Surface resistance	Ω	> 10 ¹²	DIN 53482

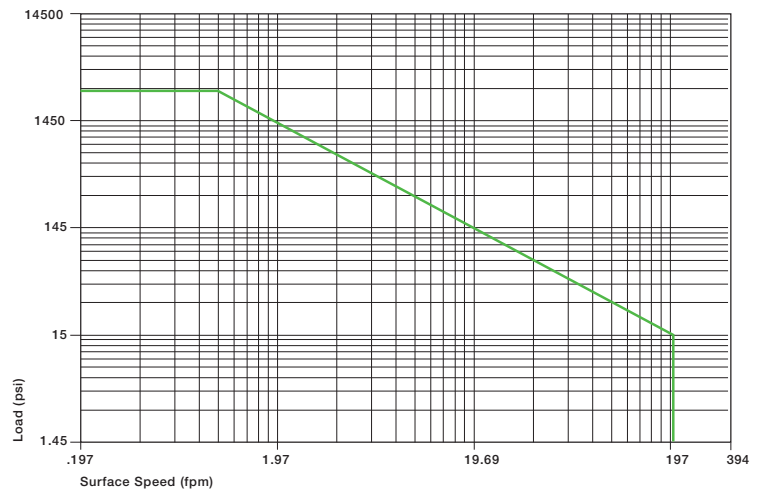

Graph 12.1: Permissible p x v values for iglide® A200 running dry against a steel shaft, at 68°F



iglide® A200 is FDA compliant

Plain bearings made of iglide® A200 are FDA approved for use in direct contact with food and pharmaceuticals. They are an ideal solution for bearing applications on machines that manufacture consumables, pharmaceuticals, medical devices, small household appliances, etc. To achieve the benefit of food compatibility, mixing with solid lubricants must be avoided. The thermoplastic alloy of iglide® A200 is used for abrasion resistance. Furthermore, iglide® A200 is characterized by its capacity for embedding dirt and by its quiet running behavior.

Compressive Strength

The high abrasion resistance, the resistance to dirt, and the ability to run dry make it possible to eliminate the customary, expensive protective coverings of lubricated bearings.

Graph 12.2 shows the elastic deformation of iglide® A200 for radial loads. At the maximum permissible static surface pressure of 2610 psi, the deformation is less than 2%.

Plastic deformation is minimal up to this radial load. However, it is also a result of the cycle time.

➤ Compressive Strength, Page 1.3

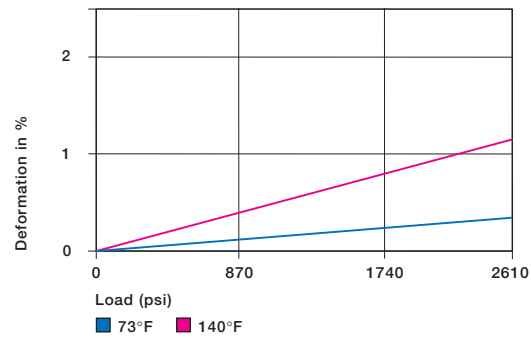

Graph 12.2: Deformation under load and temperature

Permissible Surface Speeds

iglide® A200 was developed for low surface speeds. Running dry for continuous usage, a maximum of 157 fpm (rotating) or 393 fpm (linear) is possible.

These given values indicate the limits at which an increase up to the continuous permissible temperature occurs. This increase is a result of friction. In practice these limit values are not often reached, due to varying application conditions.

➤ Surface Speed, Page 1.5

➤ $p \times v$ value, Page 1.6

	Continuous fpm	Short Term fpm
Rotating	157	295
Oscillating	118	216
Linear	393	590

Table 12.2: Maximum surface speeds

Temperatures

The maximum permissible short-term temperature is 338°F. With increasing temperatures, the compressive strength of iglide® A200 plain bearings decreases. Graph 12.3 shows this relationship. The ambient temperatures prevalent in the bearing system also have an effect on the bearing wear.

➤ Application Temperatures, Page 1.7

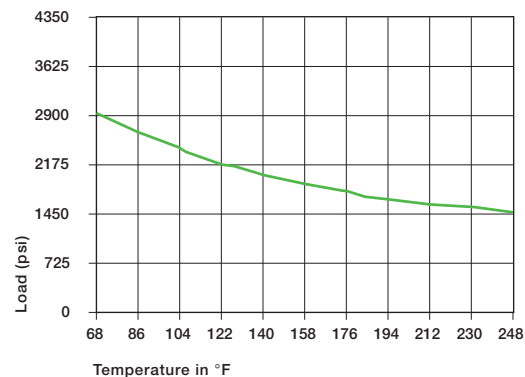

Graph 12.3: Recommended maximum permissible static surface pressure of iglide® A200 as a result of the temperature

iglide® A200	Application Temperature
Minimum	-40°F
Max. long-term	+176°F
Max. short-term	+338°F

Table 12.3: Temperature iglide® A200

PDF: www.igus.com/iglide-pdfs
 CAD: www.igus.com/iglide-CAD
 RoHS info: www.igus.com/RoHS

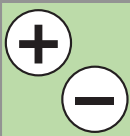

Installation Tolerances

iglide® A200 plain bearings are meant to be oversized before being pressfit. After proper installation into a recommended housing bore, the inner diameter adjusts to meet our specified tolerances. Please adhere to the catalog specifications for housing bore and recommended shaft sizes. This will help to ensure optimal performance of iglide® plain bearings.

- ▶ See Tolerance Table, Page 1.14
- ▶ Testing Methods, Page 1.15

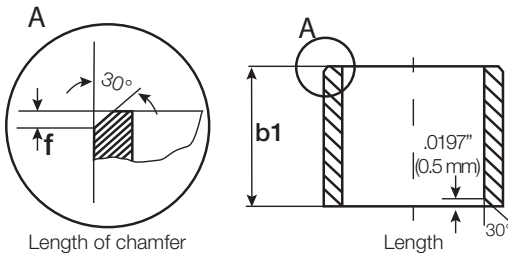

For Inch Size Bearings		
Length Tolerance (b1)		Length of Chamfer (f)
Length (inches)	Tolerance (h13) (inches)	Based on d1
0.1181 to 0.2362	-0.0000 /-0.0071	f = .012 → d ₁ .040" - .236"
0.2362 to 0.3937	-0.0000 /-0.0087	f = .019 → d ₁ > .236" - .472"
0.3937 to 0.7086	-0.0000 /-0.0106	f = .031 → d ₁ > .472" - 1.18"
0.7086 to 1.1811	-0.0000 /-0.0130	f = .047 → d ₁ > 1.18"
1.1811 to 1.9685	-0.0000 /-0.0154	
1.9685 to 3.1496	-0.0000 /-0.0181	

For Metric Size Bearings		
Length Tolerance (b1)		Length of Chamfer (f)
Length (mm)	Tolerance (h13) (µm)	Based on d1
1 to 3	-0 /-140	f = 0.3 → d ₁ 1 - 6 mm
>3 to 6	-0 /-180	f = 0.5 → d ₁ > 6 - 12 mm
>6 to 10	-0 /-220	f = 0.8 → d ₁ > 12 - 30 mm
>10 to 18	-0 /-270	f = 1.2 → d ₁ > 30 mm
>18 to 30	-0 /-330	
>30 to 50	-0 /-390	
>50 to 80	-0 /-460	

Friction and Wear

Similar to wear resistance, the coefficient of friction also changes with the load. For iglide® A200 plain bearings, the coefficient of friction μ decreases slightly with increasing load. Friction and wear are also dependent to a large degree on the shafting partner. Shafts that are too smooth not only increase the coefficient of friction, they can also increase the wear of the bearing. For iglide® A200 a ground surface with an average roughness range of 16-24 rms is recommended for the shaft.

- ▶ Coefficients of Friction and Surfaces, Page 1.8
- ▶ Wear Resistance, Page 1.9

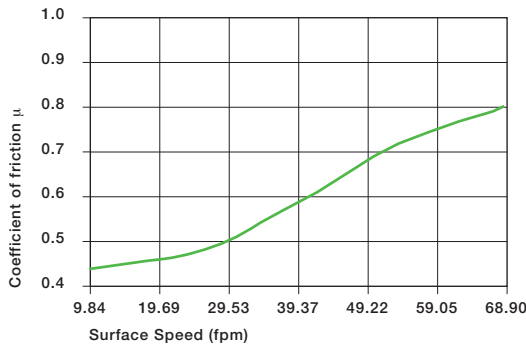

Graph 12.4: Coefficients of friction of iglide® A200 as a function of the running speed; p = 108 psi

iglide® A200	Coefficient of Friction
Dry	0.10 - 0.40
Grease	0.09
Oil	0.04
Water	0.04

Table 12.4: Coefficient of friction of iglide® A200 against steel (Shaft finish = 1 µm, 50 HRC)

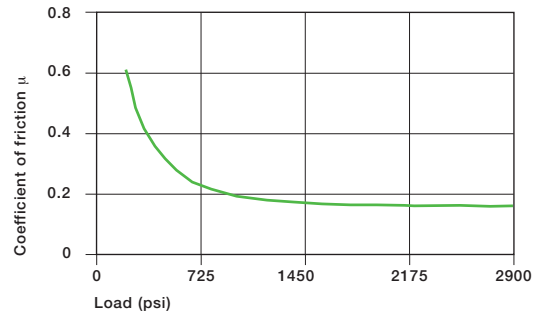

Graph 12.5: Coefficients of friction of iglide® A200 as a function of the load, v = 0.01 m/s

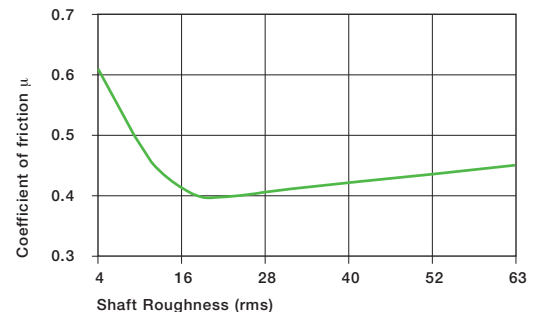

Graph 12.6: Coefficients of friction of iglide® A200 as a function of the shaft surface (shaft Cold Rolled Steel)

Shaft Materials

Graph 12.7 and 12.9 show results of testing different shaft materials with plain bearings made of iglide® A200.

➤ Shaft Materials, Page 1.11

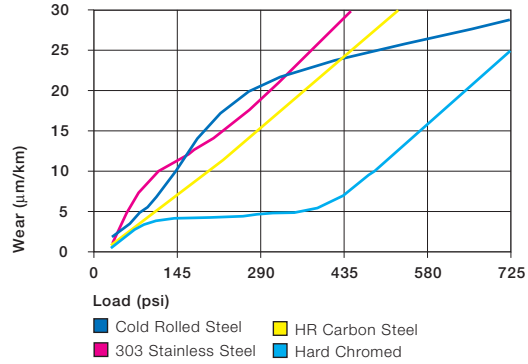

Graph 12.8: Wear of iglide® A200 with different shaft materials in rotational applications

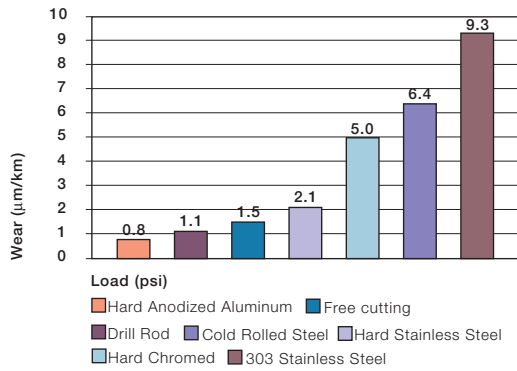

Graph 12.7: Wear of iglide® A200, rotating applications with different shaft materials, p=108 psi, v=98 fpm

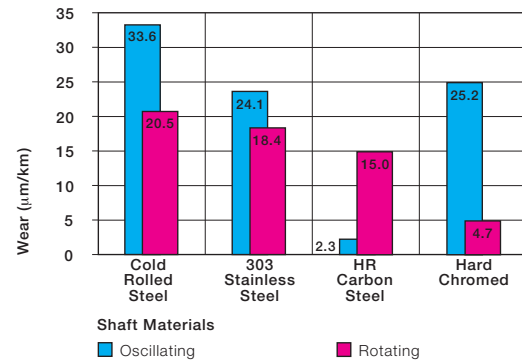

Graph 12.9: Wear with different shaft materials, oscillating and rotating movement p = 290 psi

Chemical Resistance

iglide® A200 plain bearings have strong resistance to chemicals. They are also resistant to most lubricants.

iglide® A200 plain bearings are not attacked by most weak organic and inorganic acids.

The moisture absorption of iglide® A200 plain bearings is approximately 1.5% in the standard atmosphere. The saturation limit submerged in water is 7.6%. This must be taken into account for these types of use applications.

➤ Chemical Table, Page 1.16

Medium	Resistance
Alcohol	+ to 0
Hydrocarbons, chlorinated	+
Greases, oils without additives	+
Fuels	+
Weak acids	0 to -
Strong acids	-
Weak alkaline	+
Strong alkaline	0

+ resistant, 0 conditionally resistant, - not resistant

Table 12.5: Chemical resistance of iglide® A200
All data given concerns the chemical resistance at room temperature (68°F). For a complete list, see page 1.16

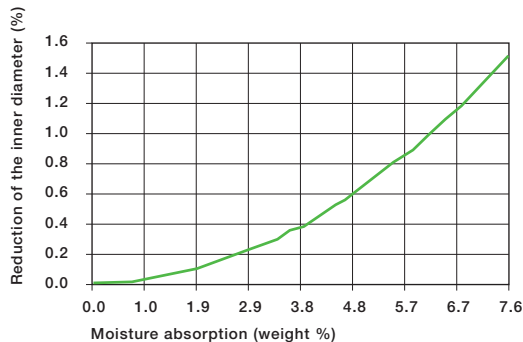

Graph 12.10: Effect of moisture absorption on iglide® A200 plain bearings

Radiation Resistance

Plain bearings made from iglide® A200 are resistant to radiation up to an intensity of 2×10^4 Gy. Higher radiation levels attack the material and can cause essential mechanical properties to be lost.

UV-Resistance

iglide® A200 plain bearings are resistant to UV radiation.

Vacuum

In a vacuum environment, iglide® A200 plain bearings have restricted use.

Electrical Properties

iglide® A200 plain bearings are electrically insulating.

iglide® A200

Specific volume resistance	> $10^{13} \Omega\text{cm}$
Surface resistance	> $10^{12} \Omega$

Table 12.6: Electrical properties of iglide® A200

iglide® Plain Bearings A200 - Sleeve, Inch

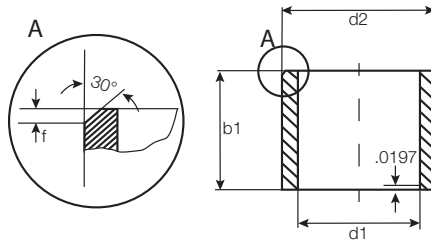

For tolerance values
please refer to page 12.4

iglide® A200
Sleeve - Inch

Part Number	d1	d2	b1	I.D. After Pressfit		Housing Bore		Shaft Size	
				Max.	Min.	Max.	Min.	Max.	Min.
ASI-0204-04	1/8	1/4	1/4	.1280	.1262	.2515	.2510	.1250	.1241
ASI-0305-04	3/16	5/16	1/4	.1905	.1887	.3140	.3135	.1875	.1866
ASI-0406-04	1/4	3/8	1/4	.2539	.2516	.3765	.3760	.2500	.2491
ASI-0406-06	1/4	3/8	3/8	.2539	.2516	.3765	.3760	.2500	.2491
ASI-0406-08	1/4	3/8	1/2	.2539	.2516	.3765	.3760	.2500	.2491
ASI-0507-08	5/16	7/16	1/2	.3164	.3141	.4390	.4385	.3125	.3116
ASI-0608-04	3/8	1/2	1/4	.3789	.3766	.5015	.5010	.3750	.3741
ASI-0608-08	3/8	1/2	1/2	.3789	.3766	.5015	.5010	.3750	.3741
ASI-0810-08	1/2	5/8	1/2	.5047	.5020	.6260	.6250	.5000	.4990
ASI-0810-12	1/2	5/8	3/4	.5047	.5020	.6260	.6250	.5000	.4990
ASI-1013-05	5/8	13/16	5/16	.6297	.6270	.8135	.8125	.6250	.6240
ASI-1013-12	5/8	13/16	3/4	.6297	.6270	.8135	.8125	.6250	.6240
ASI-1216-12	3/4	1	3/4	.7559	.7525	1.0010	1.0000	.7500	.7490
ASI-1216-16	3/4	1	1	.7559	.7525	1.0010	1.0000	.7500	.7490
ASI-1418-16	7/8	1 1/8	1	.8809	.8775	1.1260	1.1250	.8750	.8740
ASI-1620-12	1	1 1/4	3/4	1.0059	1.0025	1.2510	1.2500	1.0000	.9990
ASI-1620-16	1	1 1/4	1	1.0059	1.0025	1.2510	1.2500	1.0000	.9990
ASI-2024-16	1 1/4	1 1/2	1	1.2600	1.2531	1.5005	1.4995	1.2500	1.2490
ASI-2428-24	1 1/2	1 3/4	1 1/2	1.5100	1.5032	1.7505	1.7495	1.5000	1.4990

PDF: www.igus.com/iglide-pdfs
CAD: www.igus.com/iglide-CAD
RoHS info: www.igus.com/RoHS

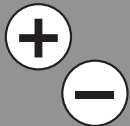

A200



iglide® Plain Bearings A200 - Flange, Inch

iglide® A200
Flange - Inch
Thrust Washer - Inch

Telephone 1-800-521-2747
Fax 1-401-438-7270

Internet: <http://www.igus.com>
email: sales@igus.com
QuickSpec: <http://www.igus.com/iglide-quickspec>

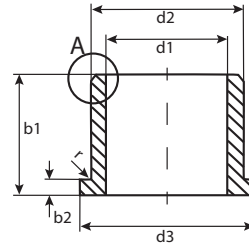
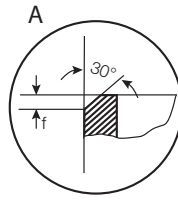

For tolerance values
please refer to page 12.4

r = max. .0197

Part Number	d1	d2	b1	d3	b2	I.D. After Pressfit		Housing Bore		Shaft Size	
						Max.	Min.	Max.	Min.	Max.	Min.
AFI-0204-04	1/8	1/4	1/4	.360	.047	.1280	.1262	.2515	.2510	.1250	.1241
AFI-0305-04	3/16	5/16	1/4	.370	.047	.1905	.1887	.3140	.3135	.1875	.1866
AFI-0406-04	1/4	3/8	1/4	.560	.047	.2539	.2516	.3765	.3760	.2500	.2491
AFI-0406-06	1/4	3/8	3/8	.560	.047	.2539	.2516	.3765	.3760	.2500	.2491
AFI-0507-08	5/16	7/16	1/2	.560	.062	.3164	.3141	.4390	.4385	.3125	.3116
AFI-0608-04	3/8	1/2	1/4	.625	.062	.3787	.3764	.5007	.5000	.3750	.3736
AFI-0608-08	3/8	1/2	1/2	.625	.062	.3789	.3766	.5015	.5010	.3750	.3741
AFI-0810-08	1/2	5/8	1/2	.875	.062	.5047	.5020	.6257	.6250	.5000	.4983
AFI-0810-12	1/2	5/8	3/4	.875	.062	.5047	.5020	.6257	.6250	.5000	.4983
AFI-1013-16	5/8	13/16	1	1.063	.156	.6297	.6270	.8135	.8125	.6250	.6240
AFI-1216-12	3/4	1	3/4	1.250	.156	.7559	.7525	1.0010	1.0000	.7500	.7490
AFI-1216-16	3/4	1	1	1.250	.156	.7559	.7525	1.0010	1.0000	.7500	.7490
AFI-1418-24	7/8	1 1/8	1 1/2	1.375	.156	.8809	.8775	1.1260	1.1250	.8750	.8740
AFI-1620-16	1	1 1/4	1	1.500	.188	1.0059	1.0025	1.2510	1.2500	1.0000	.9990
AFI-1620-24	1	1 1/4	1 1/2	1.500	.188	1.0059	1.0025	1.2510	1.2500	1.0000	.9990
AFI-2024-16	1 1/4	1 1/2	1	1.750	.200	1.2600	1.2531	1.5005	1.4995	1.2500	1.2490
AFI-2024-24	1 1/4	1 1/2	1 1/2	1.750	.200	1.2600	1.2531	1.5005	1.4995	1.2500	1.2490
AFI-2428-16	1 1/2	1 3/4	1	2.000	.125	1.5100	1.5032	1.7505	1.7495	1.5000	1.4990
AFI-2428-24	1 1/2	1 3/4	1 1/2	2.000	.125	1.5100	1.5032	1.7505	1.7495	1.5000	1.4990
AFI-2832-16	1 3/4	2	1	2.250	.125	1.7560	1.7532	2.0005	1.9995	1.7500	1.7490

iglide® A200 - Linear Plain Bearing Thrust Washer, Inch

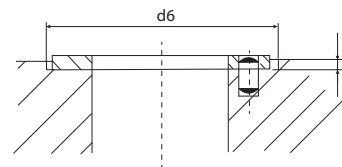
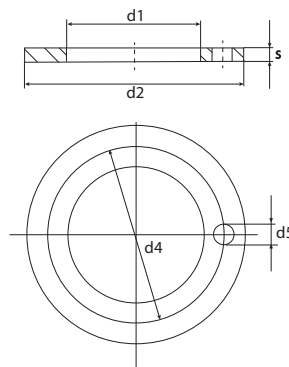

Part Number	d1	d1		d2		s
	(nominal)	Max.	Min.	Max	Min.	-0.0056
ATI-04	1/4	.2610	.2551	.6201	.6094	.0902
ATI-06	3/8	.3943	.3813	.7500	.7370	.0902
ATI-08	1/2	.5102	.5031	.8201	.8071	.0902
ATI-12	3/4	.7673	.7598	1.0654	1.0500	.0941
ATI-16	1	1.0268	1.0197	1.5000	1.4843	.1252

iglide® Plain Bearings A200 - Sleeve, MM

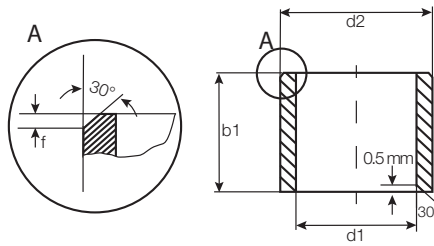

For tolerance values
please refer to page 12.4

Dimensions according to ISO 3547-1 and special dimensions

Part Number	d1		d2	b1	I.D. After Pressfit		Housing Bore		Shaft Size	
	After Pressfit in Ø H7				h13	Max.	Min.	Max.	Min.	Max.
ASM-0103-02	1.0	+0.020 +0.080	3.0	2.0	1.080	1.020	3.080	3.000	1.000	.975
ASM-0104-02	1.5	+0.020 +0.080	4.0	2.0	1.580	1.520	4.012	4.000	1.500	1.475
ASM-0205-02	2.0	+0.020 +0.080	5.0	2.0	2.080	2.020	5.012	5.000	2.000	1.975
ASM-0205-03	2.0	+0.020 +0.080	5.0	3.0	2.080	2.020	5.012	5.000	2.000	1.975
ASM-0206-03	2.5	+0.020 +0.080	6.0	3.0	2.580	2.520	6.012	6.000	2.500	2.475
ASM-0305-03	3.0	+0.020 +0.080	5.0	3.0	3.080	3.020	5.012	5.000	3.000	2.975
ASM-0305-04	3.0	+0.020 +0.080	5.0	4.0	3.080	3.020	5.012	5.000	3.000	2.975
ASM-0306-03	3.0	+0.020 +0.080	6.0	3.0	3.080	3.020	6.012	6.000	3.000	2.975
ASM-0306-04	3.0	+0.020 +0.080	6.0	4.0	3.080	3.020	6.012	6.000	3.000	2.975
ASM-0407-03	4.0	+0.030 +0.105	7.0	3.0	4.105	4.030	7.015	7.000	4.000	3.970
ASM-0407-04	4.0	+0.030 +0.105	7.0	4.0	4.105	4.030	7.015	7.000	4.000	3.970
ASM-0407-06	4.0	+0.030 +0.105	7.0	6.0	4.105	4.030	7.015	7.000	4.000	3.970
ASM-0408-06	4.0	+0.030 +0.105	8.0	6.0	4.105	4.030	8.015	8.000	4.000	3.970
ASM-0508-04	5.0	+0.030 +0.105	8.0	4.0	5.105	5.030	8.015	8.000	5.000	4.970
ASM-0508-05	5.0	+0.030 +0.105	8.0	5.0	5.105	5.030	8.015	8.000	5.000	4.970
ASM-0508-08	5.0	+0.030 +0.105	8.0	8.0	5.105	5.030	8.015	8.000	5.000	4.970
ASM-0509-05	5.0	+0.030 +0.105	9.0	5.0	5.105	5.030	9.015	9.000	5.000	4.970
ASM-0509-08	5.0	+0.030 +0.105	9.0	8.0	5.105	5.030	9.015	9.000	5.000	4.970
ASM-0608-10	6.0	+0.030 +0.105	8.0	10.0	6.105	6.030	8.015	8.000	6.000	5.970
ASM-0609-06	6.0	+0.030 +0.105	9.0	6.0	6.105	6.030	9.015	9.000	6.000	5.970
ASM-0610-04	6.0	+0.030 +0.105	10.0	4.0	6.105	6.030	10.015	10.000	6.000	5.970
ASM-0610-06	6.0	+0.030 +0.105	10.0	6.0	6.105	6.030	10.015	10.000	6.000	5.970
ASM-0610-10	6.0	+0.030 +0.105	10.0	10.0	6.105	6.030	10.015	10.000	6.000	5.970
ASM-0612-06	6.0	+0.030 +0.105	12.0	6.0	6.105	6.030	12.018	12.000	6.000	5.970
ASM-0612-10	6.0	+0.030 +0.105	12.0	10.0	6.105	6.030	12.018	12.000	6.000	5.970
ASM-0710-05	7.0	+0.040 +0.130	10.0	5.0	7.130	7.030	10.015	10.000	7.000	6.964
ASM-0710-08	7.0	+0.040 +0.130	10.0	8.0	7.130	7.030	10.015	10.000	7.000	6.964
ASM-0810-06	8.0	+0.040 +0.130	10.0	6.0	8.130	8.040	10.015	10.000	8.000	7.964
ASM-0810-08	8.0	+0.040 +0.130	10.0	8.0	8.130	8.040	10.015	10.000	8.000	7.964
ASM-0810-10	8.0	+0.040 +0.130	10.0	10.0	8.130	8.040	10.015	10.000	8.000	7.964
ASM-0811-08	8.0	+0.040 +0.130	11.0	8.0	8.130	8.040	11.018	11.000	8.000	7.964
ASM-0811-12	8.0	+0.040 +0.130	11.0	12.0	8.130	8.040	11.018	11.000	8.000	7.964
ASM-0812-06	8.0	+0.040 +0.130	12.0	6.0	8.130	8.040	12.018	12.000	8.000	7.964
ASM-0812-08	8.0	+0.040 +0.130	12.0	8.0	8.130	8.040	12.018	12.000	8.000	7.964
ASM-0812-10	8.0	+0.040 +0.130	12.0	10.0	8.130	8.040	12.018	12.000	8.000	7.964
ASM-0812-12	8.0	+0.040 +0.130	12.0	12.0	8.130	8.040	12.018	12.000	8.000	7.964
ASM-0814-06	8.0	+0.040 +0.130	14.0	6.0	8.130	8.040	14.018	14.000	8.000	7.964
ASM-0814-10	8.0	+0.040 +0.130	14.0	10.0	8.130	8.040	14.018	14.000	8.000	7.964
ASM-0912-14	9.0	+0.040 +0.130	12.0	14.0	9.130	9.040	12.018	12.000	9.000	8.964
ASM-1012-10	10.0	+0.040 +0.130	12.0	10.0	10.130	10.040	12.018	12.000	10.000	9.964
ASM-1014-06	10.0	+0.040 +0.130	14.0	6.0	10.130	10.040	14.018	14.000	10.000	9.964

iglide® A200
Sleeve - MM

PDF: www.igus.com/iglide-pdfs
CAD: www.igus.com/iglide-CAD
RoHS info: www.igus.com/RoHS

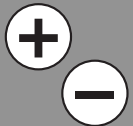

A200



iglide® Plain Bearings A200 - Sleeve, MM

iglide® A200
Sleeve - MM

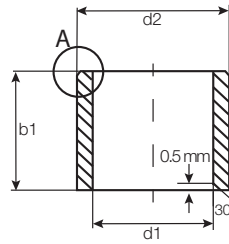
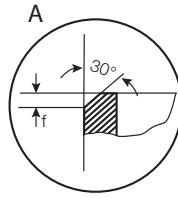

For tolerance values
please refer to page 12.4

Dimensions according to ISO 3547-1 and special dimensions

Part Number	d1		d2	b1 h13	I.D. After Pressfit		Housing Bore		Shaft Size	
	After Pressfit in Ø H7				Max.	Min.	Max.	Min.	Max.	Min.
ASM-1014-08	10.0	+0.040 +0.130	14.0	8.0	10.130	10.040	14.018	14.000	10.000	9.964
ASM-1014-10	10.0	+0.040 +0.130	14.0	10.0	10.130	10.040	14.018	14.000	10.000	9.964
ASM-1014-16	10.0	+0.040 +0.130	14.0	16.0	10.130	10.040	14.018	14.000	10.000	9.964
ASM-1016-06	10.0	+0.040 +0.130	16.0	6.0	10.130	10.040	16.018	16.000	10.000	9.964
ASM-1016-10	10.0	+0.040 +0.130	16.0	10.0	10.130	10.040	16.018	16.000	10.000	9.964
ASM-1016-16	10.0	+0.040 +0.130	16.0	16.0	10.130	10.040	16.018	16.000	10.000	9.964
ASM-1214-20	12.0	+0.050 +0.160	14.0	20.0	12.160	12.050	14.018	14.000	12.000	11.957
ASM-1216-15	12.0	+0.050 +0.160	16.0	15.0	12.160	12.050	16.018	16.000	12.000	11.957
ASM-1216-20	12.0	+0.050 +0.160	16.0	20.0	12.160	12.050	16.018	16.000	12.000	11.957
ASM-1218-08	12.0	+0.050 +0.160	18.0	8.0	12.160	12.050	18.018	18.000	12.000	11.957
ASM-1218-10	12.0	+0.050 +0.160	18.0	10.0	12.160	12.050	18.018	18.000	12.000	11.957
ASM-1218-15	12.0	+0.050 +0.160	18.0	15.0	12.160	12.050	18.018	18.000	12.000	11.957
ASM-1218-20	12.0	+0.050 +0.160	18.0	20.0	12.160	12.050	18.018	18.000	12.000	11.957
ASM-1416-10	14.0	+0.050 +0.160	16.0	10.0	14.160	14.050	16.018	16.000	14.000	13.957
ASM-1416-15	14.0	+0.050 +0.160	16.0	15.0	14.160	14.050	16.018	16.000	14.000	13.957
ASM-1416-20	14.0	+0.050 +0.160	16.0	20.0	14.160	14.050	16.018	16.000	14.000	13.957
ASM-1420-10	14.0	+0.050 +0.160	20.0	10.0	14.160	14.050	20.021	20.000	14.000	13.957
ASM-1420-15	14.0	+0.050 +0.160	20.0	15.0	14.160	14.050	20.021	20.000	14.000	13.957
ASM-1420-20	14.0	+0.050 +0.160	20.0	20.0	14.160	14.050	20.021	20.000	14.000	13.957
ASM-1517-10	15.0	+0.050 +0.160	17.0	10.0	15.160	15.050	17.018	17.000	15.000	14.957
ASM-1517-15	15.0	+0.050 +0.160	17.0	15.0	15.160	15.050	17.018	17.000	15.000	14.957
ASM-1521-10	15.0	+0.050 +0.160	21.0	10.0	15.160	15.050	21.021	21.000	15.000	14.957
ASM-1521-15	15.0	+0.050 +0.160	21.0	15.0	15.160	15.050	21.021	21.000	15.000	14.957
ASM-1521-20	15.0	+0.050 +0.160	21.0	20.0	15.160	15.050	21.021	21.000	15.000	14.957
ASM-1618-12	16.0	+0.050 +0.160	18.0	12.0	16.160	16.050	18.018	18.000	16.000	15.957
ASM-1618-20	16.0	+0.050 +0.160	18.0	20.0	16.160	16.050	18.018	18.000	16.000	15.957
ASM-1620-20	16.0	+0.050 +0.160	20.0	20.0	16.160	16.050	20.021	20.000	16.000	15.957
ASM-1620-25	16.0	+0.050 +0.160	20.0	25.0	16.160	16.050	20.021	20.000	16.000	15.957
ASM-1622-12	16.0	+0.050 +0.160	22.0	12.0	16.160	16.050	22.021	22.000	16.000	15.957
ASM-1622-15	16.0	+0.050 +0.160	22.0	15.0	16.160	16.050	22.021	22.000	16.000	15.957
ASM-1622-16	16.0	+0.050 +0.160	22.0	16.0	16.160	16.050	22.021	22.000	16.000	15.957
ASM-1622-20	16.0	+0.050 +0.160	22.0	20.0	16.160	16.050	22.021	22.000	16.000	15.957
ASM-1622-25	16.0	+0.050 +0.160	22.0	25.0	16.160	16.050	22.021	22.000	16.000	15.957
ASM-1824-12	18.0	+0.050 +0.160	24.0	12.0	18.160	18.050	24.021	24.000	18.000	17.957
ASM-1824-20	18.0	+0.050 +0.160	24.0	20.0	18.160	18.050	24.021	24.000	18.000	17.957
ASM-1824-30	18.0	+0.050 +0.160	24.0	30.0	18.160	18.050	24.021	24.000	18.000	17.957
ASM-2023-15	20.0	+0.065 +0.195	23.0	15.0	20.195	20.065	23.021	23.000	20.000	19.948
ASM-2023-20	20.0	+0.065 +0.195	23.0	20.0	20.195	20.065	23.021	23.000	20.000	19.948
ASM-2025-15	20.0	+0.065 +0.195	25.0	15.0	20.195	20.065	25.021	25.000	20.000	19.948
ASM-2025-20	20.0	+0.065 +0.195	25.0	20.0	20.195	20.065	25.021	25.000	20.000	19.948
ASM-2025-30	20.0	+0.065 +0.195	25.0	30.0	20.195	20.065	25.021	25.000	20.000	19.948

Telephone 1-800-521-2747
Fax 1-401-438-7270

Internet: <http://www.igus.com>
email: sales@igus.com
QuickSpec: <http://www.igus.com/iglide-quickspec>

iglide® Plain Bearings A200 - Sleeve, MM

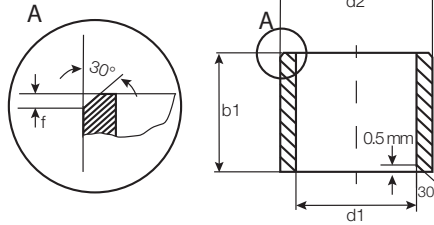

For tolerance values
please refer to page 12.4

Dimensions according to ISO 3547-1 and special dimensions

Part Number	d1	d1-Tolerance After Pressfit in Ø H7	d2	b1 h13	I.D. After Pressfit		Housing Bore		Shaft Size	
					Max.	Min.	Max.	Min.	Max.	Min.
ASM-2026-15	20.0	+0.065 +0.195	26.0	15.0	20.195	20.065	26.021	26.000	20.000	19.948
ASM-2026-20	20.0	+0.065 +0.195	26.0	20.0	20.195	20.065	26.021	26.000	20.000	19.948
ASM-2026-30	20.0	+0.065 +0.195	26.0	30.0	20.195	20.065	26.021	26.000	20.000	19.948
ASM-2226-15	22.0	+0.065 +0.195	26.0	15.0	22.195	22.065	26.021	26.000	22.000	21.948
ASM-2228-10	22.0	+0.065 +0.195	28.0	10.0	22.195	22.065	28.021	28.000	22.000	21.948
ASM-2228-15	22.0	+0.065 +0.195	28.0	15.0	22.195	22.065	28.021	28.000	22.000	21.948
ASM-2228-20	22.0	+0.065 +0.195	28.0	20.0	22.195	22.065	28.021	28.000	22.000	21.948
ASM-2228-30	22.0	+0.065 +0.195	28.0	30.0	22.195	22.065	28.021	28.000	22.000	21.948
ASM-2430-15	24.0	+0.065 +0.195	30.0	15.0	24.195	24.065	30.025	30.000	24.000	23.948
ASM-2430-20	24.0	+0.065 +0.195	30.0	20.0	24.195	24.065	30.025	30.000	24.000	23.948
ASM-2430-30	24.0	+0.065 +0.195	30.0	30.0	24.195	24.065	30.025	30.000	24.000	23.948
ASM-2528-12	25.0	+0.065 +0.195	28.0	12.0	25.195	25.065	28.021	28.000	25.000	24.948
ASM-2528-20	25.0	+0.065 +0.195	28.0	20.0	25.195	25.065	28.021	28.000	25.000	24.948
ASM-2530-20	25.0	+0.065 +0.195	30.0	20.0	25.195	25.065	30.025	30.000	25.000	24.948
ASM-2530-30	25.0	+0.065 +0.195	30.0	30.0	25.195	25.065	30.025	30.000	25.000	24.948
ASM-2530-40	25.0	+0.065 +0.195	30.0	40.0	25.195	25.065	30.025	30.000	25.000	24.948
ASM-2532-20	25.0	+0.065 +0.195	32.0	20.0	25.195	25.065	32.025	32.000	25.000	24.948
ASM-2532-30	25.0	+0.065 +0.195	32.0	30.0	25.195	25.065	32.025	32.000	25.000	24.948
ASM-2532-40	25.0	+0.065 +0.195	32.0	40.0	25.195	25.065	32.025	32.000	25.000	24.948
ASM-2630-20	26.0	+0.065 +0.195	30.0	20.0	26.195	26.065	30.025	30.000	26.000	25.948
ASM-2632-30	26.0	+0.065 +0.195	32.0	30.0	26.195	26.065	32.025	32.000	26.000	25.948
ASM-2734-20	27.0	+0.065 +0.195	34.0	20.0	27.195	27.065	34.025	34.000	27.000	26.948
ASM-2734-30	27.0	+0.065 +0.195	34.0	30.0	27.195	27.065	34.025	34.000	27.000	26.948
ASM-2734-40	27.0	+0.065 +0.195	34.0	40.0	27.195	27.065	34.025	34.000	27.000	26.948
ASM-2833-20	28.0	+0.065 +0.195	33.0	20.0	28.195	28.065	33.025	33.000	28.000	27.948
ASM-2836-20	28.0	+0.065 +0.195	36.0	20.0	28.195	28.065	36.025	36.000	28.000	27.948
ASM-2836-30	28.0	+0.065 +0.195	36.0	30.0	28.195	28.065	36.025	36.000	28.000	27.948
ASM-2836-40	28.0	+0.065 +0.195	36.0	40.0	28.195	28.065	36.025	36.000	28.000	27.948
ASM-3038-20	30.0	+0.065 +0.195	38.0	20.0	30.195	30.065	38.025	38.000	30.000	29.948
ASM-3038-30	30.0	+0.065 +0.195	38.0	30.0	30.195	30.065	38.025	38.000	30.000	29.948
ASM-3038-40	30.0	+0.065 +0.195	38.0	40.0	30.195	30.065	38.025	38.000	30.000	29.948
ASM-3240-20	32.0	+0.080 +0.240	40.0	20.0	32.240	32.080	40.025	40.000	32.000	31.938
ASM-3240-30	32.0	+0.080 +0.240	40.0	30.0	32.240	32.080	40.025	40.000	32.000	31.938
ASM-3240-40	32.0	+0.080 +0.240	40.0	40.0	32.240	32.080	40.025	40.000	32.000	31.938

iglide® A200
Sleeve - MM

PDF: www.igus.com/iglide-pdfs
CAD: www.igus.com/iglide-CAD
RoHS info: www.igus.com/RoHS

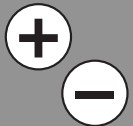

A200



iglide® Plain Bearings A200 - Flange, MM

iglide® A200
Flange - MM

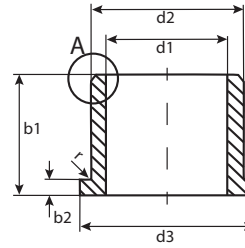
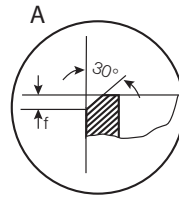

For tolerance values
please refer to page 12.4

r = max. 0.5

Dimensions according to ISO 3547-1 and special dimensions

Part Number	d1 ¹⁾		d2	d3	b1	b2	I.D. After Pressfit		Housing Bore		Shaft Size	
	After Pressfit in Ø H7						Max.	Min.	Max.	Min.	Max.	Min.
AFM-0103-02	1.0	+0.020 +0.080	3.0	5.0	2.0	1.0	1.080	1.020	3.080	3.000	1.000	.9750
AFM-0104-02	1.5	+0.020 +0.080	4.0	6.0	2.0	1.0	1.580	1.520	4.012	4.000	1.500	1.475
AFM-0205-03	2.0	+0.020 +0.080	5.0	8.0	3.0	1.5	2.080	2.020	5.012	5.000	2.000	1.975
AFM-0206-03	2.5	+0.020 +0.080	6.0	9.0	3.0	1.5	2.080	2.020	5.012	5.000	2.000	1.975
AFM-0306-04	3.0	+0.020 +0.080	6.0	9.0	4.0	1.5	3.080	3.020	6.012	6.000	3.000	2.975
AFM-0408-04	4.0	+0.030 +0.105	8.0	12.0	4.0	2.0	4.105	4.030	8.015	8.000	4.000	3.970
AFM-0408-06	4.0	+0.030 +0.105	8.0	12.0	6.0	2.0	4.105	4.030	8.015	8.000	4.000	3.970
AFM-0507-05	5.0	+0.030 +0.105	7.0	11.0	5.0	1.0	5.105	5.030	7.012	7.000	5.000	4.970
AFM-0509-05	5.0	+0.030 +0.105	9.0	13.0	5.0	2.0	5.105	5.030	9.015	9.000	5.000	4.970
AFM-0509-06	5.0	+0.030 +0.105	9.0	13.0	6.0	2.0	5.105	5.030	9.015	9.000	5.000	4.970
AFM-0509-08	5.0	+0.030 +0.105	9.0	13.0	8.0	2.0	5.105	5.030	9.015	9.000	5.000	4.970
AFM-0610-04	6.0	+0.030 +0.105	10.0	14.0	4.0	2.0	6.105	6.030	10.015	10.000	6.000	5.970
AFM-0610-06	6.0	+0.030 +0.105	10.0	14.0	6.0	2.0	6.105	6.030	10.015	10.000	6.000	5.970
AFM-0610-10	6.0	+0.030 +0.105	10.0	14.0	10.0	2.0	6.105	6.030	10.015	10.000	6.000	5.970
AFM-0612-06	6.0	+0.030 +0.105	12.0	14.0	6.0	3.0	6.105	6.030	12.018	12.000	6.000	5.970
AFM-0612-08	6.0	+0.030 +0.105	12.0	14.0	8.0	3.0	6.105	6.030	12.018	12.000	6.000	5.970
AFM-0612-10	6.0	+0.030 +0.105	12.0	14.0	10.0	3.0	6.105	6.030	12.018	12.000	6.000	5.970
AFM-0711-08	7.0	+0.040 +0.130	11.0	15.0	8.0	2.0	7.130	7.040	11.018	11.000	7.000	6.964
AFM-0811-08	8.0	+0.040 +0.130	11.0	13.0	8.0	2.0	8.130	8.040	11.018	11.000	8.000	7.964
AFM-0812-06	8.0	+0.040 +0.130	12.0	13.0	6.0	2.0	8.130	8.040	12.018	12.000	8.000	7.964
AFM-0812-08	8.0	+0.040 +0.130	12.0	16.0	8.0	2.0	8.130	8.040	12.018	12.000	8.000	7.964
AFM-0812-12	8.0	+0.040 +0.130	12.0	16.0	12.0	2.0	8.130	8.040	12.018	12.000	8.000	7.964
AFM-0812-22	8.0	+0.040 +0.130	12.0	16.0	22.0	2.0	8.130	8.040	12.018	12.000	8.000	7.964
AFM-0814-06	8.0	+0.040 +0.130	14.0	18.0	6.0	3.0	8.130	8.040	14.018	14.000	8.000	7.964
AFM-0814-10	8.0	+0.040 +0.130	14.0	18.0	10.0	3.0	8.130	8.040	14.018	14.000	8.000	7.964
AFM-0914-06	9.0	+0.040 +0.130	14.0	19.0	6.0	2.0	9.130	9.040	14.018	14.000	9.000	8.964
AFM-0914-10	9.0	+0.040 +0.130	14.0	19.0	10.0	2.0	9.130	9.040	14.018	14.000	9.000	8.964
AFM-0914-14	9.0	+0.040 +0.130	14.0	19.0	14.0	2.0	9.130	9.040	14.018	14.000	9.000	8.964
AFM-1012-10	10.0	+0.040 +0.130	12.0	18.0	10.0	1.0	10.130	10.040	12.018	12.000	10.000	9.964
AFM-1016-06	10.0	+0.040 +0.130	16.0	22.0	6.0	3.0	10.130	10.040	16.018	16.000	10.000	9.964
AFM-1016-08	10.0	+0.040 +0.130	16.0	22.0	8.0	3.0	10.130	10.040	16.018	16.000	10.000	9.964
AFM-1016-10	10.0	+0.040 +0.130	16.0	22.0	10.0	3.0	10.130	10.040	16.018	16.000	10.000	9.964
AFM-1016-16	10.0	+0.040 +0.130	16.0	22.0	16.0	3.0	10.130	10.040	16.018	16.000	10.000	9.964
AFM-101620-10	10.0	+0.040 +0.130	16.0	20.0	10.0	3.0	10.130	10.040	16.018	16.000	10.000	9.964
AFM-1214-12	12.0	+0.050 +0.160	14.0	20.0	12.0	1.0	12.160	12.050	14.018	14.000	12.000	11.957
AFM-1218-08	12.0	+0.050 +0.160	18.0	24.0	8.0	3.0	12.160	12.050	18.018	18.000	12.000	11.957
AFM-1218-10	12.0	+0.050 +0.160	18.0	22.0	10.0	3.0	12.160	12.050	18.018	18.000	12.000	11.957
AFM-1218-12	12.0	+0.050 +0.160	18.0	24.0	12.0	3.0	12.160	12.050	18.018	18.000	12.000	11.957
AFM-1218-15	12.0	+0.050 +0.160	18.0	22.0	15.0	3.0	12.160	12.050	18.018	18.000	12.000	11.957
AFM-1218-20	12.0	+0.050 +0.160	18.0	22.0	20.0	3.0	12.160	12.050	18.018	18.000	12.000	11.957
AFM-1420-10	14.0	+0.050 +0.160	20.0	25.0	10.0	3.0	14.160	14.050	20.021	20.000	14.000	13.957

Telephone 1-800-521-2747
Fax 1-401-438-7270

Internet: <http://www.igus.com>
email: sales@igus.com
QuickSpec: <http://www.igus.com/iglide-quickspec>

iglide® Plain Bearings A200 - Flange, MM

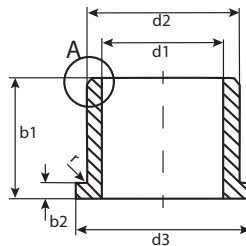
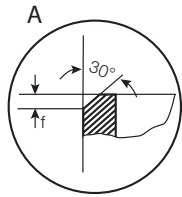

For tolerance values
please refer to page 12.4

$r = \max. 0.5$

Dimensions according to ISO 3547-1 and special dimensions

Part Number	d1 ¹⁾ After Pressfit in Ø H7	d1-Tolerance +0.050 +0.160	d2	d3 d13	b1 h13	b2 -0,14	I.D. After Pressfit		Housing Bore		Shaft Size	
							Max.	Min.	Max.	Min.	Max.	Min.
AFM-1420-15	14.0	+0.050 +0.160	20.0	25.0	15.0	3.0	14.160	14.050	20.021	20.000	14.000	13.957
AFM-1420-20	14.0	+0.050 +0.160	20.0	25.0	20.0	3.0	14.160	14.050	20.021	20.000	14.000	13.957
AFM-1521-10	15.0	+0.050 +0.160	21.0	27.0	10.0	3.0	15.160	15.050	21.021	21.000	15.000	14.957
AFM-1521-15	15.0	+0.050 +0.160	21.0	27.0	15.0	3.0	15.160	15.050	21.021	21.000	15.000	14.957
AFM-1521-20	15.0	+0.050 +0.160	21.0	27.0	20.0	3.0	15.160	15.050	21.021	21.000	15.000	14.957
AFM-1521-25	15.0	+0.050 +0.160	21.0	27.0	25.0	3.0	15.160	15.050	21.021	21.000	15.000	14.957
AFM-1622-12	16.0	+0.050 +0.160	22.0	28.0	12.0	3.0	16.160	16.050	22.021	22.000	16.000	15.957
AFM-1622-15	16.0	+0.050 +0.160	22.0	28.0	15.0	3.0	16.160	16.050	22.021	22.000	16.000	15.957
AFM-1622-20	16.0	+0.050 +0.160	22.0	28.0	20.0	3.0	16.160	16.050	22.021	22.000	16.000	15.957
AFM-1622-25	16.0	+0.050 +0.160	22.0	28.0	25.0	3.0	16.160	16.050	22.021	22.000	16.000	15.957
AFM-1824-12	18.0	+0.050 +0.160	24.0	30.0	12.0	3.0	18.160	18.050	24.021	24.000	18.000	17.957
AFM-1824-18	18.0	+0.050 +0.160	24.0	30.0	18.0	3.0	18.160	18.050	24.021	24.000	18.000	17.957
AFM-1824-20	18.0	+0.050 +0.160	24.0	30.0	20.0	3.0	18.160	18.050	24.021	24.000	18.000	17.957
AFM-1824-30	18.0	+0.050 +0.160	24.0	30.0	30.0	3.0	18.160	18.050	24.021	24.000	18.000	17.957
AFM-2026-15	20.0	+0.065 +0.195	26.0	32.0	15.0	3.0	20.195	20.065	26.021	26.000	20.000	19.948
AFM-2026-20	20.0	+0.065 +0.195	26.0	32.0	20.0	3.0	20.195	20.065	26.021	26.000	20.000	19.948
AFM-2026-30	20.0	+0.065 +0.195	26.0	32.0	30.0	3.0	20.195	20.065	26.021	26.000	20.000	19.948
AFM-2228-15	22.0	+0.065 +0.195	28.0	34.0	15.0	3.0	22.195	22.065	28.021	28.000	22.000	21.948
AFM-2228-20	22.0	+0.065 +0.195	28.0	34.0	20.0	3.0	22.195	22.065	28.021	28.000	22.000	21.948
AFM-2228-30	22.0	+0.065 +0.195	28.0	34.0	30.0	3.0	22.195	22.065	28.021	28.000	22.000	21.948
AFM-2430-15	24.0	+0.065 +0.195	30.0	36.0	15.0	3.0	24.195	24.065	30.025	30.000	24.000	23.948
AFM-2430-20	24.0	+0.065 +0.195	30.0	36.0	20.0	3.0	24.195	24.065	30.025	30.000	24.000	23.948
AFM-2430-30	24.0	+0.065 +0.195	30.0	36.0	30.0	3.0	24.195	24.065	30.025	30.000	24.000	23.948
AFM-2532-20	25.0	+0.065 +0.195	32.0	38.0	20.0	4.0	25.195	25.065	32.025	32.000	25.000	24.948
AFM-2532-30	25.0	+0.065 +0.195	32.0	38.0	30.0	4.0	25.195	25.065	32.025	32.000	25.000	24.948
AFM-2532-40	25.0	+0.065 +0.195	32.0	38.0	40.0	4.0	25.195	25.065	32.025	32.000	25.000	24.948
AFM-2734-20	27.0	+0.065 +0.195	34.0	40.0	20.0	4.0	27.195	27.065	34.025	34.000	27.000	26.948
AFM-2734-30	27.0	+0.065 +0.195	34.0	40.0	30.0	4.0	27.195	27.065	34.025	34.000	27.000	26.948
AFM-2734-40	27.0	+0.065 +0.195	34.0	40.0	40.0	4.0	27.195	27.065	34.025	34.000	27.000	26.948
AFM-2836-20	28.0	+0.065 +0.195	36.0	42.0	20.0	4.0	28.195	28.065	36.025	36.000	28.000	27.948
AFM-2836-30	28.0	+0.065 +0.195	36.0	42.0	30.0	4.0	28.195	28.065	36.025	36.000	28.000	27.948
AFM-2836-40	28.0	+0.065 +0.195	36.0	42.0	40.0	4.0	28.195	28.065	36.025	36.000	28.000	27.948
AFM-3038-20	30.0	+0.065 +0.195	38.0	44.0	20.0	4.0	30.195	30.065	38.025	38.000	30.000	29.948
AFM-3038-30	30.0	+0.065 +0.195	38.0	44.0	30.0	4.0	30.195	30.065	38.025	38.000	30.000	29.948
AFM-3038-40	30.0	+0.065 +0.195	38.0	44.0	40.0	4.0	30.195	30.065	38.025	38.000	30.000	29.948
AFM-3240-20	32.0	+0.080 +0.240	40.0	46.0	20.0	4.0	32.240	32.080	40.025	40.000	32.000	31.938
AFM-3240-30	32.0	+0.080 +0.240	40.0	46.0	30.0	4.0	32.240	32.080	40.025	40.000	32.000	31.938
AFM-3240-40	32.0	+0.080 +0.240	40.0	46.0	40.0	4.0	32.240	32.080	40.025	40.000	32.000	31.938

iglide® A200
Flange - MM

PDF: www.igus.com/iglide-pdfs
CAD: www.igus.com/iglide-CAD
RoHS info: www.igus.com/RoHS

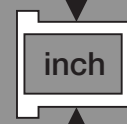
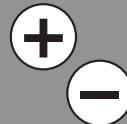



iglide® Plain Bearings A200 - Notes

iglide® A200

Telephone 1-800-521-2747
Fax 1-401-438-7270

Internet: <http://www.igus.com>
email: sales@igus.com
QuickSpec: <http://www.igus.com/iglide-quickspec>

igus[®]



iglide[®] T500

Product Range

- Standard Styles:
Sleeve, Flange and Thrust Washer
- Custom shapes and sizes available
- Inner diameters:
Inch sizes from 1/8 - 2-3/4 in.
Metric sizes from 2 - 75 mm

Part Number Structure

Part Number Structure

T S I-02 03-03

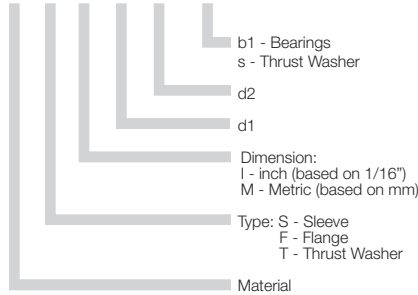

Permissible Surface Speeds

	Continuous fpm	Short Term fpm
Rotating	295	689
Oscillating	216	492
Linear	984	1968

Usage Guidelines



- When especially high temperature resistance is necessary
- For loads up to 21,750 psi
- For linear movements with a hard stainless steel
- For linear movements especially at high temperatures
- When universal resistance to chemicals is required



- For very low wear at high loads
➤ iglide® Q, Z
- For edge compression
➤ iglide® Z



Visit www.igus.com
to use our online
expert system

Material Table

General Properties	Unit	iglide® T500	Testing Method
Density	g/cm ³	1.44	
Color		black	
Max. moisture absorption at 73°F / 50% r.h.	% weight	0.1	DIN 53495
Max. moisture absorption	% weight	0.5	
Coefficient of friction, dynamic against steel	μ	0.09 - 0.27	
p x v-value, max. (dry)	psi x fpm	37,700	

Mechanical Properties

Modulus of elasticity	psi	1,174,500	DIN 53457
Tensile strength at 68°F	psi	24,650	DIN 53452
Compressive strength	psi	14,500	
Permissible static surface pressure (68°F)	psi	21,750	
Shore D-hardness		85	DIN 53505

Physical and Thermal Properties

Max. long-term application temperature	°F	482	
Max. short-term application temperature	°F	599	
Min. application temperature	°F	-148	
Thermal conductivity	W/m x K	0.6	ASTM C 177
Coefficient of thermal expansion (to 73°F)	K ⁻¹ x 10 ⁻⁵	5	DIN 53752

Electrical Properties

Specific volume resistance	Ωcm	< 10 ⁵	DIN IEC 93
Surface resistance	Ω	< 10 ³	DIN 53482

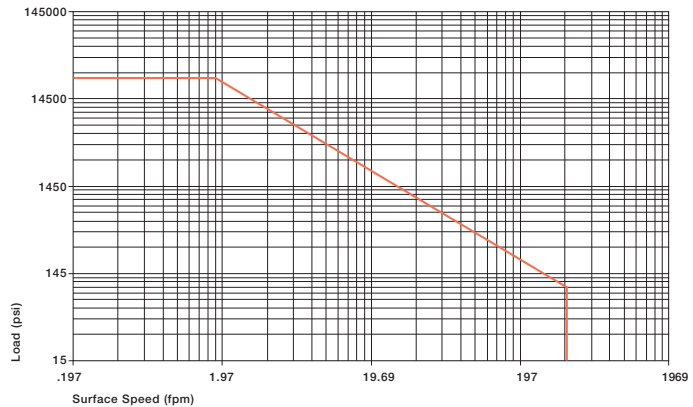

Graph. 13.1: Permissible p x v values for iglide® T500 running dry against a steel shaft, at 68°F

iglide® T500 is defined by its combination of high temperature-resistance with compressive strength, along with high resistance to chemicals.

Compressive Strength

Graph 13.2 shows how iglide® T500 plain bearings deform elastically under load. Graph 13.1 on the preceding page shows the maximum p x v values at room temperature. In this case, the compressive strength of iglide® T500 even measures up to that of steel.

Graph 13.3 shows the special compression resistance of iglide® T500 also at very high temperatures. Even at the highest long-term application temperature of 482°F, iglide® T500 plain bearings still withstand a static surface pressure of approximately 4350 psi.

► Compressive Strength, Page 1.3

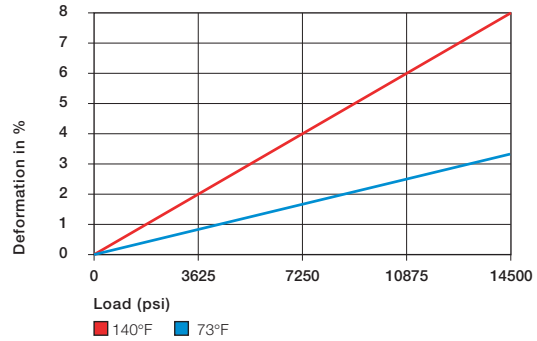

Graph 13.2: Deformation under load and temperature

Permissible Surface Speeds

iglide® T500 is designed for higher speeds than other iglide® bearings. This is due to its high temperature resistance and excellent heat conductivity. These benefits are readily apparent in the p x v values of max. 1.32 psi x fpm.

However, only the smallest radial loads may act on the bearings. At the given speeds, friction can cause a temperature increase to maximum permissible levels.

► Surface Speed, Page 1.5
► p x v Value, Page 1.6

	Continuous fpm	Short Term fpm
Rotating	295	689
Oscillating	216	492
Linear	984	1968

Table 13.2: Maximum surface speeds

Temperatures

In terms of temperature resistance, iglide® T500 has also taken on a leading position. Having a permissible long-term application temperature of 482°F, iglide® T500 will even withstand 599°F for the short-term.

As in all thermoplastics, the compression resistance of T500 decreases with increasing temperature. However, the wear drops considerably when used within the observed temperature range of 73°F to 302°F. In certain cases, relaxation of the bearing can even occur at temperatures greater than 338°F. This could lead to, after re-cooling, the bearing moving out of the housing. At temperatures over 338°F, the axial security of the bearing in the housing needs to be tested. If necessary, secondary measures must be taken to mechanically secure the bearing. Please contact us if you have questions on bearing use.

► Application Temperatures, Page 1.7

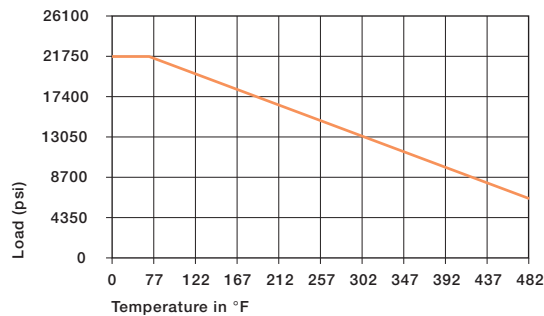

Graph 13.3: Recommended maximum permissible static surface pressure of iglide® T500 as a result of temperature

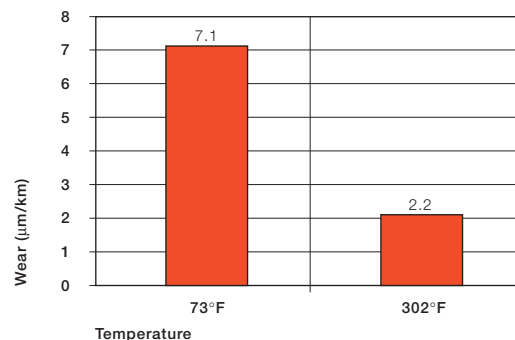

Graph 13.4: Wear of iglide® T500, Rotation with p = 108 psi, v = 98 fpm, shaft made of Cold Rolled Steel

iglide® T500	Application Temperature
Minimum	- 148 °F
Max., long-term	+ 482 °F
Max., short-term	+ 599 °F

Table 13.3: Temperature limits for iglide® T500

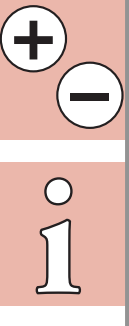

Installation Tolerances

iglide® T500 plain bearings are oversized before being pressfit. After proper installation into a recommended housing bore, the inner diameter adjusts to meet our specified tolerances. Please adhere to the catalog specifications for housing bore and recommended shaft sizes. This will help to ensure optimal performance of iglide® plain bearings.

- See Tolerance Table, Page 1.14
- Testing Methods, Page 1.15

For Inch Size Bearings		
Length Tolerance (b1)		Length of Chamfer (f)
Length (inches)	Tolerance (h13) (inches)	Based on d1
0.1181 to 0.2362	-0.0000 /-0.0071	f = .012 → d ₁ .040" - .236"
0.2362 to 0.3937	-0.0000 /-0.0087	f = .019 → d ₁ > .236" - .472"
0.3937 to 0.7086	-0.0000 /-0.0106	f = .031 → d ₁ > .472" - 1.18"
0.7086 to 1.1811	-0.0000 /-0.0130	f = .047 → d ₁ > 1.18"
1.1811 to 1.9685	-0.0000 /-0.0154	
1.9685 to 3.1496	-0.0000 /-0.0181	

For Metric Size Bearings		
Length Tolerance (b1)		Length of Chamfer (f)
Length (mm)	Tolerance (h13) (µm)	Based on d1
1 to 3	-0 /-140	f = 0.3 → d ₁ 1 - 6 mm
> 3 to 6	-0 /-180	f = 0.5 → d ₁ > 6 - 12 mm
> 6 to 10	-0 /-220	f = 0.8 → d ₁ > 12 - 30 mm
>10 to 18	-0 /-270	
>18 to 30	-0 /-330	
>30 to 50	-0 /-390	
>50 to 80	-0 /-460	

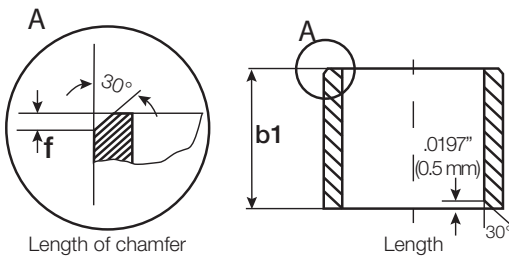

Friction and Wear

Similar to wear resistance, the coefficient of friction μ also changes with the load. The coefficient of friction increases with an increase in surface speed. On the other hand, an increased load has an inverse effect: the coefficient of friction decreases (see Graph 13.5 and 13.6). This explains the excellent performance of iglide® T500 plain bearings for high loads.

Friction and wear are also, dependent to a large degree on the shafting partner. Shafts that are too smooth increase the coefficient of friction of the bearing. For iglide T500 a ground surface with an average roughness range of 24 - 32 rms is recommended for the shaft.

- Coefficients of friction and surfaces, Page 1.8
- Wear resistance, Page 1.9

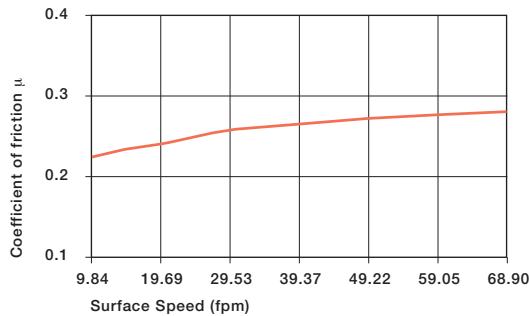

Graph 13.5: Coefficient of friction for iglide® T500 as a result of the surface speed; p = 108 psi, shaft Cold Rolled Steel

iglide® T500	Coefficient of Friction
Dry	0.09 - 0.27
Grease	0.09
Oil	0.04
Water	0.04

Table 13.4: Coefficient of friction for iglide® T500 against steel (Shaft finish = 40 rms, 50 HRC)

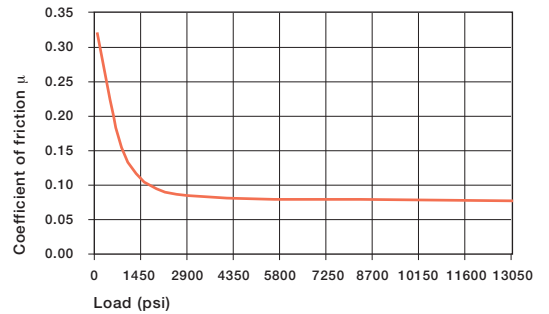

Graph 13.6: Coefficient of friction for iglide® T500 as a result of the load, v = 1.97 fpm

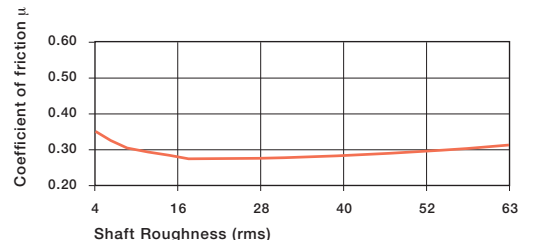

Graph 13.7: Coefficients of friction as a function of the shaft surface (shaft Cold Rolled Steel)

Shaft Materials

Graph 13.8 and 13.9 show results of testing different shaft materials with plain bearings made of iglide® T500. For low loads in rotating operation, the best wear values are found with 303 Stainless and HR Carbon Steel shafts. However, above a load of 290 psi, the bearing wear greatly increases with these two shaft materials. For the higher load range, hard-chromed shafts or Cold Rolled Steel shafts are advantageous. In oscillating operation at low loads, similar wear values for cold rolled Steel and 303 stainless steel shafts occur. The wear is somewhat higher than during rotational movements.

If the shaft material you plan to use is not contained in this list, please contact us.

► Shaft Materials, Page 1.11

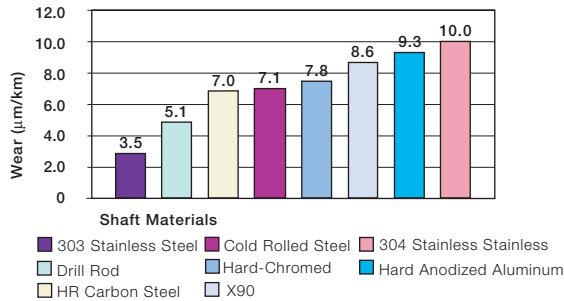

Graph 13.8: Wear of iglide® T500 with different shaft materials, $p = 108$ psi, $v = 98$ fpm

Chemical Resistance

iglide® T500 plain bearings are close to universally resistant to chemicals.

They are only attacked by concentrated nitric acid and by sulfuric acid with acidity levels over 65%. The list at the end of this catalog provides more comprehensive detailed information.

► Chemicals Table, Page 1.16

Medium	Resistance
Alcohol	+
Hydrocarbons, chlorinated	+
Greases, oils without additives	+
Fuels	+
Weak acids	+
Strong acids	+
Weak alkaline	+
Strong alkaline	+

+ resistant, 0 conditionally resistant, - not resistant

Table 13.5: Chemical resistance of iglide® T500
All data given concerns the chemical resistance at room temperature (68°F). For a complete list, see page 1.16

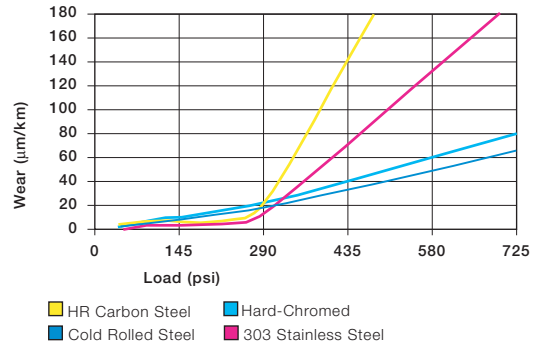

Graph 13.9: Wear of iglide® T500 with different shaft materials in rotational operation

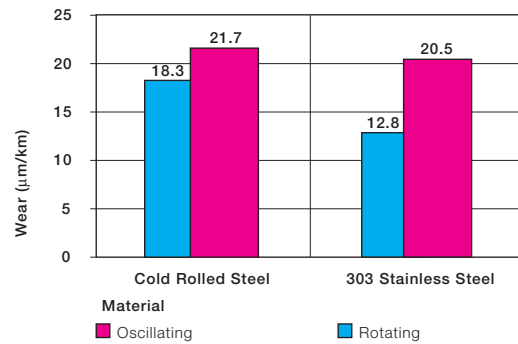

Graph 13.10: Wear for oscillating and rotating applications with different shaft materials $p = 290$ psi

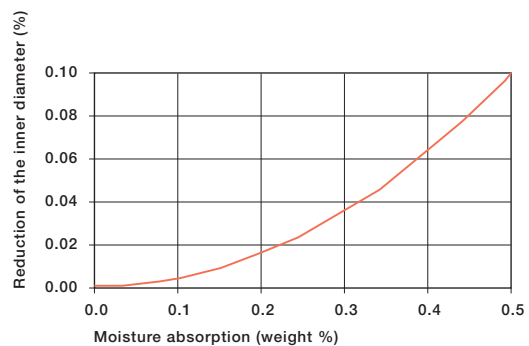

Graph 13.11: Effect of moisture absorption on iglide® T500 plain bearings

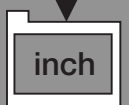
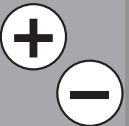

Radiation Resistance

Plain bearings made from iglide® T500 are resistant to radiation up to an intensity of 1×10^5 Gy. iglide® T500 is the most radioactive-resistant material of the iglide® product line. iglide® T500 is extremely resistant to hard gamma radiation and withstands a radiation dose of 1000 Mrad without detectable change in its properties. The material also withstands an alpha or beta radiation of 10,000 Mrad with practically no damage.

UV Resistance

The excellent material properties of iglide® T500 do not change under UV radiation and other weathering effects.

Vacuum

In a vacuum environment, iglide® T500 plain bearings can be used virtually without restrictions. Outgassing takes place to a very limited extent.

Electrical Properties

iglide® T500 plain bearings are electrically conductive.

iglide® T500

Specific volume resistance	< $10^5 \Omega\text{cm}$
Surface Resistance	< $10^3 \Omega$

Table 13.6: Electrical properties of iglide® T500

Application Examples



Picture 13.1: Intake control device



Picture 13.2: Battery decanting



Picture 13.3: Flaps, valves



Picture 13.4: Catering equipment



Picture 13.5: Application on an outboard engine



Picture 13.6: iglide® T500 plain bearing in valve applications

iglide® Plain Bearings T500 - Sleeve, Inch

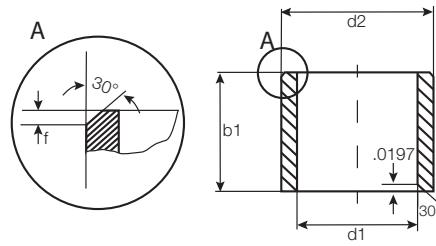

For tolerance values
please refer to page 13.4

iglide® T500
Sleeve - Inch

Part Number	d1	d2	b1	I.D. After Pressfit		Housing Bore		Shaft Size	
				Max.	Min.	Max.	Min.	Max.	Min.
TSI-0203-03	1/8	3/16	3/16	.1269	.1251	.1878	.1873	.1243	.1236
TSI-0203-05	1/8	3/16	5/16	.1269	.1251	.1878	.1873	.1243	.1236
TSI-0203-06	1/8	3/16	3/8	.1269	.1251	.1878	.1873	.1243	.1236
TSI-0304-03	3/16	1/4	3/16	.1892	.1873	.2503	.2497	.1865	.1858
TSI-0304-04	3/16	1/4	1/4	.1892	.1873	.2503	.2497	.1865	.1858
TSI-0304-06	3/16	1/4	3/8	.1892	.1873	.2503	.2497	.1865	.1858
TSI-0304-08	3/16	1/4	1/2	.1892	.1873	.2503	.2497	.1865	.1858
TSI-0405-04	1/4	5/16	1/4	.2521	.2498	.3128	.3122	.2490	.2481
TSI-0405-06	1/4	5/16	3/8	.2521	.2498	.3128	.3122	.2490	.2481
TSI-0405-08	1/4	5/16	1/2	.2521	.2498	.3128	.3122	.2490	.2481
TSI-0506-04	5/16	3/8	1/4	.3148	.3125	.3753	.3747	.3115	.3106
TSI-0506-06	5/16	3/8	3/8	.3148	.3125	.3753	.3747	.3115	.3106
TSI-0506-08	5/16	3/8	1/2	.3148	.3125	.3753	.3747	.3115	.3106
TSI-0607-04	3/8	15/32	1/4	.3773	.3750	.4691	.4684	.3740	.3731
TSI-0607-05	3/8	15/32	5/16	.3773	.3750	.4691	.4684	.3740	.3731
TSI-0607-06	3/8	15/32	3/8	.3773	.3750	.4691	.4684	.3740	.3731
TSI-0607-08	3/8	15/32	1/2	.3773	.3750	.4691	.4684	.3740	.3731
TSI-0607-10	3/8	15/32	5/8	.3773	.3750	.4691	.4684	.3740	.3731
TSI-0607-12	3/8	15/32	3/4	.3773	.3750	.4691	.4684	.3740	.3731
TSI-0708-04	7/16	17/32	1/4	.4406	.4379	.5316	.5309	.4365	.4355
TSI-0708-08	7/16	17/32	1/2	.4406	.4379	.5316	.5309	.4365	.4355
TSI-0708-10	7/16	17/32	5/8	.4406	.4379	.5316	.5309	.4365	.4355
TSI-0708-12	7/16	17/32	3/4	.4406	.4379	.5316	.5309	.4365	.4355
TSI-0709-06	7/16	17/32	3/8	.4406	.4379	.5316	.5309	.4365	.4355
TSI-0809-04	1/2	19/32	1/4	.5030	.5003	.5941	.5934	.4990	.4980
TSI-0809-06	1/2	19/32	3/8	.5030	.5003	.5941	.5934	.4990	.4980
TSI-0809-08	1/2	19/32	1/2	.5030	.5003	.5941	.5934	.4990	.4980
TSI-0809-10	1/2	19/32	5/8	.5030	.5003	.5941	.5934	.4990	.4980
TSI-0809-12	1/2	19/32	3/4	.5030	.5003	.5941	.5934	.4990	.4980
TSI-0809-16	1/2	19/32	1	.5030	.5003	.5941	.5934	.4990	.4980
TSI-0910-08	9/16	21/32	1/2	.5655	.5627	.6566	.6559	.5615	.5605
TSI-0910-12	9/16	21/32	3/4	.5655	.5627	.6566	.6559	.5615	.5605
TSI-1011-04	5/8	23/32	1/4	.6280	.6253	.7192	.7184	.6240	.6230
TSI-1011-06	5/8	23/32	3/8	.6280	.6253	.7192	.7184	.6240	.6230
TSI-1011-08	5/8	23/32	1/2	.6280	.6253	.7192	.7184	.6240	.6230
TSI-1011-10	5/8	23/32	5/8	.6280	.6253	.7192	.7184	.6240	.6230
TSI-1011-12	5/8	23/32	3/4	.6280	.6253	.7192	.7184	.6240	.6230
TSI-1011-16	5/8	23/32	1	.6280	.6253	.7192	.7184	.6240	.6230
TSI-1112-04	11/16	25/32	1/4	.6906	.6879	.7817	.7809	.6865	.6855
TSI-1112-14	11/16	25/32	7/8	.6906	.6879	.7817	.7809	.6865	.6855

PDF: www.igus.com/iglide-pdfs
CAD: www.igus.com/iglide-CAD
RoHS info: www.igus.com/RoHS

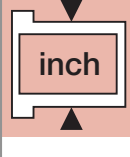
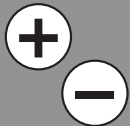

T500



iglide® Plain Bearings
T500 - Sleeve, Inch

iglide® T500
Sleeve - Inch

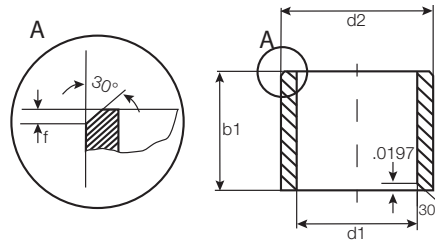

For tolerance values
please refer to page 13.4

Telephone 1-800-521-2747
Fax 1-401-438-7270

Internet: <http://www.igus.com>
email: sales@igus.com
QuickSpec: <http://www.igus.com/iglide-quickspec>

Part Number	d1	d2	b1	I.D. After Pressfit		Housing Bore		Shaft Size	
				Max.	Min.	Max.	Min.	Max.	Min.
TSI-1214-06	3/4	7/8	3/8	.7541	.7507	.8755	.8747	.7491	.7479
TSI-1214-08	3/4	7/8	1/2	.7541	.7507	.8755	.8747	.7491	.7479
TSI-1214-12	3/4	7/8	3/4	.7541	.7507	.8755	.8747	.7491	.7479
TSI-1214-16	3/4	7/8	1	.7541	.7507	.8755	.8747	.7491	.7479
TSI-1416-12	7/8	1	3/4	.8791	.8757	1.0005	.9997	.8741	.8729
TSI-1416-16	7/8	1	1	.8791	.8757	1.0005	.9997	.8741	.8729
TSI-1416-24	7/8	1	1 1/2	.8791	.8757	1.0005	.9997	.8741	.8729
TSI-1618-08	1	1 1/8	1/2	1.0041	1.0007	1.1255	1.1247	.9991	.9979
TSI-1618-12	1	1 1/8	3/4	1.0041	1.0007	1.1255	1.1247	.9991	.9979
TSI-1618-16	1	1 1/8	1	1.0041	1.0007	1.1255	1.1247	.9991	.9979
TSI-1618-24	1	1 1/8	1 1/2	1.0041	1.0007	1.1255	1.1247	.9991	.9979
TSI-1820-12	1 1/8	1 9/32	3/4	1.1288	1.1254	1.2818	1.2808	1.1238	1.1226
TSI-2022-10	1 1/4	1 13/32	5/8	1.2548	1.2508	1.4068	1.4058	1.2488	1.2472
TSI-2022-20	1 1/4	1 13/32	1 1/4	1.2548	1.2508	1.4068	1.4058	1.2488	1.2472
TSI-2426-12	1 1/2	1 21/32	3/4	1.5048	1.5008	1.6568	1.6558	1.4988	1.4972
TSI-2426-16	1 1/2	1 21/32	1	1.5048	1.5008	1.6568	1.6558	1.4988	1.4972
TSI-2426-24	1 1/2	1 21/32	1 1/2	1.5048	1.5008	1.6568	1.6558	1.4988	1.4972
TSI-2629-20	1 5/8	1 13/16	1 1/4	1.6297	1.6258	1.7818	1.7808	1.6238	1.6222
TSI-2831-16	1 3/4	1 15/16	1	1.7547	1.7507	1.9381	1.9371	1.7487	1.7471
TSI-3235-24	2	2 3/16	1 1/2	2.0057	2.0011	2.1883	2.1871	1.9981	1.9969
TSI-3235-32	2	2 3/16	2	2.0057	2.0011	2.1883	2.1871	1.9981	1.9969
TSI-3639-32	2 1/4	2 7/16	2	2.2577	2.2531	2.4377	2.4365	2.2507	2.2489
TSI-4447-32	2 3/4	2 15/16	2	2.7570	2.7523	2.9370	2.9358	2.7500	2.7490

iglide® Plain Bearings T500 - Flange, Inch

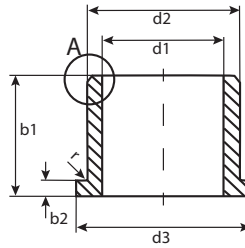
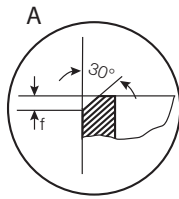

For tolerance values
please refer to page 13.4

r = max. .0197

iglide® T500
Flange - Inch

Part Number	d1	d2	b1	d3	b2 -.0055	I.D. After Pressfit		Housing Bore		Shaft Size	
						Max.	Min.	Max.	Min.	Max.	Min.
TFI-0203-03	1/8	3/16	3/16	.312	.032	.1269	.1251	.1878	.1873	.1243	.1236
TFI-0203-06	1/8	3/16	3/8	.312	.032	.1269	.1251	.1878	.1873	.1243	.1236
TFI-0304-04	3/16	1/4	1/4	.375	.032	.1892	.1873	.2503	.2497	.1865	.1858
TFI-0304-06	3/16	1/4	3/8	.375	.032	.1892	.1873	.2503	.2497	.1865	.1858
TFI-0304-08	3/16	1/4	1/2	.375	.032	.1892	.1873	.2503	.2497	.1865	.1858
TFI-0405-03	1/4	5/16	3/16	.500	.032	.2521	.2498	.3128	.3122	.2490	.2481
TFI-0405-04	1/4	5/16	1/4	.500	.032	.2521	.2498	.3128	.3122	.2490	.2481
TFI-0405-06	1/4	5/16	3/8	.500	.032	.2521	.2498	.3128	.3122	.2490	.2481
TFI-0405-08	1/4	5/16	1/2	.500	.032	.2521	.2498	.3128	.3122	.2490	.2481
TFI-0405-12	1/4	5/16	3/4	.500	.032	.2521	.2498	.3128	.3122	.2490	.2481
TFI-0506-04	5/16	3/8	1/4	.562	.032	.3148	.3125	.3753	.3747	.3115	.3106
TFI-0506-06	5/16	3/8	3/8	.562	.032	.3148	.3125	.3753	.3747	.3115	.3106
TFI-0506-08	5/16	3/8	1/2	.562	.032	.3148	.3125	.3753	.3747	.3115	.3106
TFI-0607-04	3/8	15/32	1/4	.687	.046	.3773	.3750	.4691	.4684	.3740	.3731
TFI-0607-06	3/8	15/32	3/8	.687	.046	.3773	.3750	.4691	.4684	.3740	.3731
TFI-0607-08	3/8	15/32	1/2	.687	.046	.3773	.3750	.4691	.4684	.3740	.3731
TFI-0607-12	3/8	15/32	3/4	.687	.046	.3773	.3750	.4691	.4684	.3740	.3731
TFI-0708-08	7/16	17/32	1/2	.750	.046	.4406	.4379	.5316	.5309	.4365	.4355
TFI-0809-04	1/2	19/32	1/4	.875	.046	.5030	.5003	.5941	.5934	.4990	.4980
TFI-0809-06	1/2	19/32	3/8	.875	.046	.5030	.5003	.5941	.5934	.4990	.4980
TFI-0809-08	1/2	19/32	1/2	.875	.046	.5030	.5003	.5941	.5934	.4990	.4980
TFI-0809-12	1/2	19/32	3/4	.875	.046	.5030	.5003	.5941	.5934	.4990	.4980
TFI-0809-16	1/2	19/32	1	.875	.046	.5030	.5003	.5941	.5934	.4990	.4980
TFI-1011-08	5/8	23/32	1/2	.937	.046	.6280	.6253	.7192	.7184	.6240	.6230
TFI-1011-12	5/8	23/32	3/4	.937	.046	.6280	.6253	.7192	.7184	.6240	.6230
TFI-1011-16	5/8	23/32	1	.937	.046	.6280	.6253	.7192	.7184	.6240	.6230
TFI-1011-24	5/8	23/32	1 1/2	.937	.046	.6280	.6253	.7192	.7184	.6240	.6230
TFI-1214-08	3/4	7/8	1/2	1.125	.062	.7541	.7507	.8755	.8747	.7491	.7479
TFI-1214-12	3/4	7/8	3/4	1.125	.062	.7541	.7507	.8755	.8747	.7491	.7479
TFI-1214-16	3/4	7/8	1	1.125	.062	.7541	.7507	.8755	.8747	.7491	.7479
TFI-1214-28	3/4	7/8	1 3/4	1.125	.062	.7541	.7507	.8755	.8747	.7491	.7479
TFI-1416-12	7/8	1	3/4	1.250	.062	.8791	.8757	1.0005	.9997	.8741	.8729
TFI-1416-16	7/8	1	1	1.250	.062	.8791	.8757	1.0005	.9997	.8741	.8729
TFI-1618-08	1	1 1/8	1/2	1.375	.062	1.0041	1.0007	1.1255	1.1247	.9991	.9979
TFI-1618-12	1	1 1/8	3/4	1.375	.062	1.0041	1.0007	1.1255	1.1247	.9991	.9979
TFI-1618-16	1	1 1/8	1	1.375	.062	1.0041	1.0007	1.1255	1.1247	.9991	.9979
TFI-1618-24	1	1 1/8	1 1/2	1.375	.062	1.0041	1.0007	1.1255	1.1247	.9991	.9979
TFI-1719-06	1 1/16	1 3/16	3/8	1.500	.062	1.0666	1.0633	1.1883	1.1875	1.0616	1.0604
TFI-1820-12	1 1/8	1 9/32	3/4	1.562	.078	1.1288	1.1254	1.2818	1.2808	1.1238	1.1226

PDF: www.igus.com/iglide-pdfs
CAD: www.igus.com/iglide-CAD
RoHS info: www.igus.com/RoHS

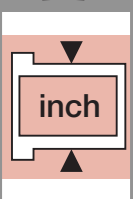

T500



iglide® Plain Bearings T500 - Flange, Inch

iglide® T500
Flange - Inch
Thrust Washer - MM

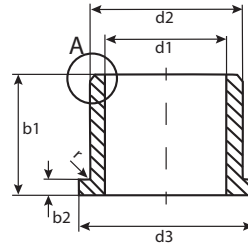
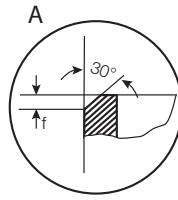

For tolerance values
please refer to page 13.4

$r = \max. .0197$

Telephone 1-800-521-2747
Fax 1-401-438-7270

Part Number	d1	d2	b1	d3	b2 -.0055	I.D. After Pressfit		Housing Bore		Shaft Size	
						Max.	Min.	Max.	Min.	Max.	Min.
TFI-2022-20	1 1/4	1 13/32	1 1/4	1.687	.078	1.2548	1.2508	1.4068	1.4058	1.2488	1.2472
TFI-2022-32	1 1/4	1 13/32	2	1.687	.078	1.2548	1.2508	1.4068	1.4058	1.2488	1.2472
TFI-2426-12	1 1/2	1 21/32	3/4	2.000	.078	1.5048	1.5008	1.6568	1.6558	1.4988	1.4972
TFI-2426-16	1 1/2	1 21/32	1	2.000	.078	1.5048	1.5008	1.6568	1.6558	1.4988	1.4972
TFI-2426-24	1 1/2	1 21/32	1 1/2	2.000	.078	1.5048	1.5008	1.6568	1.6558	1.4988	1.4972
TFI-2831-16	1 3/4	1 15/16	1	2.375	.093	1.7547	1.7507	1.9381	1.9371	1.7487	1.7471
TFI-3235-32	2	2 3/16	2	2.625	.093	2.0057	2.0011	2.1883	2.1871	1.9981	1.9969
TFI-4447-32	2 3/4	2 15/16	2	3.375	.093	2.7570	2.7523	2.9370	2.9358	2.7500	2.7490

iglide® T500 - Plain Bearings Thrust Washer - Inch

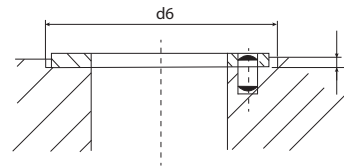
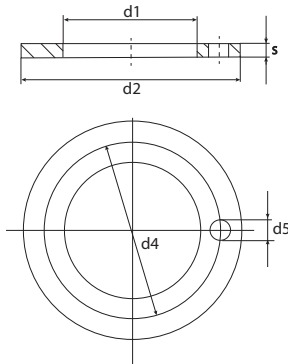

Part Number	d1 +.010	d2 -.010	s -.0020	d4 +-.005	d5 .015 +.005	h +.008	d6 +.005
TTI-0814-01	.500	.875	.0585	.692	.067	.040	.875
TTI-1018-01	.625	1.125	.0585	.880	.099	.040	1.125
TTI-1220-01	.750	1.250	.0585	1.005	.099	.040	1.250
TTI-1422-01	.875	1.375	.0585	1.125	.130	.040	1.375
TTI-1424-01	.875	1.500	.0585	1.192	.130	.040	1.500
TTI-1628-01	1.000	1.750	.0585	1.380	.130	.040	1.750
TTI-1826-01	1.125	1.625	.0585	—	—	.040	1.625
TTI-2034-01	1.250	2.125	.0585	1.692	.161	.040	2.125
TTI-2844-01	1.750	2.750	.0585	2.255	.192	.040	2.750
TTI-3248-01	2.000	3.000	.0895	2.505	.192	.070	3.000

Internet: <http://www.igus.com>
email: sales@igus.com
QuickSpec: <http://www.igus.com/iglide-quickspec>

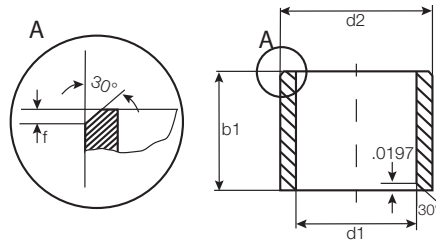

For tolerance values
please refer to page 13.4

Dimensions according to ISO 3547-1 and special dimensions

Part Number	d1	d1-Tolerance after pressfit in Ø H7	d2	b1 h13	I.D. After Pressfit		Housing Bore		Shaft Size	
					Max.	Min.	Max.	Min.	Max.	Min.
TSM-0203-03	2.0	+0.006 +0.046	3.5	3.0	2.046	2.006	3.580	3.500	2.000	1.975
TSM-0304-03	3.0	+0.006 +0.046	4.5	3.0	3.046	3.006	4.512	4.500	3.000	2.975
TSM-0304-06	3.0	+0.006 +0.046	4.5	6.0	3.046	3.006	4.512	4.500	3.000	2.975
TSM-0405-04	4.0	+0.010 +0.058	5.5	4.0	4.058	4.010	5.512	5.500	4.000	3.970
TSM-0507-035	5.0	+0.010 +0.058	7.0	3.5	5.058	5.010	7.015	7.000	5.000	4.970
TSM-0507-05	5.0	+0.010 +0.058	7.0	5.0	5.058	5.010	7.015	7.000	5.000	4.970
TSM-0507-08	5.0	+0.010 +0.058	7.0	8.0	5.058	5.010	7.015	7.000	5.000	4.970
TSM-0608-06	6.0	+0.010 +0.058	8.0	6.0	6.058	6.010	8.015	8.000	6.000	5.970
TSM-0608-08	6.0	+0.010 +0.058	8.0	8.0	6.058	6.010	8.015	8.000	6.000	5.970
TSM-0608-10	6.0	+0.010 +0.058	8.0	10.0	6.058	6.010	8.015	8.000	6.000	5.970
TSM-0608-13	6.0	+0.010 +0.058	8.0	13.0	6.058	6.010	8.015	8.000	6.000	5.970
TSM-0610-08	6.0	+0.010 +0.058	10.0	8.0	6.058	6.010	10.015	10.000	6.000	5.970
TSM-0610-20	6.0	+0.010 +0.058	10.0	20.0	6.058	6.010	10.015	10.000	6.000	5.970
TSM-0709-10	7.0	+0.013 +0.071	9.0	10.0	7.071	7.013	9.015	9.000	7.000	6.964
TSM-0709-12	7.0	+0.013 +0.071	9.0	12.0	7.071	7.013	9.015	9.000	7.000	6.964
TSM-0810-06	8.0	+0.013 +0.071	10.0	6.0	8.071	8.013	10.015	10.000	8.000	7.984
TSM-0810-08	8.0	+0.013 +0.071	10.0	8.0	8.071	8.013	10.015	10.000	8.000	7.964
TSM-0810-10	8.0	+0.013 +0.071	10.0	10.0	8.071	8.013	10.015	10.000	8.000	7.964
TSM-0810-15	8.0	+0.013 +0.071	10.0	15.0	8.071	8.013	10.015	10.000	8.000	7.964
TSM-1012-06	10.0	+0.013 +0.071	12.0	6.0	10.071	10.013	12.018	12.000	10.000	9.964
TSM-1012-08	10.0	+0.013 +0.071	12.0	8.0	10.071	10.013	12.018	12.000	10.000	9.964
TSM-1012-10	10.0	+0.013 +0.071	12.0	10.0	10.071	10.013	12.018	12.000	10.000	9.964
TSM-1012-12	10.0	+0.013 +0.071	12.0	12.0	10.071	10.013	12.018	12.000	10.000	9.964
TSM-1012-20	10.0	+0.013 +0.071	12.0	20.0	10.071	10.013	12.018	12.000	10.000	9.964
TSM-1214-035	12.0	+0.016 +0.086	14.0	3.5	12.086	12.016	14.018	14.000	12.000	11.957
TSM-1214-06	12.0	+0.016 +0.086	14.0	6.0	12.086	12.016	14.018	14.000	12.000	11.957
TSM-1214-08	12.0	+0.016 +0.086	14.0	8.0	12.086	12.016	14.018	14.000	12.000	11.957
TSM-1214-10	12.0	+0.016 +0.086	14.0	10.0	12.086	12.016	14.018	14.000	12.000	11.957
TSM-1214-12	12.0	+0.016 +0.086	14.0	12.0	12.086	12.016	14.018	14.000	12.000	11.957
TSM-1214-15	12.0	+0.016 +0.086	14.0	15.0	12.086	12.016	14.018	14.000	12.000	11.957
TSM-1214-20	12.0	+0.016 +0.086	14.0	20.0	12.086	12.016	14.018	14.000	12.000	11.957
TSM-1416-12	14.0	+0.016 +0.086	16.0	12.0	14.086	14.016	16.018	16.000	14.000	13.957
TSM-1416-15	14.0	+0.016 +0.086	16.0	15.0	14.086	14.016	16.018	16.000	14.000	13.957
TSM-1416-20	14.0	+0.016 +0.086	16.0	20.0	14.086	14.016	16.018	16.000	14.000	13.957
TSM-1517-15	15.0	+0.016 +0.086	17.0	15.0	15.086	15.016	17.018	17.000	15.000	14.957
TSM-1517-20	15.0	+0.016 +0.086	17.0	20.0	15.086	15.016	17.018	17.000	15.000	14.957

iglide® T500
Sleeve - MM

PDF: www.igus.com/iglide-pdfs
CAD: www.igus.com/iglide-CAD
RoHS info: www.igus.com/RoHS

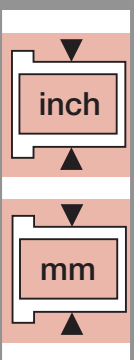
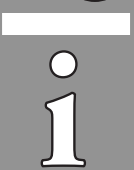

T500

iglus®

iglide® Plain Bearings T500 - Sleeve, MM

iglide® T500
Sleeve - MM

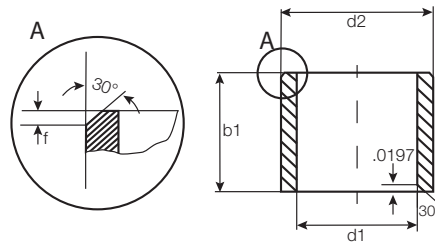

For tolerance values
please refer to page 13.4

Dimensions according to ISO 3547-1 and special dimensions

Part Number	d1	d1-Tolerance after pressfit in Ø H7	d2	b1 h13	I.D. After Pressfit		Housing Bore		Shaft Size	
					Max.	Min.	Max.	Min.	Max.	Min.
TSM-1618-10	16.0	+0.016 +0.086	18.0	10.0	16.086	16.016	18.018	18.000	16.000	15.957
TSM-1618-12	16.0	+0.016 +0.086	18.0	12.0	16.086	16.016	18.018	18.000	16.000	15.957
TSM-1618-15	16.0	+0.016 +0.086	18.0	15.0	16.086	16.016	18.018	18.000	16.000	15.957
TSM-1618-20	16.0	+0.016 +0.086	18.0	20.0	16.086	16.016	18.018	18.000	16.000	15.957
TSM-1618-35	16.0	+0.016 +0.086	18.0	35.0	16.086	16.016	18.018	18.000	16.000	15.957
TSM-1719-20	17.0	+0.016 +0.086	19.0	20.0	17.086	17.016	19.021	19.000	17.000	16.957
TSM-1820-15	18.0	+0.016 +0.086	20.0	15.0	18.086	18.016	20.021	20.000	18.000	17.957
TSM-1820-20	18.0	+0.016 +0.086	20.0	20.0	18.086	18.016	20.021	20.000	18.000	17.957
TSM-2022-14	20.0	+0.020 +0.104	22.0	14.0	20.104	20.020	22.021	22.000	20.000	19.948
TSM-2022-18	20.0	+0.020 +0.104	22.0	18.0	20.104	20.020	22.021	22.000	20.000	19.948
TSM-2022-20	20.0	+0.020 +0.104	22.0	20.0	20.104	20.020	22.021	22.000	20.000	19.948
TSM-2023-07	20.0	+0.020 +0.104	23.0	7.0	20.104	20.020	23.021	23.000	20.000	19.948
TSM-2023-10	20.0	+0.020 +0.104	23.0	10.0	20.101	20.020	23.021	23.000	20.000	19.948
TSM-2023-15	20.0	+0.020 +0.104	23.0	15.0	20.104	20.020	23.021	23.000	20.000	19.948
TSM-2023-20	20.0	+0.020 +0.104	23.0	20.0	20.104	20.020	23.021	23.000	20.000	19.948
TSM-2023-25	20.0	+0.020 +0.104	23.0	25.0	20.104	20.020	23.021	23.000	20.000	19.948
TSM-2023-30	20.0	+0.020 +0.104	23.0	30.0	20.104	20.020	23.021	23.000	20.000	19.948
TSM-2225-15	22.0	+0.020 +0.104	25.0	15.0	22.104	22.020	25.021	25.000	22.000	21.948
TSM-2225-20	22.0	+0.020 +0.104	25.0	20.0	22.104	22.020	25.021	25.000	22.000	21.948
TSM-2426-20	24.0	+0.020 +0.104	26.0	20.0	24.104	24.020	26.021	26.000	24.000	23.948
TSM-2427-20	24.0	+0.020 +0.104	27.0	20.0	24.104	24.020	27.021	27.000	24.000	23.948
TSM-2528-09	25.0	+0.020 +0.104	28.0	9.0	25.104	25.020	28.021	28.000	25.000	24.948
TSM-2528-12	25.0	+0.020 +0.104	28.0	12.0	25.104	25.020	28.021	28.000	25.000	24.948
TSM-2528-13	25.0	+0.020 +0.104	28.0	13.0	25.104	25.020	28.021	28.000	25.000	24.948
TSM-2528-15	25.0	+0.020 +0.104	28.0	15.0	25.104	25.020	28.021	28.000	25.000	24.948
TSM-2528-20	25.0	+0.020 +0.104	28.0	20.0	25.104	25.020	28.021	28.000	25.000	24.948
TSM-2528-30	25.0	+0.020 +0.104	28.0	30.0	25.104	25.020	28.021	28.000	25.000	24.948
TSM-2730-05	27.0	+0.020 +0.104	30.0	5.7	27.104	27.020	30.021	30.000	27.000	26.948
TSM-2832-20	28.0	+0.020 +0.104	32.0	20.0	28.104	28.020	32.025	32.000	28.000	27.948
TSM-2832-30	28.0	+0.020 +0.104	32.0	30.0	28.104	28.020	32.025	32.000	28.000	27.948
TSM-3034-20	30.0	+0.020 +0.104	34.0	20.0	30.104	30.020	34.025	34.000	30.000	29.948
TSM-3034-25	30.0	+0.020 +0.104	34.0	25.0	30.104	30.020	34.025	34.000	30.000	29.948
TSM-3034-30	30.0	+0.020 +0.104	34.0	30.0	30.104	30.020	34.025	34.000	30.000	29.948
TSM-3034-40	30.0	+0.020 +0.104	34.0	40.0	30.104	30.020	34.025	34.000	30.000	29.948
TSM-3236-25	32.0	+0.025 +0.125	36.0	25.0	32.125	32.025	36.025	36.000	32.000	31.938
TSM-3236-30	32.0	+0.025 +0.125	36.0	30.0	32.125	32.025	36.025	36.000	32.000	31.938
TSM-3539-20	35.0	+0.025 +0.125	39.0	20.0	35.125	35.025	39.025	39.000	35.000	34.938
TSM-3539-30	35.0	+0.025 +0.125	39.0	30.0	35.125	35.025	39.025	39.000	35.000	34.938

Telephone 1-800-521-2747
Fax 1-401-438-7270

Internet: <http://www.igus.com>
email: sales@igus.com
QuickSpec: <http://www.igus.com/iglide-quickspec>

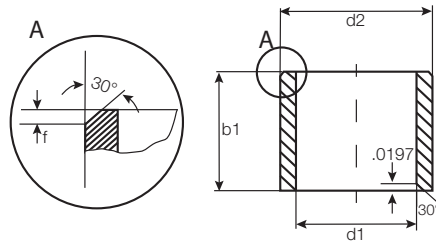

For tolerance values
please refer to page 13.4

Dimensions according to ISO 3547-1 and special dimensions

Part Number	d1	d1-Tolerance after pressfit in Ø H7	d2	b1 h13	I.D. After Pressfit		Housing Bore		Shaft Size	
					Max.	Min.	Max.	Min.	Max.	Min.
TSM-3539-40	35.0	+0.025 +0.125	39.0	40.0	35.125	35.025	39.025	39.000	35.000	34.938
TSM-3539-50	35.0	+0.025 +0.125	39.0	50.0	35.125	35.025	39.025	39.000	35.000	34.938
TSM-4044-30	40.0	+0.025 +0.125	44.0	30.0	40.125	40.025	44.025	44.000	40.000	39.938
TSM-4044-40	40.0	+0.025 +0.125	44.0	40.0	40.125	40.025	44.025	44.000	40.000	39.938
TSM-4044-50	40.0	+0.025 +0.125	44.0	50.0	40.125	40.025	44.025	44.000	40.000	39.938
TSM-4550-50	45.0	+0.025 +0.125	50.0	50.0	45.125	45.025	50.025	50.000	45.000	44.938
TSM-5055-30	50.0	+0.025 +0.125	55.0	30.0	50.125	50.025	55.030	55.000	50.000	49.938
TSM-5055-40	50.0	+0.025 +0.125	55.0	40.0	50.125	50.025	55.030	55.000	50.000	49.938
TSM-5055-60	50.0	+0.025 +0.125	55.0	60.0	50.125	50.025	55.030	55.000	50.000	49.938
TSM-5560-50	55.0	+0.030 +0.150	60.0	50.0	55.150	55.030	60.030	60.000	55.000	54.926
TSM-6065-45	60.0	+0.030 +0.150	65.0	45.0	60.150	60.030	65.030	65.000	60.000	59.926
TSM-6065-60	60.0	+0.030 +0.150	65.0	60.0	60.150	60.030	65.030	65.000	60.000	59.926
TSM-6570-50	65.0	+0.030 +0.150	70.0	50.0	65.150	65.030	70.030	70.000	65.000	64.926
TSM-7075-70	70.0	+0.030 +0.150	75.0	70.0	70.150	70.030	75.030	75.000	70.000	69.926

iglide® T500
Sleeve - MM

PDF: www.igus.com/iglide-pdfs
CAD: www.igus.com/iglide-CAD
RoHS info: www.igus.com/RoHS

T500



iglide® Plain Bearings T500 - Flange, MM

iglide® T500
Flange - MM

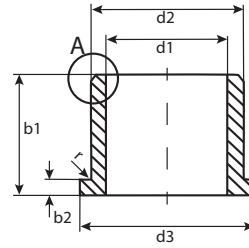
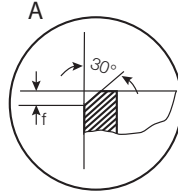

For tolerance values
please refer to page 13.4

r = max. 0.5

Dimensions according to ISO 3547-1 and special dimensions

Part Number	d1 ¹⁾ After Pressfit in Ø H7	d1-Tolerance +0.006 +0.046	d2	d3 d13	b1 h13	b2 -0.14	I.D. After Pressfit		Housing Bore		Shaft Size	
							Max.	Min.	Max.	Min.	Max.	Min.
TFM-0304-05	3.0	+0.006 +0.046	4.5	7.5	5.0	0.75	3.046	3.006	4.512	4.500	3.000	2.975
TFM-0405-04	4.0	+0.010 +0.058	5.5	9.5	4.0	0.75	4.058	4.010	5.512	5.500	4.000	3.970
TFM-0405-06	4.0	+0.010 +0.058	5.5	9.5	6.0	0.75	4.058	4.010	5.512	5.500	4.000	3.970
TFM-040508-06	4.0	+0.010 +0.058	5.5	8.0	6.0	0.75	4.058	4.010	5.512	5.500	4.000	3.970
TFM-0507-05	5.0	+0.010 +0.058	7.0	11.0	5.0	1.0	5.058	5.010	7.015	7.000	5.000	4.970
TFM-0608-08	6.0	+0.010 +0.058	8.0	12.0	8.0	1.0	6.058	6.010	8.015	8.000	6.000	5.970
TFM-0608-10	6.0	+0.010 +0.058	8.0	12.0	10.0	1.0	6.058	6.010	8.015	8.000	6.000	5.970
TFM-060812-20	6.0	+0.010 +0.058	8.0	12.0	20.0	1.0	6.058	6.010	8.015	8.000	6.000	5.970
TFM-081012-04	8.0	+0.013 +0.071	10.0	12.0	4.0	1.0	8.071	8.013	10.015	10.000	8.000	7.964
TFM-0810-05	8.0	+0.013 +0.071	10.0	15.0	5.0	1.0	8.071	8.013	10.015	10.000	8.000	7.964
TFM-0810-075	8.0	+0.013 +0.071	10.0	15.0	7.5	1.0	8.071	8.013	10.015	10.000	8.000	7.964
TFM-0810-08	8.0	+0.013 +0.071	10.0	15.0	8.0	1.0	8.071	8.013	10.015	10.000	8.000	7.964
TFM-0810-09	8.0	+0.013 +0.071	10.0	15.0	9.0	1.0	8.071	8.013	10.015	10.000	8.000	7.964
TFM-081117-05	8.0	+0.013 +0.071	11.0	17.0	5.0	1.5	8.071	8.013	11.015	11.000	8.000	7.964
TFM-1012-06	10.0	+0.013 +0.071	12.0	18.0	6.0	1.0	10.071	10.013	12.018	12.000	10.000	9.964
TFM-1012-08	10.0	+0.013 +0.071	12.0	15.0	8.0	1.0	10.071	10.013	12.018	12.000	10.000	9.964
TFM-1012-09	10.0	+0.013 +0.071	12.0	18.0	9.0	1.0	10.071	10.013	12.018	12.000	10.000	9.964
TFM-1012-15	10.0	+0.013 +0.071	12.0	18.0	15.0	1.0	10.071	10.013	12.018	12.000	10.000	9.964
TFM-1012-18	10.0	+0.013 +0.071	12.0	18.0	18.0	1.0	10.071	10.013	12.018	12.000	10.000	9.964
TFM-1012-22	10.0	+0.013 +0.071	12.0	18.0	22.0	1.0	10.071	10.013	12.018	12.000	10.000	9.964
TFM-1214-05	12.0	+0.016 +0.086	14.0	20.0	5.5	1.0	12.086	12.016	14.018	14.000	12.000	11.957
TFM-1214-09	12.0	+0.016 +0.086	14.0	20.0	9.0	1.0	12.086	12.016	14.018	14.000	12.000	11.957
TFM-1214-12	12.0	+0.016 +0.086	14.0	20.0	12.0	1.0	12.086	12.016	14.018	14.000	12.000	11.957
TFM-1214-15	12.0	+0.016 +0.086	14.0	20.0	15.0	1.0	12.086	12.016	14.018	14.000	12.000	11.957
TFM-1416-10	14.0	+0.016 +0.086	16.0	22.0	10.0	1.0	14.086	14.016	16.018	16.000	14.000	13.957
TFM-1416-12	14.0	+0.016 +0.086	16.0	22.0	12.0	1.0	14.086	14.016	16.018	16.000	14.000	13.957
TFM-1416-17	14.0	+0.016 +0.086	16.0	22.0	17.0	1.0	14.086	14.016	16.018	16.000	14.000	13.957
TFM-1517-12	15.0	+0.016 +0.086	17.0	23.0	12.0	1.0	15.086	15.016	17.018	17.000	15.000	14.957
TFM-1517-17	15.0	+0.016 +0.086	17.0	23.0	17.0	1.0	15.086	15.016	17.018	17.000	15.000	14.957
TFM-1618-12	16.0	+0.016 +0.086	18.0	24.0	12.0	1.0	16.086	16.016	18.018	18.000	16.000	15.957
TFM-1618-17	16.0	+0.016 +0.086	18.0	24.0	17.0	1.0	16.086	16.016	18.018	18.000	16.000	15.957
TFM-1820-12	18.0	+0.016 +0.086	20.0	26.0	12.0	1.0	18.086	18.016	20.021	20.000	18.000	17.957
TFM-1820-17	18.0	+0.016 +0.086	20.0	26.0	17.0	1.0	18.086	18.016	20.021	20.000	18.000	17.957
TFM-2023-075	20.0	+0.020 +0.104	23.0	30.0	7.5	1.5	20.104	20.020	23.021	23.000	20.000	19.948
TFM-2023-11	20.0	+0.020 +0.104	23.0	30.0	11.0	1.5	20.104	20.020	23.021	23.000	20.000	19.948
TFM-2023-16	20.0	+0.020 +0.104	23.0	30.0	16.0	1.5	20.104	20.020	23.021	23.000	20.000	19.948
TFM-2023-21	20.0	+0.020 +0.104	23.0	30.0	21.0	1.5	20.104	20.020	23.021	23.000	20.000	19.948
TFM-252833-08	25.0	+0.020 +0.104	28.0	33.0	8.0	1.5	25.104	25.020	28.021	28.000	25.000	24.948
TFM-2528-13	25.0	+0.020 +0.104	28.0	35.0	13.5	1.5	25.104	25.020	28.021	28.000	25.000	24.948
TFM-2528-21	25.0	+0.020 +0.104	28.0	35.0	21.0	1.5	25.104	25.020	28.021	28.000	25.000	24.948

Telephone 1-800-521-2747
Fax 1-401-438-7270

Internet: <http://www.igus.com>
email: sales@igus.com
QuickSpec: <http://www.igus.com/iglide-quickspec>

iglide® Plain Bearings T500 - Flange, MM

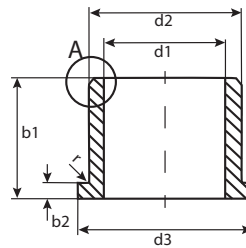
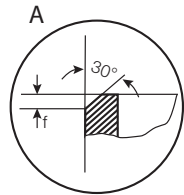

For tolerance values
please refer to page 13.4

r = max. 0.5

Dimensions according to ISO 3547-1 and special dimensions

Part Number	d1 ¹⁾		d2	d3	b1	b2	I.D. After Pressfit		Housing Bore		Shaft Size	
	After Pressfit in Ø H7						Max.	Min.	Max.	Min.	Max.	Min.
TFM-2730-20	27.0	+0.020 +0.104	30.0	38.0	20.0	1.5	27.104	27.020	30.021	30.000	27.000	26.948
TFM-2834-44	28.0	+0.020 +0.104	34.0	42.0	44.0	2.0	28.104	28.020	34.021	34.000	28.000	27.948
TFM-3034-16	30.0	+0.020 +0.104	34.0	42.0	16.0	2.0	30.104	30.020	34.025	34.000	30.000	29.948
TFM-3034-26	30.0	+0.020 +0.104	34.0	42.0	26.0	2.0	30.104	30.020	34.025	34.000	30.000	29.948
TFM-3034-40	30.0	+0.020 +0.104	34.0	42.0	40.0	2.0	30.104	30.020	34.025	34.000	30.000	29.948
TFM-3236-15	32.0	+0.025 +0.125	36.0	45.0	15.0	2.0	32.125	32.025	36.025	36.000	32.000	31.938
TFM-3236-26	32.0	+0.025 +0.125	36.0	45.0	26.0	2.0	32.125	32.025	36.025	36.000	32.000	31.938
TFM-3539-26	35.0	+0.025 +0.125	39.0	47.0	26.0	2.0	35.125	35.025	39.025	39.000	35.000	34.938
TFM-4044-22	40.0	+0.025 +0.125	44.0	52.0	22.0	2.0	40.125	40.025	44.025	44.000	40.000	39.938
TFM-4044-30	40.0	+0.025 +0.125	44.0	52.0	30.0	2.0	40.125	40.025	44.025	44.000	40.000	39.938
TFM-4044-40	40.0	+0.025 +0.125	44.0	52.0	40.0	2.0	40.125	40.025	44.025	44.000	40.000	39.938
TFM-4550-50	45.0	+0.025 +0.125	50.0	58.0	50.0	2.0	45.125	45.025	50.025	50.000	45.000	44.938
TFM-5055-40	50.0	+0.025 +0.125	55.0	63.0	40.0	2.0	50.125	50.025	55.030	55.000	50.000	49.938
TFM-6065-40	60.0	+0.030 +0.150	65.0	73.0	40.0	2.0	60.150	60.030	65.030	65.000	60.000	59.926
TFM-7075-40	70.0	+0.030 +0.150	75.0	83.0	40.0	2.0	70.150	70.030	75.030	75.000	70.000	69.926
TFM-7580-50	75.0	+0.030 +0.150	80.0	88.0	50.0	2.0	75.150	75.030	80.030	80.000	75.000	74.926

iglide® T500
Flange - MM

PDF: www.igus.com/iglide-pdfs
CAD: www.igus.com/iglide-CAD
RoHS info: www.igus.com/RoHS

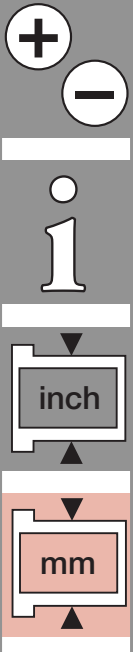

T500

iglus®

iglide® Plain Bearings

T500 - Thrust Washer, MM

iglide® T500
Thrust Washer - MM

Telephone 1-800-521-2747
Fax 1-401-438-7270

Internet: <http://www.igus.com>
email: sales@igus.com
QuickSpec: <http://www.igus.com/iglide-quickspec>

13.16

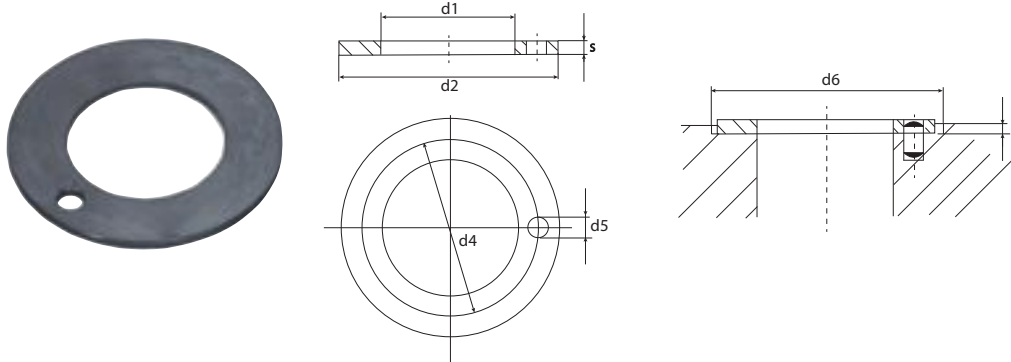

Dimensions according to ISO 3547-1 and special dimensions

Part Number	d1 +0,25	d2 -0,25	s -0,05	d4 -0,12 +0,12	d5 +0,375 +0,125	h +0,2 -0,2	d6 +0,12
TTM-0620-015	6.0	20.0	1.5	13.0	1.5	1.0	20.0
TTM-0818-015	8.0	18.0	1.5	13.0	1.5	1.0	18.0
TTM-1018-010	10.0	18.0	1.0	**	**	.7	18.0
TTM-1224-015	12.0	24.0	1.5	18.0	1.5	1.0	24.0
TTM-1426-015	14.0	26.0	1.5	20.0	2.0	1.0	26.0
TTM-1524-015	15.0	24.0	1.5	19.5	1.5	1.0	24.0
TTM-1630-015	16.0	30.0	1.5	22.0	2.0	1.0	30.0
TTM-1832-015	18.0	32.0	1.5	25.0	2.0	1.0	32.0
TTM-2036-015	20.0	36.0	1.5	28.0	3.0	1.0	36.0
TTM-2238-015	22.0	38.0	1.5	30.0	3.0	1.0	38.0
TTM-2442-015	24.0	42.0	1.5	33.0	3.0	1.0	42.0
TTM-2644-015	26.0	44.0	1.5	35.0	3.0	1.0	44.0
TTM-2848-015	28.0	48.0	1.5	38.0	4.0	1.0	48.0
TTM-3254-015	32.0	54.0	1.5	43.0	4.0	1.0	54.0
TTM-3862-015	38.0	62.0	1.5	50.0	4.0	1.0	62.0
TTM-4266-015	42.0	66.0	1.5	84.0	4.0	1.0	66.0
TTM-4874-020	48.0	74.0	2.0	61.0	4.0	1.5	74.0
TTM-5278-020	52.0	78.0	2.0	65.0	4.0	1.5	78.0
TTM-6290-020	62.0	90.0	2.0	76.0	4.0	1.5	90.0

** Designed without fixing bore

igus[®]



iglide[®] X6

Product Range

- Standard Styles:
Sleeve, Flange
- Custom shapes and sizes available
- Inner diameters:
Inch sizes from 1/8 - 1-1/2"
Metric sizes from 3 - 40 mm

Part Number Structure

Part Number Structure

X6 S I - 03 04 - 05

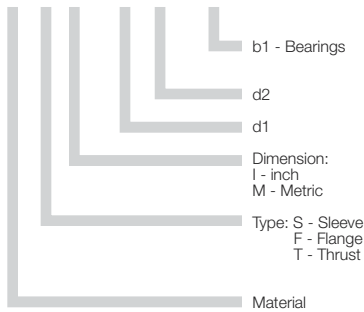

Permissible Surface Speeds

	Continuous fpm	Short Term fpm
Rotating	1.5	3.5
Oscillating	1.1	2.5
Linear	5	10

Usage Guidelines



- If temperatures are higher than 302°F
- When the wear performance of iglide® T500 in oscillation is not sufficient
- When the amount of pressfit required exceeds iglide® T500



- When you need a cost effective universal bearing
➤ iglide® G300
- If you need a bearing for underwater use
➤ iglide® H370
➤ iglide® UW500
- When a wear-resistant high-temperature bearing for linear movements is needed
➤ iglide® Z



Visit www.igus.com to use our online expert system

Material Table

General Properties	Unit	iglide® X6	Testing Method
Density	g/cm ³	1.53	
Color		blue grey	
Max. moisture absorption at 73°F / 50% r.h.	% weight	0.1	DIN 53495
Max. moisture absorption	% weight	0.5	
Coefficient of friction, dynamic against steel	μ	0.09 - 0.25	
p x v value, max. (dry)	psi x fpm	38,350	

Mechanical Properties

Modulus of elasticity	psi	2,320,600	DIN 53457
Tensile strength at 68°F	psi	42,060	DIN 53452
Compressive strength	psi	27,557	
Permissible static surface pressure (68°F)	psi	21,755	
Shore D-hardness		89	DIN 53505

Physical and Thermal Properties

Max. long-term application temperature	°F	482	
Max. application temperature, short-term	°F	599	
Min. application temperature	°F	-148	
Thermal conductivity	W/m x K	0.55	ASTM C 177
Coefficient of thermal expansion	K ⁻¹ x 10 ⁻⁵	1	DIN 53752

Electrical Properties

Specific volume resistance	Ωcm	> 10 ⁵	DIN IEC 93
Surface resistance	Ω	> 10 ⁵	DIN 53482

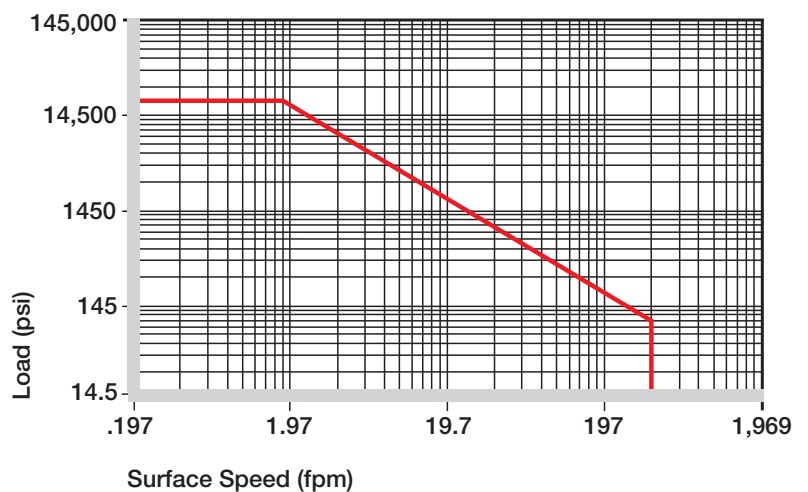

Graph 13.1: Permissible p x v value for iglide® M250 running dry against a steel shaft, at 68°F

iglide® X6 bearing runs up to 6 times longer than the iglide® T500. Thanks to nano-technology, iglide® X6 shows an up to six times better performance than iglide® T500 in many oscillating and rotating applications - even at temperatures over 212°F.

Compressive Strength

The recommended maximum surface pressure is a mechanical material parameter. No conclusions regarding the tribological properties can be drawn from this. With increasing temperatures, the compressive strength of iglide® X6 plain bearings decreases.

Graph 13.2 at the right shows the elastic deformation of iglide® X6 during radial loading. At the recommended maximum surface pressure of 290 psi the deformation is less than 2%.

► Compressive Strength, Page 1.3

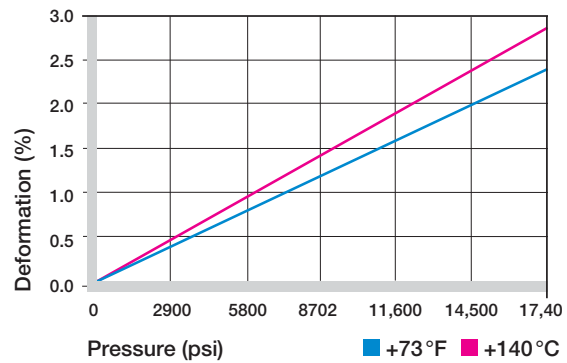

Graph 13.2: Deformation under load and temperature

Permissible Surface Speeds

Due to the high temperature resistance and good thermal conductivity, iglide® X6 is also suitable for high speed applications. At the given speeds, friction can cause a temperature increase to maximum permissible levels. In practice, this temperature is rarely reached due to varying application conditions.

► Surface Speed, Page 1.5
 ► $\rho \times v$ Value, Page 1.6

	Continuous fpm	Short Term fpm
Rotating	295	689
Oscillating	216	492
Linear	984	1969

Maximum surface speeds

Temperatures

The surrounding temperatures noticeably influence the wear performance of plastic bearings. The temperature resistance of iglide® X6 is among the highest in the iglide® range.

In many tests it has shown a six times higher wear performance compared to the established high-temperature bearing iglide® T500. Another advantage to iglide® X6 is that axial securing is only necessary at temperatures above 320°F.

► Application Temperatures, Page 1.7

iglide® T500	Application Temperature
Minimum	- 148 °F
Max., long-term	+ 482 °F
Max., short-term	+ 599 °F
Add. securing is required from	+ 329°F

Temperature limits for iglide® X6

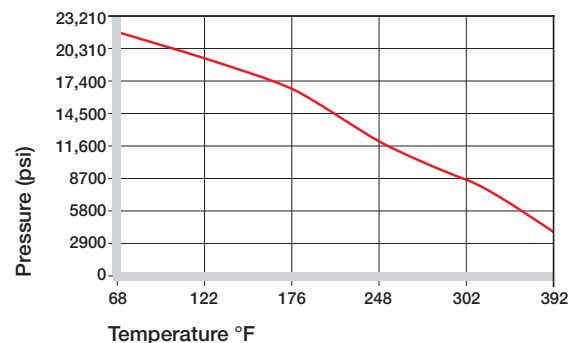

Graph 13.3: Recommended maximum permissible static surface pressure of iglide® X6 as a result of temperature (21,760 psi at +68°F)

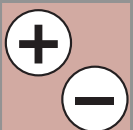

Installation Tolerances

iglide® X6 plain bearings are oversized before being pressfit. After proper installation into a recommended housing bore, the inner diameter adjusts to meet our specified tolerances. Please adhere to the catalog specifications for housing bore and recommended shaft sizes. This will help to ensure optimal performance of iglide® plain bearings.

- ▶ See Tolerance Table, Page 1.14
- ▶ Testing Methods, Page 1.15

For Inch Size Bearings		
Length Tolerance (b1)	Length of Chamfer (f)	
Length (inches)	Tolerance (h13) (inches)	Based on d1
0.1181 to 0.2362	-0.0000 /-0.0071	f = .012 → d ₁ .040" - .236"
0.2362 to 0.3937	-0.0000 /-0.0087	f = .019 → d ₁ > .236" - .472"
0.3937 to 0.7086	-0.0000 /-0.0106	f = .031 → d ₁ > .472" - 1.18"
0.7086 to 1.1811	-0.0000 /-0.0130	f = .047 → d ₁ > 1.18"
1.1811 to 1.9685	-0.0000 /-0.0154	
1.9685 to 3.1496	-0.0000 /-0.0181	

For Metric Size Bearings		
Length Tolerance (b1)	Length of Chamfer (f)	
Length (mm)	Tolerance (h13) (µm)	Based on d1
1 to 3	-0 /-140	f = 0.3 → d ₁ 1 - 6 mm
> 3 to 6	-0 /-180	f = 0.5 → d ₁ > 6 - 12 mm
> 6 to 10	-0 /-220	f = 0.8 → d ₁ > 12 - 30 mm
> 10 to 18	-0 /-270	
> 18 to 30	-0 /-330	
> 30 to 50	-0 /-390	
> 50 to 80	-0 /-460	

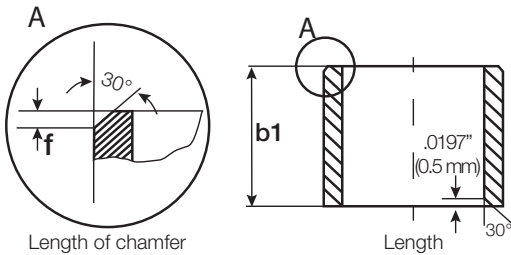

Friction and Wear

Similar to wear resistance, the coefficient of friction μ also changes with the load. The coefficient of friction of iglide® X6 declines with higher pressure and is practically constant for pressure above 4,350 psi. A higher speed of the shaft also results in a lower coefficient of friction (graphs 13.4 and 13.5). The best performance is achieved with the plain shaft materials free cutting steel and plain steel 1.0037. At higher loads, we recommend harder steel qualities. Non-hardened steel shafts can be worn by the bearing at pressure over 290 psi.

The wear database shows that iglide® X6 is more suitable for rotating than for oscillating applications. If the shaft material you plan on using is not shown in these test results, please contact us.

- ▶ Coefficients of friction and surfaces, Page 1.8
- ▶ Wear resistance, Page 1.9

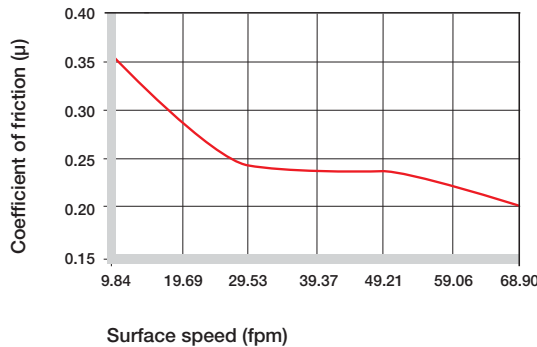

Graph 13.4: Coefficient of friction for iglide® X6 as a result of the running speed; p = 109 psi

iglide® T500	Coefficient of Friction
Dry	0.08 - 0.15
Grease	0.09
Oil	0.04
Water	0.04

Table 13.4: Coefficient of friction for iglide® X6 against steel (Shaft finish = 40 rms, 50 HRC)

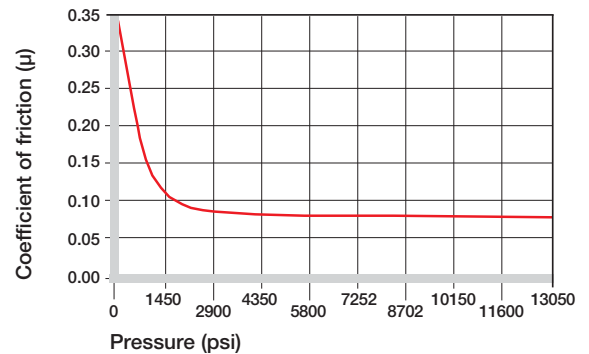

Graph 13.5: Coefficient of friction as a function of the pressure, v = (0.01 m/s) fpm

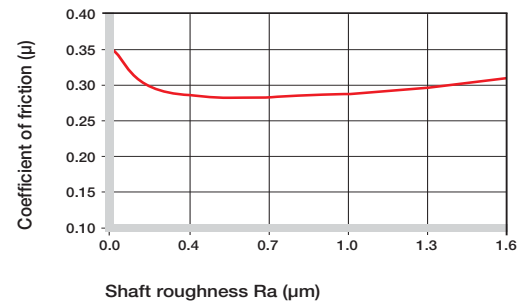

Graph 13.6: Coefficients of friction as a function of the shaft surface (cf53 hardened and ground steel)

Shaft Materials

The friction and wear are also dependent, to a large degree, on the shaft material. Shafts that are too smooth, increase both the coefficient of friction and the wear of the bearing. The best case for iglide® X6 is a ground surface with an average roughness $R_a = 0.4 - 0.7 \mu\text{m}$ (Graph 13.6). Graphs 13.7 and 13.9 show results of testing different shaft materials with plain bearings made of iglide® X6. In Graph 13.7 it shows that iglide® X6 can be combined with various shaft materials

► Shaft Materials, Page 1.11

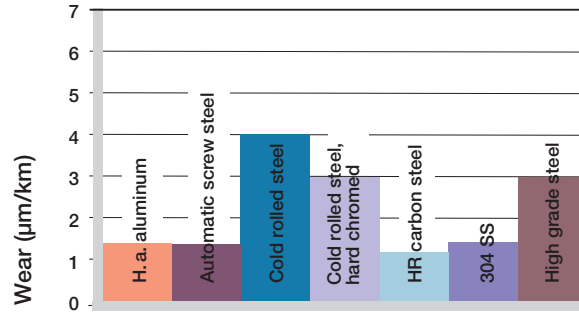

Graph 13.7: Wear rotating with different shaft materials, $p = 145 \text{ psi}$, $v = 59 \text{ fpm}$

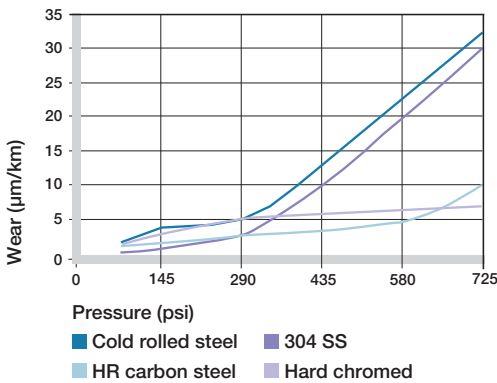

Graph 13.8: Wear with different shaft materials in rotational operation, as a function of the pressure

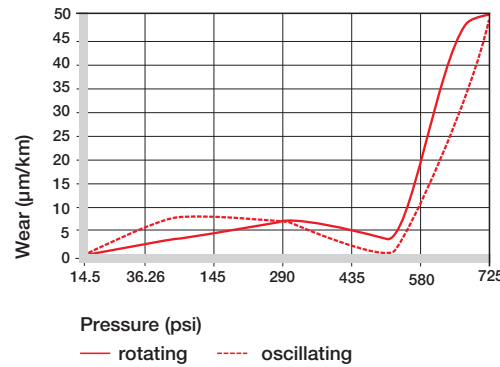

Graph 13.9: Wear for oscillating and rotating applications with shaft materials c53 hardened and ground steel, as a function of the pressure

Chemical Resistance

iglide® T500 plain bearings have almost universal chemical resistance. They are only affected by concentrated nitric acid and sulfuric acid. Due to the low water absorption, the material can be used in humid environments without problems. iglide® X6 is resistant to most typical detergents used in the food and packaging industries.

► Chemicals Table, Page 1.16

Medium	Resistance
Alcohol	+
Hydrocarbons, chlorinated	+
Greases, oils without additives	+
Fuels	+
Weak acids	+
Strong acids	+
Weak alkaline	+
Strong alkaline	+

+ resistant, 0 conditionally resistant, - not resistant

Chemical resistance of iglide® X6

All data given concerns the chemical resistance at room temperature (68°F). For a complete list, see page 1.16

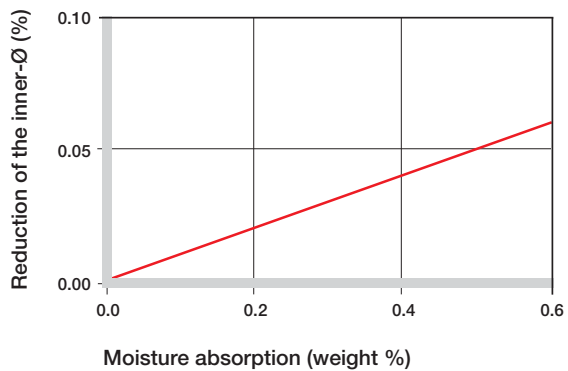

Graph 13.10: Effect of moisture absorption on iglide® X6 plain bearings



iglide® X6

Telephone 1-800-521-2747
Fax 1-401-438-7270

Internet: <http://www.igus.com>
email: sales@igus.com
QuickSpec: <http://www.igus.com/iglide-quickspec>

Radiation Resistance

Plain bearings made from iglide® X6 are resistant to radiation up to an intensity of 2×10^5 Gy.

UV Resistance

Partially resistant against UV rays

Vacuum

In a vacuum environment, iglide® X6 plain bearings can be used virtually without restrictions. Outgassing takes place to a very limited extent.

Electrical Properties

iglide® X6 plain bearings are electrically conductive.

iglide® X6

Specific volume resistance	< $10^5 \Omega\text{cm}$
Surface Resistance	< $10^5 \Omega$

Table 13.6: Electrical properties of iglide® X6

iglide® Plain Bearings X6 - Sleeve, Inch

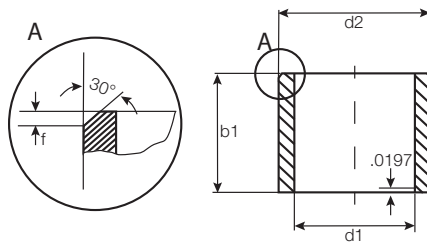

For tolerance values
please refer to page 13.4

iglide® X6
Sleeve - Inch

Part Number	d1	d2	b1	I.D. After Pressfit		Housing Bore		Shaft Size	
				Max.	Min.	Max.	Min.	Max.	Min.
X6SI-0203-03	1/8	3/16	3/16	.1269	.1251	.1878	.1873	.1243	.1236
X6SI-0304-04	3/16	1/4	1/4	.1892	.1873	.2503	.2497	.1865	.1858
X6SI-0405-04	1/4	5/16	1/4	.2521	.2498	.3128	.3122	.2490	.2481
X6SI-0506-06	5/16	3/8	3/8	.3148	.3125	.3753	.3747	.3115	.3106
X6SI-0607-06	3/8	15/32	3/8	.3773	.3750	.4691	.4684	.3740	.3731
X6SI-0708-08	7/16	17/32	1/2	.4406	.4379	.5316	.5309	.4365	.4355
X6SI-0809-08	1/2	19/32	1/2	.5030	.5003	.5941	.5934	.4990	.4980
X6SI-0809-10	1/2	19/32	5/8	.5030	.5003	.5941	.5934	.4990	.4980
X6SI-0809-12	1/2	19/32	3/4	.5030	.5003	.5941	.5934	.4990	.4980
X6SI-1011-10	5/8	23/32	5/8	.6280	.6253	.7192	.7184	.6240	.6230
X6SI-1214-08	3/4	7/8	1/2	.7541	.7507	.8755	.8747	.7491	.7479
X6SI-1214-12	3/4	7/8	3/4	.7541	.7507	.8755	.8747	.7491	.7479
X6SI-1214-16	3/4	7/8	1	.7541	.7507	.8755	.8747	.7491	.7479
X6SI-1416-16	7/8	1	1	.8791	.8757	1.0005	.9997	.8741	.8729
X6SI-1618-08	1	1 1/8	1/2	1.0041	1.0007	1.1255	1.1247	.9991	.9979
X6SI-1618-12	1	1 1/8	3/4	1.0041	1.0007	1.1255	1.1247	.9991	.9979
X6SI-1618-16	1	1 1/8	1	1.0041	1.0007	1.1255	1.1247	.9991	.9979
X6SI-2426-16	1 1/2	1 21/32	1	1.5048	1.5008	1.6568	1.6558	1.4988	1.4972
X6SI-2426-24	1 1/2	1 21/32	1 1/2	1.5048	1.5008	1.6568	1.6558	1.4988	1.4972

PDF: www.igus.com/iglide-pdfs
 CAD: www.igus.com/iglide-CAD
 RoHS info: www.igus.com/RoHS

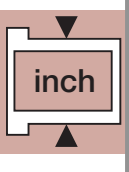

X6



iglide® Plain Bearings X6 - Flange, Inch

iglide® X6
Flange - Inch

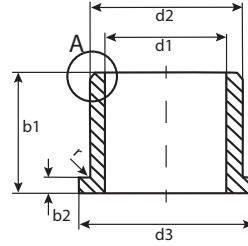
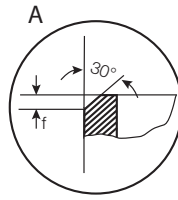

For tolerance values
please refer to page 14.4

r = max. .0197

Telephone 1-800-521-2747
Fax 1-401-438-7270

Part Number	d1	d2	b1	d3	b2 -.0055	I.D. After Pressfit		Housing Bore		Shaft Size	
						Max.	Min.	Max.	Min.	Max.	Min.
X6FI-0203-03	1/8	3/16	3/16	.312	.032	.1269	.1251	.1878	.1873	.1243	.1236
X6FI-0304-04	3/16	1/4	1/4	.375	.032	.1892	.1873	.2503	.2497	.1865	.1858
X6FI-0405-04	1/4	5/16	1/4	.500	.032	.2521	.2498	.3128	.3122	.2490	.2481
X6FI-0506-06	5/16	3/8	3/8	.562	.032	.3148	.3125	.3753	.3747	.3115	.3106
X6FI-0607-06	3/8	15/32	3/8	.687	.046	.3773	.3750	.4691	.4684	.3740	.3731
X6FI-0708-08	7/16	17/32	1/2	.750	.046	.4406	.4379	.5316	.5309	.4365	.4355
X6FI-0809-08	1/2	19/32	1/2	.875	.046	.5030	.5003	.5941	.5934	.4990	.4980
X6FI-0809-10	1/2	19/32	5/8	.875	.046	.5030	.5003	.5941	.5934	.4990	.4980
X6FI-0809-12	1/2	19/32	3/4	.875	.046	.5030	.5003	.5941	.5934	.4990	.4980
X6FI-1011-10	5/8	23/32	5/8	.937	.046	.6280	.6253	.7192	.7184	.6240	.6230
X6FI-1214-08	3/4	7/8	1/2	1.125	.062	.7541	.7507	.8755	.8747	.7491	.7479
X6FI-1214-12	3/4	7/8	3/4	1.125	.062	.7541	.7507	.8755	.8747	.7491	.7479
X6FI-1214-16	3/4	7/8	1	1.125	.062	.7541	.7507	.8755	.8747	.7491	.7479
X6FI-1416-16	7/8	1	1	1.250	.062	.8791	.8757	1.0005	.9997	.8741	.8729
X6FI-1618-08	1	1 1/8	1/2	1.375	.062	1.0041	1.0007	1.1255	1.1247	.9991	.9979
X6FI-1618-12	1	1 1/8	3/4	1.375	.062	1.0041	1.0007	1.1255	1.1247	.9991	.9979
X6FI-1618-16	1	1 1/8	1	1.375	.062	1.0041	1.0007	1.1255	1.1247	.9991	.9979
X6FI-2426-16	1 1/2	1 21/32	1	2.000	.078	1.5048	1.5008	1.6568	1.6558	1.4988	1.4972
X6FI-2426-24	1 1/2	1 21/32	1 1/2	2.000	.078	1.5048	1.5008	1.6568	1.6558	1.4988	1.4972

Internet: <http://www.igus.com>
email: sales@igus.com
QuickSpec: <http://www.igus.com/iglide-quickspec>

iglide® Plain Bearings X6 - Sleeve, MM

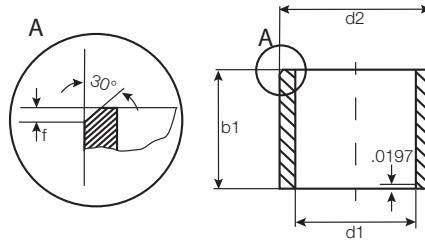

For tolerance values
please refer to page 14.4

Dimensions according to ISO 3547-1 and special dimensions

Part Number	d1	d1-Tolerance after pressfit in Ø H7	d2	b1 h13	I.D. After Pressfit		Housing Bore		Shaft Size	
					Max.	Min.	Max.	Min.	Max.	Min.
X6SM-0304-03	3.0	+0.006 +0.046	4.5	3.0	3.046	3.006	4.512	4.500	3.000	2.975
X6SM-0507-05	5.0	+0.010 +0.058	7.0	5.0	5.058	5.010	7.015	7.000	5.000	4.970
X6SM-0608-06	6.0	+0.010 +0.058	8.0	6.0	6.058	6.010	8.015	8.000	6.000	5.970
X6SM-0810-10	8.0	+0.013 +0.071	10.0	10.0	8.071	8.013	10.015	10.000	8.000	7.964
X6SM-1012-10	10.0	+0.013 +0.071	12.0	10.0	10.071	10.013	12.018	12.000	10.000	9.964
X6SM-1214-12	12.0	+0.016 +0.086	14.0	12.0	12.086	12.016	14.018	14.000	12.000	11.957
X6SM-1618-15	16.0	+0.016 +0.086	18.0	15.0	16.086	16.016	18.018	18.000	16.000	15.957
X6SM-2023-20	20.0	+0.020 +0.104	23.0	20.0	20.104	20.020	23.021	23.000	20.000	19.948
X6SM-2528-30	25.0	+0.020 +0.104	28.0	30.0	25.104	25.020	28.021	28.000	25.000	24.948
X6SM-3034-30	30.0	+0.020 +0.104	34.0	30.0	30.104	30.020	34.025	34.000	30.000	29.948
X6SM-3539-40	35.0	+0.025 +0.125	39.0	40.0	35.125	35.025	39.025	39.000	35.000	34.938
X6SM-4044-40	40.0	+0.025 +0.125	44.0	40.0	40.125	40.025	44.025	44.000	40.000	39.938

iglide® X6
Sleeve - MM

PDF: www.igus.com/iglide-pdfs
CAD: www.igus.com/iglide-CAD
RoHS info: www.igus.com/RoHS

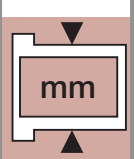
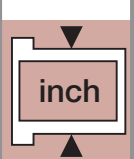

X6



iglide® Plain Bearings X6 - Flange, MM

iglide® X6
Flange - MM

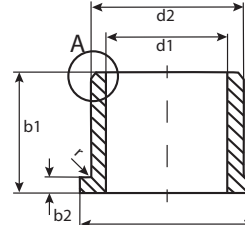
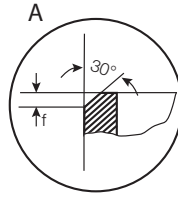

For tolerance values
please refer to page 14.4

r = max. 0.5

Dimensions according to ISO 3547-1 and special dimensions

Part Number	d1 ¹⁾ After Pressfit in Ø H7	d1-Tolerance +0.006 +0.046	d2	d3 d13	b1 h13	b2 -0.14	I.D. After Pressfit		Housing Bore		Shaft Size	
							Max.	Min.	Max.	Min.	Max.	Min.
TFM-0304-05	3.0	+0.006 +0.046	4.5	7.5	5.0	0.75	3.046	3.006	4.512	4.500	3.000	2.975
TFM-0507-05	5.0	+0.010 +0.058	7.0	11.0	5.0	1.0	5.058	5.010	7.015	7.000	5.000	4.970
TFM-0608-06	6.0	+0.010 +0.058	8.0	12.0	8.0	1.0	6.058	6.010	8.015	8.000	6.000	5.970
TFM-0810-10	8.0	+0.013 +0.071	10.0	15.0	9.0	1.0	8.071	8.013	10.015	10.000	8.000	7.964
TFM-1012-10	10.0	+0.013 +0.071	12.0	18.0	9.0	1.0	10.071	10.013	12.018	12.000	10.000	9.964
TFM-1214-12	12.0	+0.016 +0.086	14.0	20.0	12.0	1.0	12.086	12.016	14.018	14.000	12.000	11.957
TFM-1618-17	16.0	+0.016 +0.086	18.0	24.0	17.0	1.0	16.086	16.016	18.018	18.000	16.000	15.957
TFM-2023-21	20.0	+0.020 +0.104	23.0	30.0	21.0	1.5	20.104	20.020	23.021	23.000	20.000	19.948
TFM-2528-21	25.0	+0.020 +0.104	28.0	35.0	21.0	1.5	25.104	25.020	28.021	28.000	25.000	24.948
TFM-3034-40	30.0	+0.020 +0.104	34.0	42.0	40.0	2.0	30.104	30.020	34.025	34.000	30.000	29.948
TFM-3539-26	35.0	+0.025 +0.125	39.0	47.0	26.0	2.0	35.125	35.025	39.025	39.000	35.000	34.938
TFM-4044-40	40.0	+0.025 +0.125	44.0	52.0	40.0	2.0	40.125	40.025	44.025	44.000	40.000	39.938

Telephone 1-800-521-2747
Fax 1-401-438-7270

Internet: <http://www.igus.com>
email: sales@igus.com
QuickSpec: <http://www.igus.com/iglide-quickspec>



iglide® Plain Bearings
X6 - Notes

iglide® X6

Telephone 1-800-521-2747
Fax 1-401-438-7270

Internet: <http://www.igus.com>
email: sales@igus.com
QuickSpec: <http://www.igus.com/iglide-quickspec>

igus[®]



iglide[®] Z



Product Range

- Standard Styles:
Sleeve, Flange and Thrust Washer
- Custom shapes and sizes available
- Inner diameters:
Inch sizes from 1/8 - 2-1/4 in.
Metric sizes from 4 - 75 mm

Part Number Structure

Part Number Structure

Z S I - 02 03 - 03

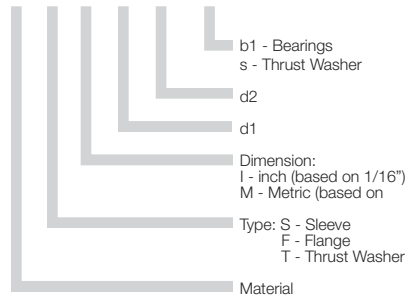

Permissible Surface Speeds

	Continuous fpm	Short Term fpm
Rotating	295	689
Oscillating	216	492
Linear	984	1181

Usage Guidelines



- For continuous temperatures up to 482°F
- For high radial loads and high temperature
- For high surface speeds
- For edge loading in connection with high surface pressures



- For low loads and temperatures
➤ iglide® P
- When a cost effective all-around bearing is sought
➤ iglide® G300
- When electrically conductive bearings are needed
➤ iglide® F



Visit www.igus.com
to use our online
expert system

Material Data

General Properties	Unit	iglide® Z	Testing Method
Density	g/cm ³	1.40	
Color		brown	
Max. moisture absorption at 73°F/ 50% r.h.	% weight	0.3	DIN 53495
Max. moisture absorption	% weight	1.1	
Coefficient of friction, dynamic against steel	μ	0.06 - 0.14	
p x v value, max. (dry)	psi x fpm	24,000	

Mechanical Properties

Modulus of elasticity	psi	348,000	DIN 53457
Tensile strength at 68°F	psi	13,775	DIN 53452
Compressive strength	psi	9,425	
Permissible static surface pressure (68°F)	psi	21,750	
Shore D-hardness		81	DIN 53505

Physical and Thermal Properties

Max. long-term application temperature	°F	482	
Max. short-term application temperature	°F	590	
Minimum application temperature	°F	-148	
Thermal conductivity	W/m x K	0.62	ASTM C 177
Coefficient of thermal expansion	K ⁻¹ x 10 ⁻⁵	4	DIN 53752

Electrical Properties

Specific volume resistance	Ωcm	> 10 ¹¹	DIN IEC 93
Surface resistance	Ω	> 10 ¹¹	DIN 53482

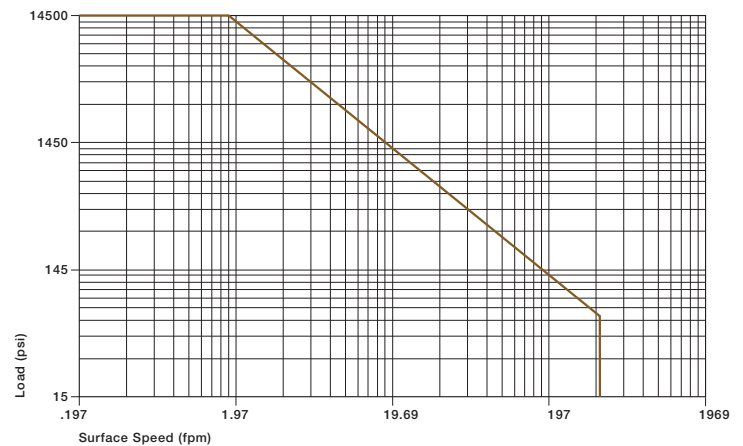

Graph 15.1: Permissible p x v values for iglide® Z running dry against a steel shaft, at 68°F

Compressive Strength

Igilde® Z is a high-temperature bearing material, which is suited for applications with very high specific loads. For radial pressures between 7,250 and 14,500 psi, there is no better dry running wear-resistant iglide® material. Graph 15.2 shows the elastic deformation of iglide® Z for radial loads. At the maximum permissible load of 14,500, the deformation is approximately 5.5% at room temperature.

➤ Compressive Strength, Page 1.3

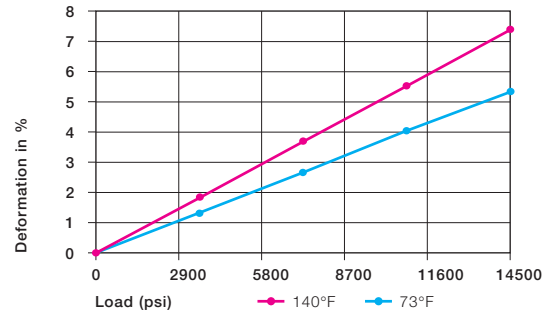

Graph 15.2: Deformation under load and temperature

Permissible Surface Speeds

Igilde® Z is suited for both average and high speeds due to its high thermal resistance. The maximum values given in Table 15.2 can only be achieved at the lowest pressure loads. At the given speeds, friction can cause temperature to increase to maximum permissible levels.

➤ Surface Speed, Page 1.5

➤ $p \times v$ value, Page 1.6

	Continuous fpm	Short Term fpm
Rotating	295	689
Oscillating	216	492
Linear	984	1181

Table 15.2: Maximum surface speed

Temperatures

The maximum permissible short-term temperature is 590°F. This represents the highest thermal resistance of any iglide® material. With increasing temperatures, the compressive strength of iglide® Z plain bearings decreases. Graph 15.3 shows this relationship. The ambient temperatures prevalent in the bearing system also have an effect on the bearing wear. With increasing temperatures, the wear increases.

Graph 15.4 shows that when the temperature increases from room temperature to 302°F, the wear of iglide® Z only doubles. At high temperatures, iglide® Z is also the most wear-resistant material while running dry.

➤ Application Temperatures, Page 1.7

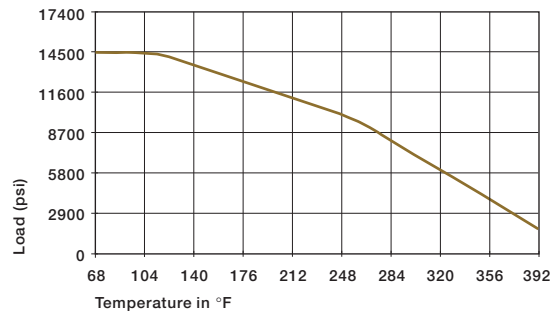

Graph 15.3: Recommended maximum permissible static surface pressure of iglide® Z as a result of the temperature

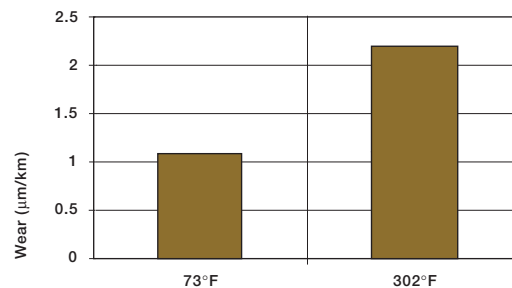

Graph 15.4: Wear of iglide® Z as a result of temperature, rotation with $p = 108$ psi, $v = 98$ fpm, (shaft Cold Rolled Steel)

iglide® Z	Application Temperature
Minimum	- 148°F
Max. long-term	+ 482°F
Max. short-term	+ 590°F

Table 15.3: Temperature limits for iglide® Z



iglide® Plain Bearings Z - Technical Data

iglide® Z

Telephone 1-800-521-2747
Fax 1-401-438-7270

Internet: <http://www.igus.com>
email: sales@igus.com
QuickSpec: <http://www.igus.com/iglide-quickspec>

Installation Tolerances

iglide® Z plain bearings are oversized before being pressfit. After proper installation into a recommended housing bore, the inner diameter adjusts to meet our specified tolerances. Please adhere to the catalog specifications for housing bore and recommended shaft sizes. This will help to ensure optimal performance of iglide® plain bearings.

- ▶ See Tolerance Table, Page 1.14
- ▶ Testing Methods, Page 1.15

For Inch Size Bearings		
Length Tolerance (b1)	Length of Chamfer (f)	
Length (inches)	Tolerance (h13) (inches)	Based on d1
0.1181 to 0.2362	-0.0000 /-0.0071	f = .012 → d ₁ .040" - .236"
0.2362 to 0.3937	-0.0000 /-0.0087	f = .019 → d ₁ > .236" - .472"
0.3937 to 0.7086	-0.0000 /-0.0106	f = .031 → d ₁ > .472" - 1.18"
0.7086 to 1.1811	-0.0000 /-0.0130	f = .047 → d ₁ > 1.18"
1.1811 to 1.9685	-0.0000 /-0.0154	
1.9685 to 3.1496	-0.0000 /-0.0181	

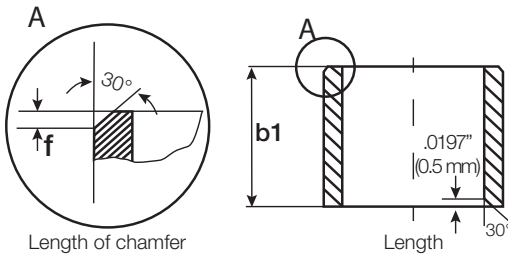

For Metric Size Bearings		
Length Tolerance (b1)	Length of Chamfer (f)	
Length (mm)	Tolerance (h13) (µm)	Based on d1
1 to 3	-0 /-140	f = 0.3 → d ₁ 1 - 6 mm
> 3 to 6	-0 /-180	f = 0.5 → d ₁ > 6 - 12 mm
> 6 to 10	-0 /-220	f = 0.8 → d ₁ > 12 - 30 mm
> 10 to 18	-0 /-270	f = 1.2 → d ₁ > 30 mm
> 18 to 30	-0 /-330	
> 30 to 50	-0 /-390	
> 50 to 80	-0 /-460	

Friction and Wear

Similar to wear resistance, the coefficient of friction only changes slightly with increasing load. Friction and wear are also dependent, to a large degree, on the shaft partner. Shafts that are too smooth increase both the coefficient of friction and the wear of the bearing. iglide® Z proves to be relatively resistant in regard to the shaft surface. For iglide® Z a ground surface with an average roughness range of 16-32 rms is recommended for the shaft.

- ▶ Coefficients of Friction and Surfaces, Page 1.8
- ▶ Wear Resistance, Page 1.9

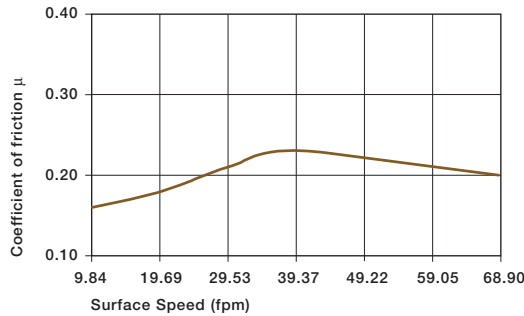

Graph 15.5: Coefficients of friction of iglide® Z as a result of the running speed; p = 108 psi

iglide® Z	Coefficient of Friction
Dry	0.06 - 0.14
Grease	0.09
Oil	0.04
Water	0.04

Table 15.4: Coefficients of friction for iglide® Z against steel (Shaft finish = 40 rms, 50 HRC)

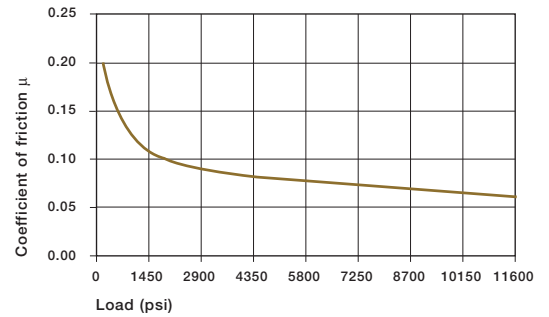

Graph 15.6: Coefficients of friction of iglide® Z as a result of the load, v = 1.97 fpm

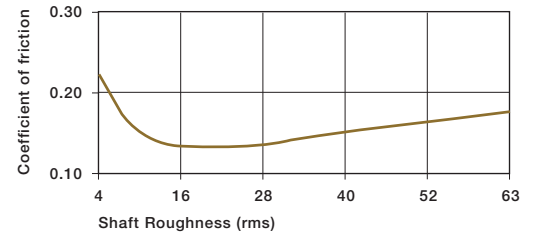

Graph 15.7: Coefficients of friction of iglide® Z as a result of the shaft surface (shaft Cold Rolled Steel)

Shaft Materials

The diagrams show wear rates in the lower load range, which are very similar to those of other iglide® materials. In the upper range on the other hand, iglide® Z outperforms all other materials in wear resistance. Provided a Cold Rolled Steel shaft is used, the wear at 6525 psi is still only 15 µm/km.

For low loads, iglide® Z plain bearings wear in oscillating operation less than in rotation. 303 Stainless Steel and hard-chromed shaft are of interest here. The value 0.5 µm/km shows 303 Stainless provides the lowest wear in oscillating movements at 280 psi. For higher loads, hard-chromed shafts outperform 303 Stainless. However even at 14,500 psi, iglide® Z obtains excellent wear values. If the shaft material you plan to use is not contained in this list, please contact us.

► Shaft Materials, Page 1.11

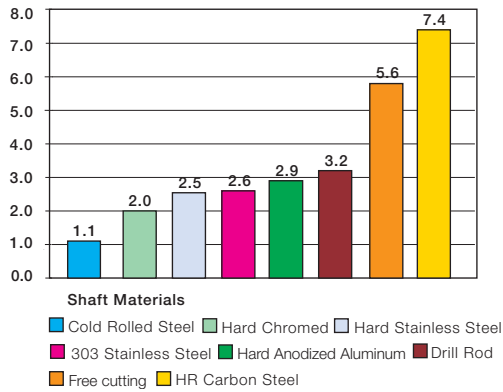

Graph 15.8: Wear of iglide® Z rotating applications with different shaft materials, p=108 psi, v=98 fpm

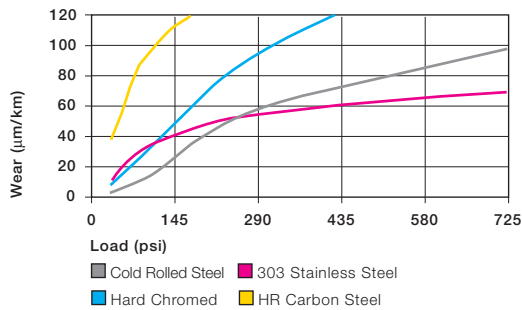

Graph 15.9: Wear of iglide® Z with different shaft materials in rotating applications

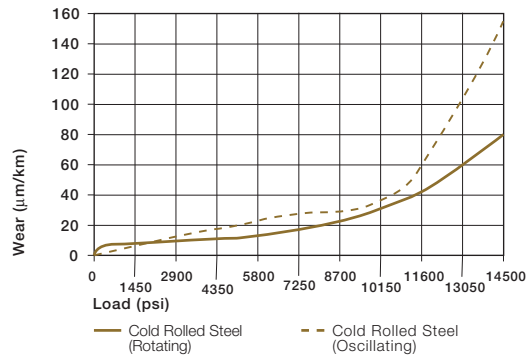

Graph 15.10: Wear for oscillating and rotating applications with Cold Rolled Steel shafts

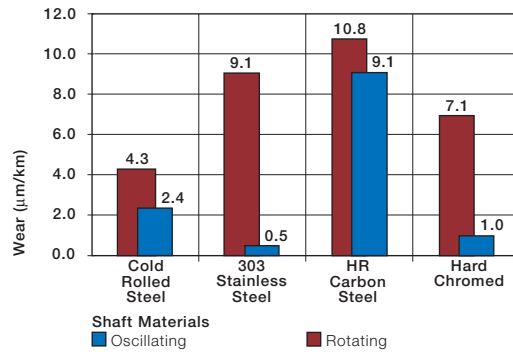

Graph 15.11: Wear for oscillating and rotating applications with different shaft materials, load p = 290 psi



iglide® Z

Telephone 1-800-521-2747
1-401-438-7270
Fax

Internet: <http://www.igus.com>
email: sales@igus.com
QuickSpec: <http://www.igus.com/iglide-quickspec>

Chemical Resistance

iglide® Z plain bearings have a good resistance to chemicals. They have an excellent resistance against organic solvents, fuels, oils and greases. The material is only partially resistant against weak acids. The moisture absorption of iglide® Z plain bearings is approximately 0.3% in standard atmosphere. The saturation limit in water is 1.1%.

► Chemical Resistance, Page 1.16

Medium	Resistance
Alcohol	0
Hydrocarbons, chlorinated	+
Greases, oils without additives	+
Fuels	+
Weak acids	+
Strong acids	-
Weak alkaline	+
Strong alkaline	-

+ resistant, 0 conditionally resistant, - not resistant

Table 15.5: Chemical resistance of iglide® Z
All data given concerns the chemical resistance at room temperature (68°F). For a complete list, see page 1.16

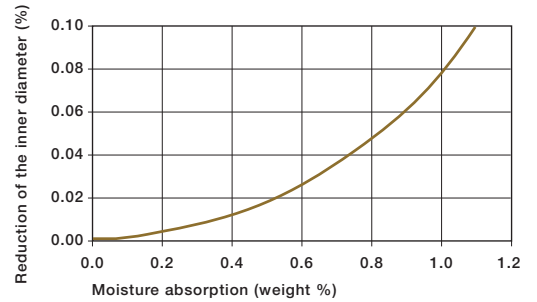

Graph 15.12: Effect of moisture absorption on iglide® Z plain bearings

Radiation Resistance

Plain bearings made from iglide® Z are resistant to radiation up to an intensity of 1×10^5 Gy.

UV-Resistance

UV radiation causes approximately 50% decline of the tribological properties (wear) of plain bearings made from iglide® Z.

Vacuum

For use in a vacuum environment, moisture content is released as vapor. Therefore, only dehumidified bearings made of iglide® Z are suitable for a vacuum environment.

Electrical Properties

iglide® Z plain bearings are electrically insulating.

iglide® Z

Specific volume resistant	> $10^{11} \Omega\text{cm}$
Surface resistance	> $10^{11} \Omega$

Table 15.6: Electrical properties of iglide® Z

iglide® Plain Bearings

Z - Sleeve, Inch

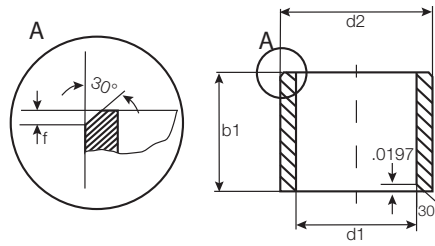

For tolerance values please refer to page 15.4

Part Number	d1	d2	b1	I.D. After Pressfit		Housing Bore		Shaft Size	
				Max.	Min.	Max.	Min.	Max.	Min.
ZSI-0203-03	1/8	3/16	3/16	.1266	.1247	.1878	.1873	.1243	.1236
ZSI-0506-06	5/16	3/8	3/8	.3143	.3120	.3753	.3747	.3115	.3106
ZSI-0607-04	3/8	15/32	1/4	.3768	.3745	.4691	.4685	.3740	.3731
ZSI-0607-06	3/8	15/32	3/8	.3768	.3745	.4691	.4685	.3740	.3731
ZSI-0607-08	3/8	15/32	1/2	.3768	.3745	.4691	.4685	.3740	.3731
ZSI-0708-08	7/16	17/32	1/2	.4399	.4371	.5316	.5307	.4365	.4355
ZSI-0809-12	1/2	19/32	3/4	.5024	.4996	.5941	.5933	.4990	.4980
ZSI-0810-12	1/2	5/8	3/4	.5034	.5006	.6260	.6248	.5000	.4990
ZSI-1011-12	5/8	23/32	3/4	.6274	.6246	.7192	.7185	.6240	.6230
ZSI-1214-12	3/4	7/8	3/4	.7532	.7499	.8755	.8748	.7491	.7479
ZSI-1214-16	3/4	7/8	1	.7532	.7499	.8755	.8748	.7491	.7479
ZSI-1416-16	7/8	1	1	.8782	.8749	1.0005	.9997	.8741	.8729
ZSI-1618-16	1	1 1/8	1	1.0032	.9999	1.1255	1.1247	.9991	.9979
ZSI-1618-24	1	1 1/8	1 1/2	1.0032	.9999	1.1255	1.1247	.9991	.9979
ZSI-1820-24	1 1/8	1 9/32	1 1/2	1.1279	1.1246	1.2818	1.2807	1.1238	1.1226
ZSI-2022-20	1 1/4	1 13/32	1 1/4	1.2537	1.2498	1.4068	1.4059	1.2488	1.2472
ZSI-2426-24	1 1/2	1 21/32	1 1/2	1.5037	1.4998	1.6568	1.6559	1.4988	1.4972
ZSI-2831-32	1 3/4	1 15/16	2	1.7536	1.7497	1.9381	1.9370	1.7487	1.7471
ZSI-3235-16	2	2 3/16	1	2.0040	1.9993	2.1883	2.1870	1.9981	1.9969
ZSI-3235-32	2	2 3/16	2	2.0040	1.9993	2.1883	2.1870	1.9981	1.9969
ZSI-3639-32	2 1/4	2 7/16	2	2.2566	2.2519	2.4377	2.4366	2.2507	2.2489

iglide® Z
Sleeve - Inch

PDF: www.igus.com/iglide-pdfs
CAD: www.igus.com/iglide-CAD
RoHS info: www.igus.com/RoHS





iglide® Plain Bearings Z - Flange, Inch

iglide® Z
Flange - Inch

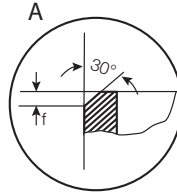

r = max. .0197

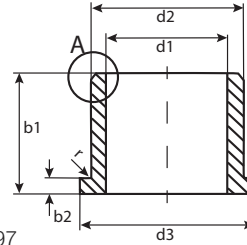

For tolerance values please refer to page 15.4

Telephone 1-800-521-2747
Fax 1-401-438-7270

Part Number	d1	d2	b1	d3	b2 -.0055	I.D. After Pressfit		Housing Bore		Shaft Size	
						Max.	Min.	Max.	Min.	Max.	Min.
ZFI-0405-08	1/4	5/16	1/2	.500	.032	.2518	.2495	.3128	.3122	.2490	.2476
ZFI-0506-06	5/16	3/8	3/8	.562	.032	.3143	.3120	.3753	.3747	.3115	.3101
ZFI-0607-08	3/8	15/32	1/2	.687	.046	.3768	.3745	.4691	.4684	.3740	.3731
ZFI-0708-08	7/16	17/32	1/2	.750	.046	.4399	.4371	.5314	.5307	.4365	.4348
ZFI-1012-08	5/8	3/4	1/2	1.000	.062	.6284	.6256	.7508	.7500	.6250	.6240
ZFI-1214-12	3/4	7/8	3/4	1.125	.062	.7532	.7499	.8755	.8748	.7491	.7479
ZFI-1214-16	3/4	7/8	1	1.125	.062	.7532	.7499	.8755	.8748	.7491	.7479
ZFI-1416-12	7/8	1	3/4	1.250	.062	.8782	.8749	1.0005	.9997	.8741	.8729
ZFI-1416-16	7/8	1	1	1.250	.062	.8782	.8749	1.0005	.9997	.8741	.8729
ZFI-1618-08	1	1 1/8	1/2	1.375	.062	1.0032	.9999	1.1255	1.1247	.9991	.9979
ZFI-1618-16	1	1 1/8	1	1.375	.062	1.0032	.9999	1.1255	1.1247	.9991	.9979
ZFI-1820-12	1 1/8	1 9/32	3/4	1.562	.078	1.1279	1.1246	1.2818	1.2807	1.1238	1.1226
ZFI-1820-24	1 1/8	1 9/32	1 1/2	1.562	.078	1.1279	1.1246	1.2818	1.2807	1.1238	1.1226
ZFI-2022-20	1 1/4	1 13/32	1 1/4	1.687	.078	1.2537	1.2498	1.4068	1.4059	1.2488	1.2472
ZFI-2022-24	1 1/4	1 13/32	1 1/2	1.687	.078	1.2537	1.2498	1.4068	1.4059	1.2488	1.2472
ZFI-2426-24	1 1/2	1 21/32	1 1/2	2.000	.078	1.5037	1.4998	1.6568	1.6559	1.4988	1.4972
ZFI-2831-32	1 3/4	1 15/16	2	2.375	.093	1.7536	1.7497	1.9381	1.9370	1.7487	1.7471
ZFI-3235-32	2	2 3/16	2	2.625	.093	2.0040	1.9993	2.1883	2.1870	1.9981	1.9969

Internet: <http://www.igus.com>
email: sales@igus.com
QuickSpec: <http://www.igus.com/iglide-quickspec>

iglide® Plain Bearings Z - Sleeve, MM



iglide® Z
Sleeve - MM

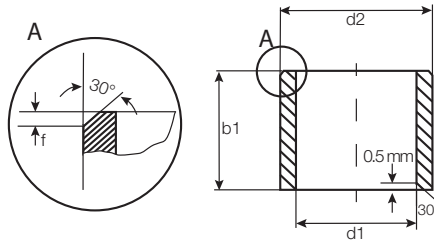

For tolerance values please refer to page 15.4

Dimensions according to ISO 3547-1 and special dimensions

Part Number	d1	d1-Tolerance		d2	b1	I.D. After Pressfit		Housing Bore		Shaft Size	
		After Pressfit in Ø H7				Max.	Min.	Max.	Min.	Max.	Min.
ZSM-0405-04	4.0	+0.010	+0.058	5.5	4.0	4.058	4.010	5.512	5.500	4.000	3.970
ZSM-0507-05	5.0	+0.010	+0.058	7.0	5.0	5.058	5.010	7.015	7.000	5.000	4.970
ZSM-0608-08	6.0	+0.010	+0.058	8.0	8.0	6.058	6.010	8.015	8.000	6.000	5.970
ZSM-0608-12	6.0	+0.010	+0.058	8.0	12.0	6.058	6.010	8.015	8.000	6.000	5.970
ZSM-0810-08	8.0	+0.013	+0.071	10.0	8.0	8.071	8.013	10.015	10.000	8.000	7.964
ZSM-0810-10	8.0	+0.013	+0.071	10.0	10.0	8.071	8.013	10.015	10.000	8.000	7.964
ZSM-1012-08	10.0	+0.013	+0.071	12.0	8.0	10.071	10.013	12.018	12.000	10.000	9.964
ZSM-1012-10	10.0	+0.013	+0.071	12.0	10.0	10.071	10.013	12.018	12.000	10.000	9.964
ZSM-1012-12	10.0	+0.013	+0.071	12.0	12.0	10.071	10.013	12.018	12.000	10.000	9.964
ZSM-1214-15	12.0	+0.016	+0.086	14.0	15.0	12.086	12.016	14.018	14.000	12.000	11.957
ZSM-1517-15	15.0	+0.016	+0.086	17.0	15.0	15.086	15.016	17.018	17.000	15.000	13.957
ZSM-1618-12	16.0	+0.016	+0.086	18.0	12.0	16.086	16.016	18.018	18.000	16.000	15.957
ZSM-1618-15	16.0	+0.016	+0.086	18.0	15.0	16.086	16.016	18.018	18.000	16.000	15.957
ZSM-1820-20	18.0	+0.016	+0.086	20.0	20.0	18.086	18.016	20.021	20.000	18.000	19.948
ZSM-2022-15	20.0	+0.020	+0.104	22.0	15.0	20.104	20.020	22.021	22.000	20.000	19.948
ZSM-2023-20	20.0	+0.020	+0.104	23.0	20.0	20.104	20.020	23.021	23.000	20.000	19.948
ZSM-2023-30	20.0	+0.020	+0.104	23.0	30.0	20.104	20.020	23.021	23.000	20.000	19.948
ZSM-2023-35	20.0	+0.020	+0.104	23.0	35.0	20.104	20.020	23.021	23.000	20.000	19.948
ZSM-2225-20	22.0	+0.020	+0.104	25.0	20.0	22.104	22.020	25.021	25.000	22.000	21.948
ZSM-2528-20	25.0	+0.020	+0.104	28.0	20.0	25.104	25.020	28.021	28.000	25.000	24.948
ZSM-2528-30	25.0	+0.020	+0.104	28.0	30.0	25.104	25.020	28.021	28.000	25.000	24.948
ZSM-2528-48	25.0	+0.020	+0.104	28.0	48.0	25.104	25.020	28.021	28.000	25.000	24.948
ZSM-3034-20	30.0	+0.020	+0.104	34.0	20.0	30.104	30.020	34.025	34.000	30.000	29.948
ZSM-3034-30	30.0	+0.020	+0.104	34.0	30.0	30.104	30.020	34.025	34.000	30.000	29.948
ZSM-3034-40	30.0	+0.020	+0.104	34.0	40.0	30.104	30.020	34.025	34.000	30.000	29.948
ZSM-3539-20	35.0	+0.025	+0.125	39.0	20.0	35.125	35.025	39.025	39.000	35.000	34.938
ZSM-4044-40	40.0	+0.025	+0.125	44.0	40.0	40.125	40.025	44.025	44.000	40.000	39.938
ZSM-5055-60	50.0	+0.025	+0.125	55.0	60.0	50.125	50.025	55.030	55.000	50.000	49.938
ZSM-6065-60	60.0	+0.025	+0.125	65.0	60.0	60.125	60.025	65.030	65.000	60.000	59.926

PDF: www.igus.com/iglide-pdfs
CAD: www.igus.com/iglide-CAD
RoHS info: www.igus.com/RoHS





iglide® Plain Bearings Z - Flange, MM

iglide® Z
Flange - MM

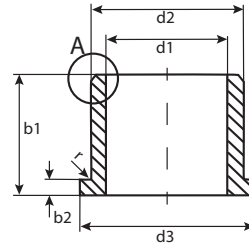
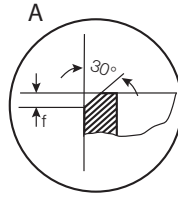

For tolerance values please refer to page 15.4

r = max. 0.5

Dimensions according to ISO 3547-1 and special dimensions

Part Number	d1 ¹⁾		d2	d3	b1	b2	I.D. After Pressfit		Housing Bore		Shaft Size	
	After Pressfit in Ø H7						Max.	Min.	Max.	Min.	Max.	Min.
ZFM-0405-04	4.0	+0.010 +0.058	5.5	9.5	4.0	0.75	4.058	4.010	5.512	5.500	4.000	3.970
ZFM-0507-05	5.0	+0.010 +0.058	7.0	11.0	5.0	1.00	5.058	5.010	7.015	7.000	5.000	4.970
ZFM-0608-08	6.0	+0.010 +0.058	8.0	12.0	8.0	1.0	6.058	6.010	8.015	8.000	6.000	5.970
ZFM-0810-09	8.0	+0.013 +0.071	10.0	15.0	9.0	1.0	8.071	8.013	10.015	10.000	8.000	7.964
ZFM-1012-09	10.0	+0.013 +0.071	12.0	18.0	9.0	1.0	10.071	10.013	12.018	12.000	10.000	9.964
ZFM-1214-09	12.0	+0.016 +0.086	14.0	20.0	9.0	1.0	12.086	12.016	14.018	14.000	12.000	11.957
ZFM-1214-12	12.0	+0.016 +0.086	14.0	20.0	12.0	1.0	12.086	12.016	14.018	14.000	12.000	11.957
ZFM-1214-15	12.0	+0.016 +0.086	14.0	20.0	15.0	1.0	12.086	12.016	14.018	14.000	12.000	11.957
ZFM-1214-20	12.0	+0.016 +0.086	14.0	20.0	20.0	1.0	12.086	12.016	14.018	14.000	12.000	11.957
ZFM-1416-16	14.0	+0.016 +0.086	16.0	22.0	16.0	1.0	14.086	14.016	16.018	16.000	14.000	13.957
ZFM-1416-17	14.0	+0.016 +0.086	16.0	22.0	17.0	1.0	14.086	14.016	16.018	16.000	14.000	13.957
ZFM-1517-11	15.0	+0.016 +0.086	17.0	23.0	11.0	1.0	15.086	15.016	17.018	17.000	15.000	14.957
ZFM-1517-15	15.0	+0.016 +0.086	17.0	23.0	15.0	1.0	15.086	15.016	17.018	17.000	15.000	14.957
ZFM-1820-04	18.0	+0.013 +0.071	20.0	26.0	4.0	1.0	18.071	18.013	20.021	20.000	18.000	17.957
ZFM-1820-17	18.0	+0.013 +0.071	20.0	26.0	17.0	1.0	18.071	18.013	20.021	20.000	18.000	17.957
ZFM-2022-21	20.0	+0.020 +0.104	22.0	30.0	21.0	1.5	20.104	20.020	22.040	22.000	20.000	19.948
ZFM-2023-11	20.0	+0.020 +0.104	23.0	30.0	11.5	1.5	20.104	20.020	23.021	23.000	20.000	19.948
ZFM-2023-155	20.0	+0.020 +0.104	23.0	30.0	15.5	1.5	20.104	20.020	23.021	23.000	20.000	19.948
ZFM-2023-16	20.0	+0.020 +0.104	23.0	30.0	16.0	1.5	20.104	20.020	23.021	23.000	20.000	19.948
ZFM-2023-21	20.0	+0.020 +0.104	23.0	30.0	21.5	1.5	20.104	20.020	23.021	23.000	20.000	19.948
ZFM-2023-31	20.0	+0.020 +0.104	23.0	30.0	31.5	1.5	20.104	20.020	23.021	23.000	20.000	19.948
ZFM-2528-16	25.0	+0.020 +0.104	28.0	35.0	16.5	1.5	25.104	25.020	28.021	28.000	25.000	24.948
ZFM-2528-21	25.0	+0.020 +0.104	28.0	35.0	21.5	1.5	25.104	25.020	28.021	28.000	25.000	24.948
ZFM-2528-31	25.0	+0.020 +0.104	28.0	35.0	31.5	1.5	25.104	25.020	28.021	28.000	25.000	24.948
ZFM-3034-20	30.0	+0.020 +0.104	34.0	42.0	20.0	2	30.104	30.020	34.025	34.000	30.000	29.948
ZFM-3034-26	30.0	+0.020 +0.104	34.0	42.0	26.0	2.0	30.104	30.020	34.025	34.000	30.000	29.948
ZFM-3034-37	30.0	+0.020 +0.104	34.0	42.0	37.0	2.0	30.104	30.020	34.025	34.000	30.000	29.948
ZFM-3539-26	35.0	+0.025 +0.125	39.0	47.0	26.0	2.0	35.125	35.025	39.025	39.000	35.000	34.938
ZFM-4044-20	40.0	+0.025 +0.125	44.0	52.0	20.0	2.0	40.125	40.025	44.025	44.000	40.000	39.938
ZFM-4044-40	40.0	+0.025 +0.125	44.0	52.0	40.0	2.0	40.125	40.025	44.025	44.000	40.000	39.938
ZFM-7580-50	75.0	+0.030 +0.150	80.0	88.0	50.0	2.0	75.150	75.030	80.030	80.000	75.000	74.926

Telephone 1-800-521-2747
Fax 1-401-438-7270

Internet: <http://www.igus.com>
email: sales@igus.com
QuickSpec: <http://www.igus.com/iglide-quickspec>

iglide® Plain Bearings
Z - Thrust Washer, MM

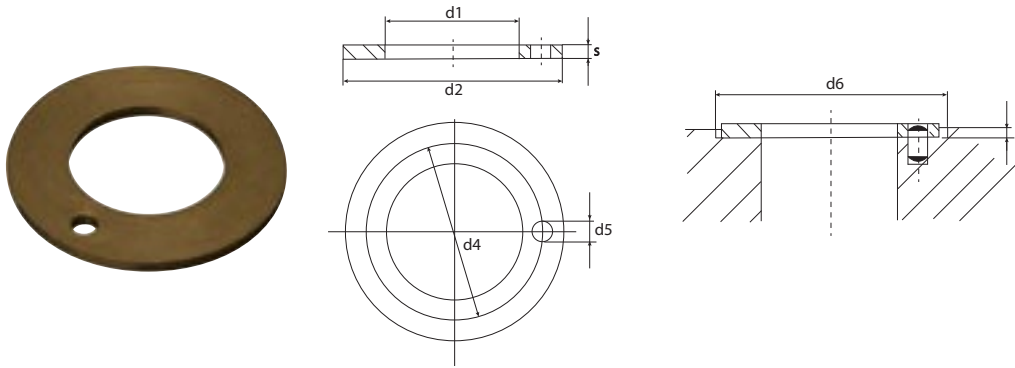

Dimensions according to ISO 3547-1 and special dimensions

Part number	d1 +0.25	d2 -0.25	s -0.05	d4 -0.12 +0.12	d5 +0.375 +0.125	h +0.2 -0.2	d6 +0.12
ZTM-2644-015	26.0	44.0	1.5	35.0	3.0	1.0	44.0
ZTM-3254-015	32.0	54.0	1.5	43.0	4.0	1.0	54.0
ZTM-4874-020	48.0	74.0	2.0	61.0	4.0	1.5	74.0
ZTM-6290-020	62.0	90.0	2.0	76.0	4.0	1.5	90.0

iglide® Z
Thrust Washer - MM

PDF: www.igus.com/iglide-pdfs
CAD: www.igus.com/iglide-CAD
RoHS info: www.igus.com/RoHS



iglide® Plain Bearings
Z - Notes

iglide® Z

Telephone 1-800-521-2747
Fax 1-401-438-7270

Internet: <http://www.igus.com>
email: sales@igus.com
QuickSpec: <http://www.igus.com/iglide-quickspec>

igus[®]



xiros[®]



Ball Bearings
iglide® B180
PA cage
Stainless steel balls

Page 16.8



Ball Bearings
iglide® B180
PA cage
Glass balls

Page 16.9



Ball Bearings
iglide® A500
PA cage
Stainless steel balls

Page 16.10



Ball Bearings
iglide® A500
PEEK cage
Stainless steel balls

Page 16.11



Ball Bearings
iglide® A500
PEEK cage
Glass balls

Page 16.12



Ball Bearings
iglide® A500
PEEK cage
PAI balls

Page 16.13



Ball Bearings
iglide® C160
PP cage
Stainless steel balls

Page 16.14



Ball Bearings
iglide® C160
PP cage
Glass balls

Page 16.15



Ball Bearings
iglide® B180
PA cage
Stainless steel balls
with cover plate

Page 16.16



Ball Bearings
iglide® B180
PA cage
Glass balls
with cover plate

Page 16.17



Slewing Ring Bearings
iglide® B180
Stainless steel balls

Page 16.18



Slewing Ring Bearings
iglide® B180
Glass balls

Page 16.18



Ball Transfer Unit
iglide® B180
POM balls

Page 16.19



ESTM Pillow Block
iglide® B180
Stainless steel or
Glass balls
Fixed

Page 16.20



ESTM Pillow Block
iglide® B180
Stainless steel or
Glass balls
Pivoting

Page 16.21



EFSM 4-Bolt Flange
iglide® B180
Stainless steel or
Glass balls

Page 16.22



EFOM 2-Bolt Flange
iglide® B180
Stainless steel or
Glass balls

Page 16.23



Thermoforming Machine

In this thermoforming machine for coffee-cream portion packs, xiros® plastic ball bearings are used for their high chemical resistance.

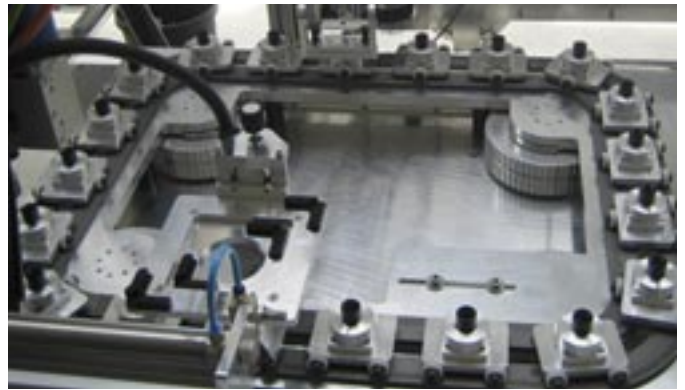

Indexing Table

This indexing table is used to test metal balls for cracks and dimensional accuracy. xiros® plastic ball bearings are used here as wheels for the trolley.



Wet Film Thickness Gage

This precision tester for accurate and rapid measurement of all liquid paint, coatings, oil coatings and adhesives is equipped with a durable and solvent resistant xiros® B180 ball bearing.



Film Guide Rollers

There is no contamination of the films through lubricants, due to the use of maintenance-free xiros® flange bearings.



Model Plane

The use of remote controlled model aircraft is being tested and demonstrated as a remote sensing platform at the Institute of Space Systems (IRS). Due to the extreme low weight requirements, the xiros® flange bearings are used here.



Small Robot

The wheels of this little low cost robot are two xiros® B180 plastic ball bearings. These ensure a totally maintenance-free, lubricant-free and easily functioning application.



Product Range

- Available in 3 materials
- 10 product types are available
- Inner diameters:
Metric sizes from 3 - 60 mm

Part Number Structure

Part Number Structure

B 6004 A 1 G

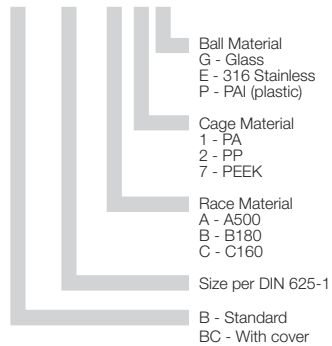

Temperatures

	Minimum	Maximum
A500	-148°F (PEEK)	+302°F
	-40°F (PAI)	+302°F
B180	-40°F	+176°F
C160	-40°F	+176°F

Usage Guidelines



- For rotational speeds that exceed the limits of a plain bearing
- When corrosion resistance is required
- For temperatures up to 302°F (depending on material)
- When chemical resistance is required
- If non-magnetic ball bearings are needed
- When FDA compliance is needed (A500 with PEEK cage)



- For high loads at high speeds
- When very tight clearances are required

iglide® xiros® ball bearing open up fields of application for plastic bearings. The inner and outer races of the iglide® xiros® are made from high performance iglide® materials. The corrosion-free balls are made from stainless steel. Glass balls are also available for maximum corrosion resistance. xiros® made from the A500 material is temperature-resistant up to 302°F, while the xiros® from the B180 material is designed for temperatures up to 176°F.



Material Table

General Properties	Unit	iglide® A500	iglide® B180	iglide® C160
Density	g/cm³	1.28	1.41	1.11
Color		Brown	Cream	opaque
Max. moisture absorption at 73°F/50% r.h.	% weight	0.3	0.3	0.1
Max. moisture absorption	% weight	0.5	1.3	0.2

Mechanical Properties

Modulus of elasticity	psi	522,100	348,090	275,571
Tensile strength at 68°F	psi	20,300	10,587	5,076
Shore D-hardness		83	74	67

Electrical Properties

Specific volume resistance	Ωcm	> 10 ¹⁴	10 ¹³	10 ¹⁴
Surface resistance	Ω	> 10 ¹³	10 ¹²	10 ¹⁴

Recommendation of tolerance for bore and shaft at xiros® radial ball bearings

We recommend a H7-tolerance of the housing bore of xiros® radial ball bearings and a h6-tolerance of the shaft. For further questions about the dimensioning of the bore and the shaft please contact us.



xiros® polymer ball bearings are comprised of a variety of different product materials. No xiros® part requires any additional lubrication. Other advantages are (depending on the design):

- Maintenance-free
- Light weight
- Free from metal (when using glass and plastic balls)
- Non-magnetic
- Chemical resistant
- Corrosion resistant
- Electrically insulating
- FDA-compliant
- Predictable lifetime

The predictability of xiros® polymer ball bearing is one of the most important advantages. Based on the results of many wear tests, the user can calculate the lifetime of the xiros® polymer ball bearings using the xiros® expert system.

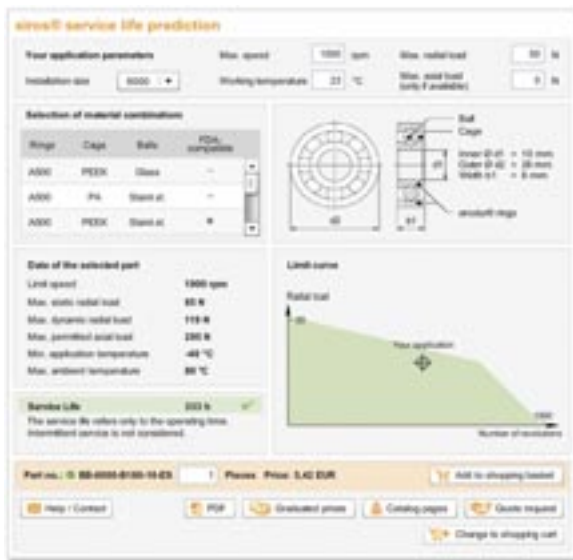

Design

The xiros® polymer ball bearings are single-row grooved ball bearings based on DIN 625. The lubricant-free and maintenance-free ball bearings consist of four components:

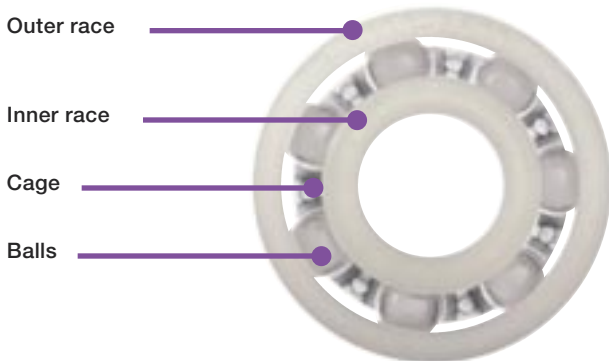

The Outer- and Inner Race

The suitability of a xiros® polymer ball bearings is largely determined by the materials of the two races. These are made from iglus® tribopolymers to maximize service life and minimize friction. You can choose from three different materials and they allow different values of application temperature, chemical resistance and loading. Please refer to the Material Data Table on the previous page for details about general, mechanical and electrical properties.

The Cage

The cage materials in xiros® ball bearings should also be taken into consideration. The different materials differ greatly in terms of chemical resistance and temperature abilities.

The Balls

The ball materials differ significantly. In addition to 316 stainless steel balls, we also offer glass and plastic versions. The difference in ball materials has an effect on mass, which in turn affects smoothness, weight and chemical resistance.

Stainless steel balls are both cost-effective and chemical resistant, but also have the highest weight of the three options.

Glass balls offer a metal-free solution. They offer high chemical resistant and lower weight.

Plastic balls are the lowest weight of the three options. Plastic balls are quiet and also, depending on which race material is used, offer excellent chemical resistance.

Pillow Block and Flange Bearings

This range is made up by combining xiros® polymer ball bearing with the igubal® pillow block and flange bearings, resulting in a higher flexibility in terms of installation of the bearings. The pre-finished bearing housing makes it easy for the user to use these maintenance-free components. Both flanged and pillow block designs are available as fixed or pivoting.

The difference between the two options is that the pivoting type can compensate for shaft and/or bearing misalignment. A spherical outer race is pressed into the bearing housing, ensuring self aligning action.

iglide® xiros®

PDF: www.igus.com/iglide-pdfs
 CAD: www.igus.com/iglide-CAD
 RoHS info: www.igus.com/RoHS





iglide® xiros

Telephone 1-800-521-2747
1-401-438-7270
Fax

Internet: <http://www.igus.com>
email: sales@igus.com
QuickSpec: <http://www.igus.com/iglide-quickspec>

Application Areas

In contrast to metallic ball bearings, xiros® plastic ball bearings run without any lubrication. Applications requiring cleanroom, chemical resistance or need to be contaminant-free in industries such as medical, food, packaging, electronics and many more are a perfect area for the xiros® ball bearings.

Development and Tests

Through numerous tests the race materials were optimized. The plastics igus® developed for use with xiros® ball bearings allow higher speeds, greater loads, and longer service life. Plastic ball bearing technology will continue to advance, especially with igus®' experience and development of tribological plastic materials.

In the igus® test laboratory the life and wear of xiros® plastic ball bearings was and continues to be tested. In addition to the actual material comparison, tests indicate these experiments also answer questions about the impact of external influences such as temperature, humidity or dust.

The material combinations for bearing races, balls and cages are tested in the igus® test laboratory for a variety of loads and speeds. Thus, the application-specific selection of the suitable bearing and a Lifetime calculation is possible.

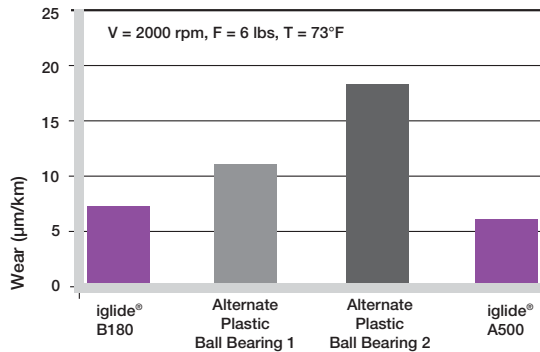

Wear test in igus® laboratory

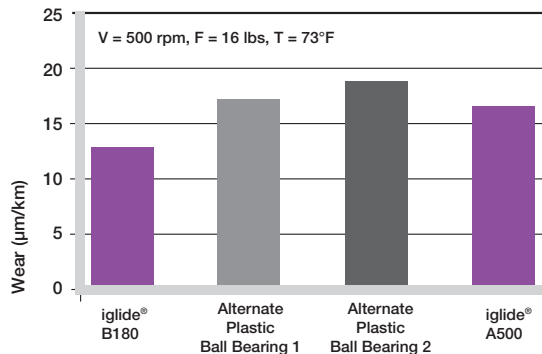

Wear test in igus® laboratory

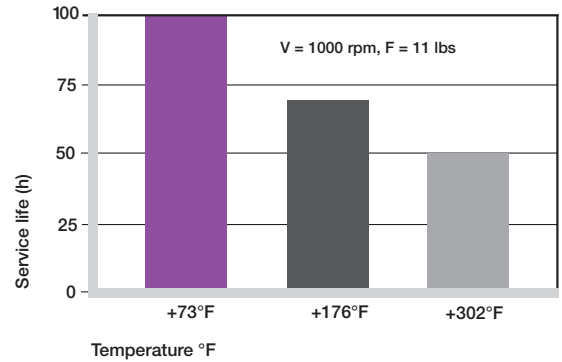

Service life of iglide® A500 plastic ball bearings at different ambient temperatures, dry

Predictability

As part of the development of xiros® polymer ball bearing tests are carried out continuously. The extreme number of test results make it very difficult to present this information in one table.

It is for this reason that igus has developed the online life calculator, which uses real test results to give an accurate calculation.



Test benches for xiros® plastic ball bearings at igus® laboratory



The lifetime-calculator is online at
www.igus.eu/xiros-expert

Immediately after entering the data, the lifetime is calculated and displayed. It is important to remember that the result given is based on actual test results in the igus laboratory, and is therefore completely reliable.

iglide® xiros®

xiros® service life prediction

Your application parameters

Installation size:

Max. speed: rpm

Working temperature: °C

Max. radial load: N

Max. axial load (only if available): N

Selection of material combinations

Rings	Cage	Balls	FDA-compatible
A500	PEEK	Glass	-
A500	PA	Stainl.st.	-
A500	PEEK	Stainl.st.	●

Data of the selected part

Limit speed	1900 rpm
Max. static radial load	85 N
Max. dynamic radial load	119 N
Max. permitted axial load	285 N
Min. application temperature	-40 °C
Max. ambient temperature	80 °C

Limit curve

Service Life **333 h** ✓

The service life refers only to the operating time. Intermittent service is not considered.

Part no.: Pieces Price: 5,42 EUR

[Add to shopping basket](#)

[Help / Contact](#)

[PDF](#)

[Graduated prices](#)

[Catalog pages](#)

[Quote request](#)

[Change to shopping cart](#)

PDF: www.igus.com/iglide-pdfs
 CAD: www.igus.com/iglide-CAD
 RoHS info: www.igus.com/RoHS





xiros® Ball Bearings B180 Material, PA Cage Stainless Steel Balls, mm

xiros® B180 plastic ball bearings are for use with temperatures up to 176°F. The specially developed material iglide® B180 provides significantly longer lifetimes at a lower cost.

iglide® xiros



iglide® B180 PA cage, stainless steel balls

Temperature range
-40°F to +176°F

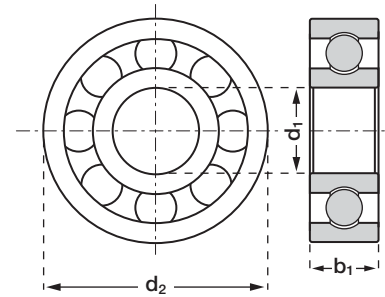

Dimensions (mm)

Part number	Race Material	Cage Material	Ball Material	Inner-Ø d1 (mm)	Outer-Ø d2 (mm)	Width b1 (mm)
B623B1E	B180	PA	316 SS	3	10	4
B625B1E	B180	PA	316 SS	5	15	5
B626B1E	B180	PA	316 SS	6	19	6
B608B1E	B180	PA	316 SS	8	22	7
B6000B1E	B180	PA	316 SS	10	26	8
B6001B1E	B180	PA	316 SS	12	28	8
B6003B1E	B180	PA	316 SS	17	35	10
B6004B1E	B180	PA	316 SS	20	42	12
B6005B1E	B180	PA	316 SS	25	47	12
B6006B1E	B180	PA	316 SS	30	55	13
B6007B1E	B180	PA	316 SS	35	62	14
B6008B1E	B180	PA	316 SS	40	68	15
B6009B1E	B180	PA	316 SS	45	75	16
B6010B1E	B180	PA	316 SS	50	80	16
B6011B1E	B180	PA	316 SS	55	90	18
B6012B1E	B180	PA	316 SS	60	95	18

Technical Data

Part number	Max. Static load axial (lbs)	Static load rating (lbs)	Dynamic load rating (lbs)	Maximum speed (rpm)	Weight (g)
B623B1E	7	6	8	4,500	0.4
B625B1E	17	9	13	3,100	1.0
B626B1E	21	11	16	2,600	2.2
B608B1E	37	13	19	2,200	3.9
B6000B1E	64	19	27	1,900	6.1
B6001B1E	71	24	33	1,750	6.9
B6003B1E	81	40	56	1,400	11.1
B6004B1E	90	47	66	1,150	20.2
B6005B1E	117	54	81	1,050	23.9
B6006B1E	144	63	94	900	35.0
B6007B1E	162	72	108	800	47.0
B6008B1E	180	78	117	750	56.3
B6009B1E	202	85	126	650	71.5
B6010B1E	214	88	130	600	83.1
B6011B1E	225	90	135	550	125.2
B6012B1E	247	94	144	500	129.6

Telephone 1-800-521-2747
Fax 1-401-438-7270

Internet: <http://www.igus.com>
email: sales@igus.com
QuickSpec: <http://www.igus.com/iglide-quickspec>

xiros® Ball Bearings B180 Material, PA Cage Glass Balls, mm



xiros® B180 plastic ball bearings are for use with temperatures up to 176°F. The specially developed material iglide® B180 provides significantly longer lifetimes at a lower cost.



iglide® B180 PA cage,
glass balls

Temperature range
-40°F to +176°F

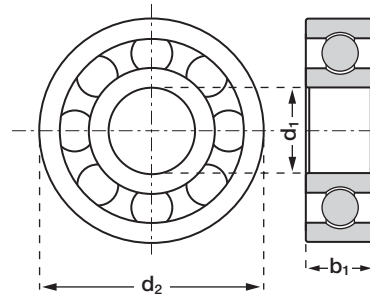

Dimensions (mm)

Part number	Race Material	Cage Material	Ball Material	Inner-Ø d1 (mm)	Outer-Ø d2 (mm)	Width b1 (mm)
B623B1G	B180	PA	Glass	3	10	4
B625B1G	B180	PA	Glass	5	15	5
B626B1G	B180	PA	Glass	6	19	6
B608B1G	B180	PA	Glass	8	22	7
B6000B1G	B180	PA	Glass	10	26	8
B6001B1G	B180	PA	Glass	12	28	8
B6003B1G	B180	PA	Glass	17	35	10
B6004B1G	B180	PA	Glass	20	42	12
B6005B1G	B180	PA	Glass	25	47	12
B6006B1G	B180	PA	Glass	30	55	13
B6007B1G	B180	PA	Glass	35	62	14
B6008B1G	B180	PA	Glass	40	68	15
B6009B1G	B180	PA	Glass	45	75	16
B6010B1G	B180	PA	Glass	50	80	16
B6011B1G	B180	PA	Glass	55	90	18
B6012B1G	B180	PA	Glass	60	95	18

Technical Data

Part number	Max. static load axial (lbs)	Static load rating (lbs)	Dynamic load rating (lbs)	Maximum speed (rpm)	Weight (g)
B623B1G	7	6	8	4,500	0.3
B625B1G	17	9	13	3,100	1.0
B626B1G	21	11	16	2,600	1.7
B608B1G	37	13	19	2,200	2.6
B6000B1G	64	19	27	1,900	4.0
B6001B1G	71	24	33	1,750	4.5
B6003B1G	81	40	56	1,400	7.9
B6004B1G	90	47	66	1,150	13.6
B6005B1G	117	54	81	1,050	16.7
B6006B1G	144	63	94	900	24.2
B6007B1G	162	72	108	800	31.3
B6008B1G	180	78	117	750	39.1
B6009B1G	202	85	126	650	48.6
B6010B1G	214	88	130	600	56.4
B6011B1G	225	90	135	550	84.4
B6012B1G	247	94	144	500	85.6

iglide® xiros®

PDF: www.igus.com/iglide-pdfs
CAD: www.igus.com/iglide-CAD
RoHS info: www.igus.com/RoHS

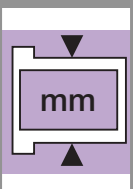
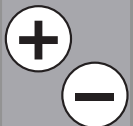



xiros® Ball Bearings A500 Material, PA Cage Stainless Steel Balls, mm

xiros® polymer ball bearings with the combination of PA cage and stainless steel balls are the economic alternative of the iglide® A500 product range, when temperature is merely up to 302°F and no chemicals are in use.

iglide® xiros



Special properties

- For temperatures up to 302°F
- Maximum chemical resistance

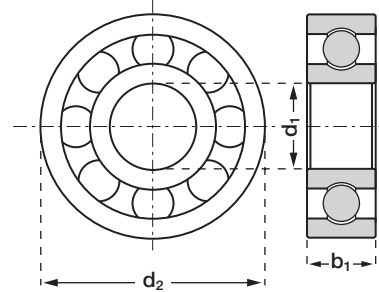

iglide® A500, PA cage,
stainless steel balls

Temperature range
-40°F to +302°F

Dimensions (mm)

Part number	Race Material	Cage Material	Ball Material	Inner-Ø d1 (mm)	Outer-Ø d2 (mm)	Width b1 (mm)
B623A1E	A500	PA	316 SS	3	10	4
B626A1E	A500	PA	316 SS	6	19	6
B608A1E	A500	PA	316 SS	8	22	7
B6000A1E	A500	PA	316 SS	10	26	8
B6004A1E	A500	PA	316 SS	20	42	12

Technical Data

Part number	Max. static load axial (lbs)	Static load rating (lbs)	Dynamic load rating (lbs)	Maximum speed (rpm)	Weight (g)
B623A1E	9	7	9	5,000	0.4
B626A1E	28	13	18	3,200	2.3
B608A1E	50	16	22	2,700	3.7
B6000A1E	85	23	31	2,100	6.0
B6004A1E	146	56	78	1,300	19.4

Telephone 1-800-521-2747
Fax 1-401-438-7270

Internet: <http://www.igus.com>
email: sales@igus.com
QuickSpec: <http://www.igus.com/iglide-quickspec>

xiros® Ball Bearings

A500 Material, PEEK Cage

Stainless Steel Balls , mm



xiros® plastic ball bearings open up new application areas for plastic roller bearings. After the 2007 market launch, the lifetime of the high-temperature option with iglide® A500 inner and outer races could be clearly raised by up to 5 times.



Special properties

- For temperatures up to 302°F
- Maximum chemical resistance

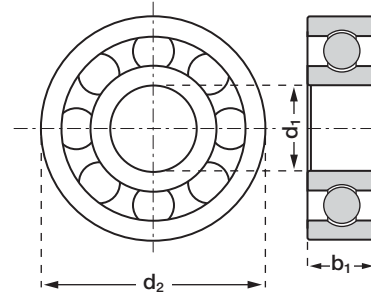

iglide® A500, PEEK cage,
stainless steel balls

Temperature range
-40°F to +302°F



PEEK cages, inner and outer races made
from FDA compliant polymers

Dimensions (mm)

Part number	Race Material	Cage Material	Ball Material	Inner-Ø d1 (mm)	Outer-Ø d2 (mm)	Width b1 (mm)
B623A7E	A500	PEEK	316 SS	3	10	4
B626A7E	A500	PEEK	316 SS	6	19	6
B608A7E	A500	PEEK	316 SS	8	22	7
B6000A7E	A500	PEEK	316 SS	10	26	8
B6004A7E	A500	PEEK	316 SS	20	42	12

Technical Data

Part number	Max. static load axial (lbs)	Static load rating (lbs)	Dynamic load rating (lbs)	Maximum speed (rpm)	Weight (g)
B623A7E	9	7	9	5,000	0.4
B626A7E	28	13	18	3,200	2.3
B608A7E	50	16	22	2,700	3.7
B6000A7E	85	23	31	2,100	6.0
B6004A7E	146	56	78	1,300	19.4

iglide® xiros®

PDF: www.igus.com/iglide-pdfs
CAD: www.igus.com/iglide-CAD
RoHS info: www.igus.com/RoHS





xiros® Ball Bearings A500 Material, PEEK Cage Glass Balls, mm

xiros® plastic ball bearings in combination with a PEEK cage and glass balls are often used in environments where high chemical resistance is necessary and should be free of stainless steel components.

iglide® xiros



Special properties

- For temperatures up to 302°F
- Maximum chemical resistance

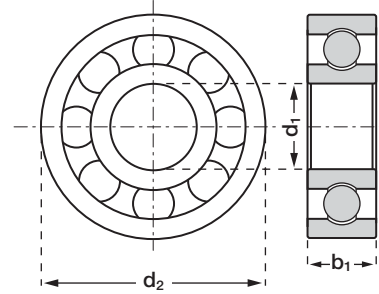

iglide® A500, PEEK cage, glass balls

Temperature range
-148°F to +302°F

Dimensions (mm)

Part number	Race Material	Cage Material	Ball Material	Inner-Ø d1 (mm)	Outer-Ø d2 (mm)	Width b1 (mm)
B623A7G	A500	PEEK	Glass	3	10	4
B626A7G	A500	PEEK	Glass	6	19	6
B608A7G	A500	PEEK	Glass	8	22	7
B6000A7G	A500	PEEK	Glass	10	26	8
B6004A7G	A500	PEEK	Glass	20	42	12

Technical Data

Part number	Max. static load axial (lbs)	Static load rating (lbs)	Dynamic load rating (lbs)	Maximum speed (rpm)	Weight (g)
B623A7G	9	7	9	5,000	0.3
B626A7G	28	13	18	3,200	1.6
B608A7G	50	16	22	2,700	2.4
B6000A7G	85	23	31	2,100	3.8
B6004A7G	146	56	78	1,300	13.2

Telephone 1-800-521-2747
Fax 1-401-438-7270

Internet: <http://www.igus.com>
email: sales@igus.com
QuickSpec: <http://www.igus.com/iglide-quickspec>

xiros® Ball Bearings

A500 Material, PEEK Cage

PAI Balls, mm



iglide® plastic ball bearings are also available with plastic balls. At low loads the wear resistance can be improved by a factor of 3.



Special properties

- Improved wear resistance
- Lightest weight
- For temperatures up to 302°F
- Maximum chemical resistance

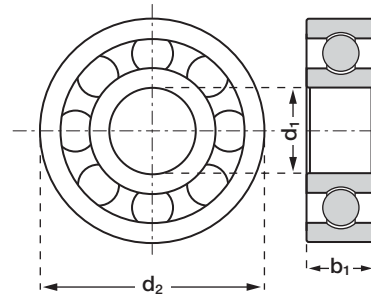

iglide® A500, PEEK cage, PAI Balls

Temperature range
-148°F to +302°F

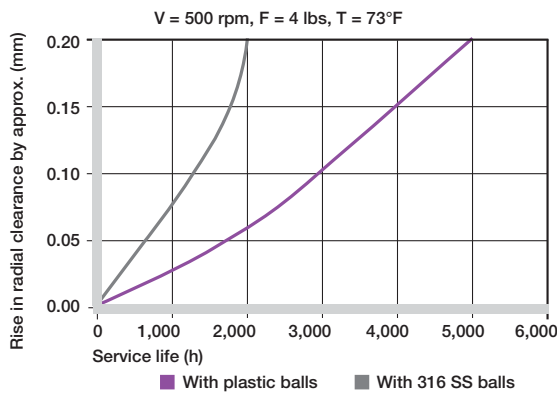

Dimensions (mm)

Part number	Race Material	Cage Material	Ball Material	Inner-Ø d1 (mm)	Outer-Ø d2 (mm)	Width b1 (mm)
B626A7P	A500	PEEK	PAI	6	19	6
B608A7P	A500	PEEK	PAI	8	22	7
B6000A7P	A500	PEEK	PAI	10	26	8
B6004A7P	A500	PEEK	PAI	20	42	12

Technical Data

Part number	Max. static load axial (lbs)	Static load rating (lbs)	Dynamic load rating (lbs)	Maximum speed (rpm)	Weight (g)
B626A7P	7	3	4	3,200	1.4
B608A7P	12	4	6	2,700	2.2
B6000A7P	21	5	8	2,100	3.4
B6004A7P	36	14	20	1,300	11.7

iglide® xiros®

PDF: www.igus.com/iglide-pdfs
 CAD: www.igus.com/iglide-CAD
 RoHS info: www.igus.com/RoHS

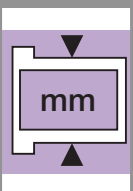
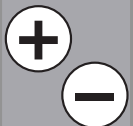



xiros® Ball Bearings C160 Material, PP Cage Stainless Steel Balls, mm

The ball bearing material iglide® C160 is cost-effective and very resistant to chemicals. iglide® C160 can be used with temperatures up to 176°F.

iglide® xiros

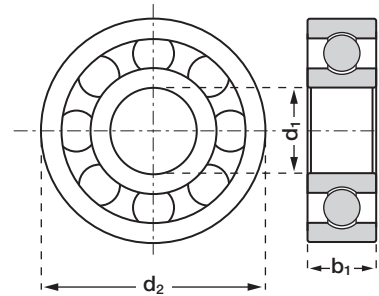

iglide® C160, PP cage, Stainless Steel Balls

Temperature range
32°F to +176°F

Telephone 1-800-521-2747
Fax 1-401-438-7270

Dimensions and materials

Part number	Race Material	Cage Material	Ball Material	Inner-Ø d1 (mm)	Outer-Ø d2 (mm)	Width b1 (mm)
B623C2E	C160	PP	316 SS	3	10	4
B626C2E	C160	PP	316 SS	6	19	6
B608C2E	C160	PP	316 SS	8	22	7
B6000C2E	C160	PP	316 SS	10	26	8

Technical Data

Part number	Max. static load axial (lbs)	Static load rating (lbs)	Dynamic load rating (lbs)	Maximum speed (rpm)	Weight (g)
B623C2E	2	4	6	4,500	0.3
B626C2E	6	9	13	2,600	2.1
B608C2E	11	11	15	2,200	3.4
B6000C2E	19	15	21	1,900	5.6

Internet: <http://www.igus.com>
email: sales@igus.com
QuickSpec: <http://www.igus.com/iglide-quickspec>

xiros® Ball Bearings

C160 Plastic Ball Bearings

PP Cage, Glass Balls, mm



xiros® plastic ball bearings in combination with a PEEK cage and glass balls are often used in environments where high chemical resistance is necessary and should be free of stainless steel components.

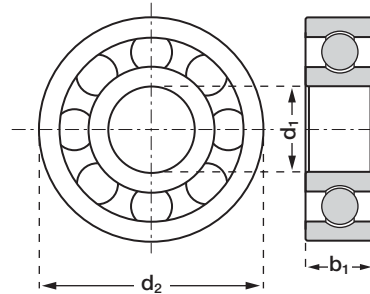

iglide® C160, PP cage, Glass Balls

Temperature range
32°F to +176°F

Dimensions and materials

Part number	Race Material	Cage Material	Ball Material	Inner-Ø d1 (mm)	Outer-Ø d2 (mm)	Width b1 (mm)
B623C2G	C160	PP	Glass	3	10	4
B626C2G	C160	PP	Glass	6	19	6
B608C2G	C160	PP	Glass	8	22	7
B6000C2G	C160	PP	Glass	10	26	8

Technical Data

Part number	Max. static load axial (lbs)	Static load rating (lbs)	Dynamic load rating (lbs)	Maximum speed (rpm)	Weight (g)
B623C2G	2	4	6	4,500	0.3
B626C2G	6	9	13	2,600	1.4
B608C2G	11	11	15	2,200	2.2
B6000C2G	19	15	21	1,900	3.5

iglide® xiros®

PDF: www.igus.com/iglide-pdfs
 CAD: www.igus.com/iglide-CAD
 RoHS info: www.igus.com/RoHS

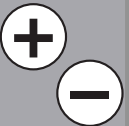



xiros® Ball Bearings B180 Material, PA Cage Stainless Steel Balls with Cover Plate

xiros® plastic ball bearings made of iglide® B180 with cover to prevent the penetration of dirt and other abrasive particles. The one-sided cover is fixed to the inner race. The other side is protected by the enclosed ball cage.

iglide® xiros



Special properties

- Dirt-repellent
- Balls protected by cover plate

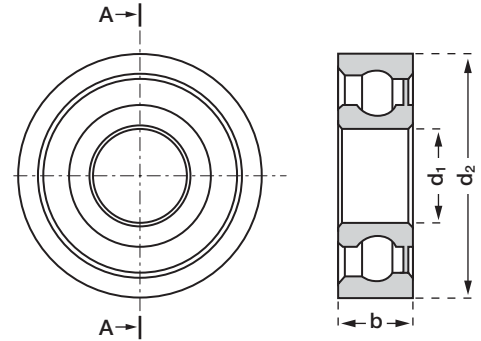

iglide® B180, PA cage, Stainless Steel Balls with Cover Plate

Temperature range
-40°F to +176°F

Telephone 1-800-521-2747
Fax 1-401-438-7270

Dimensions and materials

Part number	Race Material	Cage Material	Ball Material	Inner-Ø d1 (mm)	Outer-Ø d2 (mm)	Width b1 (mm)
BC623B1E	B180	PA	316 SS	3	10	4
BC626B1E	B180	PA	316 SS	6	19	6
BC608B1E	B180	PA	316 SS	8	22	7
BC6000B1E	B180	PA	316 SS	10	26	8
BC6001B1E	B180	PA	316 SS	12	28	8
BC6003B1E	B180	PA	316 SS	17	35	10
BC6004B1E	B180	PA	316 SS	20	42	12

Technical Data

Part number	Max. static load axial (lbs)	Static load rating (lbs)	Dynamic load rating (lbs)	Maximum speed (rpm)	Weight (g)
BC623B1E	7	6	8	4,500	0.4
BC626B1E	21	11	16	2,600	2.5
BC608B1E	37	13	19	2,200	4.0
BC6000B1E	64	19	27	1,900	6.3
BC6001B1E	71	24	33	1,750	7.1
BC6003B1E	81	40	56	1,400	11.5
BC6004B1E	90	47	66	1,150	19.7

Internet: <http://www.igus.com>
 email: sales@igus.com
 QuickSpec: <http://www.igus.com/iglide-quickspec>

xiros® Ball Bearings

B180 Material, PA Cage

Glass Balls with Cover Plate



xiros® plastic ball bearings made of iglide® B180 with cover to prevent the penetration of dirt and other abrasive particles. The one-sided cover is fixed to the inner race. The other side is protected by the enclosed ball cage.



Special properties

- Dirt-repellent
- Balls protected by cover plate

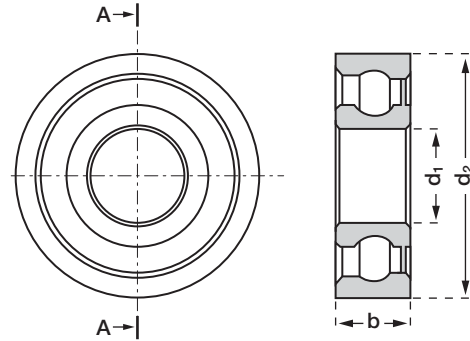

iglide® B180, PA cage, Stainless Steel Balls with Cover Plate

Temperature range
-40°F to +176°F

Dimensions and materials

Part number	Race Material	Cage Material	Ball Material	Inner-Ø d1 (mm)	Outer-Ø d2 (mm)	Width b1 (mm)
BC623B1G	B180	PA	Glass	3	10	4
BC626B1G	B180	PA	Glass	6	19	6
BC608B1G	B180	PA	Glass	8	22	7
BC6000B1G	B180	PA	Glass	10	26	8
BC6001B1G	B180	PA	Glass	12	28	8
BC6003B1G	B180	PA	Glass	17	35	10
BC6004B1G	B180	PA	Glass	20	42	12

Technical Data

Part number	Max. static load axial (lbs)	Static load rating (lbs)	Dynamic load rating (lbs)	Maximum speed (rpm)	Weight (g)
BC623B1G	7	6	8	4,500	0.4
BC626B1G	21	11	16	2,600	1.8
BC608B1G	37	13	19	2,200	2.7
BC6000B1G	64	19	27	1,900	4.1
BC6001B1G	71	24	33	1,750	4.7
BC6003B1G	81	40	56	1,400	8.4
BC6004B1G	90	47	66	1,150	14.2

iglide® xiros®

PDF: www.igus.com/iglide-pdfs
 CAD: www.igus.com/iglide-CAD
 RoHS info: www.igus.com/RoHS

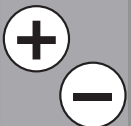



xiros® Ball Bearings B180 Slewing Ring Bearings Stainless Steel or Glass Balls

The combination of stainless steel balls with plastic inner and outer races results in maintenance-free dry operation with low coefficients of friction. The xiros® slewing ring bearing can be used in temperatures up to 176°F.

iglide® xiros



Special properties

- Lightweight
- Cost-effective

Part Number Structure

BRT 60 G

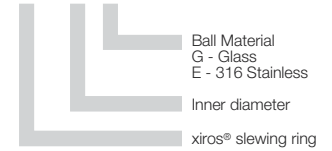

iglide® B180, PP cage,
Stainless Steel Balls

iglide® B180, PP cage,
Glass Balls

Temperature range
-40°F to +176°F

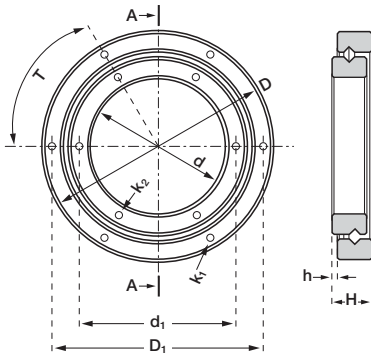

Dimensions and materials

Part number	Balls	D	D1	d	d1	H	h	T	K1 Ø	K2 Ø
Stainless Steel Balls										
BRT60E	316 SS	100	90	60	68	17.5	2.5	60	3.3	3.3
BRT100E	316 SS	160	150	100	110	20	5	60	6.4	6.4
Glass Balls										
BRT60G	Glass	100	90	60	68	17.5	2.5	60	3.3	3.3
BRT100G	Glass	160	150	100	110	20	5	60	6.4	6.4

Technical Data

Part number	Static Load (lbs)	Dynamic Load (lbs)	Max Speed (rpm)	Weight (g)
Stainless Steel Balls				
BRT60E	180	56	250	111.9
BRT100E	248	94	250	251
Glass Balls				
BRT60G	180	56	250	98.3
BRT100G	248	94	250	231

Telephone 1-800-521-2747
Fax 1-401-438-7270

Internet: <http://www.igus.com>
email: sales@igus.com
QuickSpec: <http://www.igus.com/iglide-quickspec>

xiros® Ball Bearings

B180 Material, Plastic Ball Transfer Unit



xiros® plastic ball transfer unit made of iglide® B180 for the lubricant-free transport of sensitive product. The support ball is mounted inside the housing on many smaller balls, in order to optimize the running behavior. The entire structure of the plastic ball caster consists of plastic components.



iglide® B180
POM Balls

Special properties

- Lubrication- and maintenance-free
- Corrosion-resistant and non-magnetic
- Temperature resistant up to 176°F

Temperature range
-40°F to +176°F

Part Number Structure

BT 515 B POM

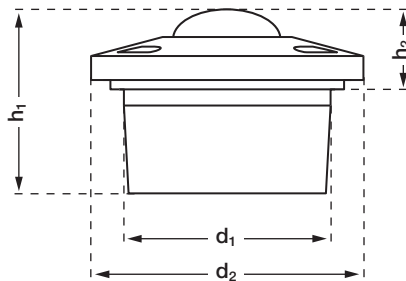
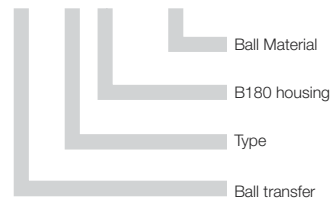

Dimensions and materials

Part number	Ball	d1	h2	d2	h1	Maximum Static Bearing Load (lbs)	Weight (g)
BT515BPOM	POM	24	9.5	31	21	18	8.7
BT522BPOM	POM	36	9.8	45	30	25	28.8

iglide® xiros®

PDF: www.igus.com/iglide-pdfs
 CAD: www.igus.com/iglide-CAD
 RoHS info: www.igus.com/RoHS

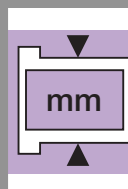
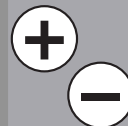



xiros® Ball Bearings

B180 Material, ESTM Pillow Block, fixed

Stainless Steel or Glass Balls, mm

iglide® xiros

Telephone 1-800-521-2747
 Fax 1-401-438-7270

Internet: <http://www.igus.com>
 email: sales@igus.com
 QuickSpec: <http://www.igus.com/iglide-quickspec>

xiros® pillow block bearings with stainless steel balls are a combination of xiros® plastic ball bearings and igubal® housings



iglide® B180, igumid G
 PA cage, Stainless Steel Balls



iglide® B180, igumid G
 PA cage, Glass Balls

Special properties

- Totally corrosion resistance
- Lubrication- and maintenance-free
- Non-magnetic and washable
- Predictable lifetime
- Compact design
- Low weight
- Electrically insulating

Temperature range

- xiros® B180, -40°F to +176 °F
- xiros® A500, -40°F to +248 °F

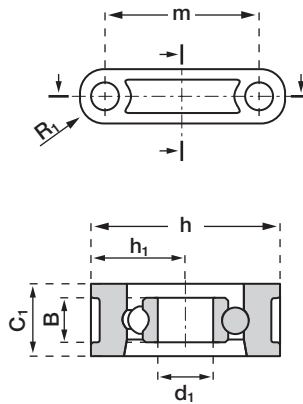

Part Number Structure

ESTM 1 F 06 B E

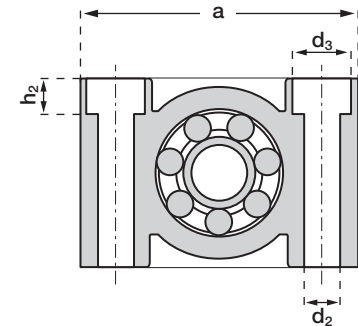
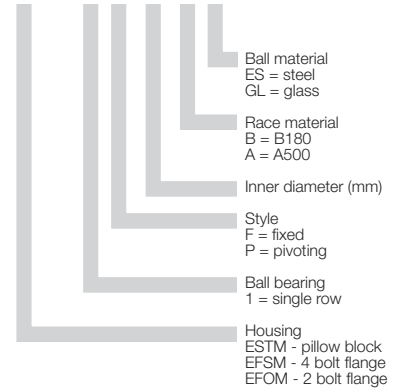

Dimensions (mm)

Part No.*	Inner Ø d	Ø Bore d2	d3	h	h1	h2	a	m	C1	B	R1
Stainless Steel Balls											
ESTM1F06BE	6	5.5	5.5	22	11	–	36	26	10	6	5.0
ESTM1F10BE	10	6.6	10.6	34	17	6.4	50	37	13	8	6.5
ESTM1F20BE	20	9.0	14.0	48	24	8.06	72	54	18	12	9.0
Glass Balls											
ESTM1F06BG	6	5.5	5.5	22	11	–	36	26	10	6	5.0
ESTM1F10BG	10	6.6	10.6	34	17	6.4	50	37	13	8	6.5
ESTM1F20BG	20	9.0	14.0	48	24	8.06	72	54	18	12	9.0

Technical Data

Part No.*	Max. Static load axial (lbs)	Static load rating (lbs)	Dynamic load rating (lbs)	Max. Speed (rpm)	Weight (g)
Stainless Steel Balls					
ESTM1F06BE	21	11	16	2,600	7.7
ESTM1F10BE	64	19	27	1,900	20.2
ESTM1F20BE	90	47	66	1,150	54.1
Glass Balls					
ESTM1F06BG	21	11	16	2,600	6.7
ESTM1F10BG	64	19	27	1,900	18.2
ESTM1F20BG	90	47	66	1,150	47.7

*For temperatures up to +248°F order with A500 material.

For example:

ESTM1F08AE with stainless steel balls

ESTM1F08AG with glass balls

xiros® Ball Bearings

B180 material, ESTM Pillow Block, pivoting

Stainless Steel or Glass Balls, mm



xiros® pillow block bearings with stainless steel balls are a combination of xiros® plastic ball bearings and igubal® housings. The pivoting option allows for the compensation of misalignments.



iglide® B180, igumid G
PA cage, Stainless Steel Balls



iglide® B180, igumid G
PA cage, Glass Balls

Special properties

- Totally corrosion resistance
- Lubrication- and maintenance-free
- Non-magnetic and washable
- Predictable lifetime
- Compact design
- Low weight
- Electrically insulating

Temperature range

- xiros® B180, -40°F to +176 °F
- xiros® A500, -40°F to +248 °F

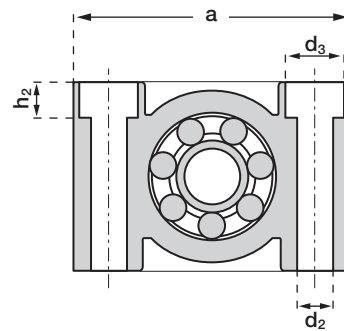
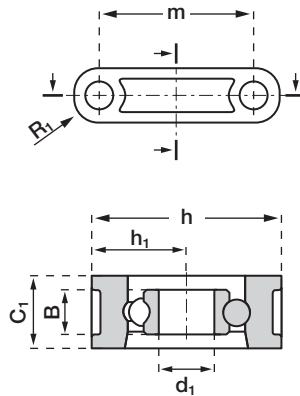

Part Number Structure

ESTM 1 F 06 B E

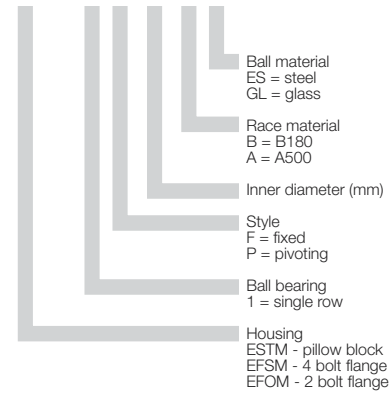

Dimensions (mm)

Part No.*	Inner Ø d	Ø Bore d2	d3	h	h1	h2	a	m	C1	B	R1
Stainless Steel Balls											
ESTM1P08BE	8	6.6	10.6	34	17	6.4	50	37	13	7	6.5
ESTM1P10BE	10	9.0	14.0	40	20	8.6	62	46	16	8	8.0
ESTM1P12BE	12	9.0	14.0	48	24	8.6	72	54	18	10	9.0
Glass Balls											
ESTM1P08BG	8	6.6	10.6	34	17	6.4	50	37	13	7	6.5
ESTM1P10BG	10	9.0	14.0	40	20	8.6	62	46	16	8	8.0
ESTM1P12BG	12	9.0	14.0	48	24	8.6	72	54	18	10	9.0

Technical Data

Part No.*	Max. Static load axial (lbs)	Static load rating (lbs)	Dynamic load rating (lbs)	Max. Speed (rpm)	Max. Pivoting Angle	Weight (g)
Stainless Steel Balls						
ESTM1P08BE	37	13	19	2,200	5°	19.6
ESTM1P10BE	64	19	27	1,900	5°	32.9
ESTM1P12BE	70	24	33	1,750	5°	54.8
Glass Balls						
ESTM1P08BG	37	13	19	2,200	5°	18.2
ESTM1P10BG	64	19	27	1,900	5°	30.3
ESTM1P12BG	70	24	33	1,750	5°	52.8

*For temperatures up to +248°F order with A500 material.

For example:

ESTM1P08AE with stainless steel balls

ESTM1P08AG with glass balls

iglide® xiros®

PDF: www.igus.com/iglide-pdfs
 CAD: www.igus.com/iglide-CAD
 RoHS info: www.igus.com/RoHS

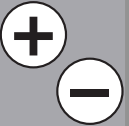



xiros® Ball Bearings

EFSM 4-Bolt Flange, B180 Material

Stainless Steel or Glass Balls, mm

xiros® flange bearings with stainless steel or glass balls are a combination of xiros® plastic ball bearings and igubal® housings. The new angle-compensating xiros® was developed for the maintenance-free application in conveyor belts, cam rollers and support housings. The light, corrosion-free and anti-magnetic bearing needs no oil or grease and compensates for misalignments caused by tiltings and/or tolerances

iglide® xiros



iglide® B180, igumid G
PA cage, Stainless Steel Balls
or Glass Balls

Temperature range

- xiros® B180, -40°F to +176 °F
- xiros® A500, -40°F to +248 °F

Special properties

- Compensation for misalignments
- Totally corrosion resistant
- Lubrication- and maintenance-free
- Non-magnetic and washable
- Predictable lifetime
- Compact design
- Low weight
- Electrically insulating

Part Number Structure

EFSM 1 F 06 B E

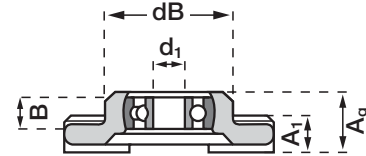
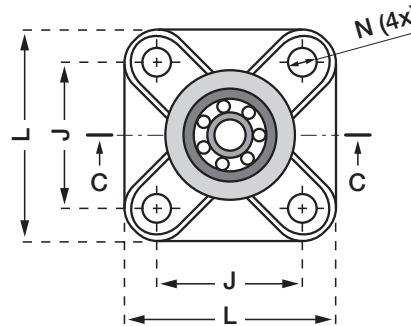
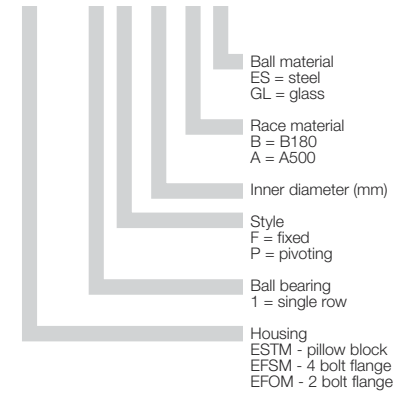

Dimensions (mm)

Part No.*	Inner Ø d1	dB	L	J	A1	Ag	N	Max. Pivoting angle
Stainless Steel Balls								
EFSM1P08BE	8	32.5	52	36	9	15.5	6.4	5°
EFSM1P10BE	10	40.0	65	45	11	18.8	8.4	5°
EFSM1P12BE	12	48.0	74	52	14	23.5	8.4	5°
Glass Balls								
EFSM1P08BG	8	32.5	52	36	9	15.5	6.4	5°
EFSM1P10BG	10	40.0	65	45	11	18.8	8.4	5°
EFSM1P12BG	12	48.0	74	52	14	23.5	8.4	5°

Technical Data

Part No.*	Max. Static load axial (lbs)	Static load rating (lbs)	Dynamic load rating (lbs)	Max. Speed (rpm)	Weight (g)
Stainless Steel Balls					
EFSM1P08BE	37	13	19	2,200	25.2
EFSM1P10BE	64	19	27	1,900	48.8
EFSM1P12BE	70	24	33	1,750	80.0
Glass Balls					
EFSM1P08BG	37	13	19	2,200	25.2
EFSM1P10BG	64	19	27	1,900	48.8
EFSM1P12BG	70	24	33	1,750	80.0

*For temperatures up to +248°F order with A500 material.

For example:

- EFSM1P08AE with stainless steel balls
- EFSM1P08AG with glass balls

Telephone 1-800-521-2747
Fax 1-401-438-7270

Internet: <http://www.igus.com>
email: sales@igus.com
QuickSpec: <http://www.igus.com/iglide-quickspec>

xiros® Ball Bearings

EFOM 2-Bolt Flange

B180 Material, Stainless Steel or Glass Balls, mm



xiros® flange bearings with stainless steel or glass balls are a combination of xiros® plastic ball bearings and igubal® housings. The new angle-compensating xiros® was developed for the maintenance-free application in conveyor belts, cam rollers and support housings. The light, corrosion-free and anti-magnetic bearing needs no oil or grease and compensates for misalignments caused by tiltings and/or tolerances



iglide® B180, igumid G
PA cage, Stainless Steel Balls
or Glass Balls

Temperature range

- xiros® B180, -40°F to +176 °F
- xiros® A500, up to +248 °F

Special properties

- Compensation for misalignments
- Totally corrosion resistant
- Lubrication- and maintenance-free
- Non-magnetic and washable
- Predictable lifetime
- Compact design
- Low weight
- Electrically insulating

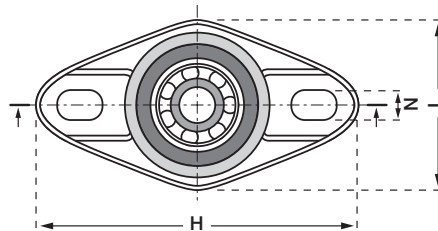

Part Number Structure

EFOM 1 F 06 B E

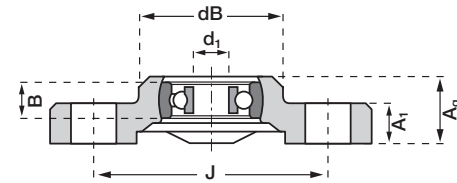
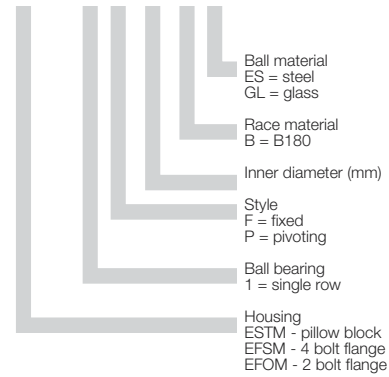

Dimensions (mm)

Part No.*	Inner Ø d1	dB	L	J	A1	Ag	N	Max. Pivoting angle
Stainless Steel Balls								
EFOM1P08BE	8	32	72.6	38	10	15,5	6.4 x 10.1	5°
EFOM1P10BE	10	40	89.0	47	11	18,8	8.4 x 12.5	5°
EFOM1P12BE	12	48.5	101.0	58.5	14	23,5	8.4 x 12.5	5°
Glass Balls								
EFOM1P08BG	8	32	72.6	38	10	15,5	6.4 x 10.1	5°
EFOM1P10BG	10	40	89.0	47	11	18,8	8.4 x 12.5	5°
EFOM1P12BG	12	48.5	101.0	58.5	14	23,5	8.4 x 12.5	5°

Technical Data

Part No.*	Max. static load axial (lbs)	Static load rating (lbs)	Dynamic load rating (lbs)	Maximum speed (rpm)
Stainless Steel Balls				
EFOM1P08BE	37	13	19	2,200
EFOM1P10BE	64	19	27	1,900
EFOM1P12BE	70	24	33	1,750
Glass Balls				
EFOM1P08BG	37	13	19	2,200
EFOM1P10BG	64	19	27	1,900
EFOM1P12BG	70	24	33	1,750

*For temperatures up to +248°F order with A500 material.

For example:

EFOM1P08AE with stainless steel balls

EFOM1P08AG with glass balls

iglide® xiros®

PDF: www.igus.com/iglide-pdfs
CAD: www.igus.com/iglide-CAD
RoHS info: www.igus.com/RoHS

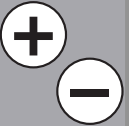



iglide® xiros

Telephone 1-800-521-2747
Fax 1-401-438-7270

Internet: <http://www.igus.com>
email: sales@igus.com
QuickSpec: <http://www.igus.com/iglide-quickspec>

iglide® A500	Unit	Medium	Resistance
Density	1,28 g/cm ³	Alcohol	+
Color	brown	Hydrocarbons	+
Saturation with moisture absorption at 23°C/50% r.h.	0,3 % weight	Grease, oils without additives	+
Saturation with water	0,5% weight	Fuels	+
Modulus of elasticity	522,100	Diluted acids	+
Max. permissible surface pressure at 20 °C	20,300	Strong acids	+
Shore D hardness	83	Diluted alkalines	+
Specific volume resistance	> 10 ¹⁴ Ωcm	Strong alkalines	+
Surface resistivity	> 10 ¹³ Ω		

iglide® B180	Unit	Medium	Resistance
Density	1,49 g/cm ³	Alcohol	+
Color	yellow	Hydrocarbons	+
Saturation with moisture absorption at 23°C/50% r.h.	0,3 % weight	Grease, oils without additives	+
Saturation with water	1,3 % weight	Fuels	+
Modulus of elasticity	348,090	Diluted acids	0 to -
Max. permissible surface pressure at 20 °C	10,587	Strong acids	-
Shore D hardness	74	Diluted alkalines	+
Specific volume resistance	> 10 ¹³ Ωcm	Strong alkalines	+ to 0
Surface resistivity	> 10 ¹² Ω		

iglide® C160	Unit	Medium	Resistance
Density	1,11 g/cm ³	Alcohol	+
Color	white	Hydrocarbons	+ to 0
Saturation with moisture absorption at 23°C/50% r.h.	0,1 % weight	Grease, oils without additives	+
Saturation with water	0,2 % weight	Fuels	+ to 0
Modulus of elasticity	275,571	Diluted acids	+
Max. permissible surface pressure at 20 °C	5,076	Strong acids	+ to 0
Shore D hardness	non defined	Diluted alkalines	+
Specific volume resistance	> 10 ¹⁴ Ωcm	Strong alkalines	+
Surface resistivity	> 10 ¹⁴ Ω		

igumid G	Unit	Medium	Resistance
Density	1,37 g/cm ³	Alcohol	+ to 0
Color	black	Hydrocarbons	+
Saturation with moisture absorption at 23°C/50% r.h.	1,4 % weight	Grease, oils without additives	+
Saturation with water	5,6 % weight	Fuels	+
Modulus of elasticity	1,131,294	Diluted acids	0
Max. permissible surface pressure at 20 °C	34,809	Strong acids	-
Shore D hardness	79	Diluted alkalines	+
Specific volume resistance	> 10 ¹¹ Ωcm	Strong alkalines	0
Surface resistivity	> 10 ¹¹ Ω		



iglide® xiros®

PDF: www.igus.com/iglide-pdfs
CAD: www.igus.com/iglide-CAD
RoHS info: www.igus.com/RoHS

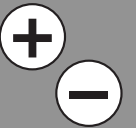



iglide® xiros

Telephone 1-800-521-2747
Fax 1-401-438-7270

Internet: <http://www.igus.com>
email: sales@igus.com
QuickSpec: <http://www.igus.com/iglide-quickspec>

igus[®]



iglide[®] PRT



iglide® Bearings PRT - Technical Data

Product Range

- Available in 3 Styles
- Inner diameters:
Metric sizes from 20 - 300 mm

Part Number Structure

Part Number Structure

PRT - 01 - 30 - ES

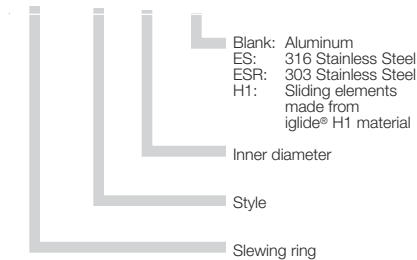

Maximum Speed

Part No.	Max rpm
PRT-02-20	250
PRT-02-30	200
PRT-02-60	120
PRT-01-20	300
PRT-01-30	250
PRT-01-60	200
PRT-01-100	150
PRT-01-150	100
PRT-01-200	80
PRT-01-300	50

Usage Guidelines



- When a ready-to-install solution is needed
- When a robust and corrosion resistant bearing unit with high load capacity is needed
- For high moments
- For use in dirty environments
- For maintenance-free applications without lubrication
- For slow to medium speeds



- For fast rotations
- When there is not enough driving torque at high loads
- When extreme precision is needed

iglide® PRT is a slewing ring bearing with the proven advantage of iglus® plastic bearings. The iglide® J sliding elements are completely maintenance-free and lubrication-free. All the housing components are made of aluminum (except style 02, which has iglide® J4 head rings), and all the parallel surfaces of iglide® J sliding elements are hard anodized. All the fixing screws are made of stainless steel. The PRT slewing rings are available on request in stainless steel.



Load

iglide® PRT slewing rings have varying load capacities depending on the type of load. All data can be used for both horizontal and lateral assembly. For cantilevered loads please see eccentric load chart on page 17.3 for required torque. Also feel free to contact our technical sales department for any application assistance.

See the chart on page 17.3 for load capabilities of the standard -01 version and page 17.5 for the load capabilities of the lightweight -02 version.

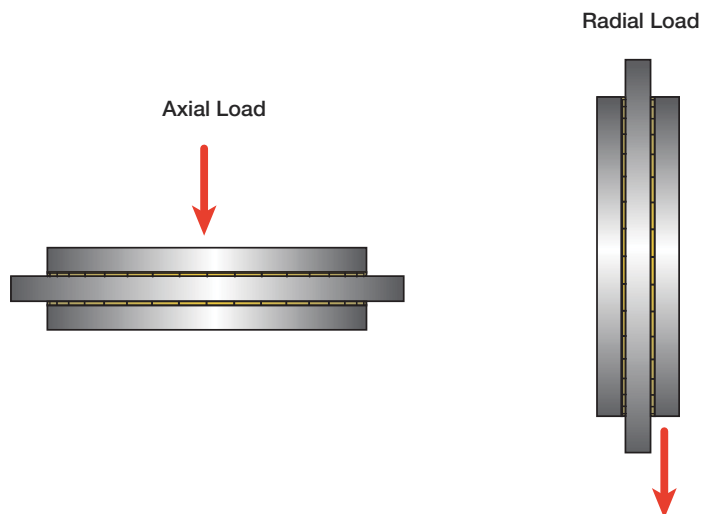



Dimensions

Part No.	Weight lbs	Axial Load		Radial Load		Max. rpm dry 1/rpm	Rigidity		Max. Perm. tilting moment lbs*ft
		static lbs	dynamic lbs	static lbs	dynamic lbs		axial N/μm	radial N/μm	
PRT-01-20	0.40	3370	900	517	135	300	80	10	73
PRT-01-30	0.88	6,070	1,573	1,124	337	250	100	50	147
PRT-01-60	2.43	11,240	3,372	2,248	674	200	300	65	590
PRT-01-100	2.87	12,364	3,596	3,596	1,124	150	400	65	1,106
PRT-01-150	4.85	17,984	5,620	5,620	1,798	100	450	65	1,475
PRT-01-200	7.05	22,480	6,744	7,868	2,248	80	500	65	2,802
PRT-01-300	16.75	33,721	20,232	10,116	6,069	50	500	65	3,687

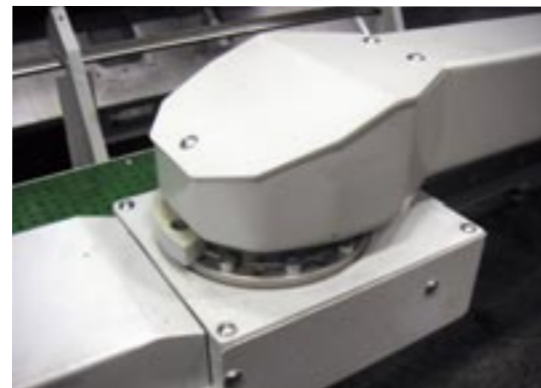
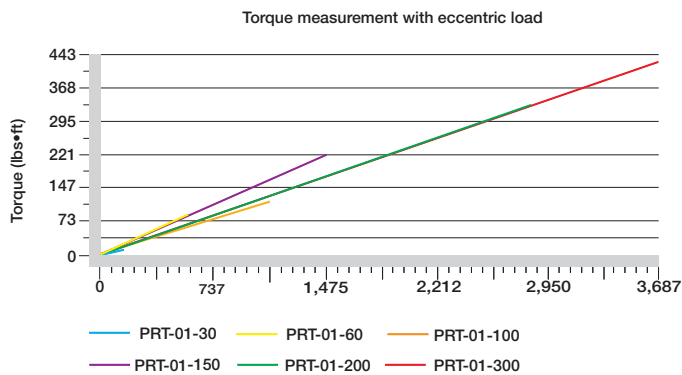

PRT in CNC machine

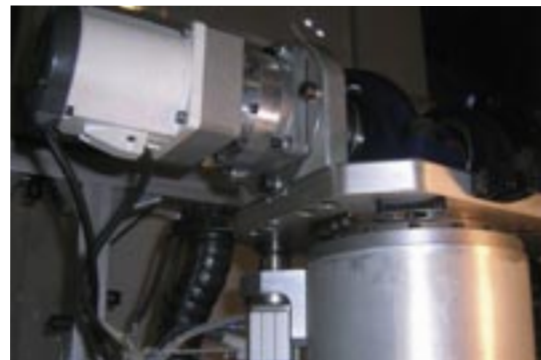
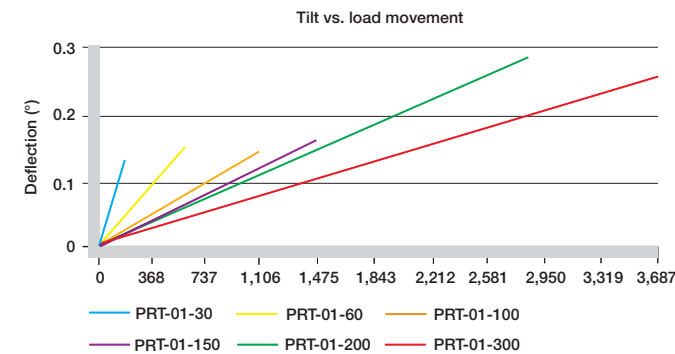

PRT in welding plant

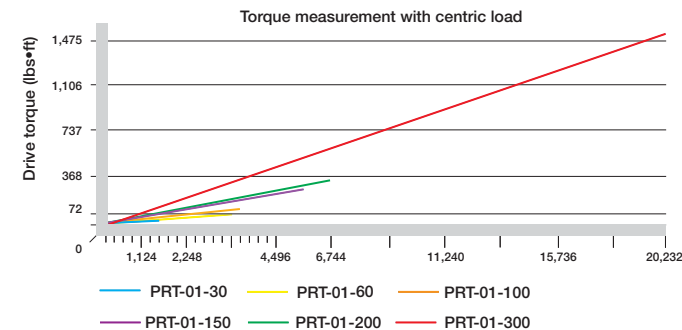

All load values assume the PRT is assembled with socket head screws (strength class 8.8) on the outside pitch circle diameter. For the assembly of the PRT the screws have to be inserted to a minimum thread depth of 2x the amount of the bores in the outer ring.

- PRT-01-20: M4, min. 6 screws
- PRT-01-30: M4, min. 8 screws
- PRT-01-60: M5, min. 10 screws
- PRT-01-100: M5, min. 12 screws
- PRT-01-150: M5, min. 12 screws
- PRT-01-200: M6, min. 12 screws
- PRT-01-300: M8, min. 12 screws

All data can be used for both lateral and horizontal assembly.

iglide® PRT

PDF: www.igus.com/iglide-pdfs
CAD: www.igus.com/iglide-CAD
RoHS info: www.igus.com/RoHS





iglide® PRT

Telephone 1-800-521-2747
 Fax 1-401-438-7270

Internet: <http://www.igus.com>
 email: sales@igus.com
 QuickSpec: <http://www.igus.com/iglide-quickspec>



PRT-01-300

Advantages

- High rigidity
- Easy to install, iglide® J sliding pads
- High wear resistance
- Available in aluminum or stainless steel

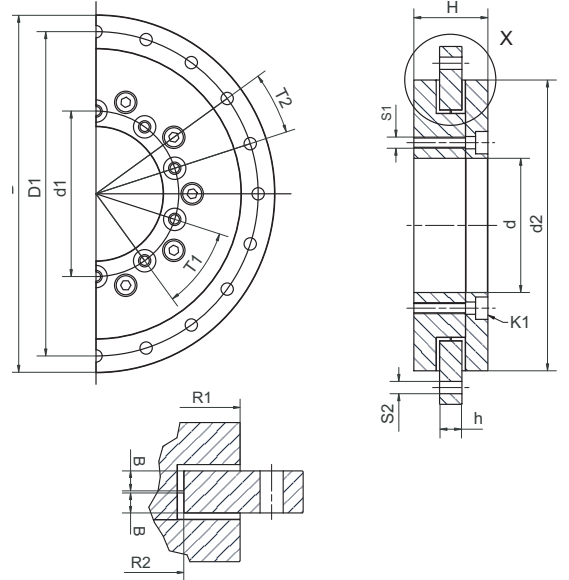
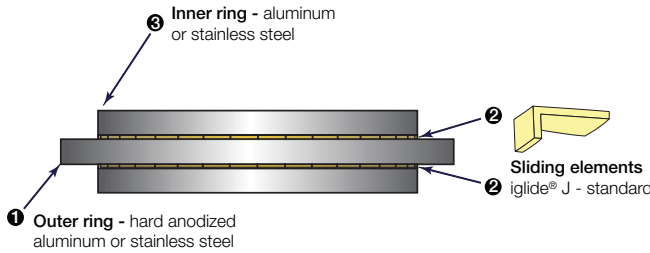

Dimensions (mm)

Part No.	D*	D1	d1	d	d2	H	h	T1	T2	S1	S2	K1	R1	R2	B
					±0.2							for screw			
PRT-01-20	80	70	31	20	60	24	8	3 x 120°	6 x 60°	M4	4.5	DIN 7984 M4	30	20	3.5
PRT-01-30	100	91	42.5	30	82	29	10	8 x 45°	8 x 45°	M4	4.5	DIN 7984 M4	41	29	4.5
PRT-01-60	160	145	74	60	130	33	10	10 x 36°	20 x 18°	M5	5.5	DIN 912 M5	65	51.5	4.5
PRT-01-100	185	170	112	100	160	34	12	12 x 30°	16 x 22.5°	M5	5.5	DIN 912 M5	80	69	5.5
PRT-01-150	250	235	165	150	220	35	12	12 x 30°	16 x 22.5°	M5	5.5	DIN 912 M5	110	96.5	5.5
PRT-01-200	300	285	215	200	274	38	15	12 x 30°	16 x 22.5°	M6	6.6	DIN 912 M6	137	124	7.0
PRT-01-300	450	430	320	300	410	42	15	12 x 30°	16 x 22.5°	M8	9.0	DIN7984M8	205	186.6	7.0

To order the 316 stainless steel option please add the suffix 'ES' to the end of the part number. Example: PRT-01-60ES
 To order the 303 stainless steel option please add the suffix 'ESR' to the end of the part number. Example: PRT-01-60ESR (standard stainless option. Other options are available, please call iglus® for more information. *Tolerance according to DIN ISO 2768 mK

iglide® PRT Slewing Ring Bearing, High Temperature, Style 01



Advantages

- Suitable up to 356°F, high chemical resistance
- For all 7 standard dimensions of style 01
- Body in aluminum or stainless steel, sliding parts in iglide® H1

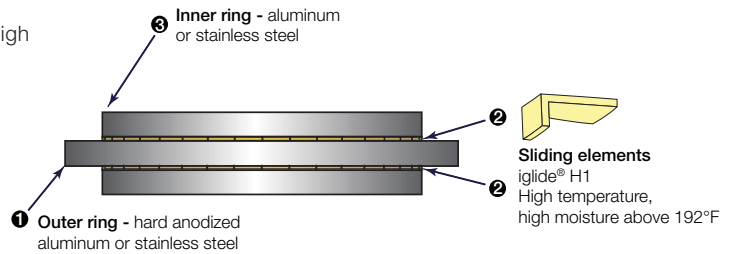

Dimensions [mm]

Part No.	D*	D1	d1	d	d2	H	h	T1	T2	S1	S2	K1	R1	R2	B
					±0.2							for screw			
PRT-01-20-H1	80	70	31	20	60	24	8	3 x 120°	6 x 60°	M4	4.5	DIN 7984 M4	30	20	3.5
PRT-01-30-H1	100	91	42.5	30	82	29	10	8 x 45°	8 x 45°	M4	4.5	DIN 7984 M4	41	29	4.5
PRT-01-60-H1	160	145	74	60	130	33	10	10 x 36°	20 x 18°	M5	5.5	DIN 912 M5	65	51.5	4.5
PRT-01-100-H1	185	170	112	100	160	34	12	12 x 30°	16 x 22.5°	M5	5.5	DIN 912 M5	80	69	5.5
PRT-01-150-H1	250	235	165	150	220	35	12	12 x 30°	16 x 22.5°	M5	5.5	DIN 912 M5	110	96.5	5.5
PRT-01-200-H1	300	285	215	200	274	38	15	12 x 30°	16 x 22.5°	M6	6.6	DIN 912 M6	137	124	7.0
PRT-01-300-H1	450	430	320	300	410	42	15	12 x 30°	16 x 22.5°	M8	9.0	DIN 7984 M8	205	186.6	7.0

To order the H1 with 316 stainless steel option please add the suffix 'HES' to the end of the part number. Example: PRT-01-60HES
 To order the H1 with 303 stainless steel option please add the suffix 'HESR' to the end of the part number. Example: PRT-01-60HESR (standard stainless option.* Tolerance according to DIN ISO 2768 mK

iglide® Bearings PRT - Slewing Ring Bearing, Style 02



Advantages

- Lightweight (.44 lbs.)
- Outer ring made from hard anodized Aluminum or stainless steel
- iglide® J4 inner rings – sliding against the outer ring without lubrication
- Low cost



Outer ring available in stainless steel as an option. Inner rings made from iglide® J4

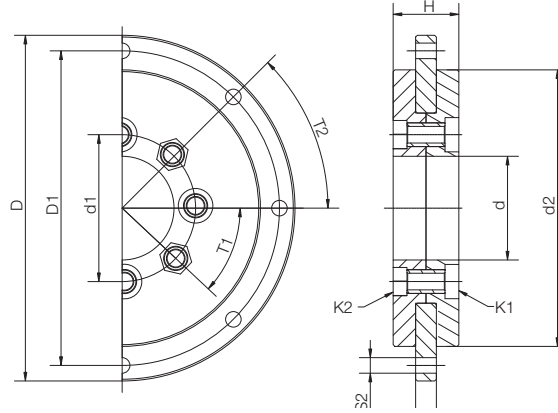
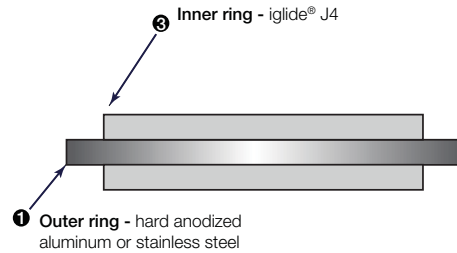

Dimensions (mm)

Part No.	D	D1	d1	d	d2	H	h	T1	T2	S2	K1 For Screw	K2 For Screw
PRT-02-20-AL	80	70	31	20	60	16	5	6 x 60°	6 x 60°	4.5	DINB6912-172 M5	DIN439-A2 M5
PRT-02-30-AL	100	91	42.5	30	80	19	6	8 x 45	8x45	4.5	DIN 7984 M5	DIN 439 M5A2
PRT-02-60-AL	160	145	86.5	60	130	30	10	6 x 60°	20 x 18°	5.5	DIN931 M5x25	DIN934 M5

Please add "ES" to the Part No. for stainless steel (316 SS)

Properties	Unit	PRT-02-20-AL	PRT-02-30-AL	PRT-02-60-AL
Weight	lbs	0.22	0.44	1.54
Max. axial load, static	lbf	2,923	5620	10116
Max. axial load, dynamic	lbf	899	1574	2698
Max. radial load, static	lbf	450	562	2248
Max. radial load, dynamic	lbf	112	157	630
Max. rotational speed dry running	1/min	250	200	120
Max. permissible tilting moment	lbs•ft	45	74	148

PRT - Slewing Ring Bearing, FDA Compliant, Style 02



Advantages

- For use in the food technology with inner rings made from FDA-compliant material iglide® A180
- The stainless steel outer ring and the material iglide® A180 are suitable for the direct contact with food, pharmaceuticals and humidity.
- Low profile and low weight
- Easy to install
- Totally lubrication-free

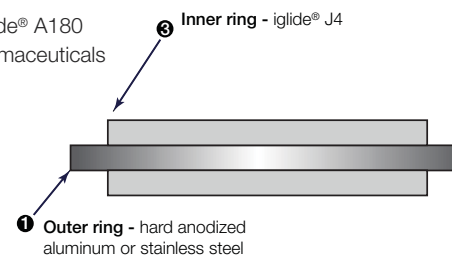

Dimensions [mm]

Part No.	D	D1	d1	d	d2	H	h	T1	T2	S2	K1 for screw	K2 for screw
PRT-02-30-ES-A180	100	91	42.5	30	80	19	6	8x45	8x45	4.5	DIN 7984 M5	DIN 439-A2 M5

PDF: www.igus.com/iglide-pdfs
CAD: www.igus.com/iglide-CAD
RoHS info: www.igus.com/RoHS

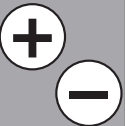

iglide® PRT



iglide® PRT

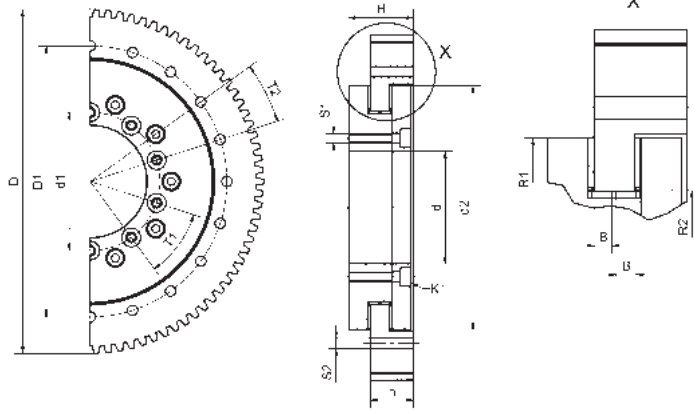

Geared PRT's are now the standard for driving a PRT by belt, rack, or pinion gear. There are 4 different gear options offered in hard anodized aluminum.

- Maintenance- and lubrication-free
- Ready to fit
- Robust and corrosion-resistant

Telephone 1-800-521-2747
 1-401-438-7270
 Fax

Dimensions (mm)

Part No.	D1 (mm)	d1 (mm)	d (mm)	d2 (mm)	h (mm)	T1 (°)	T2 (°)	S1	S2	K1	R1 (mm)	R2 (mm)	B (mm)	H (mm)
PRT-30- <input type="text"/>	91	42.5	30	82	21	8 x 45	8 x 45	M4	4.5	DIN 912 M4	41	29.0	4.5	(30.4)
PRT-60- <input type="text"/>	145	74.0	60	130	23	10 x 36	20 x 18	M5	5.5	DIN 912 M5	65	51.5	4.5	(34.5)
PRT-100- <input type="text"/>	170	112.0	100	160	25	12 x 30	16 x 22.5	M5	5.5	DIN 912 M5	80	69.0	5.5	(36.0)
PRT-150- <input type="text"/>	235	165.0	150	220	25	12 x 30	16 x 22.5	M5	5.5	DIN 912 M5	110	96.5	5.5	(37.5)
PRT-200- <input type="text"/>	285	215.0	200	274	30	12 x 30	16 x 22.5	M6	7.0	DIN 912 M6	137	124.0	7.0	(41.5)
PRT-300- <input type="text"/>	430	320.0	300	410	30	12 x 30	16 x 22.5	M8	9.0	DIN 912 M8	205	186.5	8.5	(46.5)

Fill in the box with the required toothed belt profile from below.
 Example: PRT-30-ST

Spur gearing DIN 3967
(ST)

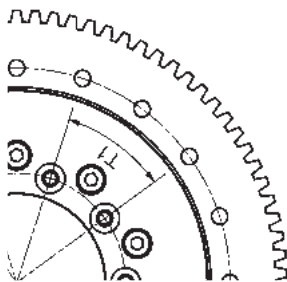

Part No.	m modulus	z # of Teeth	D (mm)
...-ST	2	54	(112)
...-ST	2	90	(184)
...-ST	2	96	(196)
...-ST	2	126	(256)
...-ST	2	152	(308)
...-ST	3	152	(462)

Toothed belt profile
(AT10)

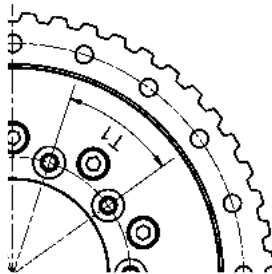

Part No.	z # of Teeth	D (mm)
...-AT10	34	(106.4)
...-AT10	52	(163.8)
...-AT10	60	(189.2)
...-AT10	80	(252.9)
...-AT10	96	(303.9)
...-AT10	144	(456.7)

Toothed belt profile
(T10)

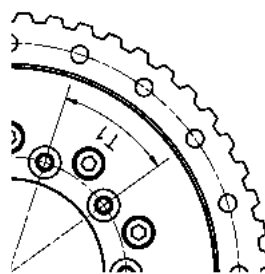

Part No.	z # of Teeth	D (mm)
...-T10	34	(106.4)
...-T10	52	(163.8)
...-T10	60	(189.2)
...-T10	80	(252.9)
...-T10	96	(303.9)
...-T10	144	(456.7)

Toothed belt profile
(HTD8M)

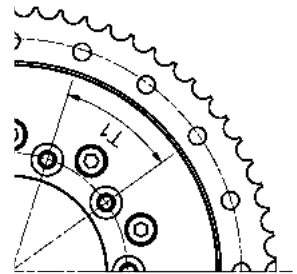

Part No.	z # of Teeth	D (mm)
...-HTD8M	42	(105.6)
...-HTD8M	66	(166.7)
...-HTD8M	72	(189.2)
...-HTD8M	100	(253.3)
...-HTD8M	120	(304.3)
...-HTD8M	180	(457.1)

Internet: <http://www.igus.com>
 email: sales@igus.com
 QuickSpec: <http://www.igus.com/iglide-quickspec>



Drive plate



- For quick and easy drive coupling

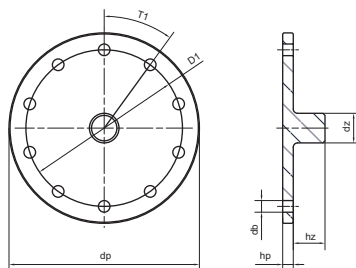

Picture shows PRT with fitted drive plate

Part No.	dp (mm)	hp (mm)	dz (mm)	hz (mm)	D1 (mm)	T1 (°)	db (mm)
PRT-AZ-30	55	5	10	15	42.5	8 x 45	4.5
PRT-AZ-60	90	5	14	15	74	10 x 36	5.5
PRT-AZ-100ES	125	8	20	20	112	12 x 30°	5.5
PRT-AZ-150ES	180	10	20	20	165	12 x 30	4.5
PRT-AZ-200ES	230	10	20	20	215	12 x 30	7

Distance rings for the -100, -150 and the -200 are made from 303SS to meet their load capacity

Mounting rings



- Easier, more flexible mounting
- No bore in the mounting face necessary

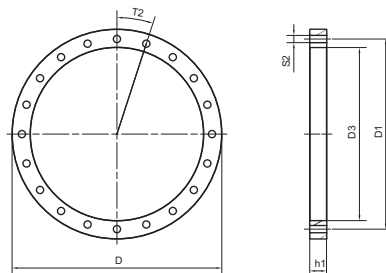

Picture shows PRT with fitted distance ring

Part No.	D (mm)	D1 (mm)	T2 (°)	S2 (mm)	D3 (mm)	h1 (mm)
PRT-01-30-DR	100	91	8 x 45	4.5	84	11
PRT-01-60-DR	160	145	20 x 18	5.5	132	13
PRT-01-100-DR	185	170	16 x 22.5	5.5	162	13
PRT-01-150-DR	250	235	16 x 22.5	5.5	222	13
PRT-01-200-DR	300	285	16 x 22.5	7.0	276	13
PRT-01-300-DR	450	430	16 x 22.5	9.0	412	15

Plastic Mounting rings

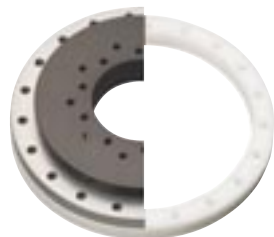

- Lightweight
- No bore in the mounting face necessary

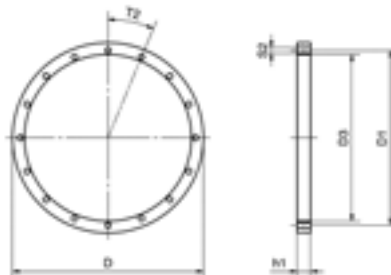

Part No.	D (mm)	D1 (mm)	T2 (°)	S2 (mm)	D3 (mm)	h1 (mm)
PRT-01-30-DRP	100	91	8 x 45	4.5	84	11
PRT-01-60-DRP	160	145	20 x 18	5.5	132	13
PRT-01-100-DRP	185	170	16 x 22.5	5.5	162	13

PDF: www.igus.com/iglide-pdfs
CAD: www.igus.com/iglide-CAD
RoHS info: www.igus.com/RoHS

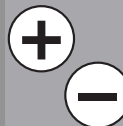



iglide® PRT

Hand clamp

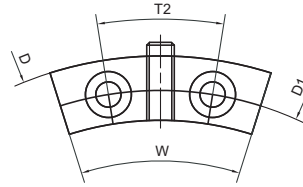
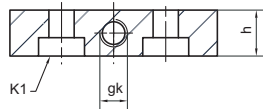

Picture shows PRT with fitted manual clamp

- With .75 lbs · ft screw torque a holding torque up to 7lbs · ft is possible
- Easy to screw onto outer ring

Part No.	D (mm)	D1 (mm)	T2 (°)	K1	h (mm)	gk	W (°)
PRT-HK-60	160	145	20 x 18	DIN 7984 M5	10	M6	35
PRT-HK-100*	205	185	16 x 22.5	DIN 7984 M5	12	M6	40
PRT-HK-200*	320	300	16 x 22.5	DIN 7984 M6	15	M6	40

* Required with large outer rings

PRT with Large outer ring

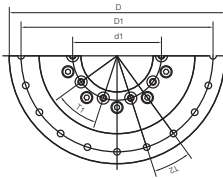

Part No.	D (mm)	D1 (mm)	d1 (mm)	T1 (°)	T2 (°)
PRT-01-100-G	205	185	112	12 x 30	16 x 22.5
PRT-01-200-G	320	300	215	12 x 30	16 x 22.5

Telephone 1-800-521-2747
Fax 1-401-438-7270

Internet: <http://www.igus.com>
email: sales@igus.com
QuickSpec: <http://www.igus.com/iglide-quickspec>



iglide® PRT

PDF: www.igus.com/iglide-pdfs
CAD: www.igus.com/iglide-CAD
RoHS info: www.igus.com/RoHS





iglide® Bearings PRT - Notes

iglide® PRT

Telephone 1-800-521-2747
Fax 1-401-438-7270

Internet: <http://www.igus.com>
email: sales@igus.com
QuickSpec: <http://www.igus.com/iglide-quickspec>

igus[®]



iglide[®] Clip



Product Range

- Inner diameters:
Inch sizes from 3/16 - 1 in.
Metric sizes from 3 - 25 mm
- For sheet metal thicknesses:
Inch sizes from .040 - .135 in.
Metric sizes from 2, 3 and 4mm

Part Number Structure

Part Number Structure

M C I - 03 - 04

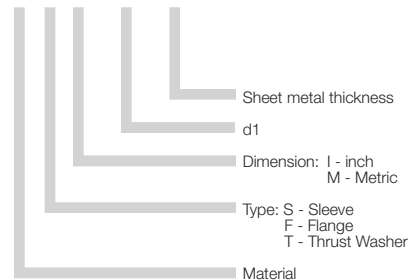

Permissible Surface Speeds

	Continuous fpm	Short Term fpm
Rotating	157	393
Oscillating	118	275
Linear	492	984

Advantages

- Secured with the double flange design
- Maintenance-free and self-lubricating
- Good wear resistance
- Smooth operation
- Low noise
- Used for both rotational and linear movements
- Expansion possible due to slot design
- Material: iglide® M250

Special Properties

iglide clip bearings are manufactured out of the wear-resistant material iglide M250. iglide M250 is a plain bearing material with strong wear-resistance at average loads. The bearings are self-lubricating and can be used dry. The bearings can be lubricated if desired. The iglide M250 material is resistant to all common lubricants.



Visit www.igus.com to use our online expert system

iglide® clip bearings are designed specifically for putting shafts through sheet metal plates. For this reason, the bearings have flanges located on both ends. The bearings are secured in the sheet metal plate on both sides after installation.

The clip bearings are slit at an angle, so installation of the bearings is possible from one side. After installation, the bearing opens and forms a lining for the bore hole in the metal plate. The shaft prevents the clip bearing from detaching from the housing. Even during axial movement, the bearing remains secured in the housing.

In addition, the lateral slit can compensate for bearing expansions due to temperature or moisture. During expansion, the slit width decreases, and changes so the bearing clearance is minimized.

The flange diameter on the smaller side is made to ensure that housings with larger tolerances can be properly secured.

Material Table

General Properties	Unit	iglide® M250	Testing Method
Density	g/cm ³	1.14	
Color		charcoal	
Max. moisture absorption at 73°F / 50% r.h.	% weight	1.4	DIN 53495
Max. moisture absorption	% weight	7.6	
Coefficient of friction, dynamic against steel	μ	0.1 - 0.3	
p x v value, max. (dry)	psi x fpm	3,400	

Mechanical Properties

Modulus of elasticity	psi	391,600	DIN 53457
Tensile strength at 68°F	psi	16,240	DIN 53452
Compressive strength	psi	7,540	
Permissible static surface pressure (68°F)	psi	2,901	
Shore D-hardness		79	DIN 53505

Physical and Thermal Properties

Max. long-term application temperature	°F	176	
Max. application temperature, short-term	°F	338	
Min. application temperature	°F	-40	
Thermal conductivity	W/m x K	0.24	ASTM C 177
Coefficient of thermal expansion	K ⁻¹ x 10 ⁻⁵	10	DIN 53752

Electrical Properties

Specific volume resistance	Ωcm	> 10 ¹³	DIN IEC 93
Surface resistance	Ω	> 10 ¹¹	DIN 53482



Picture 18.2: A wide range of Clip bearings are available in both inch and metric sizes



Compressive Strength

The permissible static load of iglide Clip bearings at room temperature is 2610 psi. Due to the possibility of high tolerances in the housing bore, the clip bearing has a high compressive strength even for punched holes. For bearing surfaces that are very small, the vibration-dampening properties and the resistance to edge loads are especially important.

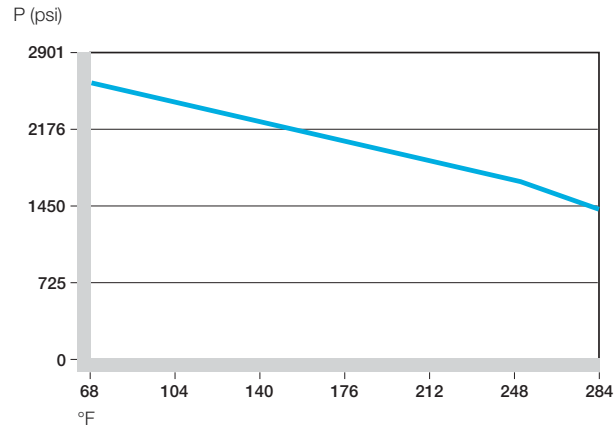

Graph 18.1: Permissible static surface pressure as a result of the operating temperature for clip bearings made of iglide® M250

Surface Speeds

Clip bearings are extremely wear-resistant in slow rotating, oscillating, and axial movements. The maximum surface speeds for the different movements are the same as for the iglide® M250 material (See adjacent table).

With lubrication during installation or continuous lubrication, the permissible speeds can be increased.

	Continuous fpm	Short Term fpm
Rotating	157	393
Oscillating	118	275
Linear	492	984

Table 18.1: Maximum running speeds

Operating Temperatures

For operating temperatures up to 176°F, iglide® clip bearings display high wear resistance.

Even in the cold, the plain bearings remain elastic and wear-resistant.

iglide® M250	Application Temperature
Minimum	- 40°F
Max. Long-term	+ 176°F
Max. Short-term	+ 338°F

Table 18.2: Temperature limits for iglide® M250

Installation

For installation, the plain bearings are pressed together on the side with the large flange. The angled slit makes the bearing spiral -shaped so that it can be placed easily into the metal plate.

The slit also compensates for expansions of the circumference. In this way, a tight clearance is possible with the clip bearings. The recommended clearance allows a nominal size shaft to turn easily. The Clip bearing can also rotate within the housing bore.



iglide® Clip

PDF: www.igus.com/iglide-pdfs
CAD: www.igus.com/iglide-CAD
RoHS info: www.igus.com/RoHS

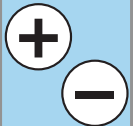



iglide® Plain Bearings Clip - Inch

iglide® Clip - Inch

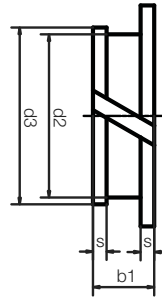
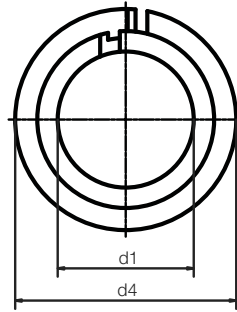

Telephone 1-800-521-2747
Fax 1-401-438-7270

Part Number	d1	d2	d3	d4	s	b1	ID of Bearing in Housing	Recommended Sheet Metal Thickness
MCI-03-01	3/16	0.2343	1/4	5/16	0.032	0.1380	.1885	.040/.075
MCI-03-02	3/16	0.2343	1/4	5/16	0.032	0.2000	.1885	.072/.135
MCI-04-01	1/4	0.3125	11/32	7/16	0.032	0.1380	.2510	.040/.075
MCI-04-02	1/4	0.3125	11/32	7/16	0.032	0.2000	.2510	.072/.135
MCI-05-01	5/16	0.3750	13/32	1/2	0.032	0.1380	.3135	.040/.075
MCI-05-02	5/16	0.3750	13/32	1/2	0.032	0.2000	.3135	.072/.135
MCI-06-01	3/8	0.4375	15/32	9/16	0.032	0.1380	.3760	.040/.075
MCI-06-02	3/8	0.4375	15/32	9/16	0.032	0.2000	.3760	.072/.135
MCI-07-01	7/16	0.5000	17/32	5/8	0.032	0.1380	.4385	.040/.075
MCI-07-02	7/16	0.5000	17/32	5/8	0.032	0.2000	.4385	.072/.135
MCI-08-01	1/2	0.5625	19/32	11/16	0.032	0.1380	.5010	.040/.075
MCI-08-02	1/2	0.5625	19/32	11/16	0.032	0.2000	.5010	.072/.135
MCI-10-01	5/8	0.6875	23/32	7/8	0.032	0.1380	.6260	.040/.075
MCI-10-02	5/8	0.6875	23/32	7/8	0.032	0.2000	.6260	.072/.135
MCI-12-01	3/4	0.8125	27/32	1	0.032	0.1380	.7510	.040/.075
MCI-12-02	3/4	0.8125	27/32	1	0.032	0.2000	.7510	.072/.135

Part Number	Recommended Housing Bore		Recommended Shaft Size	
	Max.	Min.	Max.	Min.
MCI-03-01	0.2414	0.2343	0.1875	0.1865
MCI-03-02	0.2414	0.2343	0.1875	0.1865
MCI-04-01	0.3212	0.3125	0.2500	0.2490
MCI-04-02	0.3212	0.3125	0.2500	0.2490
MCI-05-01	0.3834	0.3750	0.3125	0.3115
MCI-05-02	0.3834	0.3750	0.3125	0.3115
MCI-06-01	0.4481	0.4375	0.3750	0.3740
MCI-06-02	0.4481	0.4375	0.3750	0.3740
MCI-07-01	0.5106	0.5000	0.4375	0.4365
MCI-07-02	0.5106	0.5000	0.4375	0.4365
MCI-08-01	0.5731	0.5625	0.5000	0.4990
MCI-08-02	0.5731	0.5625	0.5000	0.4990
MCI-10-01	0.6981	0.6875	0.6250	0.6240
MCI-10-02	0.6981	0.6875	0.6250	0.6240
MCI-12-01	0.8255	0.8125	0.7500	0.7490
MCI-12-02	0.8255	0.8125	0.7500	0.7490

Internet: <http://www.igus.com>
email: sales@igus.com
QuickSpec: <http://www.igus.com/iglide-quickspec>

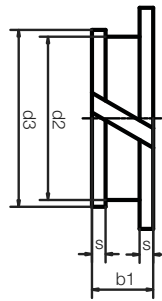
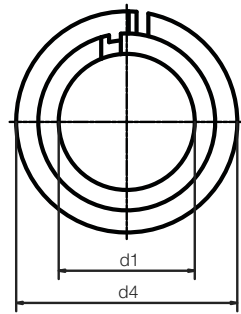

iglide® Clip - MM

Part Number	d1	d2	d3	d4	s	b1	ID of Bearing in Housing	Recommended Sheet Metal Thickness
MCM-03-02	3	4.2	4.8	6	0.6	3.2	3.025	2.34/1.45
MCM-03-03	3	4.2	4.8	6	0.6	4.2	3.025	3.13/2.87
MCM-04-02	4	5.2	5.9	7	0.6	3.2	4.025	2.34/1.45
MCM-04-03	4	5.2	5.9	7	0.6	4.2	4.025	3.13/2.87
MCM-05-02	5	6.2	6.8	8	0.6	3.2	5.025	2.34/1.45
MCM-05-03	5	6.2	6.8	8	0.6	4.2	5.025	3.13/2.87
MCM-06-02	6	7.2	7.8	11	0.6	3.2	6.025	2.34/1.45
MCM-06-03	6	7.2	7.8	11	0.6	4.2	6.025	3.13/2.87
MCM-06-04	6	7.2	7.8	11	0.6	5.2	6.025	4.40/4.00
MCM-07-03	7	9	9.8	13	0.8	4.6	7.025	3.13/2.87
MCM-08-02	8	9.6	10.4	13	0.8	3.6	8.025	2.34/1.45
MCM-08-03	8	9.6	10.4	13	0.8	4.6	8.025	3.13/2.87
MCM-09-02	9	10.6	11.4	14	0.8	3.6	9.025	2.34/1.45
MCM-10-02	10	11.6	12.4	15	0.8	3.6	10.025	2.34/1.45
MCM-10-03	10	11.6	12.4	15	0.8	4.6	10.025	3.13/2.87
MCM-12-02	12	13.6	14.4	17	0.8	3.6	12.025	2.34/1.45
MCM-12-03	12	13.6	14.4	17	0.8	4.6	12.025	3.13/2.87
MCM-12-04	12	13.6	14.4	17	0.8	5.6	12.025	4.40/4.00
MCM-14-03	14	15.6	16.4	19	0.8	4.6	14.025	3.13/2.87
MCM-16-02	16	17.6	18.4	21	0.8	3.6	16.025	2.34/1.45
MCM-16-03	16	17.6	18.4	21	0.8	4.6	16.025	3.13/2.87
MCM-18-03	18	20	21	23	1.0	5.0	18.025	3.13/2.87
MCM-20-03	20	22	23	25	1.0	5.0	20.025	3.13/2.87
MCM-25-03	25	27	28	30	1.0	5.0	25.025	3.13/2.87

For recommended housing bore and shaft sizes see the following page

PDF: www.igus.com/iglide-pdfs
 CAD: www.igus.com/iglide-CAD
 RoHS info: www.igus.com/RoHS

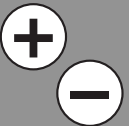



iglide® Clip - MM

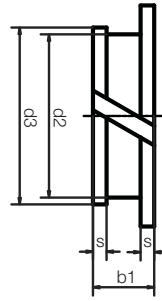
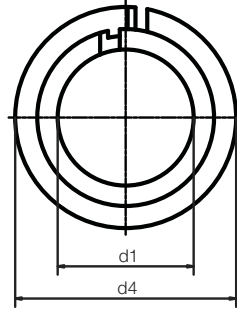

Telephone 1-800-521-2747
Fax 1-401-438-7270

Part Number	Recommended Housing Bore		Recommended Shaft Size	
	Max.	Min.	Max.	Min.
MCM-03-02	4.380	4.200	3.000	2.975
MCM-03-03	4.380	4.200	3.000	2.975
MCM-04-02	5.380	5.200	4.000	3.975
MCM-04-03	5.380	5.200	4.000	3.975
MCM-05-02	6.420	6.200	5.000	4.975
MCM-05-03	6.420	6.200	5.000	4.975
MCM-06-02	7.420	7.200	6.000	5.975
MCM-06-03	7.420	7.200	6.000	5.975
MCM-06-04	7.420	7.200	6.000	5.975
MCM-07-03	9.220	9.000	7.000	6.975
MCM-08-02	9.820	9.600	8.000	7.975
MCM-08-03	9.820	9.600	8.000	7.975
MCM-09-02	10.870	10.600	9.000	8.975
MCM-10-02	11.870	11.600	10.000	9.975
MCM-10-03	11.870	11.600	10.000	9.975
MCM-12-02	13.870	13.600	12.000	11.975
MCM-12-03	13.870	13.600	12.000	11.975
MCM-12-04	13.870	13.600	12.000	11.975
MCM-14-03	15.870	15.600	14.000	13.975
MCM-16-02	17.870	17.600	16.000	15.975
MCM-16-03	17.870	17.600	16.000	15.975
MCM-18-03	20.330	20.000	18.000	17.975
MCM-20-03	22.330	22.000	20.000	19.975
MCM-25-03	27.330	27.000	25.000	24.975

Internet: <http://www.igus.com>
email: sales@igus.com
QuickSpec: <http://www.igus.com/iglide-quickspec>

igus[®]



iglide[®] Clip2



Product Range

- Inner diameters:
Inch sizes from 3/16 - 1 in.
Metric sizes from 4 - 25 mm

Part Number Structure

Part Number Structure

M Y I - 03 - 03

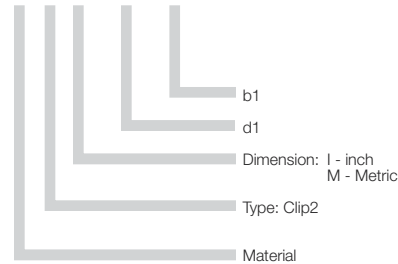

Permissible Surface Speeds

	Continuous fpm	Short Term fpm
Rotating	157	393
Oscillating	118	275
Linear	492	984

Special Properties



- Split version of the iglide® M250 bearing
- Easy assembly by hand
- Compensation for heat expansion
- Suitable for ambient temperatures with high humidity
- Lightweight
- Very economical
- Inch and metric sizes available from stock

The iglide® Clip2 bearing is a thin walled bearing in the iglide® M250 material with beveled edge for extremely simple installations. The diagonal slit helps to compensate for poor housing bore tolerance as well as temperature and humidity changes. These self lubricating plain bearings are defined by their impact strength, vibration dampening, and wear resistant properties. They excel in applications in which vibration dampening is necessary, for example, in fitness and packaging machines.

Material Table

General Properties	Unit	iglide® M250	Testing Method
Density	g/cm ³	1.14	
Color		charcoal	
Max. moisture absorption at 73°F / 50% r.h.	% weight	1.4	DIN 53495
Max. moisture absorption	% weight	7.6	
Coefficient of friction, dynamic against steel	μ	0.1 - 0.3	
p x v value, max. (dry)	psi x fpm	3,400	

Mechanical Properties

Modulus of elasticity	psi	391,600	DIN 53457
Tensile strength at 68°F	psi	16,240	DIN 53452
Compressive strength	psi	7,540	
Permissible static surface pressure (68°F)	psi	2,901	
Shore D-hardness		79	DIN 53505

Physical and Thermal Properties

Max. long-term application temperature	°F	176	
Max. application temperature, short-term	°F	338	
Min. application temperature	°F	-40	
Thermal conductivity	W/m x K	0.24	ASTM C 177
Coefficient of thermal expansion	K ⁻¹ x 10 ⁻⁵	10	DIN 53752

Electrical Properties

Specific volume resistance	Ωcm	> 10 ¹³	DIN IEC 93
Surface resistance	Ω	> 10 ¹¹	DIN 53482



Visit www.igus.com
to use our online
expert system



Compressive Strength

The permissible static load of iglide Clip bearings at room temperature is 2610 psi. Due to the possibility of high tolerances in the housing bore, the clip bearing has a high compressive strength even for punched holes. For bearing surfaces that are very small, the vibration-dampening properties and the resistance to edge loads are especially important.

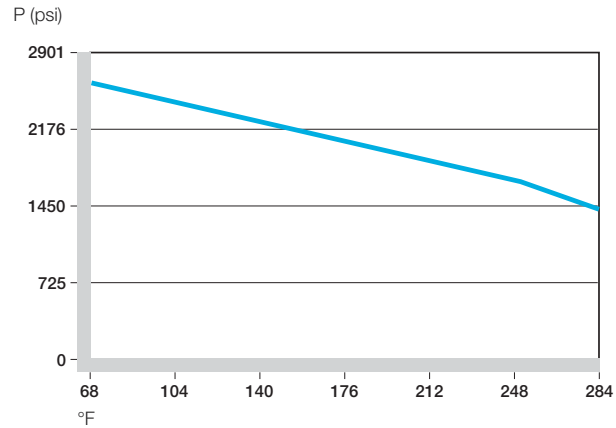

Graph 19.1: Permissible static surface pressure as a result of the operating temperature for clip bearings made of iglide® M250

Surface Speeds

Clip bearings are extremely wear-resistant in slow rotating, oscillating, and axial movements. The maximum surface speeds for the different movements are the same as for the iglide® M250 material (See adjacent table).

With lubrication during installation or continuous lubrication, the permissible speeds can be increased.

	Continuous fpm	Short Term fpm
Rotating	157	393
Oscillating	118	275
Linear	492	984

Table 19.1: Maximum running speeds

Operating Temperatures

For operating temperatures up to 176°F, iglide® clip bearings display high wear resistance.

Even in the cold, the plain bearings remain elastic and wear-resistant.

iglide® M250	Application Temperature
Minimum	- 40°F
Max. Long-term	+ 176°F
Max. Short-term	+ 338°F

Table 19.2: Temperature limits for iglide® M250

Installation

For installation, the plain bearings are pressed together on the side with the large flange. The angled slit makes the bearing spiral -shaped so that it can be placed easily into the metal plate.

The slit also compensates for expansions of the circumference. In this way, a tight clearance is possible with the clip bearings. The recommended clearance allows a nominal size shaft to turn easily. The Clip bearing can also rotate within the housing bore.

iglide® Clip2

PDF: www.igus.com/iglide-pdfs
CAD: www.igus.com/iglide-CAD
RoHS info: www.igus.com/RoHS

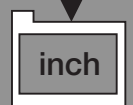
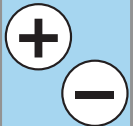



iglide® Clip2 - Inch

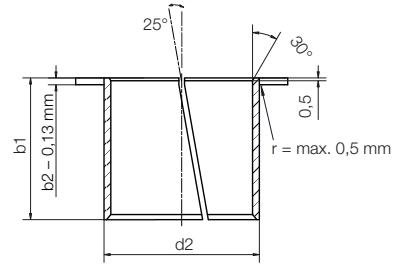
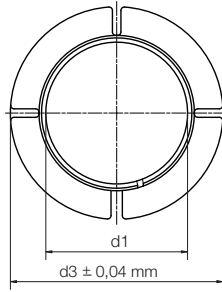

Telephone 1-800-521-2747
Fax 1-401-438-7270

Part Number	d1	d2	d3	b1	b2	W	a1=a2	Recommended Housing Bore		Recommended Shaft Size	
								Max.	Min.	Max.	Min.
MYI-03-03	3/16	0.2339	5/16	3/16	0.0252	25°	0.0394	0.2351	0.2339	0.1875	0.1865
MYI-04-04	1/4	0.2965	13/32	1/4	0.0252	25°	0.0394	0.2979	0.2965	0.2500	0.2490
MYI-05-05	5/16	0.3744	1/2	5/16	0.0299	25°	0.0394	0.3758	0.3744	0.3125	0.3115
MYI-06-06	3/8	0.4370	19/32	3/8	0.0299	25°	0.0394	0.4387	0.4370	0.3750	0.3740
MYI-07-07	7/16	0.4996	21/32	7/16	0.0299	25°	0.0394	0.5013	0.4996	0.4375	0.4365
MYI-08-06	1/2	0.5618	3/4	3/8	0.0299	25°	0.0591	0.5635	0.5618	0.5000	0.4990
MYI-08-08	1/2	0.5618	3/4	1/2	0.0299	25°	0.0591	0.5635	0.5618	0.5000	0.4990
MYI-10-07	5/8	0.6870	15/16	7/16	0.0299	25°	0.0591	0.6887	0.6870	0.6250	0.6240
MYI-10-10	5/8	0.6870	15/16	5/8	0.0299	25°	0.0591	0.6887	0.6870	0.6250	0.6240
MYI-10-18	5/8	0.6870	15/16	1 1/8	0.0299	25°	0.0591	0.6887	0.6870	0.6250	0.6240
MYI-12-12	3/4	0.8118	1 1/8	3/4	0.0299	25°	0.0591	0.8139	0.8118	0.7500	0.7490
MYI-12-18	3/4	0.8118	1 1/8	1 1/8	0.0299	25°	0.0591	0.8139	0.8118	0.7500	0.7490
MYI-14-7.5	7/8	0.9370	1 5/16	15/32	0.0299	25°	0.0591	0.9391	0.9370	0.8750	0.8740
MYI-14-14	7/8	0.9370	1 5/16	7/8	0.0299	25°	0.0591	0.9391	0.9370	0.8750	0.8740
MYI-16-10	1	1.0933	1 1/2	5/8	0.0449	25°	0.0591	1.0954	1.0933	1.0000	0.9985
MYI-16-14	1	1.0933	1 1/2	7/8	0.0449	25°	0.0591	1.0954	1.0933	1.0000	0.9985
MYI-16-16	1	1.0933	1 1/2	1	0.0499	25°	0.0591	1.0954	1.0933	1.0000	0.9985

Internet: <http://www.igus.com>
email: sales@igus.com
QuickSpec: <http://www.igus.com/iglide-quickspec>

iglide® Plain Bearings Clip2 - MM

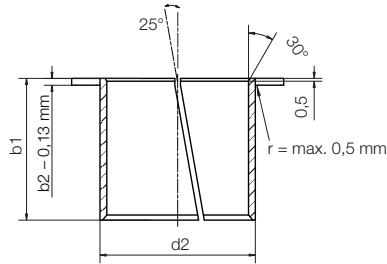
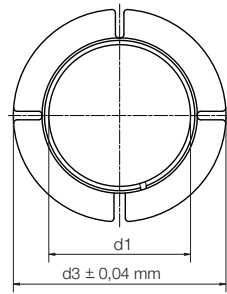

iglide® Clip2 - MM

Part Number	d1	d2	d3	b1	b2	W	a1=a2	Recommended Housing Bore		Recommended Shaft Size	
								Max.	Min.	Max.	Min.
MYM-04-04	4	5.2	7.0	4.0	0.6	25°	1.000	5.230	5.200	4.000	3.975
MYM-05-05	5	6.2	8.0	5.0	0.6	25°	1.000	6.236	6.200	5.000	4.975
MYM-06-06	6	7.2	9.5	6.0	0.6	25°	1.000	7.236	7.200	6.000	5.975
MYM-08-08	8	9.6	12.0	8.0	0.8	25°	1.000	9.636	9.600	8.000	7.975
MYM-10-10	10	11.6	15.0	10.0	0.8	25°	1.000	11.643	11.600	10.000	9.975
MYM-12-06	12	13.6	18.0	6.0	0.8	25°	1.000	13.643	13.600	12.000	11.975
MYM-12-12	12	13.6	18.0	12.0	0.8	25°	1.000	13.643	13.600	12.000	11.975
MYM-14-14	14	15.6	21.0	14.0	0.8	25°	1.000	15.643	15.600	14.000	13.975
MYM-16-16	16	17.6	24.0	16.0	0.8	25°	1.000	17.643	17.600	16.000	15.975
MYM-20-20	20	21.6	30.0	20.0	0.8	25°	1.000	21.652	21.600	20.000	19.975
MYM-25-25	25	27.4	37.5	25.0	1.2	25°	1.000	27.452	27.400	25.000	24.962

PDF: www.igus.com/iglide-pdfs
 CAD: www.igus.com/iglide-CAD
 RoHS info: www.igus.com/RoHS

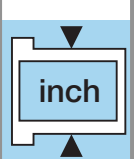



iglide® Plain Bearings
Clip2 - Notes

iglide® Clip2

Telephone 1-800-521-2747
Fax 1-401-438-7270

Internet: <http://www.igus.com>
email: sales@igus.com
QuickSpec: <http://www.igus.com/iglide-quickspec>

igus[®]



iglide[®]

Pre-tensioned



Product Range

- Standard Styles:
Sleeve, Flange
- Inner diameters:
Inch sizes from 3/8 - 1 in.
Metric sizes from 8 - 20 mm

Part Number Structure

Part Number Structure

J V S I - 06 08 - 06

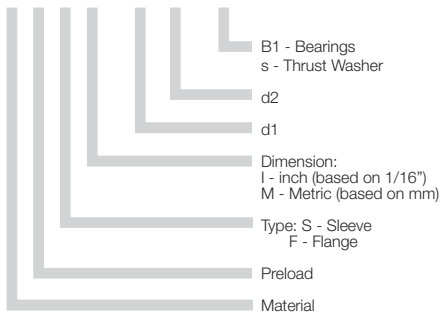

Permissible Surface Speeds

	Continuous fpm	Short Term fpm
Rotating	295	590
Oscillating	216	413
Linear	1574	1969

Advantages



- Clearance-free preloaded bearing even without load
- Made from iglide® J

iglide® pre-tensioned bearings are free from clearance in unloaded state because of the pretension at the ends. The material iglide® J is designed for the lowest coefficient of friction while running dry for its low stick slip tendency.

Material Table

General Properties	Unit	iglide® J	Testing Method
Density	g/cm ³	1.49	
Color		yellow	
Max. moisture absorption at 73°F/50% r.h.	% weight	0.3	DIN 53495
Max. moisture absorption	% weight	1.3	
Coefficient of friction, dynamic against steel	μ	0.06 - 0.18	
p x v value, max. (dry)	psi x fpm	9700	

Mechanical Properties

Modulus of elasticity	psi	348,000	DIN 53457
Tensile strength at 68°F	psi	10,585	DIN 53452
Compressive strength	psi	8,700	
Permissible static surface pressure (68°F)	psi	5,075	
Shore D-hardness		74	DIN 53505

Physical and Thermal Properties

Max. long-term application temperature	°F	194	
Max. application temperature, short-term	°F	248	
Min. application temperature	°F	-58	
Thermal conductivity	W/m x K	0.25	ASTM C 177
Coefficient of thermal expansion (at 73°F)	K ⁻¹ x 10 ⁻⁵	10	DIN 53752

Electrical Properties

Specific volume resistance	Ωcm	> 10 ¹³	DIN IEC 93
Surface resistance	Ω	> 10 ¹²	DIN 53482



Visit www.igus.com
to use our online
expert system



Compressive Strength

With a maximum permissible surface pressure of 5075 psi, iglide® J material is not suited for extreme loads. Shown in Graph 20.2 is the elastic deformation of iglide® J for radial loads. At the maximum permissible load of 5075 psi, the deformation is less than 2.5%.

► Compressive Strength, Page 1.3

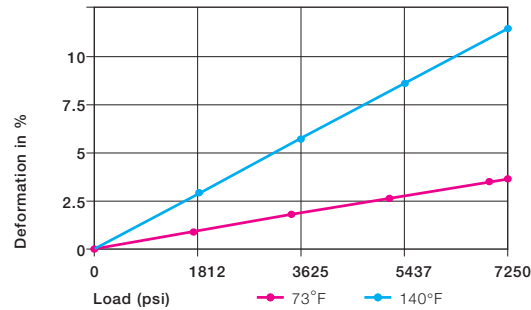

Graph 20.2: Deformation under load and temperature

Permissible Surface Speeds

The low coefficient of friction and the extremely low stick-slip tendency of iglide® JV bearings are especially important at very low speeds. However, iglide® J material can also be used for high speeds of over 197 fpm. In both cases, the static friction is very low and stick-slip does not occur.

The maximum values given in Table 20.2 can only be achieved at the lowest pressure loads. At the given speeds, friction can cause a temperature increase to maximum permissible levels. In practice, though, this temperature level is rarely reached, due to varying application conditions.

- Surface Speed, Page 1.5
- $p \times v$ value, Page 1.6

	Continuous fpm	Short Term fpm
Rotating	295	590
Oscillating	216	413
Linear	1574	1969

Table 20.2: Maximum surface speeds

Temperatures

iglide® J material can be used between -58°F and 194°F; the short-term maximum permissible temperature is 248°F. Graph 18.3 shows that the compressive strength of iglide® J material decreases with increasing temperatures. Also, the wear increases significantly above 176°F

► Application Temperatures, Page 1.7

iglide® J	Application Temperature
Minimum	-58 °F
Max., long-term	+194 °F
Max., short-term	+248 °F

Table 20.3: Temperature limits for iglide® J

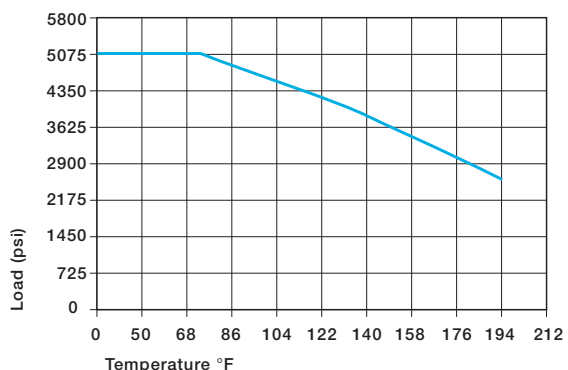

Graph 20.3: Recommended maximum permissible static surface pressure of iglide® J as a result of the temperature

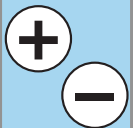



iglide® JV
Sleeve, Flange - Inch

Telephone 1-800-521-2747
1-401-438-7270
Fax

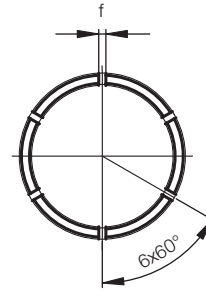
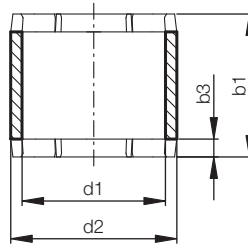

Dimensions (inch)

Part Number	d1	d2	b	b3	d1 Tolerance		Recommended Housing	
					Max.	Min.	Max.	Min.
JVSI-0608-06	3/8	1/2	3/8	0.079	0.3773	0.3750	0.5007	0.5000
JVSI-0810-08	1/2	5/8	1/2	0.079	0.5040	0.5013	0.6257	0.6250
JVSI-1012-10	5/8	3/4	5/8	0.098	0.6297	0.6270	0.7508	0.7500
JVSI-1214-12	3/4	7/8	3/4	0.098	0.7541	0.7505	0.8758	0.8750
JVSI-1618-16	1	1 1/8	1	0.098	1.0041	1.0007	1.1258	1.1250

iglide® Plain Bearings
JV - Flange, Inch

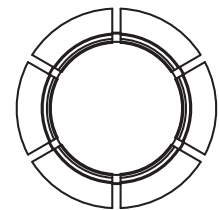
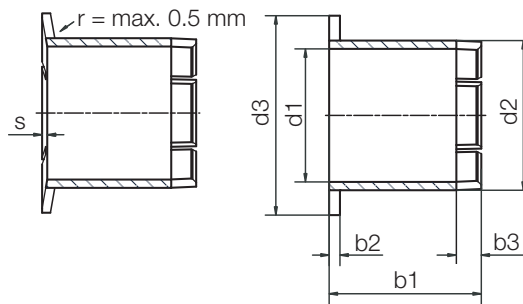

Dimensions (inch)

Part Number	d1	d2	d3	b1	b2	b3	d1 Tolerance		Recommended Housing	
							Max.	Min.	Max.	Min.
JVFI-0608-06	3/8	1/2	0.625	3/8	0.062	0.079	0.3773	0.3750	0.5007	0.5000
JVFI-0810-08	1/2	5/8	0.875	1/2	0.062	0.079	0.5040	0.5013	0.6257	0.6250
JVFI-1012-10	5/8	3/4	1.000	5/8	0.062	0.098	0.6297	0.6270	0.7508	0.7500
JVFI-1214-12	3/4	7/8	1.125	3/4	0.062	0.098	0.7541	0.7505	0.8758	0.8750
JVFI-1618-16	1	1 1/8	1.375	1	0.062	0.098	1.0041	1.0007	1.1258	1.1250

Internet: <http://www.igus.com>
email: sales@igus.com
QuickSpec: <http://www.igus.com/iglide-quickspec>

iglide® Plain Bearings JV - Sleeve, MM

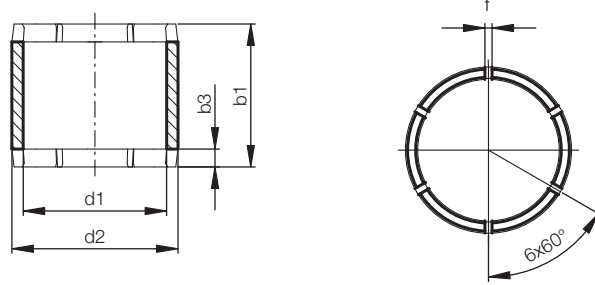

Dimensions (mm)

Part No.	d1	d2	b1	b3 h13	f	d1-Tolerance (E10)		Recommended Housing	
						Max.	Min.	Max.	Min.
JVSM-0810-08	8	10	8	2.0	1	8.083	8.025	10.015	10.000
JVSM-1012-10	10	12	10	2.0	1	10.083	10.025	12.018	12.000
JVSM-1214-12	12	14	12	2.0	1	12.102	12.032	14.018	14.000
JVSM-1416-14	14	16	14	2.0	1	14.102	14.032	16.018	16.000
JVSM-1517-15	15	17	15	2.5	1	15.102	15.032	17.018	17.000
JVSM-1820-18	18	20	18	2.5	1	18.102	18.032	20.021	20.000
JVSM-2023-20	20	23	20	2.5	1	20.140	20.040	23.021	23.000

iglide® Plain Bearings JV - Flange, MM

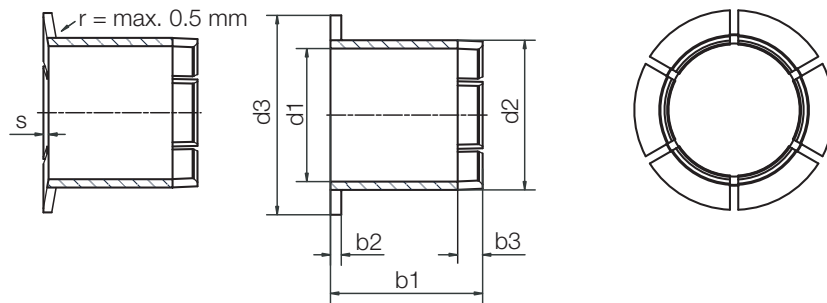

Dimensions (mm)

Part No.	d1	d2	d3	b1 h13	b2	b3	s	d1-Tolerance (E10)		Recommended Housing	
								Max.	Min.	Max.	Min.
JVFM-0810-10	8	10	15	10	1	2.0	0.44	8.083	8.025	10.015	10.000
JVFM-1012-10	10	12	18	10	1	2.0	0.53	10.083	10.025	12.018	12.000
JVFM-1214-12	12	14	20	12	1	2.0	0.53	12.102	12.032	14.018	14.000
JVFM-1416-12	14	16	22	12	1	2.0	0.53	14.102	14.032	16.018	16.000
JVFM-1517-15	15	17	23	15	1	2.5	0.53	15.102	15.032	17.018	17.000
JVFM-1820-18	18	20	26	18	1	2.5	0.53	18.102	18.032	20.021	20.000
JVFM-2023-20	20	23	30	20	1.5	2.5	0.62	20.140	20.040	23.021	23.000

PDF: www.igus.com/iglide-pdfs
 CAD: www.igus.com/iglide-CAD
 RoHS info: www.igus.com/RoHS





iglide® Plain Bearings
JV - Notes

iglide® JV

Telephone 1-800-521-2747
Fax 1-401-438-7270

Internet: <http://www.igus.com>
email: sales@igus.com
QuickSpec: <http://www.igus.com/iglide-quickspec>

igus[®]



iglide[®]
Piston Rings



iglide® Plain Bearings Piston Rings - Technical Data

Product Range

- Standard Styles:
Metric sizes from 10 - 70 mm

Other material Options

iglide® J: universal
(standard piston ring material)
iglide® A180: FDA conform
iglide® J4: cost-effective
iglide® J350: temperature requirements
up to +194 °F
iglide® T500: chemicals, temperatures
Choose your material and diameter from
the iglus® bearing

Part Number Structure

Part Number Structure

J PR M - 10 12 - 054

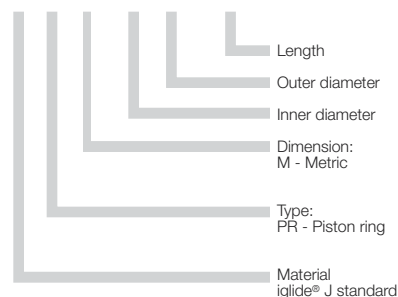

Advantages

- Easy installation
- Economic
- More wear resistant than PTFE strips
- High load capacity
- Wide dimensional range
- Available in a wide range of materials

Usage Guidelines



- When piston rings with excellent wear properties are required
- When simple assembly is important
- When high edge loads occur
- When tailor-made solutions based on iglide® materials are required



- When piston rings should also act as a seal
- When different diameters should be covered by one part

Why complicate things when it can be done simply? Replace complex PTFE tapes with a single clip-on guide ring, for example in cylinders, control valves and fittings. We offer iglide® piston rings made of any iglide® material for a wide range of applications.

Standard method

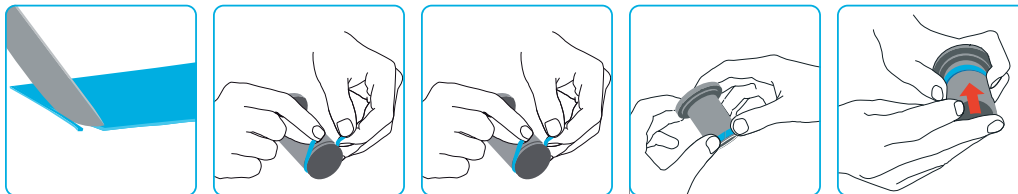

Piston ring method

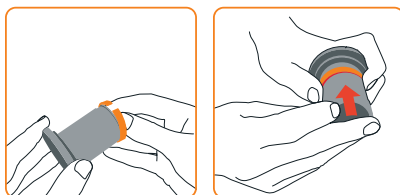

Material Table

General Properties	Unit	iglide® J	Testing Method
Density	g/cm ³	1.49	
Color		yellow	
Max. moisture absorption at 73°F/50% r.h.	% weight	0.3	DIN 53495
Max. moisture absorption	% weight	1.3	
Coefficient of friction, dynamic against steel	μ	0.06 - 0.18	
p x v value, max. (dry)	psi x fpm	9700	

Mechanical Properties

Modulus of elasticity	psi	348,000	DIN 53457
Tensile strength at 68°F	psi	10,585	DIN 53452
Compressive strength	psi	8,700	
Permissible static surface pressure (68°F)	psi	5,075	
Shore D-hardness		74	DIN 53505

Physical and Thermal Properties

Max. long-term application temperature	°F	194	
Max. application temperature, short-term	°F	248	
Min. application temperature	°F	-58	
Thermal conductivity	W/m x K	0.25	ASTM C 177
Coefficient of thermal expansion (at 73°F)	K ⁻¹ x 10 ⁻⁵	10	DIN 53752

Electrical Properties

Specific volume resistance	Ωcm	> 10 ¹³	DIN IEC 93
Surface resistance	Ω	> 10 ¹²	DIN 53482

iglide® Plain Bearings Piston Rings - Technical Data



iglide® Piston Rings

Part Number	Inner diameter d1	Outer diameter d2	Piston ring Width b1; (h13)	Gap width	Gap Tolerance ± mm	Split angle (°)
JPRM-1012-054	10	12	5.4	2.5	0.5	20
JPRM-1214-054	12	14	5.4	2.5	0.5	20
JPRM-1416-054	14	16	5.4	2.5	0.5	20
JPRM-1618-054	16	18	5.4	2.5	0.5	20
JPRM-2023-054	20	23	5.4	2.5	0.5	20
JPRM-2528-054	25	28	5.4	2.5	0.5	20
JPRM-3034-054	30	34	5.4	2.5	0.5	20
JPRM-3539-054	35	39	5.4	2.5	0.5	20
JPRM-4044-054	40	44	5.4	2.5	0.5	20
JPRM-4550-054	44	50	5.4	2.5	0.5	20
JPRM-5055-054	50	55	5.4	2.5	0.5	20
JPRM-6065-054	60	65	5.4	2.5	0.5	20
JPRM-7075-054	70	75	5.4	2.5	0.5	20

PDF: www.igus.com/iglide-pdfs
 CAD: www.igus.com/iglide-CAD
 RoHS info: www.igus.com/RoHS

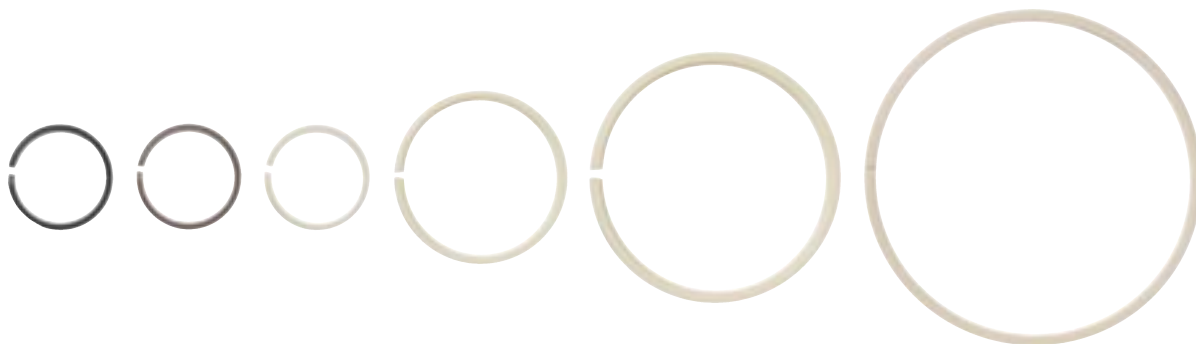
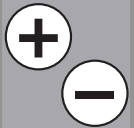



iglide® Plain Bearings
Type - Notes

iglide® Type

Telephone 1-800-521-2747
Fax 1-401-438-7270

Internet: <http://www.igus.com>
email: sales@igus.com
QuickSpec: <http://www.igus.com/iglide-quickspec>

igus[®]

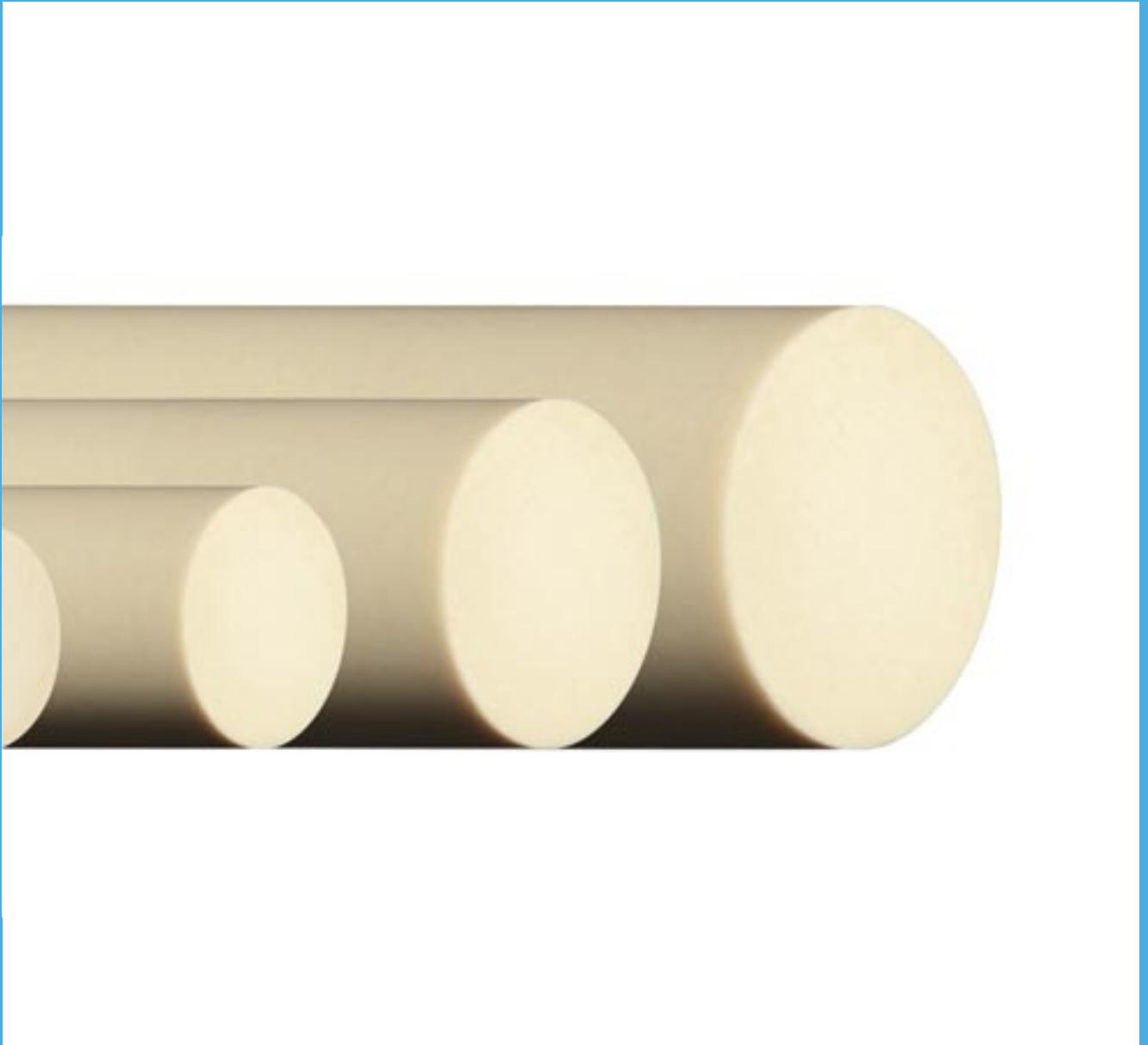

iglide[®] Bar Stock



iglide® Bearings Bar Stock - Technical Data

Product Range

- Available in 6 materials
 - iglide® J
 - iglide® A180
 - iglide® L280
 - iglide® P210
 - iglide® J4
 - iglide® R
- Available in Outer Diameters from 10mm to 100mm depending on materials selection

Part Number Structure

Part Number Structure

S J - 30 - 500

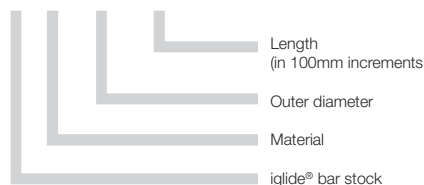

iglide® barstock is available in various outside diameters and is a solid piece making it ideal for machining custom shapes. Barstock is made using iglide® proven thermoplastic blends. Length's available from 100 mm to 1000 mm in 100 mm increments.



Material Table iglide® J, A180 and L280

General Properties	Unit	iglide® J	iglide® A180
Color		yellow	white
Max. moisture absorption at 73°F/50% r.h.	% weight	0.3	0.2
Max. moisture absorption	% weight	1.3	1.3
Mechanical Properties			
Modulus of elasticity	psi	348,000	333,585
Tensile strength at 68°F	psi	10,585	12,765
Permissible static surface pressure (68°F)	psi	5,075	4,050
Shore D-hardness		74	76
Physical and Thermal Properties			
Max. long-term application temperature	°F	194	194
Max. short-term application temperature	°F	248	230
Min. application temperature	°F	-58	-58

Advantages



- Machining samples for testing prior to ordering a new tool
- For applications where machining tolerances must be held
- For smaller orders that do not warrant a new tool

Material Table iglide® J4, R and P210

General Properties	Unit	iglide® J4	iglide® R	iglide® P210
Color		gray	red	yellow
Max. moisture absorption at 73°F/50% r.h.	% weight	0.3	0.2	0.3
Max. moisture absorption	% weight	1.3	1.1	0.5
Mechanical Properties				
Modulus of elasticity	psi	340,750	290,000	319,083
Tensile strength at 68°F	psi	10,150	10,150	9,425
Permissible static surface pressure (68°F)	psi	5,075	3,335	7,250
Shore D-hardness		74	77	75
Physical and Thermal Properties				
Max. long-term application temperature	°F	194	194	212
Max. short-term application temperature	°F	248	230	320
Min. application temperature	°F	-58	-58	-40



- iglide® materials as round material from stock
- Special components and special sizes available in shortened delivery times
- Fast and cost-effective
- Predictable service life for plain bearing applications based on real-life test data

iglide® Bar Stock

Dimensions (mm)

Part No.	Size	Material
SJ-10-XXX	10	iglide® J
SJ-20-XXX	20	iglide® J
SJ-30-XXX	30	iglide® J
SJ-40-XXX	40	iglide® J
SJ-50-XXX	50	iglide® J
SJ-60-XXX	60	iglide® J
SJ-80-XXX	80	iglide® J
SJ-100-XXX	100	iglide® J

Part No.	Size	Material
SJ4-30-XXX	30	iglide® J4

Part No.	Size	Material
SR-30-XXX	30	iglide® R

Part No.	Size	Material
SP210-30-XXX	30	iglide® P210

Part No.	Size	Material
SA180-10-XXX	10	iglide® A180
SA180-20-XXX	20	iglide® A180
SA180-30-XXX	30	iglide® A180
SA180-40-XXX	40	iglide® A180
SA180-50-XXX	50	iglide® A180
SA180-60-XXX	60	iglide® A180
SA180-80-XXX	80	iglide® A180
SA180-100-XXX	100	iglide® A180

PDF: www.igus.com/iglide-pdfs
 CAD: www.igus.com/iglide-CAD
 RoHS info: www.igus.com/RoHS

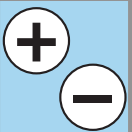



iglide® Bar Stock

Telephone 1-800-521-2747
Fax 1-401-438-7270

Internet: <http://www.igus.com>
email: sales@igus.com
QuickSpec: <http://www.igus.com/iglide-quickspec>

igus[®]



iglide[®] Flange

Product Range

- Available in 4 materials
Standard material: G300
- Inner diameters:
Metric sizes from 10 - 35 mm

Other material Options

- iglide® G300: standard
- iglide® A180: FDA conform
- iglide® J: universal
- iglide® T500: chemicals, temperatures

Part Number Structure

Part Number Structure

G FL - 03

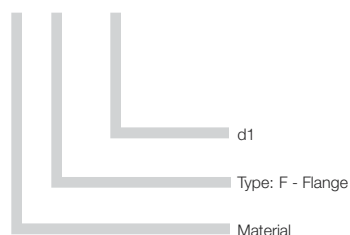

Advantages



- Maintenance-free
- Easy installation
- Very good wear resistance
- Very high temperature resistance
- Resistant to dirt, dust, and lint
- Corrosion-resistant
- Vibration-dampening
- Used for rotating and linear movements
- Very lightweight
- Can also be used in bore holes with larger tolerances



Visit www.igus.com
to use our online
expert system



With this design it is possible to use iglide® high performance plain bearings in locations where recommended housing bore tolerances are not possible.

Through the design, high loads are possible when there is a minimal precision requirement of the housing. iglide® maintenance-free flange bearings are made of iglide® G300, but can also be manufactured by special order from the different iglide® materials. In this way, all advantages of the iglide® high performance plastics can be utilized.

Material Data

General Properties	Unit	iglide® G300	iglide® A180	iglide® J	iglide® T500
Density	g/cm ³	1.45	1.46	1.49	1.44
Color		dark gray	white	yellow	black
Max. moisture absorption at 73°F / 50% r.h.	% weight	0.7	0.2	0.3	0.1
Max. moisture absorption	% weight	4.0	1.3	1.3	0.5
Coefficient of friction, dynamic against steel	μ	0.08-0.15	0.05-0.23	0.06-0.18	0.09-0.27
p x v-value, max. (dry)	psi x fpm	12,000	8,800	9700	37,700

Mechanical Properties

Modulus of elasticity	psi	1,131,000	333,585	348,000	1,174,500
Tensile strength at 68°F	psi	30,450	12,765	10,585	24,650
Compressive strength	psi	11,310	11,310	8,700	14,500
Max. static surface pressure (68°F)	psi	11,600	4,050	5,075	21,750
Shore D-hardness		81	76	74	85

Physical and Thermal Properties

Max. long-term application temperature	°F	266	194	194	482
Max. short-term application temperature	°F	428	230	248	599
Min. application temperature	°F	-40	-58	-58	-148
Thermal conductivity	(W/m x K)	0.24	0.25	0.25	0.6
Coefficient of thermal expansion (at 73°F)	(K ⁻¹ x 10 ⁻⁵)	9	11	10	5

Electrical Properties

Specific volume resistance	Ωcm	> 10 ¹³	> 10 ¹²	> 10 ¹³	> 10 ⁵
Surface resistance	Ω	> 10 ¹¹	> 10 ¹¹	> 10 ¹²	> 10 ³



Installation

Depending on the requirements, different mounting types can be considered. For low radial loads, it is sufficient to mount iglide® flange bearings on one surface simply with two bolts. For higher radial loads, it is recommended to support the iglide® flange bearing in a bore on the reinforced side facing the direction of the load. For this bore hole, large tolerances are permitted, since it only serves as additional support for the iglide flange bearing. In order to achieve higher radial loads in the bearings, the iglide® flange bearing can be pressfit into a recommended housing bore. The additional bolts ensure the fit of the bearing in the housing. For the installation of the iglide® maintenance-free flange bearing, no special materials or devices are necessary.



Picture 23.1: iglide® Flange Bearing



Picture 23.2: The installation of the iglide® flange bearing, simple and secure

Temperatures

Application temperatures affect the properties of plain bearings greatly. In the case of the standard iglide® G300 for the flange bearings, the short-term maximum temperature is 428°F, allowing for the use of iglide® G300 in heat treat applications when the bearing is not subjected to additional loading. In the extreme the iglide® T500 can see short-term temperatures of 599°F.

With increasing temperatures, the compressive strength of iglide® bearings decreases. However, at the maximum long-term temperature the compressive strength for each bearing material is still very high. See each material section located in the front of the catalog for more detailed temperature-wear and temperature-strength comparisons.

► Application Temperatures, 1.7

Temperature range for other materials

	Minimum	Max. Short-term	Max. Long-term
G300	-40°F	+128°F	+266°F
A180	-40°F	+230°F	+176°F
JFL	-58°F	+248°F	+194°F
TFL	-148°F	+599°F	+482°F

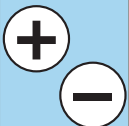



iglide® Flange

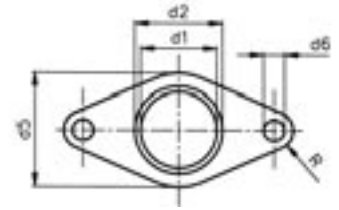
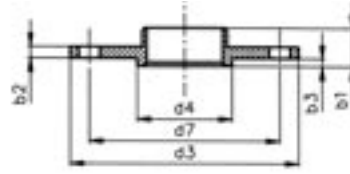

Dimensions (mm)

iglide® G300	d1 ¹⁾	d2 ²⁾	d3	d4	d5	d6	d7	b1	b2	b3	R
							(± 0,2)				
GFL-10	10	12	30	14	15	4,5	22	6	2	1	4
GFL-12	12	14	36	16	18	4,5	26	6	2	1	4,5
GFL-14	14	16	42	18	21	5,5	30	6	2	1	5
GFL-16	16	18	48	20	24	5,5	34	6	2	1	5,5
GFL-18	18	20	54	22	27	6,5	39	6	2	1	7
GFL-20	20	23	60	26	30	6,5	44	10	3	2	7
GFL-25	25	28	75	30	35	6,5	55	10	3	2	8,5
GFL-30	30	34	90	36	40	8,5	66	10	3	2	10
GFL-35	35	39	95	41	55	8,5	77	10	3	2	12

iglide® A180	d1 ¹⁾	d2 ²⁾	d3	d4	d5	d6	d7	b1	b2	b3	R
							(± 0,2)				
A180FL-10	10	12	30	14	15	4,5	22	6	2	1	4
A180FL-12	12	14	36	16	18	4,5	26	6	2	1	4,5
A180FL-16	16	18	48	20	24	5,5	34	6	2	1	5,5
A180FL-20	20	23	60	26	30	6,5	44	10	3	2	7
A180FL-25	25	28	75	30	35	6,5	55	10	3	2	8,5
A180FL-30	30	34	90	36	40	8,5	66	10	3	2	10
A180FL-35	35	39	95	41	55	8,5	77	10	3	2	12

iglide® J	d1 ¹⁾	d2 ²⁾	d3	d4	d5	d6	d7	b1	b2	b3	R
							(± 0,2)				
JFL-10	10	12	30	14	15	4,5	22	6	2	1	4
JFL-12	12	14	36	16	18	4,5	26	6	2	1	4,5
JFL-16	16	18	48	20	24	5,5	34	6	2	1	5,5
JFL-20	20	23	60	26	30	6,5	44	10	3	2	7
JFL-25	25	28	75	30	35	6,5	55	10	3	2	8,5
JFL-30	30	34	90	36	40	8,5	66	10	3	2	10
JFL-35	35	39	95	41	55	8,5	77	10	3	2	12

iglide® T500	d1 ¹⁾	d2 ²⁾	d3	d4	d5	d6	d7	b1	b2	b3	R
							(± 0,2)				
TFL-10	10	12	30	14	15	4,5	22	6	2	1	4
TFL-12	12	14	36	16	18	4,5	26	6	2	1	4,5
TFL-16	16	18	48	20	24	5,5	34	6	2	1	5,5
TFL-20	20	23	60	26	30	6,5	44	10	3	2	7
TFL-25	25	28	75	30	35	6,5	55	10	3	2	8,5
TFL-30	30	34	90	36	40	8,5	66	10	3	2	10
TFL-35	35	39	95	41	55	8,5	77	10	3	2	12

1) Tolerance based on E10 (pin gauge measurement)

2) Press-fit in housing bore with H7 tolerance

Telephone 1-800-521-2747
Fax 1-401-438-7270

Internet: <http://www.igus.com>
email: sales@igus.com
QuickSpec: <http://www.igus.com/iglide-quickspec>

igus[®]



iglide[®] Polysorb

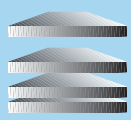

Product Range

- Inner diameters:
Metric sizes from 5.2 - 20.4 mm

Part Number Structure

Part Number Structure

J T E M- 06

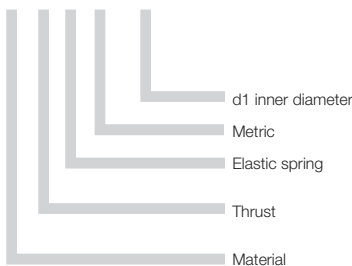

Advantages



- application requires, flat spring characteristics, which are only possible in metal at a considerable expense (slotted design)
- compensation of axial clearances and manufacturing tolerances
- vibration dampening
- noise-dampening
- electrical and thermal insulation
- no lubrication necessary
- lightweight
- low profile dimensions
- anti-magnetic



- when constant spring forces are necessary over wide temperature ranges
- when high spring forces are desired



Visit www.igus.com
to use our online
expert system

Spring washers are discs that can be axially loaded, which are concave in the axial direction on the plate surface. Polysorb disc springs require less space than other spring types. They are especially suitable for designs that demand a small spring deflection.

Material Table

General Properties	Unit	iglide® J	Testing Method
Density	g/cm ³	1.49	
Color		yellow	
Max. moisture absorption at 73°F/50% r.h.	% weight	0.3	DIN 53495
Max. moisture absorption	% weight	1.3	
Coefficient of friction, dynamic against steel	μ	0.06 - 0.18	
p x v value, max. (dry)	psi x fpm	9700	

Mechanical Properties

Modulus of elasticity	psi	348,000	DIN 53457
Tensile strength at 68°F	psi	10,585	DIN 53452
Compressive strength	psi	8,700	
Permissible static surface pressure (68°F)	psi	5,075	
Shore D-hardness		74	DIN 53505

Physical and Thermal Properties

Max. long-term application temperature	°F	194	
Max. application temperature, short-term	°F	248	
Min. application temperature	°F	-58	
Thermal conductivity	W/m x K	0.25	ASTM C 177
Coefficient of thermal expansion (at 73°F)	K ⁻¹ x 10 ⁻⁵	10	DIN 53752

Electrical Properties

Specific volume resistance	Ωcm	> 10 ¹³	DIN IEC 93
Surface resistance	Ω	> 10 ¹²	DIN 53482



Polysorb Disc Springs in a fatigue test

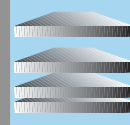

Chemical Resistance

Polysorb disc springs are acid-resistant against diluted lyes and very weak acids, as well as against fuels and all types of lubricants. The small moisture absorption permits the use in wet or moist environments.

Medium	Resistance
Alcohol	+
Hydrocarbons, chlorinated	+
Greases, oils without additives	+
Fuels	+
Weak acids	0 to -
Strong acids	-
Weak alkaline	+
Strong alkaline	+ to 0

Chemical resistance of Polysorb

Moisture Absorption

Polysorb disc springs absorb moisture. In the process, their mechanical properties change. However, in the worst application case - a long lasting use in water - Polysorb disc springs still have a maximum spring force of 2.24 lbs.

Force and Temperature

Force and temperature are two factors that influence the spring force and the amount of time the spring force will hold. See the graphs below for detailed information.

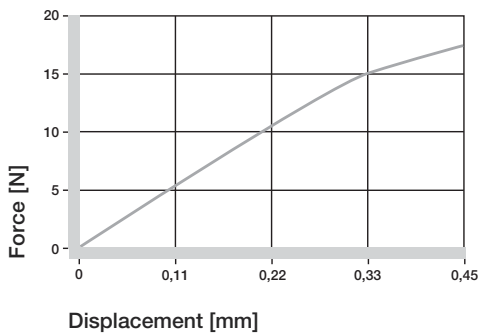

Experimental test results between the force ratio $F/F_{1,0}$ and the spring length ratio S/h_0 ($S_{1,0} = H_0$)

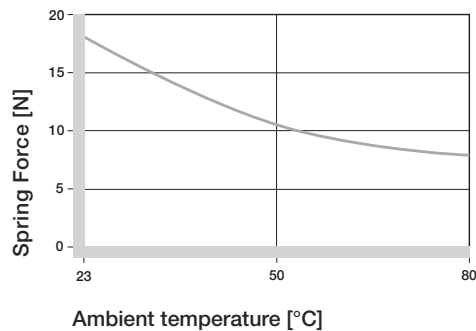

Effect of ambient temperature on the spring force

PDF: www.igus.com/iglide-pdfs
CAD: www.igus.com/iglide-CAD
RoHS info: www.igus.com/RoHS

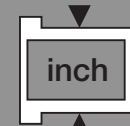
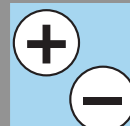

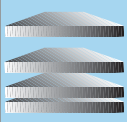

iglide® Polysorb
JTEM - MM

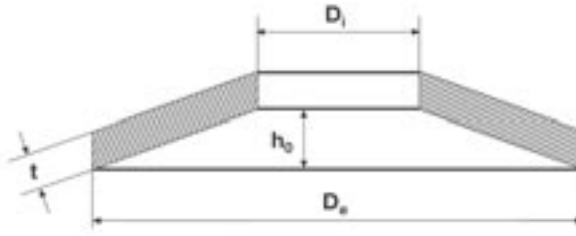

Dimensions based on DIN 2093

Part Number	Standard values: spring lengths and forces											
	D_i (mm)	D_e (mm)	t (mm)	h_0 (mm)	$S_{0.25}$ (mm)	$F_{0.25}$ (lbs)	$S_{0.5}$ (mm)	$F_{0.5}$ (lbs)	$S_{0.75}$ (mm)	$F_{0.75}$ (lbs)	$F_{1.0}$ (lbs)	M (g)
JTEM-05	5.2	10.0	0.5	0.25	0.06	.22	0.13	.54	0.19	.81	1.12	0.04
JTEM-06	6.2	12.5	0.7	0.30	0.08	.67	0.15	1.15	0.23	1.80	2.70	0.11
JTEM-08	8.2	16.0	0.9	0.35	0.09	.90	0.18	1.80	0.28	2.47	2.70	0.20
JTEM-10	10.2	20.0	1.1	0.45	0.11	1.12	0.22	2.25	0.33	3.37	4.05	0.33
JTEM-12	12.2	25.0	1.5	0.55	0.14	2.02	0.28	4.05	0.42	6.07	7.87	0.85
JTEM-16	16.3	31.5	1.75	0.70	0.18	3.37	0.35	7.19	0.53	11.46	15.74	1.44
JTEM-20	20.4	40.0	2.25	0.90	0.23	7.87	0.45	15.74	0.68	24.73	31.47	3.10

The standard values for the spring lengths and forces represent rounded average values

Telephone 1-800-521-2747
Fax 1-401-438-7270

Internet: <http://www.igus.com>
email: sales@igus.com
QuickSpec: <http://www.igus.com/iglide-quickspec>

- F = Force
- S = Spring Length
- D_e = Outside diameter (mm)
- D_i = Inside diameter (mm)
- t = Thickness of one plate
- h_0 = Maximum spring (mm)
- $S_{0.25}$ = 25% of the maximum spring length (mm)
- $F_{0.25}$ = Spring force at 25% spring (N)
- $S_{0.5}$ = 50% of the maximum spring length (mm)
- $F_{0.5}$ = Spring force at 50% spring (N)
- $S_{0.75}$ = 75% of the maximum spring length (mm)
- $F_{0.75}$ = Spring force at 75% spring (N)
- $F_{1.0}$ = Spring force 100% spring (N)
- M = Weight of a single plate (g)

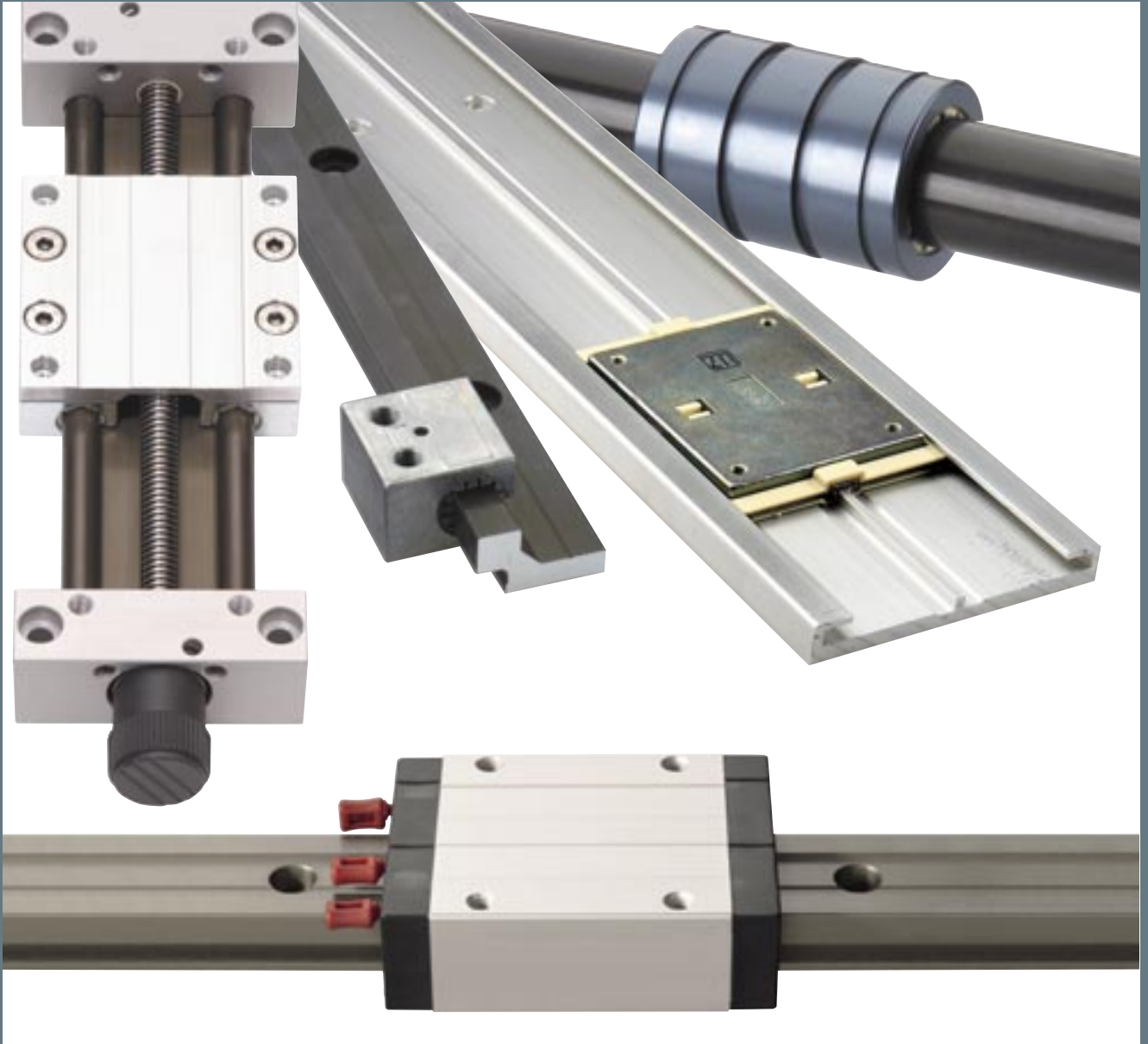

DryLin[®] Design Guide

DryLin® N Low Profile Guides

DryLin® W Flexible Guiding System

DryLin® Overview



The DryLin® Story

We perform over 2,500 tests per year on hundreds of bearing materials specifically formulated for maintenance-free operation, without lubrication. As a result of this testing we have determined that our iglide® J, J200 and T500 are ideal materials for most linear bearing applications due to their excellent wear properties and low coefficients of friction. Unlike older bearing technology, DryLin® Linear Plain Bearings are engineered to run dry, without the need for messy lubricants or costly maintenance and downtime; expensive and cumbersome grease lines may be eliminated from the design entirely. Dirt, dust, and other abrasives will not be drawn into the bearing surface, making DryLin® ideal for aggressive environments, as well as for high moisture, wash-down, and even underwater applications.

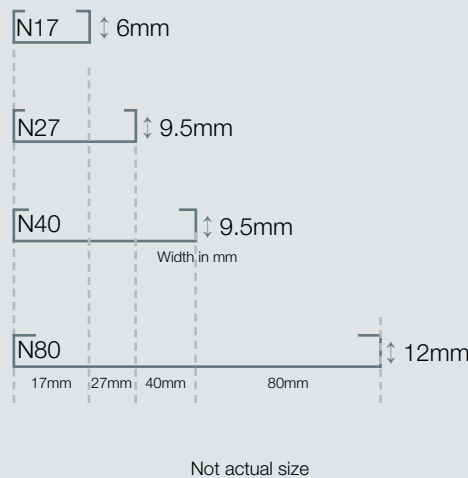

DryLin® N Low Profile Guide Rails

The DryLin® N series offers extremely low profiles in several widths, and is therefore ideal in tight space constraints. Like all DryLin® products the carriages glide smoothly on anodized aluminum rails without the need for messy lubricants. They are also available in preloaded versions for reducing running clearance. DryLin® N is a particularly low-coat alternative to miniature ball bearing systems, and is more precise and economical when compared to many custom-machined or simple plastic parts.

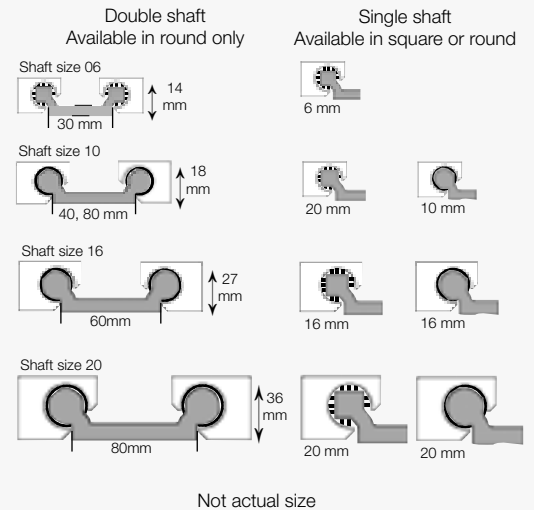

DryLin® W Flexible Linear Guide System

DryLin® W was developed to promote design flexibility and quick assembly in both single and double rail configurations. DryLin® W is also offered as a pre-mounted, bolt-on system - eliminating the need for timely shaft alignment and carriage assembly. All DryLin® W systems are available with our enhanced J200 liners, which reduces friction and optimizes bearing life.

- The single rail system, which can incorporate a floating square linear bearing, compensates efficiently for extreme shaft misalignments.
- The double rail system totally eliminates the need for shaft alignment, offering a single, bolt-on solution.
- Available in 316 Stainless Steel

DryLin® T Linear Guide System

DryLin® R Linear Bearings/Shafting

DryLin® Slide Tables

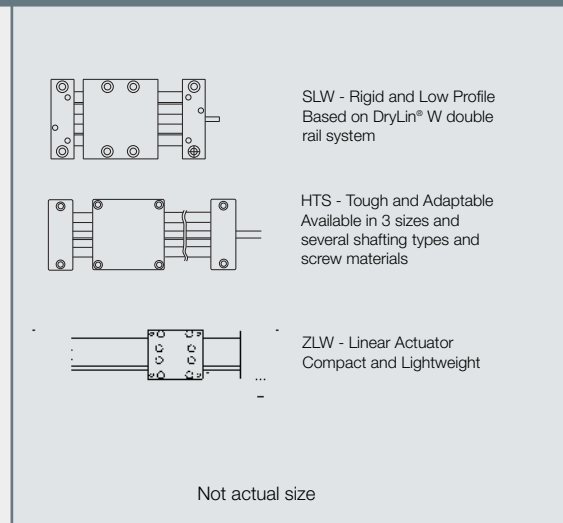
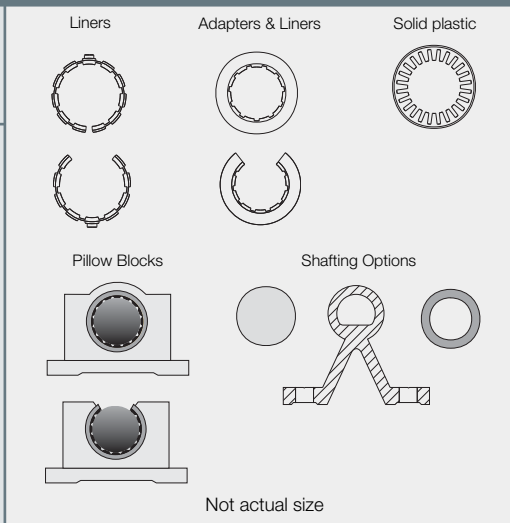
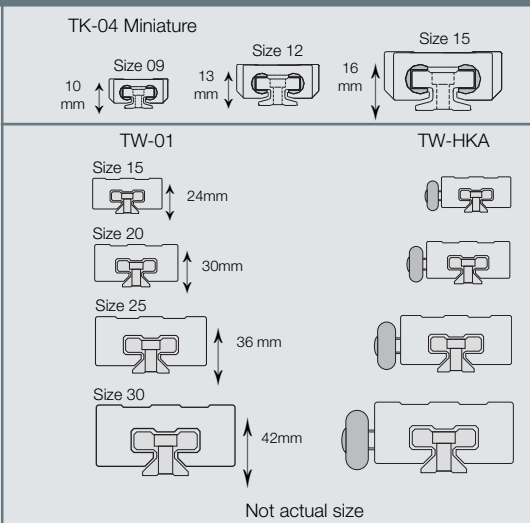
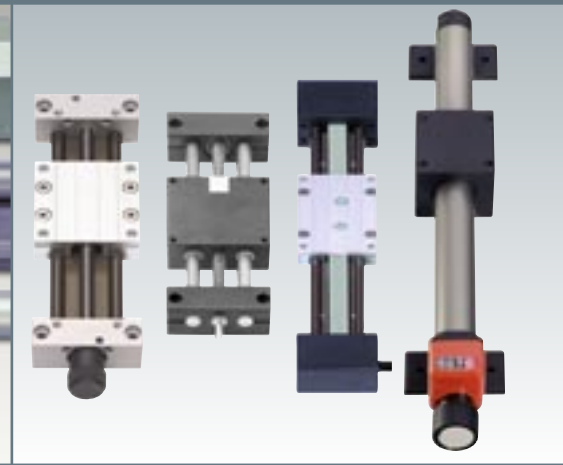

DryLin® T Profile Guide Rails

DryLin® T guide rails are dimensionally interchangeable with recirculating ball guides, but offer cost-effective, maintenance-free operation. Series 01 offers adjustable clearance, and the mini 04 series is ideal for use in tight design constraints. Both use iglide® J glide pads and hard-anodized aluminum rails for optimal friction and wear resistance.

- Permits adjustments to the play of guidance systems (Series 01)
- Very resistant to dirt
- Very low coefficient of friction and wear

DryLin® R Shaft Guide

DryLin® R is dimensionally interchangeable with other linear bearings, but offers clean, cost-effective results, suitable for many shaft materials. The liner offers excellent clearance, and makes DryLin® R suitable for use in extremely wet and dirty environments – they are also easily replaceable. DryLin® S shafting is the optimal shafting for the iglide® J material - increasing lifetime up to 50% vs. steel shafting.

- Hard anodized aluminum shafts used with DryLin® linear bearings are ideal for applications in which weight reduction and/or high service life is required.
- DryLin® with stainless steel shafts provide excellent chemical resistance and is an ideal solution for applications in the food and packaging industry

DryLin® Slide Tables

SLW/HTS

DryLin® Slide Tables are maintenance-free and offered in both belt and screw drives for simple bolt-on assembly. Offering design flexibility and corrosion-resistance, they are also ideal as a low cost solutions for reduced production and assembly time.

ZLW

High speed belt-driven tables for velocities up to 15 fps (5m/s)

SET Easy Tube

Simple, but and effective and solid design: that's the new DryLin® SET Easy Tube. A complete system from few components for simple linear adjustments.

DryLin® Selection Guide



DryLin® N Low Profile Guides

- Low profile for tight design constraints
- Low cost
- No lubrication needed
- Preloaded systems available for reduced clearance
- Extremely lightweight



Storage Solutions for a Tape Library



DryLin® W Flexible Guiding System

- Modular design offers flexible design configurations
- Low cost
- 316 stainless systems available
- Double rail eliminates the need for shaft alignment
- Easy to assemble



Flatbed Ink-Jet Printer

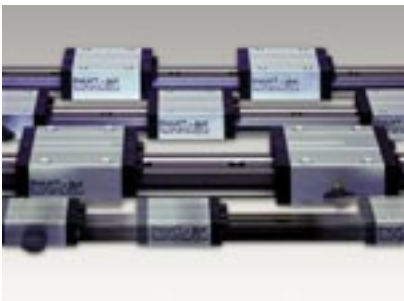

DryLin® T Linear Guide System

- Low cost alternative to ball bearing profile systems
- Dimensionally interchangeable with ball bearing system
- No lubrication or maintenance required
- Adjustable clearance standard on some series
- Lightweight
- Corrosion-resistant



Mailroom Machinery



DryLin® R Linear Bearings/Shafting

- Low cost alternative to recirculating ball bearings
- Dimensionally interchangeable with ball bearings and PTFE-lined systems
- Replaceable liners
- Corrosion-resistant
- Works on many shaft materials, even aluminum and 300-series stainless steel



Machining Center

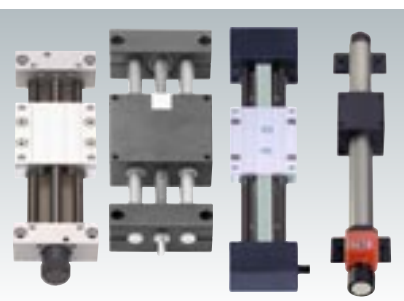



DryLin Slide Tables

- Bolt-on systems reduce design and assembly time
- Available in screw and belt-actuated designs
- Corrosion-resistant materials available
- Cost-effective compared to other ball bearing stages

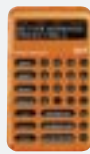

High Dirt Resistance

Maximum Static Load	Maximum Surface Speed Linear	Maximum Application Temperature	Rail/Shaft Material	Online Calculator	Section
225 lbs	49.2 ft/s (15 m/s)	-40°F to 194°F (-40°C to +90°C)	anodized aluminum	 Online Lifetime Calculation www.igus.com	26
Mounted System 2,877 lbs Single Bearing 719 lbs	49.2 ft/s (15 m/s)	-40°F to 194°F (-40°C to +90°C)	hard anodized aluminum, anodized aluminum 316 stainless steel	 Online Lifetime Calculation www.igus.com	27
3,140 lbs	49.2 ft/s (15 m/s)	-40°F to 194°F (-40°C to +90°C)	hard anodized aluminum	 Online Lifetime Calculation www.igus.com	28
>11,240 lbs	49.2 ft/s (15 m/s)	iglide® J -40°F to 194°F (-40°C to +90°C) iglide® T500 148° to 482°F (-100° to 250°C)	hard anodized aluminum, anodized aluminum, case hardened steel, chrome plated steel, stainless steel,	 Online Lifetime Calculation www.igus.com	29
Screw driven 2,200 lbs Belt driven 65 lbs (300 N)	Screw Driven 3.9 fpm (x m/s) Belt Driven 16.4 fpm (5 m/s)	-40°F to 194°F (-40°C to +90°C) HTC High Temp 350°F	Screw Driven Hard anodized aluminum, steel, stainless steel, chrome-plated Belt Driven Hard anodized aluminum		30

DryLin®: Sliding instead of Rolling

DryLin® is a range of maintenance-free, lubrication-free linear slide bearings consisting of four main product lines. Principal features, in addition to zero maintenance, are strength and resistance to external influences such as corrosion, moisture, chemicals, heat and impact.

Features

- Predictable, long life
- Self lubricating and oil-free
- Maintenance-free
- Dirt and dust resistant
- Replaceable liners
- Supports high static loads
- Needs no messy grease lines
- Lightweight
- Runs on soft and hard shafts
- Constant coefficient of friction
- Short strokes and high accelerations
- Withstands shocks and vibrations
- Dimensionally interchangeable
- Corrosion-free

Benefits

- = Confidence in design and operation
- = Eliminate down time and messy lubricants
- = Save money
- = Ideal for harsh environments
- = Lower costs
- = Eliminate shaft damage
- = Cleaner, simpler design
- = Less transportation costs and fatigue
- = More options, including cost-effective shafts
- = Smooth movements over design lifetime
- = No scoring or replacement of shafting
- = Reduces stress on other components
- = No redesign/drop-in replacements available
- = Ideal for high moisture/wash down/chemicals

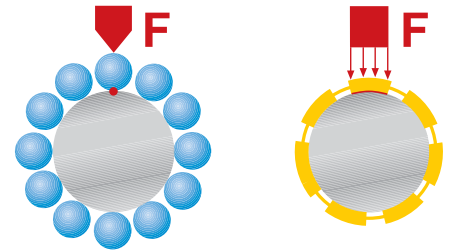

Lower surface pressure

DryLin® linear bearings work through the use of sliding elements, in contrast to the design of recirculating ball bearing systems. This results in a larger contact surface and to a much lower pressure. The advantages are:

- No scoring or galling of shaft
- Compatible with non-hardened shafts



Ball bearing system

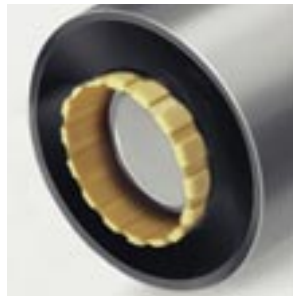

igus® DryLin® linear bearings

Dry running, without lubrication

DryLin® does not require costly maintenance or additional components such as grease lines to function. Designed for dry running, DryLin® linear bearing systems run without grease or oil; this permits operation even applications with dirt or washdowns- the bearing liners are designed to act as wipers by removing debris from the system.

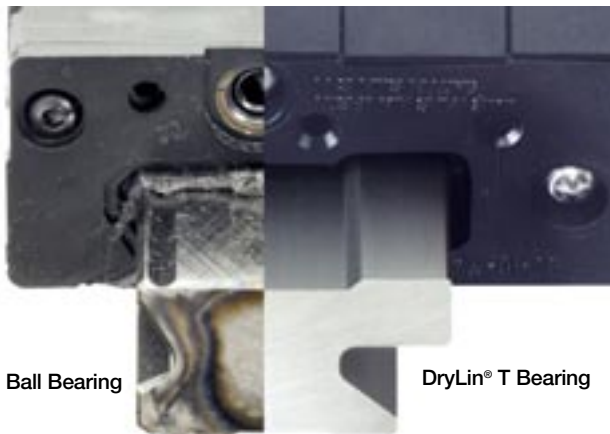

Ball Bearing

DryLin® T Bearing

Resistant to dirt, dust and moisture

Works well with short strokes

Compared with recirculating ball bushings, DryLin® bearings' operating characteristics do not depend on the length of travel. Even applications with extremely short strokes are no problem for DryLin® linear bearings.

Quiet operation

The smooth operation is also attributable to the difference between rolling and sliding (see graph at the left): No mechanical rolling against hard surfaces, no collisions between balls resulting in loud running noises. Sliding motion is extremely quiet, only a low "swishing" noise is heard. Many customers prefer the feel of DryLin® for manual operations

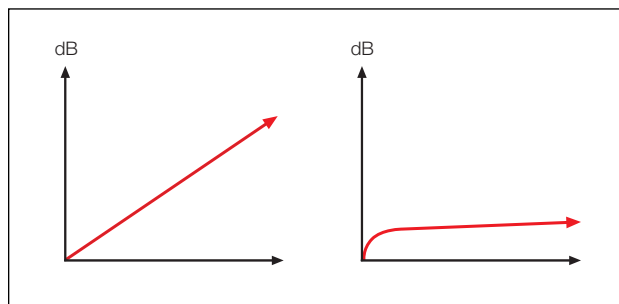

Comparative noise generation

DryLin® Linear Plain Bearings

Telephone 1-800-521-2747
 Fax 1-401-438-7270

Internet: <http://www.igus.com>
 email: sales@igus.com
 QuickSpec: <http://www.igus.com/iglide-quickspec>

Suitable Materials for the DryLin® Series

	DryLin® T	DryLin® N	DryLin® W	DryLin® R
iglide® J	●	●	●	●
iglide® J200 ¹⁾	-	-	●	●
iglide® T500 ²⁾	-	-	-	●

¹⁾ Use only with hard anodized aluminum
²⁾ Use only with hardened shafts, preferably stainless steel or chromed shafts

● suitable - not available

iglide® – Coefficients of friction

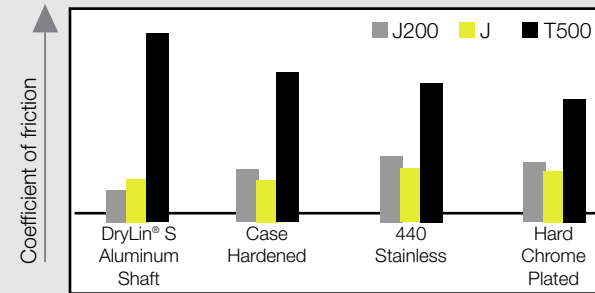

The coefficient of friction - Not just simple plastics

All DryLin® materials are characterized by excellent coefficient of friction values in dry operation. DryLin® linear guide systems can reach coefficients of friction as low as 0.12 without any additional lubricants. Depending on the load, the kind of application and the environmental conditions, this value might be 2 to 3 times higher.

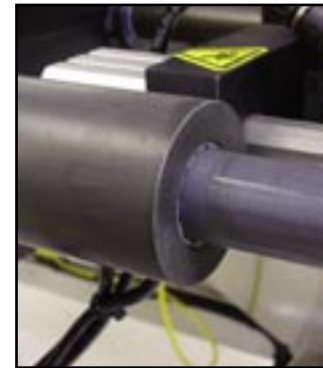

J200 on DryLin® S hard-anodized shafting

iglide® J – various shaft materials

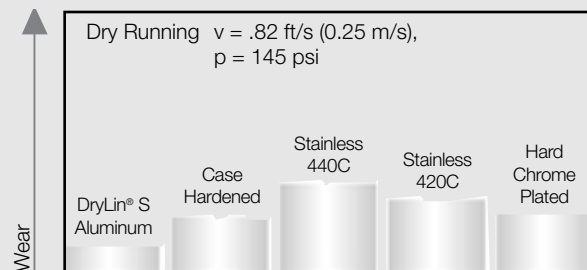

The iglide® J material

Comprehensive laboratory tests showed that iglide® J is by far the most suitable polymer material for most linear motion applications. Special characteristics of iglide® J:

- Lowest coefficient of friction on all materials overall
- Very low abrasion values during dry operation
- Excellent wear resistance
- Maintenance free dry operation
- Vibration dampening
- Very low moisture absorption
- Recommended for all shaft materials

iglide® T500 – various shaft materials

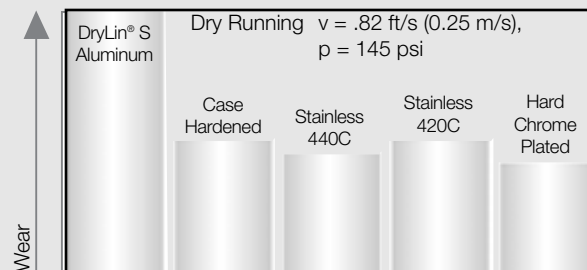

The iglide® T500 material

iglide® T500 is defined by its combination of high temperature resistance with compressive strength, along with high resistance to chemicals. iglide® T500 achieves the best wear results with hardened stainless steel and case-hardened chrome plated steel shafts. Special characteristics:

- Temperature resistant from -148°F to +482°F in continuous operation
- Universal resistance to chemicals
- High compressive strength
- Very low moisture absorption
- Great wear resistance through the entire temperature range

DryLin® Linear Plain Bearings

PDF: www.igus.com/iglide-pdfs
 CAD: www.igus.com/iglide-CAD
 RoHS info: www.igus.com/RoHS





Online
Lifetime
Calculation

www.igus.com



DryLin® Linear Plain Bearings

Telephone 1-800-521-2747
 Fax 1-401-438-7270

Internet: <http://www.igus.com>
 email: sales@igus.com
 QuickSpec: <http://www.igus.com/iglide-quickspec>

Loading Capacity

Static Load Capacity

Since there is no point-to-point contact with DryLin®, as there is with ball bearing systems, the static load capabilities of DryLin are extremely high. At the right find the maximum static load for the largest bearing in each series:

Series	Max Static Load
DryLin R	20,000 lbs
DryLin T	3,140 lbs
DryLin W	719 lbs
DryLin N	220 lbs

Dynamic Load Capacity

The dynamic load capacity is related to the continuous application speed as shown in Graph 25.1, this is due to the P•V value of the iglide® J material. The lower the surface speed, the higher the permissible dynamic load. Our available Online Expert System quickly and easily checks the functionality of a particular DryLin® system for your application, and is available at www.igus.com. It will give warning if the load capacity of a certain bearing is exceeded.

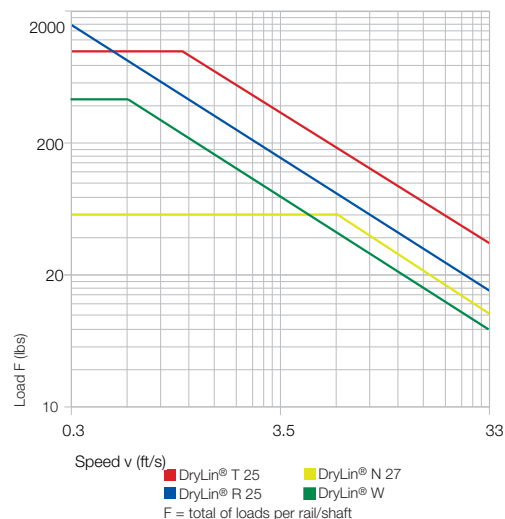

Graph 25.1: F x V values of comparable DryLin® systems

Permissible Speeds

With low loads DryLin® has been tested at speeds up to 49 fps (15 m/s). The maximum permissible speed is related to the bearing load - the lower the load the higher the permissible speed. Since DryLin® does not rely on complicated rolling elements, but instead on specially engineered, low wear, low friction glide strips, extremely high speeds and accelerations are now possible. This means that DryLin® is ideal for applications where cycle and accelerations must be increased.

More significant than the maximum speed is the average speed-per-cycle time. Therefore, in order to calculate the suitability of a particular DryLin® system, the average surface speed should be determined. In applications with intermittent cycles, the highest average surface speed is significant; this is an average taken over a 10-30 minute time period

The use of DryLin® S hard anodized aluminum as a shaft material decreases the operating temperature in the bearing system due to its thermal conductivity and micro-finish. It is recommended for most applications with short-strokes or high cycles when using the iglide® J/J200 material liners. It is the material we have designed for use with all of our profile guides as well.

Eccentric Forces

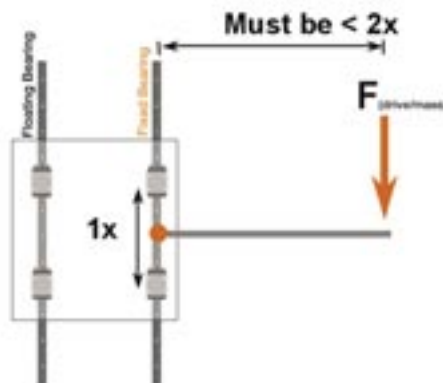

The 2:1 Rule

When using linear plain bearings it is important to ensure that the acting forces follow the 2:1 Rule (see drawing). If either the load or the drive force (F) is greater than twice the bearing length (1X), then a binding or interrupted motion may occur.

If the location of the drive force or load cannot be changed, simply increase the distance between the bearings, or create a counterbalance to move the center-of-gravity back within the 2 to 1 ratio.

Online Lifetime Calculation
www.igus.com

2:1 Rule = permissible distances of the applied forces

Coefficients of Friction

DryLin® R linear plain bearings provide excellent coefficients of frictions while running dry. The coefficients of friction μ is strongly affected by the shaft material, the running speed, the temperature, and the surface load.

After a short start-up phase, during which the coefficient of friction stabilizes, the coefficient of friction is considered constant over the total lifetime for DryLin® bearings. Graph 25.2 shows the coefficients of friction of linear plain bearings with iglide® J on different shaft materials.

Loads and surface speeds have a large effect on the coefficients of friction of linear systems. An increase of the load at a constant speed lowers the coefficient of friction (Graphs 25.3 and 25.4).

Under constant loads, the coefficient of friction increases slightly with increased speeds. (Graphs 25.6 and 25.7).

The temperature in the bearing area influences the coefficient of friction starting at approximately 149°F. Over the permissible operating temperature of 194°F, a large increase in the coefficients of friction is to be expected. (Graph 25.5).

The coefficients of friction of a plain bearing are clearly higher compared to the data for recirculating ball systems. These differences must be taken into account in the design of linear applications.

Although DryLin® linear guide systems have clear advantages in applications with high amounts of dirt, the coefficients of friction in dirty applications also increase. It was observed that the stability of the coefficients of friction are not the same in extreme application conditions.

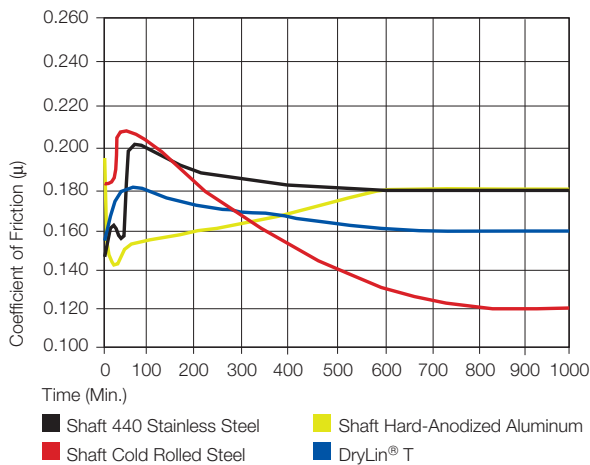

Graph 25.2: DryLin® long-term progression of the coefficient of friction, p = 130 psi, v = 29.5 fpm

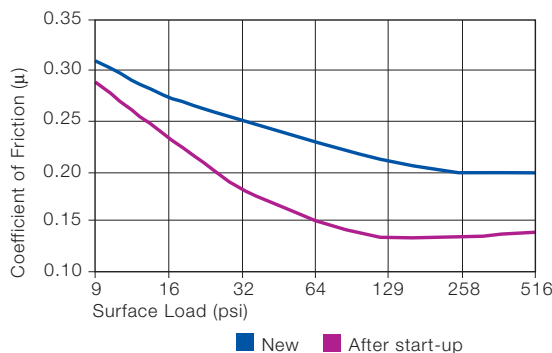

Graph 25.3: Coefficient of friction under load/DryLin® R, v = 29.5 fpm

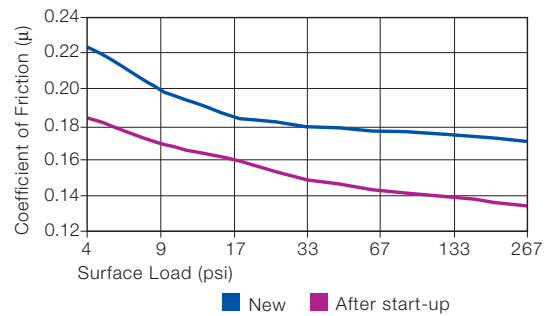

Graph 25.4: Coefficients of friction under load/DryLin® T, v = 29.5 fpm

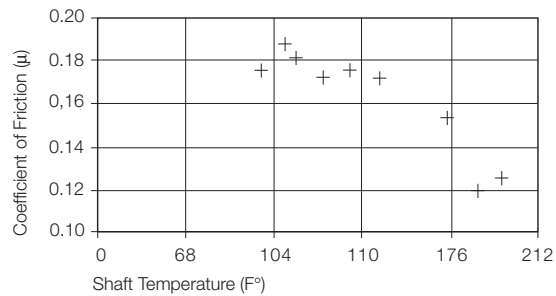

Graph 25.5: Coefficients of friction as a result of the temperature iglide® J versus Aluminum hc, v = 59 fpm, p = 130 psi

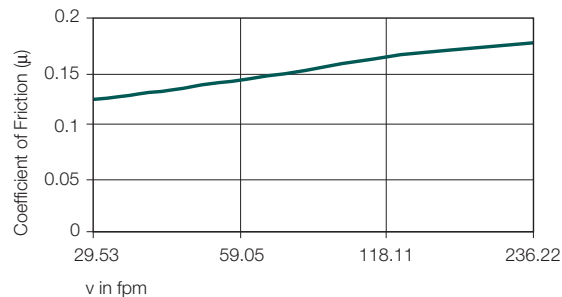

Graph 25.6: Coefficient of friction as a result of the speed/DryLin® R, p = 130 psi

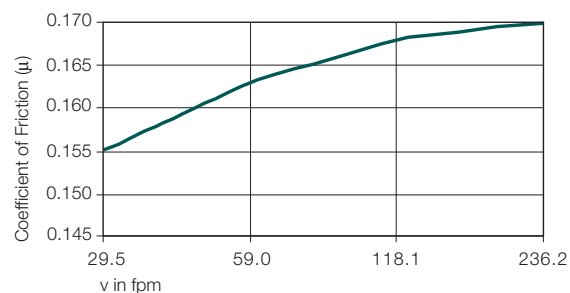

Graph 25.7: Coefficient of friction as a result of the speed/DryLin® T, p = 67 psi



Wear Behavior

The wear behavior of DryLin® R linear plain bearings is a result of the shaft material. iglide® J works well on many different materials. The surface load, in addition to the shaft material and roughness, has an effect on the wear. With decreasing surface load, the wear also decreases.

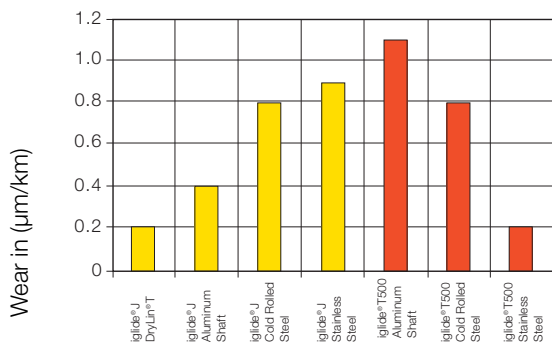

Graph 25.8: Wear in µm/km for different sliding partners, p = 145 psi

See our Online Expert System and ...



Online Lifetime
Calculation
www.igus.com

Stick-Slip Behavior

Stick-slip occurs when there is intermittent movement between two sliding partners. The stop and go movement is caused by frequent changes from static to dynamic friction.

The coefficients of static and sliding friction are close enough to each other for iglide® J that the danger of stick-slip behavior is very low (Table 25.1).

	Coefficient of Static Friction	Coefficient of Dynamic Friction
J/ Cold Rolled Steel	0.16	0.13

Table 25.1: Coefficients of friction

Operating Temperatures

iglide® J Material

Sliding elements made of iglide® J can be used in the temperature range between -40°F and 194°F. Because of the excellent heat conductivity of aluminum as a shaft and housing material, a large increase in bearing temperature only occurs in high-frequency short-stroke applications with a high load.

Temperature limits for iglide® J

iglide® J	Application Temperature
Minimum	-40 °F
Max., long-term	+194 °F
Max., short-term	+248 °F

iglide® T500 Material

T500 liners were developed specifically for high temperature and chemical applications, and run particularly well on stainless-steel shafting.



iglide® T500 material for heavy-duty operation at high temperatures in foundries

Temperature limits for iglide® T500

iglide® T500	Application Temperature
Minimum	- 148 °F
Max., long-term	+ 482 °F
Max., short-term	+ 599 °F

Chemical Resistance

iglide® J is resistant to weak acids, diluted lyes and to fuels and all types of lubricants. Even the frequent chemical washdowns of machines in the food industry are not a problem for DryLin® linear plain bearings.

T500 liners were developed specifically for chemical resistance and high temperature applications. T500 liners run particularly well when combined with stainless steel shafts, which are also recommended for chemical resistance.

Medium	iglide® J Resistance	iglide® T500
Alcohol	Resistant	Resistant
Chlorinated hydrocarbons	Resistant	Resistant
Ester	Not Resistant	Resistant
Greases, oils	Resistant	Resistant
Ketones	Conditionally Resistant	Resistant
Fuels	Resistant	Resistant
Weak acids	Conditionally Resistant	Resistant
Strong acids	Not Resistant	Conditionally Resistant
Weak lyes	Resistant	Resistant
Strong lyes	Resistant	Resistant
Sea water	Resistant	Resistant

Table 25.3: Chemical resistance of iglide® J and iglide® T500

Corrosion Behavior

The low moisture absorption of iglide® J and T500 allows design in underwater areas. With the use of stainless steel shafts or anodized aluminum, a corrosion resistant guide results. Anodized aluminum is resistant to chemically neutral materials in the PH range 5 to 8. For special applications it is recommended to test coated aluminum sample parts to examine results prior to their use.



Golden manus® winner for Inspection equipment for offshore drilling riserplant with iglide® G300 and DryLin® N

Clean Room Suitability and ESD Compatibility

All DryLin® guide systems are qualified for cleanroom applications. The differentiation between the various cleanroom classes is only dependent on load and speed of the application. The combination of iglide® J and hard anodized aluminum is classified as level 1 in the ESD compatibility according to SEMI E78-0998 (Highest rank).

The following DryLin® guide systems were examined: N40, W10, T25 and T30. See ► page 25.12 for detailed results.



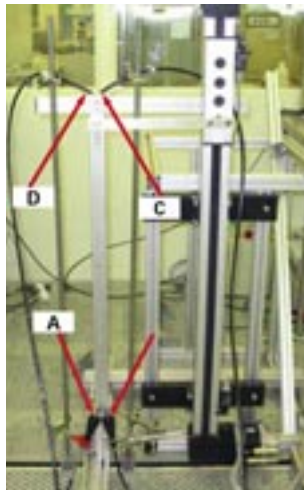

Photographs of the measuring points MP1 to MP4 of the linear bearing DryLin® NK-02-40-02 used for the airborne particle emission measurements

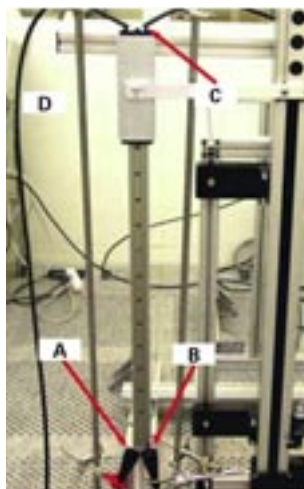
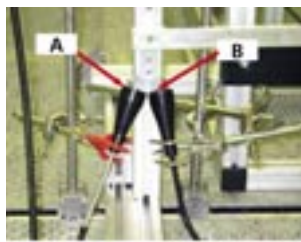

Photographs of the measuring points MP1 to MP4 of the linear bearing DryLin® TK-01-25-02 used for the airborne particle emission measurements

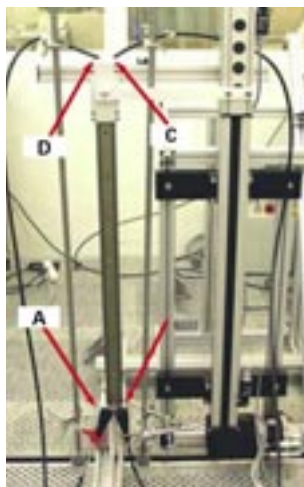
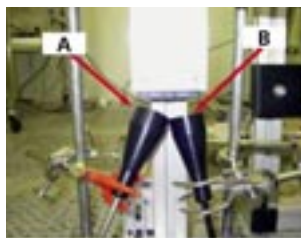
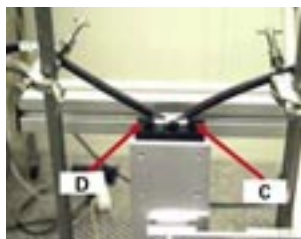

Photographs of the measuring points MP1 to MP4 of the linear bearing DryLin® WK-10-40-15-01 used for the airborne particle emission measurements

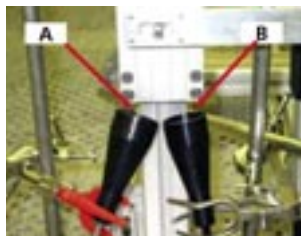
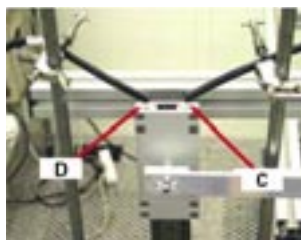

All DryLin®-Guides are clearly qualified for clean room applications. The differentiation between the various clean room classes is only dependent on load and speed of the application. The combination of iglide® J and hard anodized aluminum is classified as level 1 in the ESD compatibility according to SEMI E78-0998 (Highest rank).

The following DryLin®-Guides have been examined: N40, W10, T25 and T30. Detailed results can be found below:

Linear guide DryLin® TK-10-30-01

"For the linear guiding system DryLin® TK-10-30-01 by igus®, it is possible, on the calculations of the likelihood of violation of the threshold values of the detection sizes 0.2 µm, 0.3 µm, 0.5 µm and 5 µm with a motion speed of $v = 0.1$ m/s, to clearly derive a suitability for clean rooms classified as ISO-Class 3 according to DIN EN ISO 14644-1".

Linear guide DryLin® NK-02-40-02

"For the linear guiding system DryLin® NK-02-40-02 by igus®, it is possible, on the calculations of the likelihood of violation of the threshold values of the detection sizes 0.2 µm, 0.3 µm, 0.5 µm and 5 µm with a motion speed of $v = 1$ m/s, to clearly derive a suitability for clean rooms classified as ISO-Class 6 according to DIN EN ISO 14644-1".

The measurement results of the ESD compatibility according to SEMI E78-0998 show that the linear guiding system DryLin® NK-02-40-02 can be classified "level 1" (highest rank). See Fraunhofer IPA Report No.: IG 0308-295 73.

Linear guide DryLin® TK-01-25-02

"For the linear guiding system DryLin® TK-01-25-02 by igus®, it is possible, on the calculations of the likelihood of violation of the threshold values of the detection sizes 0.2 µm, 0.3 µm, 0.5 µm and 5 µm with a motion speed of $v = 1$ m/s, to clearly derive a suitability for clean rooms classified as ISO-Class 5 according to DIN EN ISO 14644-1".

The measurement results of the ESD compatibility according to SEMI E78-0998 show that the linear guiding system DryLin® TK-01-25-02 can be classified "level 1" (highest rank).

Linear guide DryLin® WK-10-40-15-01

"For the linear guiding system DryLin® WK-10-40-15-01 by igus®, it is possible, on the calculations of the likelihood of violation of the threshold values of the detection sizes 0.2 µm, 0.3 µm, 0.5 µm and 5 µm with a motion speed of $v = 1$ m/s, to clearly derive a suitability for clean rooms classified as ISO-Class 6 according to DIN EN ISO 14644-1".

The measurement results of the ESD compatibility according to SEMI E78-0998 show that the linear guiding system DryLin® WK-10-40-15-01 can be classified "level 1" (highest rank). See Fraunhofer IPA Report No.: IG 0308-295 74.

DryLin® Linear Plain Bearings: Floating Bearing/Self-Alignment



DryLin®

Fixed and Floating Bearing Mounting Instructions

When using systems with 2 parallel rails, one side must be designated as the “fixed” rail, and the opposite side as the “floating” rail.

Why use floating bearings?

- promotes smooth gliding performance and maximizes bearing life
- prevents binding caused by parallelism and angle errors
- decreases necessary drive force and wear by minimizing friction-forces
- Enhances the precision of the system over the bearings’ lifetime.
- Reduce assembly time and cost



Online Lifetime
Calculation
www.igus.com

Fixed Bearings

The “fixed” bearing rail should be positioned closest to the drive force. This rail will determine the precision of the system; no system should contain more than two “fixed” bearings.

Floating/Self-Aligning Bearings

The “floating” rail should be the rail located furthest from the drive force. It is to act only as a guide, and will compensate for any misalignments or angle errors in the system ensuring proper functionality.

Mounting Surfaces

The mounting surfaces for rails and bearings should have a very flat surface (e.g milled surface) in order to enhance performance. Variations in these surfaces may be compensated for by using floating bearings.

DryLin® N - Floating Systems

Maximum float = .02” (.5 mm)



Standard Version



Horizontal Float “LLZ”

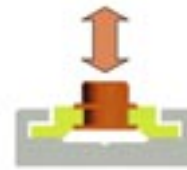

Vertical Float “LLY”

DryLin® W - Floating Systems

Maximum float = .08” (2 mm)



Standard Version

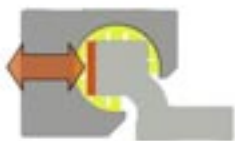

Horizontal Float “LLZ”



Vertical Float “LLY”



DryLin® W can also alleviate edge pressure
Ideal for non-flat, even surfaces

DryLin® T - Floating Systems

Maximum float = .04” (1 mm)



Standard Version



Horizontal Float “LLZ”



Vertical Float “LLY”

DryLin® Linear
Plain Bearings

PDF: www.igus.com/iglide-pdfs
CAD: www.igus.com/iglide-CAD
RoHS info: www.igus.com/RoHS



DryLin® R

DryLin® R linear plain bearings in the 03 Design Series are self-aligning and offer great advantages in applications with parallel shafts. They are able to compensate for alignment and parallelism errors and should be used on the shaft located furthest from the drive mechanism.

The design provides a raised spherical area on the outer diameter of the aluminum adapter for self-alignment. Load capacity is the same as the fixed version.

Even in unfavorable edge-load conditions, the load is supported by the entire projected surface

In order to compensate for parallelism errors between two shafts, the outer diameter is designed to be smaller than the

housing bore diameter by 0.2 - 0.3 mm (depending on the size). With the use of mounted O-rings, these bearings have an elastic bearing seat.

Compensation for angle errors

Series RJUI/RJUM/OJUI/OJUM-03	±0.5°
Series RJUM-06-LL/OJUM-06-LL	±3.5°

Compensation of parallelism errors

Series RJUI/RJUM/OJUI/OJUM-03	±0.1 mm (.004")
Series RJUM-06-LL/OJUM-06-LL	±3 mm (.12")

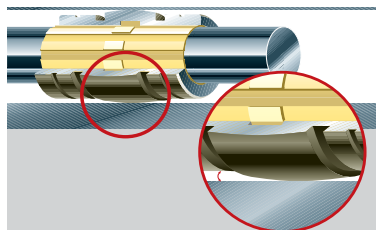

The spherical DryLin® adapters can compensate for alignment errors. A hard-anodization protects the aluminum adapter from wear.

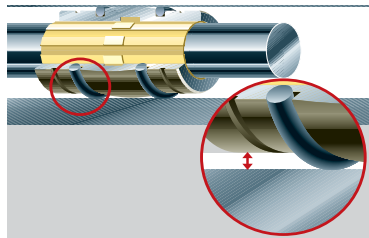

With built in clearances and the use of O-rings, the self-aligning DryLin® R bearings of the 03 Design Series can compensate for parallelism errors.



The self-aligning DryLin® R bearings of the 06 LL design series can compensate parallelism errors up to ± .12" (3mm).

DryLin® T Shown As Example Only

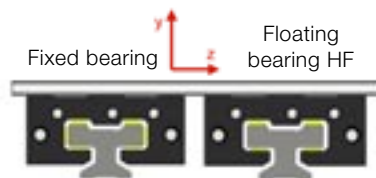

Installation variation horizontal with floating bearing in the Z-direction

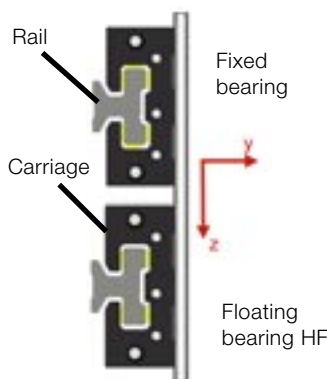

Installation variation lateral with floating bearing in the Z-direction

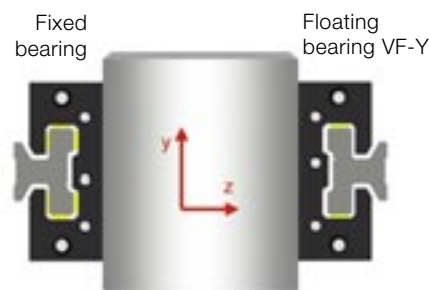

Horizontal mounting version with floating bearing in the Y-direction and lateral mounting carriage

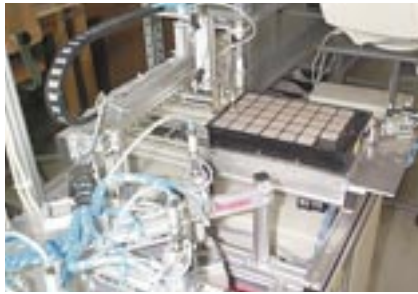

Testing and sorting machines



Storage solutions for a tape library



DryLin® N

DryLin® Linear
Plain Bearings



Feeding systems for a blister machine



Flatbed ink-jet printers

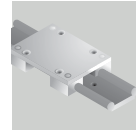

DryLin® W

PDF: www.igus.com/iglide-pdfs
CAD: www.igus.com/iglide-CAD
RoHS info: www.igus.com/RoHS



Packaging machines



Machining centers for the furniture industry

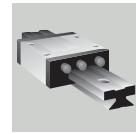

DryLin® T



Machining Center



Packaging technology



DryLin® R



Positioning of milling heads



Height-adjustment for an encoding machine



DryLin® HTS





DryLin[®] N Low Profile
Linear Guide System

DryLin® N Selection Guide

Available Carriages



DryLin® N17

- Good for tight design constraints
- Low cost
- Excellent for low loads
- Excellent corrosion resistance



Standard



Preload



Double Carriage



DryLin® N27

- Through hole for flexible mounting
- Threaded boss for easy attachment
- Extremely low friction/low wear
- Replaceable glide pads
- Low weight
- Flexible size
- Excellent for low to medium loads



Standard/holes



Standard/thread



Preload



Overmolded



iglide® J carriage
Double length
with thread



Zinc carriage
Double length
with holes



DryLin® N40

- Flexible size
- Replaceable glide pads
- Excellent for medium to high loads
- Wide base for stable design



Standard/holes



Standard/thread



Overmold/holes



Overmold/thread

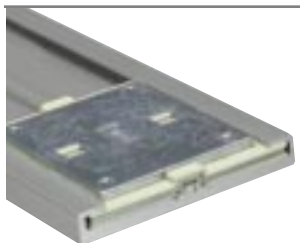

DryLin® N80

- Use one rail instead of two narrow rails
- High accelerations possible
- Replaceable glide pads
- Extremely low friction/low wear
- Good for higher loads





Standard/thread



Overmold/thread

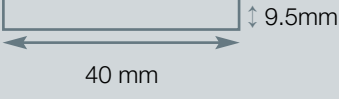
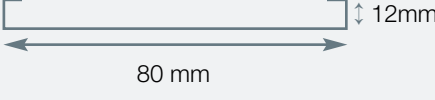

Online Lifetime
Calculation
www.igus.com

Dimensional Drawing	Maximum Load	Maximum Speed	Rail Material	Carriage Material
 <p>A rectangular rail with a length of 17 mm and a height of 6 mm. The dimensions are indicated by double-headed arrows and vertical arrows.</p>	<p>11 lbs (50 N)</p>	<p>49 fps (15 m/s)</p>	<p>Anodized Aluminum</p>	<p>Brass / Plastic</p>
 <p>A rectangular rail with a length of 27 mm and a height of 9.5 mm. The dimensions are indicated by double-headed arrows and vertical arrows.</p>	<p>110 - 168 lbs (490 - 750 N) Depending on the carriage</p>	<p>49 fps (15 m/s)</p>	<p>Anodized Aluminum</p>	<p>Chromated Zinc / Plastic or Brass / Plastic</p>
 <p>A rectangular rail with a length of 40 mm and a height of 9.5 mm. The dimensions are indicated by double-headed arrows and vertical arrows.</p>	<p>157 lbs (700 N)</p>	<p>49 fps (15 m/s)</p>	<p>Anodized Aluminum</p>	<p>Chromated Zinc / Plastic</p>
 <p>A rectangular rail with a length of 80 mm and a height of 12 mm. The dimensions are indicated by double-headed arrows and vertical arrows.</p>	<p>220 lbs (1000 N)</p>	<p>49 fps (15 m/s)</p>	<p>Anodized Aluminum</p>	<p>Chromated Zinc / Plastic Aluminum available</p>



DryLin® N Low Profile Linear Guide Systems

The DryLin® N series offers extremely low profiles in several widths, and is ideal in tight space constraints. Like all DryLin® products the carriages are designed to glide smoothly on anodized aluminum rails without the need for messy lubricants. DryLin® N is a particularly low-cost alternative to miniature ball bearing systems, and is more precise and economical when compared to many custom-machined or simple plastic parts.

Technical Data

Sliding elements:

Maintenance-free polymer

Material:

iglide® J*

Max. surface speed:

50 fps (15 m/s)

Temperature range:

-40°F to +194°F

(-40 °C to +90 °C)

* Other materials upon request

DryLin® N	Height
N17	.24 in (6.0 mm)
N27	.37 in (9.5 mm)
N40	.37 in (9.5 mm)
N80	.47 in (12.0 mm)

Special Features



Cleanroom certified - IPA Fraunhofer



ESD compatible (electrostatic discharge)



Free of toxins - RoHS 2002/95/EC

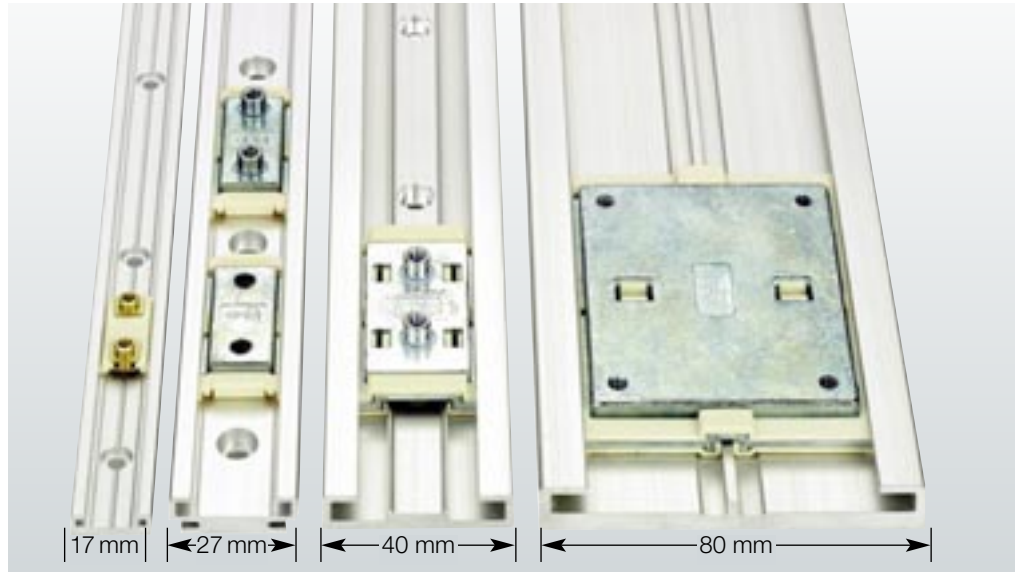

Advantages of DryLin® N

- Small mounting height and width
- Maintenance-free and self-lubricating
- Corrosion-resistant
- Low wear and low coefficient of friction
- Lightweight
- Very high speed and acceleration possible
- Replaceable polymer sliding elements
- Base structure of the carriage made of plastic (size 17) or zinc (size 27, 40 and 80)
- Anodized aluminum rails cut to length



DryLin® N80, black anodized used for adjusting spotlights



DryLin® N80 in a belt-driven linear actuator for high-speed handling up to 12 m/s

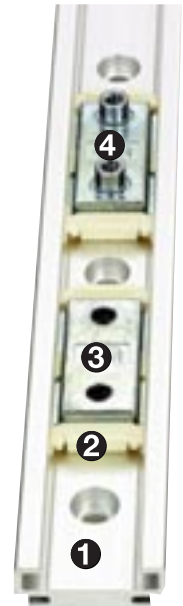

- 1 Anodized aluminum rails
- 2 iglide® J plain bearing liner
- 3 Zinc chromated carriage Type 01 (with mounting hole)
- 4 Zinc chromated carriage Type 02 (with thread)



Online Lifetime Calculation
www.igus.com

DryLin® N Low Profile Linear Guide Systems



Standard



Preload



Floating

DryLin® NW-17 = 17 mm Rail width

NW 17

The smallest size of the DryLin® N range is designed to fit in the tightest space constraints. In addition, this range is free from lubrication and can run at high speeds.

NW 17 Preload

The NW 17 Preload model of the DryLin® N series provides for an automatic pretension to the rail for reduced clearance.



Standard 01 with mounting hole



Standard 02 with thread



Preload with mounting hole or thread



Overmolded with mounting hole or thread

DryLin® NW-27 = 27 mm Rail width

NW 27

The NW 27 series is available in multiple carriage lengths and materials, and has great performance-to-cost benefits.

NW 27 Preload

Like NW 17 Preload, this larger NW 27 Preload model of DryLin® N possesses the special feature of automatic pre-tension.

Overmolded

This version is practically identical to the standard slide NW-01/02-27. Overmolded with iglide® J, however, it is easier to assemble for high volume production.

- Quick assembly
- Easier handling

Maximum loads (per carriage)

NW-02-17	=	11 lbs
NW-01/02-27	=	110 lbs
NW-02-40	=	154 lbs
NW-02-80	=	220 lbs



Standard 02 with thread



Overmolded with thread

DryLin® NW-40 = 40 mm Rail width

NW 40

Compared with smaller series, NW 40 is able to withstand significantly higher loads. Like all other DryLin® N series, the lubrication free design is capable of running at high linear speeds.



DryLin® NW-80 = 80 mm rail width

NW 80

The largest of the DryLin® N series permits low installation heights while offering high load-bearing capacity. The lubrication free design is capable of running at high linear speeds.

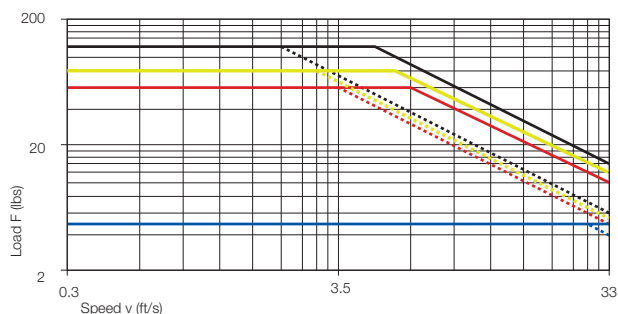

- dotted line: Size 17 z-direction
- dotted line: Size 27 z-direction
- dotted line: Size 40 z-direction
- dotted line: Size 80 z-direction
- Size 17
- Size 27
- Size 40
- Size 80

F = total of the loads on one rail

Graph 21.1: Fv-Diagram, maximum permissible dynamic loads of DryLin® N

DryLin® N
Linear Guide Systems

PDF: www.igus.com/iglide-pdfs
CAD: www.igus.com/iglide-CAD
RoHS info: www.igus.com/RoHS





DryLin® N Low Profile Linear Guide Systems

DryLin® N
Linear Guide Systems

Telephone 1-800-521-2747
1-401-438-7270
Fax

Internet: <http://www.igus.com>
email: sales@igus.com
QuickSpec: <http://www.igus.com/iglide-quickspec>

Eccentric Forces

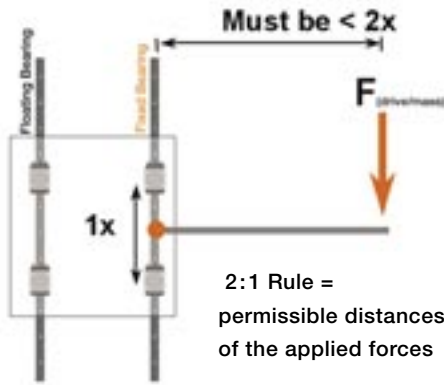

Online Lifetime Calculation
www.igus.com

The 2:1 Rule

When using linear plain bearings it is important to ensure that the acting forces follow the 2:1 Rule (see drawing). If either the load or the drive force (F) is greater than twice the bearing length (1X), then a binding or interrupted motion may occur.

If the location of the drive force or load cannot be changed, simply increase the distance between the bearings, or create a counterbalance to move the center-of-gravity back within the 2 to 1 ratio.

Fixed and Floating Bearing Mounting Instructions

When using systems with 2 parallel rails, one side must be designated as the “fixed” rail, and the opposite side the “floating” rail.

Why use floating bearings?

- promotes smooth gliding performance and maximizes bearing life
- prevents binding caused by parallelism and angle errors
- decreases necessary drive force and wear by minimizing friction-forces
- Enhances the precision of the system over the bearings' lifetime.
- Reduce assembly time and cost

Fixed Bearings

The “fixed” bearing rail should be positioned closest to the drive force. This rail will determine the precision of the system; no system should contain more than two “fixed” bearings.

Floating/Self-Aligning Bearings

The “floating” rail should be the rail located furthest from the drive force. It is to act only as a guide, and will compensate for any misalignments or angle errors in the system ensuring proper functionality.

Mounting Surfaces

The mounting surfaces for rails and bearings should have a very flat surface (e.g milled surface) in order to enhance performance. Variations in these surfaces may be compensated for by using floating bearings.

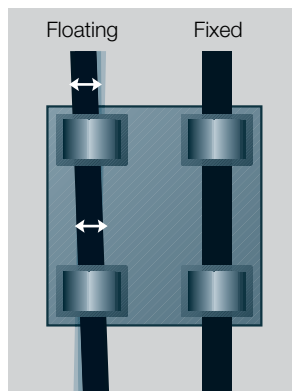

DryLin® N - Floating Systems

Maximum float = ± .02” (.5 mm)

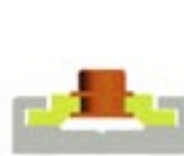

Standard Version

Part No.
Fixed Bearing -
CARRIAGE ONLY

- NW-02-17
- NW-02-27 / NW-02-27
- NW-02-40
- NW-02-80



Horizontal Float “LLZ”

Part No.
Horizontal Floating -
CARRIAGE ONLY

- NW-02-17 LLZ
- NW-01-27 LLZ
- NW-02-27 LLZ
- NW-02-40 LLZ
- NW-02-80 LLZ

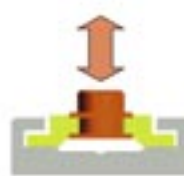

Vertical Float “LLY”

Part No.
Vertical Floating -
CARRIAGE ONLY

- NW-02-17 LLY
- NW-01-27 LLY
- NW-02-27 LLY
- NW-02-40 LLY
- NW-02-80 LLY



Vertical Float “LLYZ”

Part No.
Horizontal/Vertical Floating -
CARRIAGE ONLY

- NW-02-17 LLYZ
- NW-01-27 LLYZ
- NW-02-27 LLYZ
- NW-02-40 LLYZ
- NW-02-80 LLYZ

DryLin® N Low Profile Linear Guide Systems



Part No. for single carriages:

Carriages	Carriage/Bearing Material/Color	Mounting Style	Description	Max Static Load
NW-02-17	Plastic/Brass/iglide J/Yellow	Threaded brass boss	Standard	11 lbs (50N)
NW-02-17 P	Plastic/Brass/iglide J/Yellow	Threaded brass boss	Preloaded	11 lbs (50N)
NW-22-17-40	Plastic/Brass/iglide J/Yellow	Threaded brass boss	Overmolded, double-length version	11 lbs (50N)
NW-01-27	Chromated Zinc/iglide J/Yellow	Through holes	Standard, clip-on plastic	112 lbs (500N)
NW-01-27 P	Zinc/iglide J/Yellow	Through holes	Preloaded .22 lbs (1N)	112 lbs (500N)
NW-11-27	Zinc/iglide J/Yellow	Through holes	Overmolded plastic, with through holes	112 lbs (500N)
NW-11-27-SS	Stainless Steel/iglide J/Yellow	Through holes	Overmolded plastic, with through holes	168 lbs (750N)
NW-02-27	Zinc/iglide J/Yellow	Threaded bosses	Standard, clip-on plastic	112 lbs (500N)
NW-02-27 P	Zinc/iglide J/Yellow	Threaded bosses	Preloaded .22 lbs (1N)	112 lbs (500N)
NW-12-27	Zinc/iglide J/Yellow	Threaded bosses	Overmolded plastic, with through holes	112 lbs (500N)
NW-11-27-80	Zinc/iglide J200/Grey	Through holes	Overmolded, double-length version	167 lbs (740N)
NW-21-27-60P	Plastic/iglide J/Yellow	Brass through holes	50% longer, preloaded	112 lbs (500N)
NW-22-27-60P	Plastic/iglide J/Yellow	Brass threaded boss	50% longer, preloaded	112 lbs (500N)
NW-01-40	Chromated Zinc/iglide J/Yellow	Through holes	Standard. clip-on plastic	157 lbs (700N)
NW-02-40	Chromated Zinc/iglide J/Yellow	Threaded bosses	Standard. clip-on plastic	157 lbs (700N)
NW-12-40	Chromated Zinc/iglide J/Yellow	Threaded bosses	Overmolded plastic	157 lbs (700N)
NW-02-80	Chromated Zinc/iglide J/Yellow	Threaded, no bosses	Standard. clip-on plastic	225 lbs (1000N)
NW-12-80	Chromated Zinc/iglide J/Yellow	Threaded, no bosses	Overmolded	225 lbs (1000N)
NW-02-80AL	Aluminum/iglide J/Yellow	Threaded, no bosses	Standard. clip-on plastic	250 lbs (1111N)

Part No. for single rails:

Rail	Material	Description	Maximum Length
NS-01-17	6063-T6 Anodized AL	M3 Mounting holes	6.5 ft
NS-01-17S	6063-T6 Anodized AL	No holes	6.5 ft
NS-01-27	6063-T6 Anodized AL	M4 Mounting holes	12 ft (4000 mm special order)
NS-01-27S	6063-T6 Anodized AL	No holes	12 ft (4000 mm special order)
NS-01-40	6063-T6 Anodized AL	M4 Mounting holes	12 ft (4000 mm special order)
NS-01-40S	6063-T6 Anodized AL	No holes	12 ft (4000 mm special order)
NS-01-80	6063-T6 Anodized AL	M4 Mounting holes	12 ft (4000 mm special order)
NS-01-80S	6063-T6 Anodized AL	No holes	12 ft (4000 mm special order)

Structure of the Part No. for assembled systems:

NK -02 -27 -02 -500 LLZ C5=20

Assembled system

Type of carriage

- 01 with thru bore
- 02 with thread
- 11 with thru bore, overmolded, size 27
- 12 with thread, overmolded, size 27, 40

Size

17/27/40/80

No. of carriages

Length of rail in mm

Carriage options

- Leave blank: Standard
- LLZ: Floating z-direction
- LLY: Floating y-direction
- LLYZ: Floating y- and z-direction
- P: Preload (max. 1 N), only sizes 17/27

Rail options

- Leave blank: Standard with holes
- No holes: Without holes
- C5 = ... mm If hole spacing is not symmetrical

DryLin® N
Linear Guide Systems

PDF: www.igus.com/iglide-pdfs
CAD: www.igus.com/iglide-CAD
RoHS info: www.igus.com/RoHS





DryLin® N Low Profile Linear Guide Systems - NK-02-17

DryLin® N
Linear Guide Systems

Telephone 1-800-521-2747
1-401-438-7270
Fax

Internet: <http://www.igus.com>
email: sales@igus.com
QuickSpec: <http://www.igus.com/iglide-quickspec>



NW-02-17
Standard



NW-22-17-40
Double Length



NW-02-17P
Preloaded

Carriages	Carriage/Bearing Material/Color	Mounting Style	Description	Weight	Max Static Load
NW-02-17	Plastic/Brass/iglide J/Yellow	Threaded brass boss	Standard	.06 oz (1.7g)	11 lbs (50N)
NW-02-17P	Plastic/Brass/iglide J/Yellow	Threaded brass boss	Preloaded .23 lbs (1N)	.06 oz (1.7g)	11 lbs (50N)
NW-22-17-40	Plastic/Brass/iglide J/Yellow	Threaded brass boss	Overmolded, double-length version	.09 oz (2.6g)	11 lbs (50N)
-LLZ	for floating in Z-direction, best for horizontal applications for rail alignment				
-LLY	for floating in Y-direction, best for vertical applications or when flatness of the mounting surface is of concern				
-LLYZ	for floating in both directions				

Floating carriages (see page 21.6 about fixed and floating)

Rail	Material	Description	Weight	Hole Pattern	Max Length
NS-01-17	6063-T6 Anodized AL	M3 Mounting holes	0.1 lbs/ft (150 g/m)	Bore pattern symmetrical C%=C6	6.5 ft
NS-01-17S	6063-T6 Anodized AL	No holes	0.1 lbs/ft (150 g/m)	NA	12 ft

No cut charges for standard C5/C6 and overall length tolerances

NW-02-17(P)

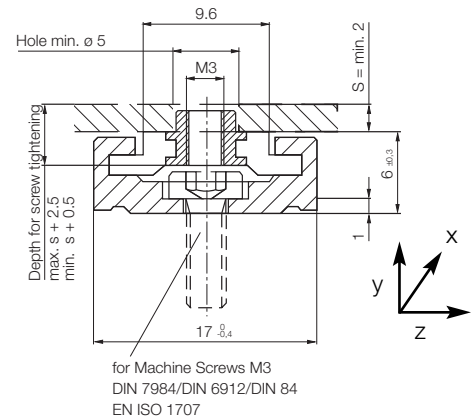
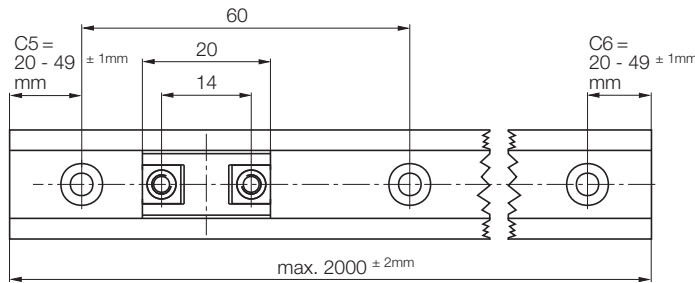

NW-22-17-40

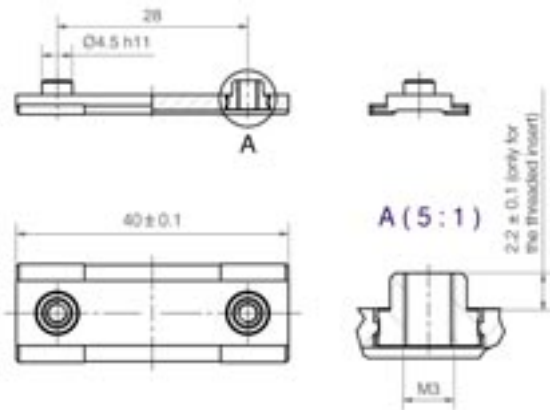

Static load-bearing capacity and geometric moment of inertia

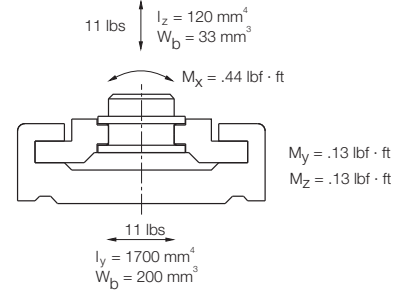

Structure of the Part No.

NK	-02	-17	P	-2	-500
----	-----	-----	---	----	------



CAD files online:
www.igus.com

DryLin® N Low Profile Linear Guide Systems

NK-01-27 / NK-02-27



NW-01-27(P)/NW-11-01 Carriages with through hole

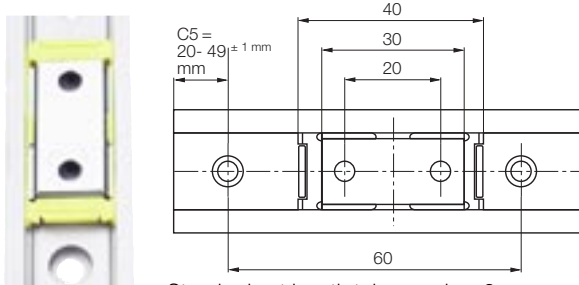

Standard cut length tolerance is ± 2 mm

NW-02-27(P)/NW-12-01 Carriages with threaded boss

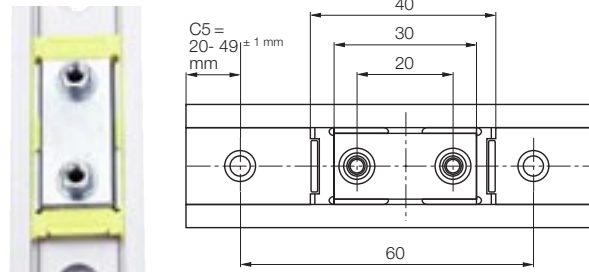

Standard cut length tolerance is ± 2 mm

Carriages	Carriage/Bearing Material/Color	Mounting Style	Description	Weight	Max Static Load
Standard					
NW-01-27	Chromated Zinc/iglide J/Yellow	Through holes	Standard, clip-on plastic	.38 oz (10.8g)	112 lbs (500N)
NW-02-27	Chromated Zinc/iglide J/Yellow	Threaded bosses	Standard, clip-on plastic	.44 oz (12.5g)	112 lbs (500N)
Overmolded					
NW-11-27	Chromated Zinc/iglide J/Yellow	Through holes	Overmolded plastic	.38 oz (10.8g)	112 lbs (500N)
NW-12-27	Chromated Zinc/iglide J/Yellow	Threaded bosses	Overmolded plastic	.44 oz (12.5g)	112 lbs (500N)
Preloaded					
NW-01-27P	Chromated Zinc/iglide J/Yellow	Through holes	Preloaded .22 lbs (1N), clip-on	.38 oz (10.8g)	112 lbs (500N)
NW-02-27P	Chromated Zinc/iglide J/Yellow	Threaded bosses	Preloaded .22 lbs (1N), clip-on	.44 oz (12.5g)	112 lbs (500N)

- LLZ for floating in Z-direction, best for horizontal applications for rail alignment
- LLY for floating in Y-direction, best for vertical applications or when flatness of the mounting surface is of concern
- LLYZ for floating in both directions

Floating carriages (see page 21.6 about fixed and floating)

Rail	Material	Description	Weight	Hole Pattern	Max Length
NS-01-27	6063-T6 Anodized AL	M4 Mounting holes	0.2 lbs/ft (290 g/m)	Bore pattern symmetrical C5=C6	3658 mm
NS-01-27S	6063-T6 Anodized AL	No holes	0.2 lbs/ft (290 g/m)	NA	3658 mm

No cut charges for standard C5/C6 and overall length tolerances

* Length of overmolded carriages version NW-11-27 and NW-12-27: 34 ± 0.7 mm

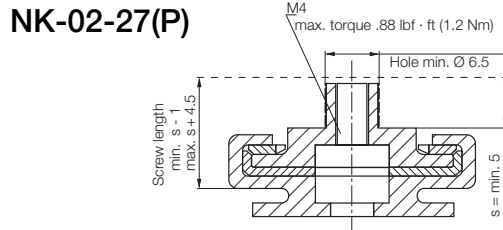
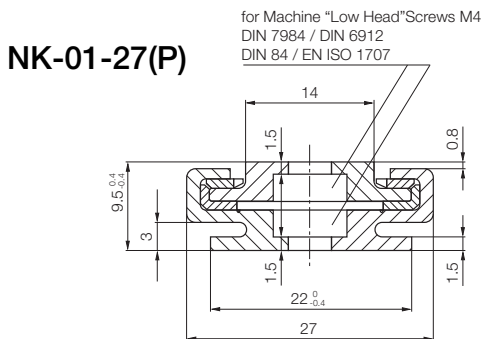

Static load-bearing capacity and geometric moment of inertia

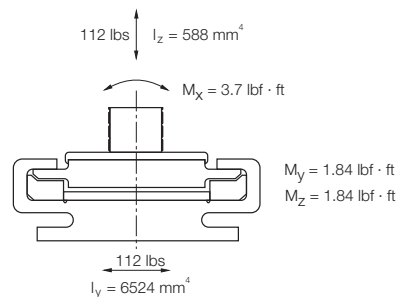
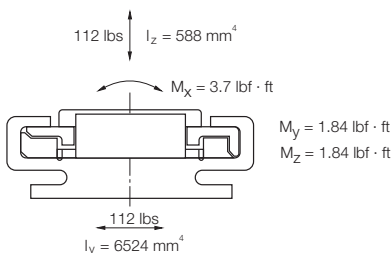



DryLin® N Low Profile Linear Guide Systems NW-11-27-80 Double Length Version

DryLin® N
Linear Guide Systems

Telephone 1-800-521-2747
1-401-438-7270
Fax

Internet: <http://www.igus.com>
email: sales@igus.com
QuickSpec: <http://www.igus.com/iglide-quickspec>

Carriages	Carriage/Bearing Material/Color	Mounting Style	Description	Weight	Max Static Load
NW-11-27-80	Chromated Zinc/iglide J200/Grey	Through holes	Overmolded, double length version	.80 oz (25g)	168 lbs (750N)

Rail	Material	Description	Weight	Hole Pattern	Max Length
NS-01-27	6063-T6 Anodized AL	M4 Mounting holes	0.2 lbs/ft (290 g/m)	Bore pattern symmetrical C5=C6	12 ft
NS-01-27S	6063-T6 Anodized AL	No holes	0.2 lbs/ft (290 g/m)	NA	12 ft

No cut charges for standard C5/C6 and overall length tolerances

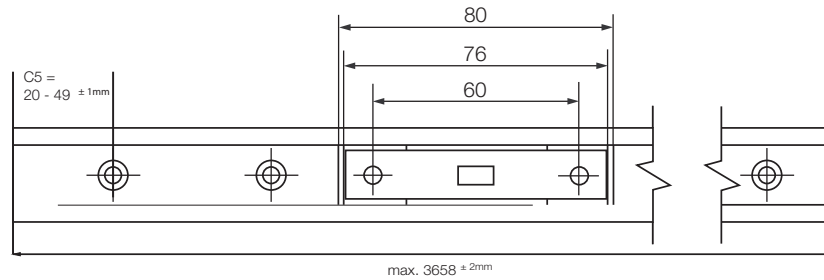

NK-04-27

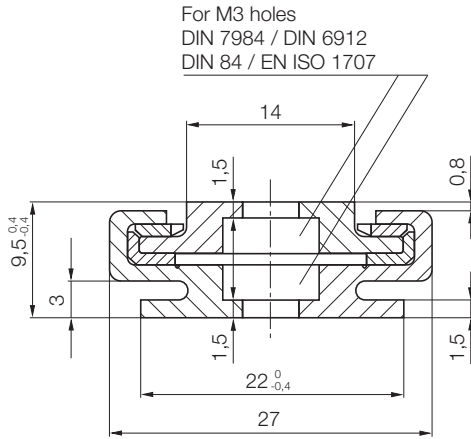

Static load-bearing capacity and geometric moment of inertia

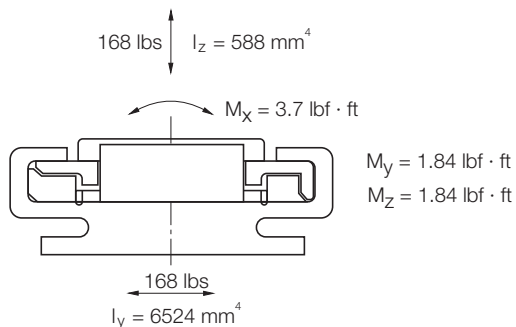

CAD files online:
www.igus.com

DryLin® N Low Profile Linear Guide Systems, Preloaded 50% longer than standard



NW-21-27-60-P



NW-22-27-60-P

Carriages	Carriage/Bearing Material/Color	Mounting Style	Description	Weight	Max Static Load
NW-21-27-60P	Plastic/iglide J/Yellow	Brass through holes	Preloaded	.29 oz (9g)	112 lbs (500N)
NW-22-27-60P	Plastic/iglide J/Yellow	Brass threaded boss	Preloaded	.39 oz (12g)	112 lbs (500N)

Rail	Material	Description	Weight	Hole Pattern	Max Length
NS-01-27	6063-T6 Anodized AL	M4 Mounting holes	0.2 lbs/ft (290 g/m)	Bore pattern symmetrical C5=C6	12 ft
NS-01-27S	6063-T6 Anodized AL	No holes	0.2 lbs/ft (290 g/m)	NA	12 ft

No cut charges for standard C5/C6 and overall length tolerances

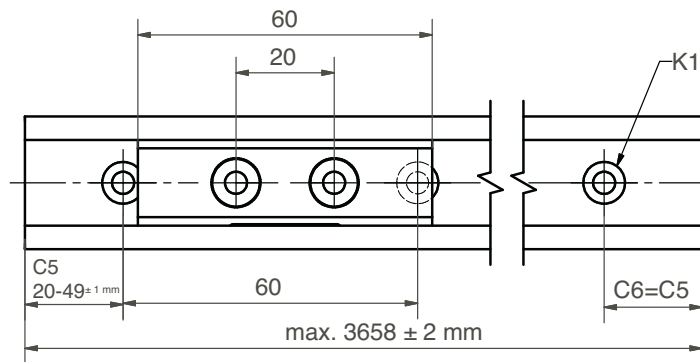

NW-21-27-60-P

NW-22-27-60-P

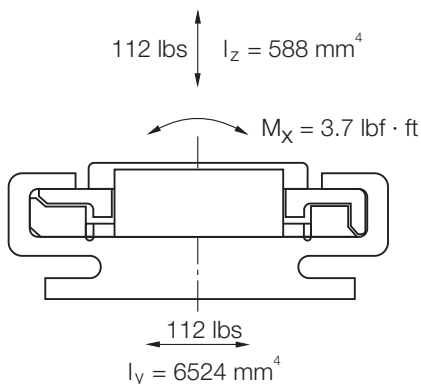
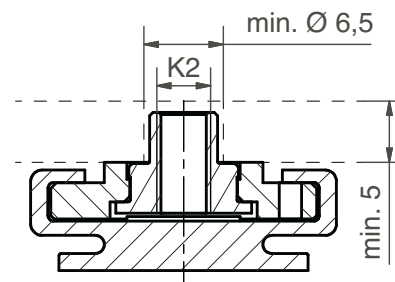
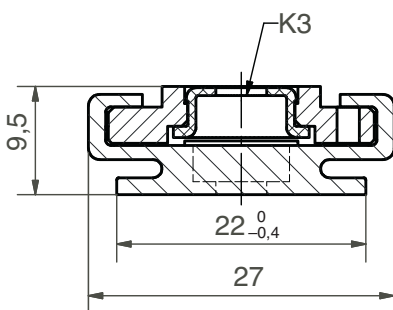

$M_y = 1.84 \text{ lbf} \cdot \text{ft}$
 $M_z = 1.84 \text{ lbf} \cdot \text{ft}$

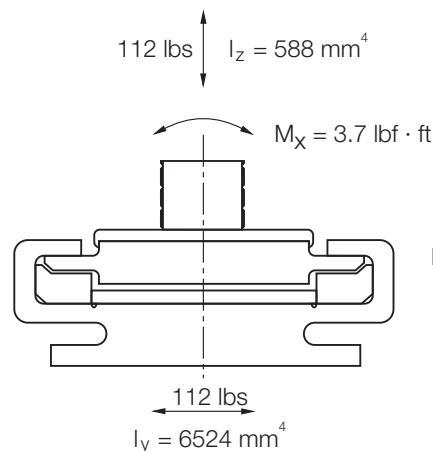

$M_y = 1.84 \text{ lbf} \cdot \text{ft}$
 $M_z = 1.84 \text{ lbf} \cdot \text{ft}$

PDF: www.igus.com/iglide-pdfs
 CAD: www.igus.com/iglide-CAD
 RoHS info: www.igus.com/RoHS





DryLin® N Low Profile Linear Guide Systems NW-01/02-40

DryLin® N
Linear Guide Systems

Telephone 1-800-521-2747
1-401-438-7270
Fax

Internet: <http://www.igus.com>
email: sales@igus.com
QuickSpec: <http://www.igus.com/iglide-quickspec>



NW-02-40



NW-01-40

Carriages	Carriage/Bearing Material/Color	Mounting Style	Description	Weight	Max Static Load
NW-01-40	Chromated Zinc/iglide J/Yellow	Through holes	Standard, clip-on plastic	1.06 oz (30g)	157 lbs (700N)
NW-02-40	Chromated Zinc/iglide J/Yellow	Threaded bosses	Standard, clip-on plastic	1.06 oz (30g)	157 lbs (700N)
NW-12-40	Chromated Zinc/iglide J/Yellow	Threaded bosses	Overmolded plastic	1.06 oz (30g)	157 lbs (700N)
-LLZ	for floating in Z-direction, best for horizontal applications for rail alignment				
-LLY	for floating in Y-direction, best for vertical applications or when flatness of the mounting surface is of concern				
-LLYZ	for floating in both directions				

Rail	Material	Description	Weight	Hole Pattern	Max Length
NS-01-40	6063-T6 Anodized AL	M4 Mounting holes	0.3 lbs/ft (450 g/m)	Bore pattern symmetrical C5=C6	12 ft
NS-01-40S	6063-T6 Anodized AL	No holes	0.3 lbs/ft (450 g/m)	NA	12 ft

No cut charges for standard C5/C6 and overall length tolerances

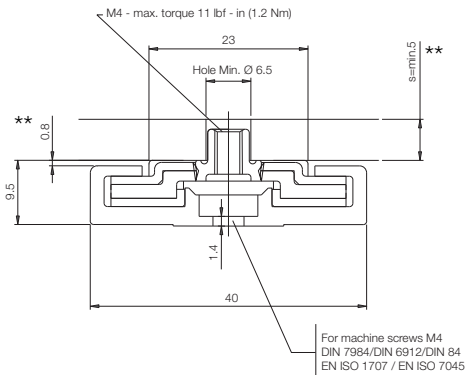
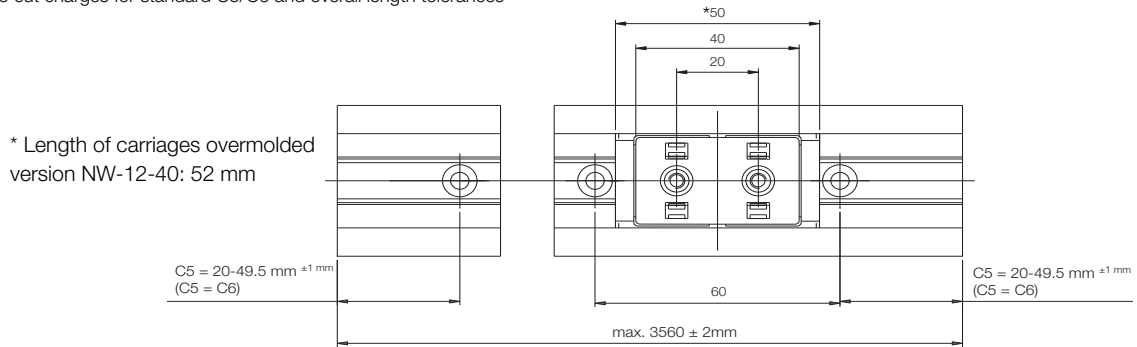

** For NW-02-40 only

Static load-bearing capacity and geometric moment of inertia

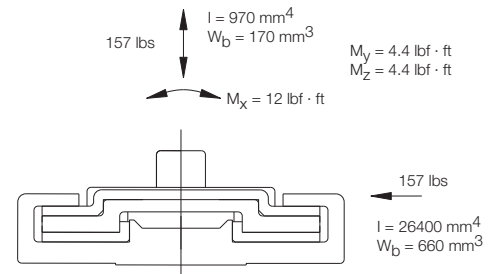

DryLin® NK – Complete system

Structure of the Part No. – Standard version

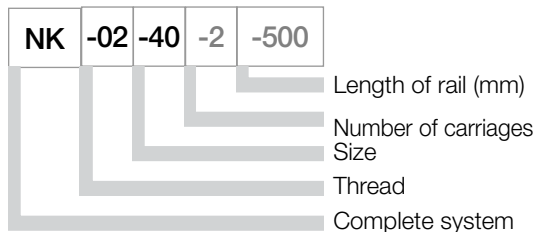

Option:

Polymer End cap for rail,
Part No. NSK-40





Carriages	Carriage/Bearing Material/Color	Mounting Style	Description	Weight	Max Static Load
NW-02-80	Chromated Zinc/iglide J/Yellow	Threaded no bosses	Standard, clip-on plastic	3.53 oz (100g)	225 lbs (1000N)
NW-12-80	Chromated Zinc/iglide J200/Grey	Threaded no bosses	Overmolded	3.53 oz (100g)	225 lbs (1000N)
NW-02-80AL	Aluminum/iglide J/Yellow	Threaded no bosses	Aluminum, clip-on plastic	2.56 oz (72g)	250 lbs (1111N)

Rail	Material	Description	Weight	Hole Pattern	Max Length
NS-01-80	6063-T6 Anodized AL	M4 Mounting holes	0.3 lbs/ft (450 g/m)	Bore pattern symmetrical C5=C6	12 ft
NS-01-80S	6063-T6 Anodized AL	No holes	0.3 lbs/ft (450 g/m)	NA	12 ft

No cut charges for standard C5/C6 and overall length tolerances

* carriage length for overmolded NW-12-80 = 83 mm
 ** size 45 on request

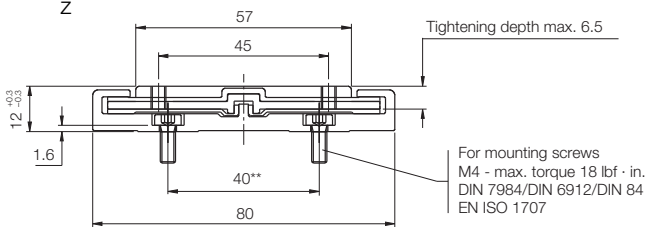
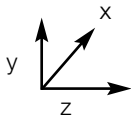
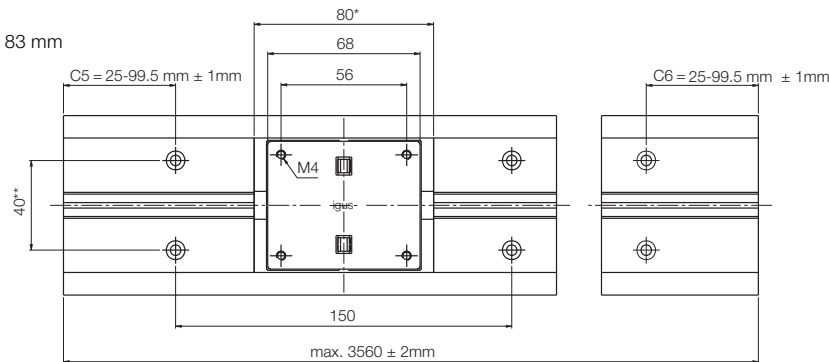

Static load-bearing capacity and geometric moment of inertia

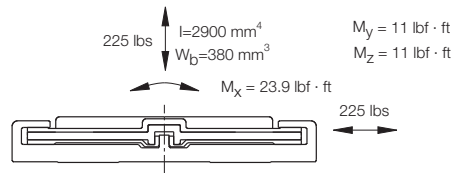

Structure of the Part No. – Standard version

NK -02 -40 -2 -500 -LLZ

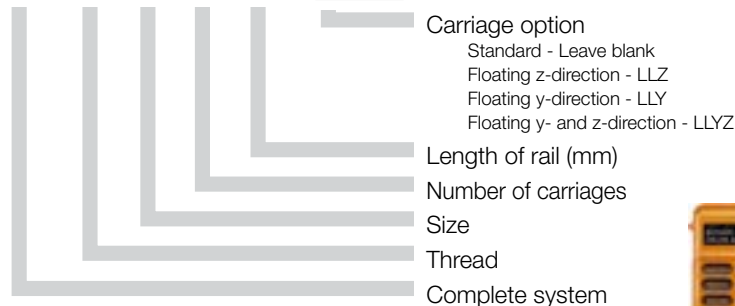

Online Lifetime Calculation
www.igus.com





DryLin® N Low Profile Linear Guide Systems

DryLin® N
Linear Guide Systems

Telephone 1-800-521-2747
Fax 1-401-438-7270

Internet: <http://www.igus.com>
email: sales@igus.com
QuickSpec: <http://www.igus.com/iglide-quickspec>

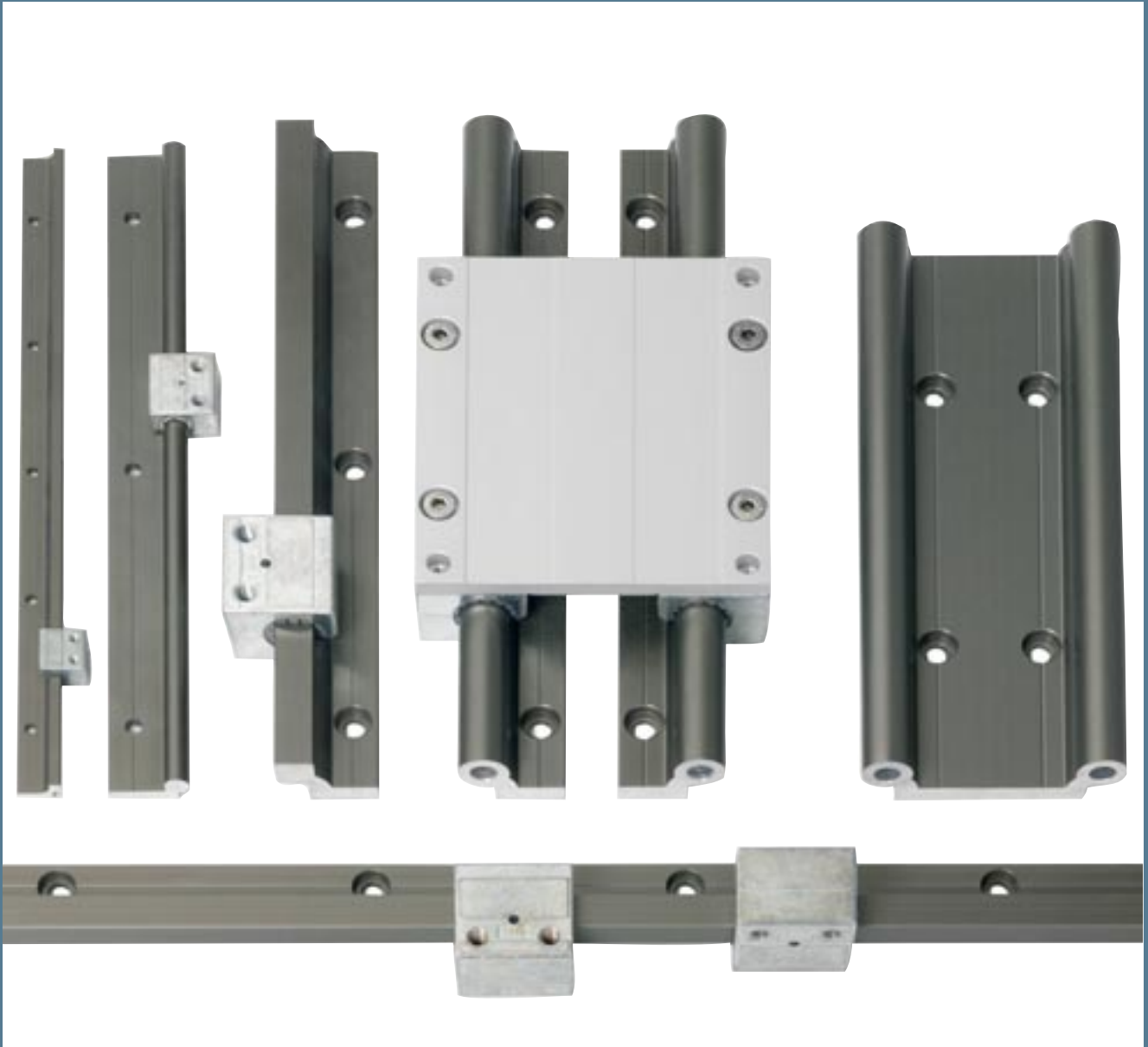

DryLin[®] W Linear Guide Systems

DryLin® W Selection Guide



DryLin® W06

- 06 mm bearing
- Small size for design constraints
- Flexible
- J200 liner for reduced friction
- Great for manual and motor driven applications
- Square design for optimal floating option

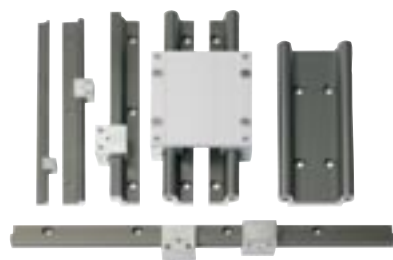

DryLin® W10

- 10 mm bearing
- Available in the most configurations
- Round standard with iglide® J material
- Square standard with iglide® J200 material
- Use square style as floating bearings
- Round style is excellent in aggressive environments



DryLin® W16

- 16 mm bearing
- All use the enhanced iglide® J200 liner
- Available square rail for optimal floating feature
- Also available in round profile
- Durable size

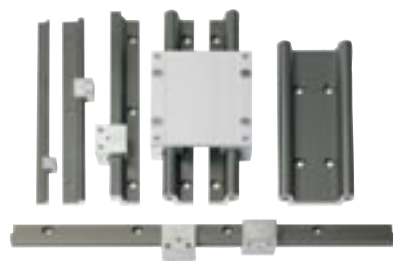

DryLin® W20

- 20 mm bearing
- Robust size
- All use the iglide® J200 liner for reduced friction and wear
- Available in both round and square profiles

Temperature	Maximum Load	
-40°F to +194°F (-40°C to +90°C)	94 lbs	
-40°F to +194°F (-40°C to +90°C)	Single Carriage 270 lbs	
-148°F to 482°F (stainless)	Mounted System 1079 lbs	
-40°F to +194°F (-40°C to +90°C)	Single Carriage 462 lbs	
	Mounted System 1848 lbs	
-40°F to +194°F (-40°C to +90°C)	Single Carriage 719 lbs	
-148°F to 482°F (stainless)	Mounted System 2876 lbs	





DryLin® W Linear Guide System

DryLin® W was developed to promote both design flexibility and quick assembly in both single and double rail configurations. DryLin® W is also available in several mounted assemblies eliminating the need for both shaft alignment and bearing assembly. All DryLin® W systems are available with our enhanced J200 liners, which reduce friction and optimize bearing life.

Technical Data

Sliding elements:

- Maintenance-free
- iglide® J / J200
- iglide® T500 (SS only)

Max. surface speed:

49 f/s (15 m/s)

Temperature range:

- 40°F to +194°F
- (-40°C to +90°C)

Rail:

- Hard anodized aluminum
- Optional 316 stainless

Carriages:

- Chromated Zinc
- Anodized aluminum
- Optional 316 Stainless



DryLin® W - The original flexible guiding systems

DryLin® W uses iglide® J200 liners similar to DryLin® R but is also offered as cost-effective, harnessed systems. The design of DryLin® W promotes flexibility of design, and ease of assembly, with both single and double rail configurations:

- The single rail system, which may incorporate a floating square bearing, efficiently compensates for extreme shaft misalignments.
- The double rail system eliminates altogether the need for shaft alignment, offering a single bolt-on solution.

Hard anodized aluminum is used as the rail material, therefore DryLin® W also offers low wear, low friction without lubrication, resistance to dirt and dust, low weight and quiet operation.



Also available as pre-assembled driven systems



SLW
Page
30.10



ZLW
Page
30.34



DryLin® W used for a stop dog in the glass industry



DryLin® W in permanent use in a conveyor belt



DryLin® W for guiding the igus® EnergyChain® in an inkjet printer

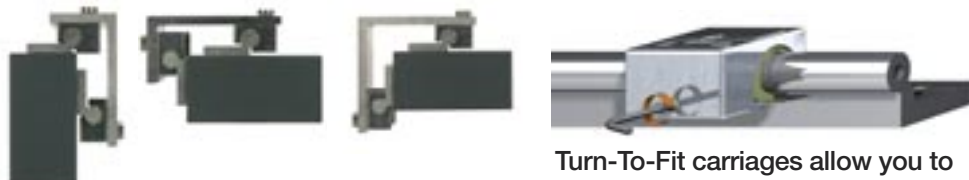

Turn-To-Fit carriages allow you to adjust the clearance for your application



DryLin® W Linear Guide Systems

Telephone 1-800-521-2747
Fax 1-401-438-7270

Internet: <http://www.igus.com>
email: sales@igus.com
QuickSpec: <http://www.igus.com/iglide-quickspec>



DryLin® W Single Rail – Square

Due to their geometry the square rails offer enhanced life-time as the bearing surface area is larger than the round bearings. They also allow better compensation for shaft misalignments and angle errors, as well as are ideal to compensate for poor tolerances, mounting surfaces. Rails are hard-anodized aluminum, bearings are zinc (optional hard-anodized aluminum), and the bearing materials are iglide® J200 and iglide® J, depending on the series.



DryLin® W Single Rail – Round

The round series offers the most options, such as WJUME bearings with adjustable clearance, WJRM rolling hybrid bearings, as well as manually-locking hand clamps. This series is particularly well suited for dirty, dusty application.



DryLin® W Double Rail

This series reduces assembly time by eliminating shaft alignment. They also offer high torque support and torsional rigidity. This series also offers the most options, such as WJUME bearings with adjustable clearance, WJRM rolling hybrid bearings, as well as manually-locking hand clamps.



DryLin® W Complete Carriage

Pre-assembled bearing carriages are available to reduce assembly time and purchasing costs.



DryLin® W Stainless Steel

For the ultimate corrosion-resistant linear guide series our plastic linear bearings are coupled with 316-Series stainless.



DryLin® Specialists

WJUME - Adjustable, allows radial clearance adjustment by the use of a simple allen key.
 WJRM - Rolling hybrid with reduced for hand powered and very low cycle applications.

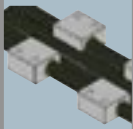

DryLin® W Linear Guide Systems

Telephone 1-800-521-2747
Fax 1-401-438-7270

Internet: <http://www.igus.com>
email: sales@igus.com
QuickSpec: <http://www.igus.com/iglide-quickspec>



iglide® J (Standard in 10mm round only)



iglide® J200 Square



iglide® J200 Round

iglide® J200 – various shaft materials

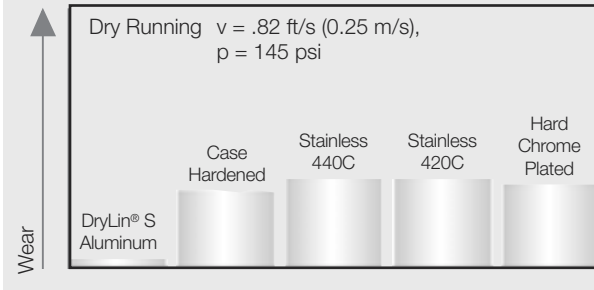

The iglide® J200 material

iglide® J200 material is especially developed for hard anodized aluminum surfaces. Comprehensive laboratory tests showed that iglide® J200 is by far the most suitable polymer material for linear motion applications on aluminum rails. iglide® J200 is 3 times as abrasion resistant on anodized aluminum than hardened steel. Special Characteristics of iglide® J200:

- Extreme durability using anodized aluminum
- Low abrasion using anodized aluminum
- Excellent wear resistance using anodized aluminum
- Maintenance free

iglide® J200 is standard on all DryLin® W products using hard anodized aluminum rail.

DryLin® W Mounting Instructions

For Parts WJ-

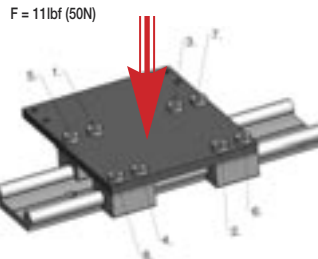
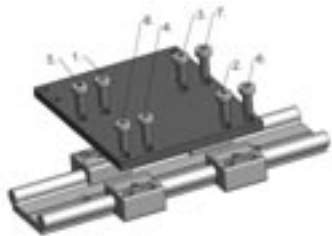

For Parts WK-

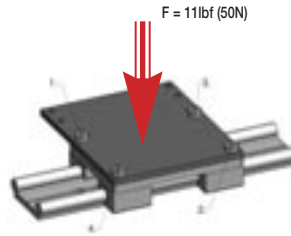
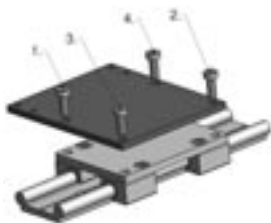

A thrust force of at least 11lbs (50N) applied to the center of the assembly is recommended during the mounting process.

Fastener/Torque

- W-06: M4 = 13.27 lbf · in (1.5 Nm)
- W-10: M6 = 53 lbf · in (6 Nm)
- W-16: M8 = 133 lbf · in (15 Nm)
- W-20: M8 = 133 lbf · in (15 Nm)

DryLin® W Linear Guide Systems

Technical Information



Type	Carriage Length		Carriage Width		Coy		Coz		Mox		Moy		Moz	
	(in.)	mm	(in.)	mm	(lbs)	N	(lbs)	N	(lbf · ft)	Nm	(lbf · ft)	Nm	(lbf · ft)	Nm
WW-06-30-06	(2.36)	60	(2.13)	54	(377)	1680	(377)	1680	(18)	25	(25)	34	(25)	34
WW-06-30-08	(3.15)	80	(2.13)	54	(377)	1680	(377)	1680	(18)	25	(37)	51	(37)	51
WW-06-30-10	(3.94)	100	(2.13)	54	(377)	1680	(377)	1680	(18)	25	(50)	68	(50)	68
WW-10-40-10	(3.94)	100	(2.87)	73	(1079)	4800	(1079)	4800	(70)	96	(125)	170	(125)	170
WW-10-40-15	(5.91)	150	(2.87)	73	(1079)	4800	(1079)	4800	(70)	96	(213)	290	(213)	290
WW-10-40-20	(7.87)	200	(2.87)	73	(1079)	4800	(1079)	4800	(70)	96	(302)	410	(302)	410
WW-10-80-10	(3.94)	100	(4.21)	107	(1079)	4800	(1079)	4800	(131)	178	(125)	170	(125)	170
WW-10-80-15	(5.91)	150	(4.21)	107	(1079)	4800	(1079)	4800	(131)	178	(213)	290	(213)	290
WW-10-80-20	(7.87)	200	(4.21)	107	(1079)	4800	(1079)	4800	(131)	178	(302)	410	(302)	410
WW-16-60-10	(3.94)	100	(4.09)	104	(1888)	8400	(1888)	8400	(177)	240	(199)	270	(199)	270
WW-16-60-15	(5.91)	150	(4.90)	104	(1888)	8400	(1888)	8400	(177)	240	(354)	480	(354)	480
WW-16-60-20	(7.87)	200	(4.09)	104	(1888)	8400	(1888)	8400	(177)	240	(509)	690	(509)	690
WW-20-80-15	(5.91)	150	(5.20)	134	(2877)	12800	(2877)	12800	(387)	525	(434)	670	(434)	670
WW-20-80-20	(7.87)	200	(5.20)	134	(2877)	12800	(2877)	12800	(387)	525	(730)	990	(730)	990
WW-20-80-25	(9.84)	250	(5.20)	134	(2877)	12800	(2877)	12800	(387)	525	(922)	1250	(922)	1250

Load capacities for complete carriage plates

DryLin® W – Rail Systems

	Size 6 (mm)	Size 10 (mm)	Size 16 (mm)	Size 20 (mm)
Single Rail – Round		●	●	●
Single Rail – Square	●	●	●	●
Double Rail	●	● ●	●	●
Linear Guide System	●	●	●	●

¹ Square double profile
² Width double rails (mm)

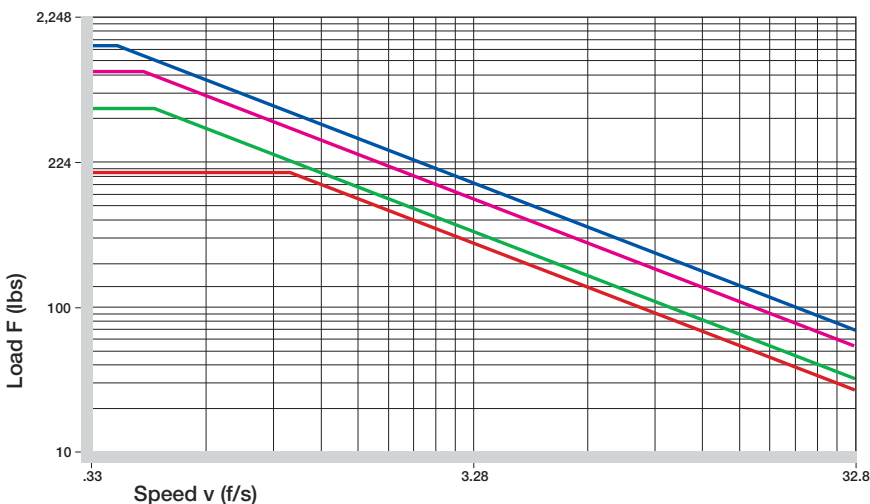
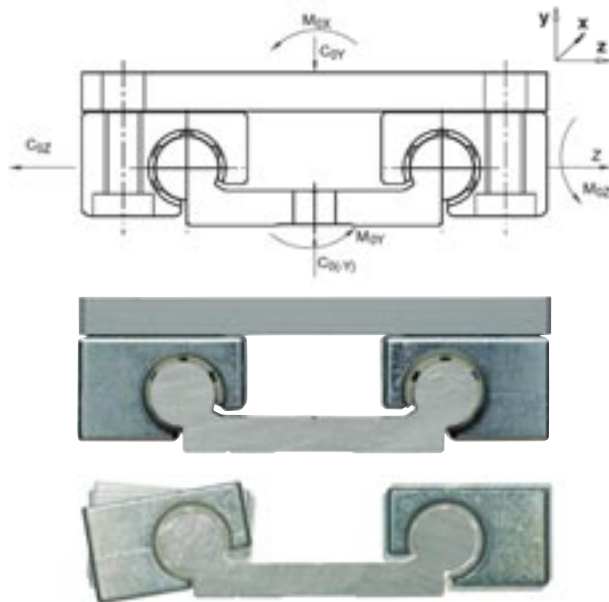

F x V Diagram, maximum permissible dynamic loads (4 bearing system)

DryLin® W Linear Guide Systems

PDF: www.igus.com/iglide-pdfs
 CAD: www.igus.com/iglide-CAD
 RoHS info: www.igus.com/RoHS





DryLin® W Linear Guide Systems - Design Notes

DryLin® W Linear Guide Systems

Telephone 1-800-521-2747
Fax 1-401-438-7270

Internet: <http://www.igus.com>
email: sales@igus.com
QuickSpec: <http://www.igus.com/iglide-quickspec>



Floating bearings for all directions compensate misalignments and parallelism errors

Floating bearings facilitate assembly – only necessary for individual rails.

Assembly is easy with the DryLin® WQ square profile. Floating bearings for all directions (± 1 mm) compensate for misalignments and parallelism errors between rails. This includes jamming, otherwise only prevented by time-consuming parallel alignment of the system.

Although DryLin® W is a profile rail system, it is able to compensate angular rotation errors about the x-axis. An angular adjustment of $\pm 7^\circ$ is possible. This effectively eliminates the problems known to occur when fitting to sheet metal.

System Assembling: Rails

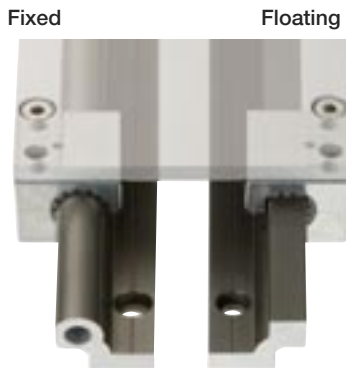
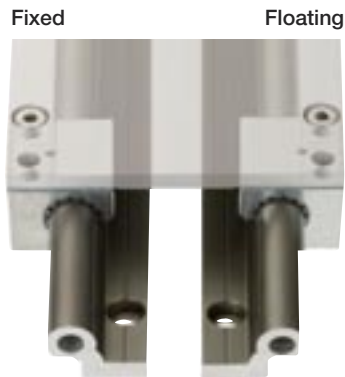

Available floating bearing blocks

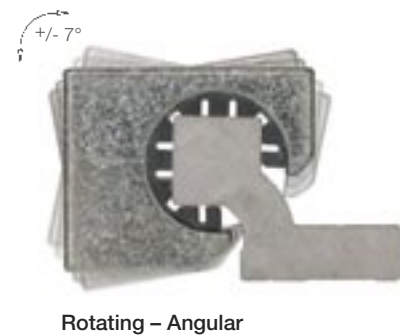
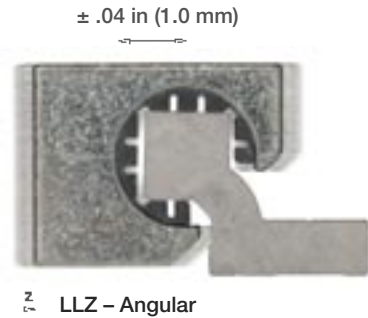
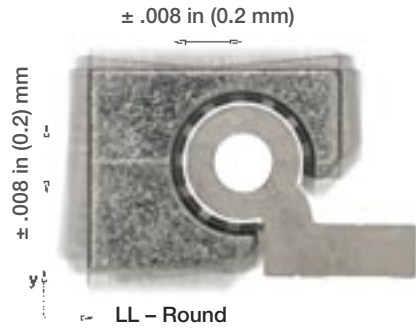

Rotating - Angular



When using systems with 2 parallel rails, one side must be designated as the “fixed” rail, and the opposite side as the “floating” rail.

Why use floating bearings?

- promotes smooth gliding performance and maximizes bearing life
- prevents binding caused by parallelism and angle errors
- decreases necessary drive force and wear by minimizing friction-forces
- Enhances the precision of the system over the bearings' lifetime.
- Reduce assembly time and cost

Fixed Bearings

The “fixed” bearing rail should be positioned closest to the drive force. This rail will determine the precision of the system; no system should contain more than two “fixed” bearings.

Floating/Self-Aligning Bearings

The “floating” rail should be the rail located furthest from the drive force. It is to act only as a guide, and will compensate for any misalignments or angle errors in the system ensuring proper functionality.

Mounting Surfaces

The mounting surfaces for rails and bearings should have a very flat surface (e.g milled surface) in order to enhance performance. Variations in these surfaces may be compensated for by using floating bearings.

Eccentric Forces — The 2:1 Rule

When using linear plain bearings it is important to ensure that the acting forces follow the 2:1 Rule (see drawing). If either the load or the drive force (F) is greater than twice the bearing length (1X), then a binding or interrupted motion may occur.

If the location of the drive force or load cannot be changed, simply increase the distance between the bearings, or create a counter-balance to move the center-of-gravity back within the 2 to 1 ratio.

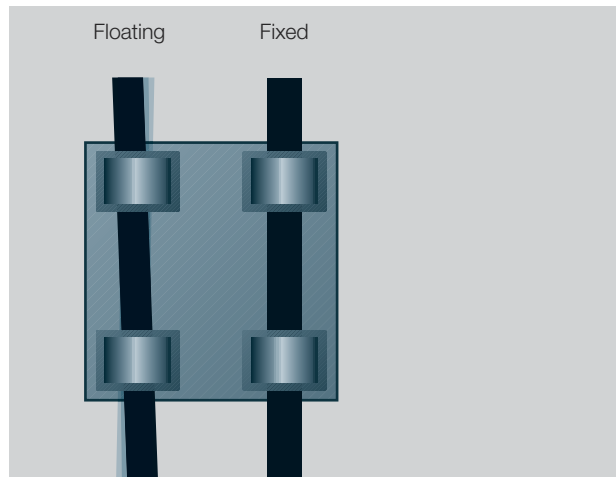

Automatic compensation of parallelism errors

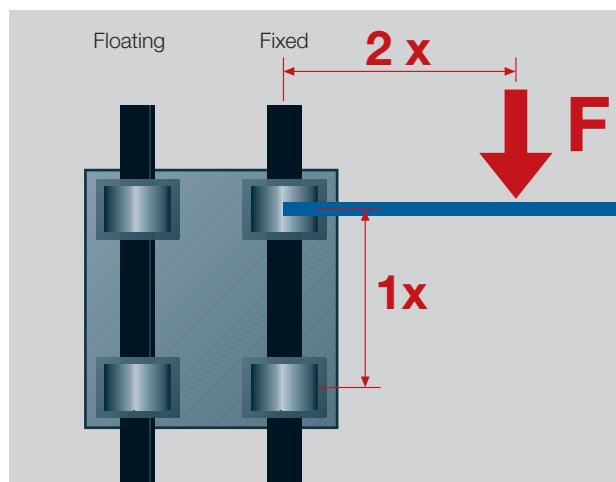

The 2:1 Rule





DryLin® W Linear Guide Systems Single Rail and Bearing Block - Square

DryLin® W Linear
Guide Systems

Telephone 1-800-521-2747
Fax 1-401-438-7270



Rail

Bearing block
Zinc, hard anodized
aluminum and 316
stainless steel option

- No cut charges for standard C5/C6 and overall length tolerances

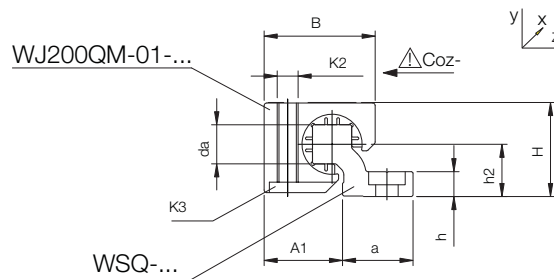
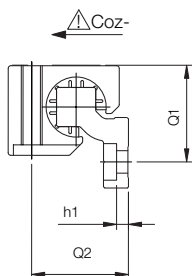
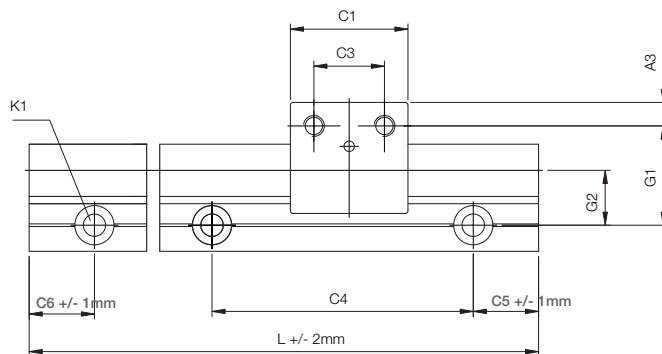

DryLin® W guide rails – Square

Part No.	Weight (kg/m)	H ±0.07 (mm)	da -0.1 (mm)	L Max. (mm)	a -0.3 (mm)	h	h1 (mm)	h2 (mm)	G1 (mm)	G2 (mm)	A1 (mm)	Q1 (mm)	Q2 (mm)
WSQ-06	0.23	14	5	3000	14	4	4*	7.5	18	10.5	13.5	17	15
WSQ-10	0.54	20	7.5	4000	25	5.5	5.5*	11	27	17	18.5	26	21
WSQ-16	0.94	27	11.5	4000	27	7.5	3.5	14	33	19	25	32	28
WSQ-20	1.41	36	15	4000	27	9.5	4.5	20	38	21	30	37	37

Part No.	C4 (mm)	C5 Min. (mm)	C5 Max. (mm)	C6 Min. (mm)	C6 Max. (mm)	K1 for screw DIN 912	ly (mm²)	lz (mm²)	Wby (mm³)	Wbz (mm³)
WSQ-06	60	20	49.5	20	49.5	M4*	2200	640	220	100
WSQ-10	120	20	79.5	20	79.5	M6*	16100	3300	950	350
WSQ-16	120	20	79.5	20	79.5	M8	33000	10800	1700	910
WSQ-20	120	20	79.5	20	79.5	M8	56500	34000	2600	2100

Standard bore pattern symmetrical: C5 = C6; please order C5 ≠ C6 with drawing

* Through hole

Internet: <http://www.igus.com>
email: sales@igus.com
QuickSpec: <http://www.igus.com/iglide-quickspec>

DryLin® W Linear Guide Systems

Single Rail and Bearing Block - Square

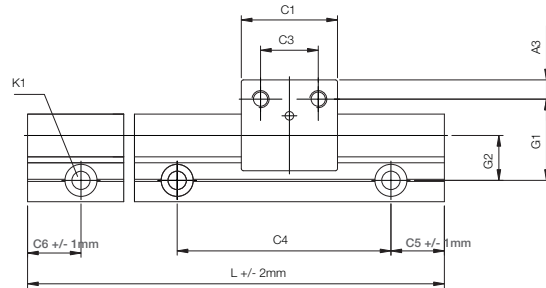
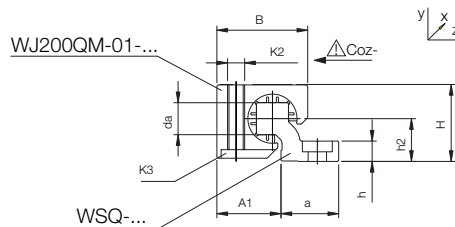
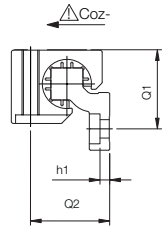

Part No.	Floating bearing play	Weight (g)	B (mm)	C1 (mm)	C3 (mm)	A3 (mm)	K2 (mm)	K3 (mm)	Static load capacity		
									Coy lbf (N)	Coz+ lbf (N)	Coz- lbf (N)

Zinc Block

WJ200QM-01-06	-	16	18	19	10	4.5	M4	M3	94 (420)	94 (420)	31 (140)
WJ200QM-01-10	-	41	26	29	16	6.5	M6	M5	270 (1200)	270 (1200)	56 (250)
WJ200QM-01-16	-	100	34.5	36	18	9	M8	M6	472 (2100)	472 (2100)	89 (400)
WJ200QM-01-20	-	190	42.5	45	27	9	M8	M6	719 (3200)	719 (3200)	112 (500)

Floating Z-Direction

WJ200QM0106LLZ	± 0.5	16	18	19	10	4.5	M4	M3	94 (420)	94 (420)	31 (140)
WJ200QM0110LLZ	± 0.7	41	26	29	16	6.5	M6	M5	270 (1200)	270 (1200)	56 (250)
WJ200QM0116LLZ	± 1.0	100	34.5	36	18	9	M8	M6	472 (2100)	472 (2100)	89 (400)
WJ200QM0120LLZ	± 1.0	190	42.5	45	27	9	M8	M6	719 (3200)	719 (3200)	112 (500)

Floating Y-Direction

WJ200QM0106LLY	± 0.5	16	18	19	10	4.5	M4	M3	94 (420)	94 (420)	31 (140)
WJ200QM0110LLY	± 0.7	41	26	29	16	6.5	M6	M5	270 (1200)	270 (1200)	56 (250)
WJ200QM0116LLY	± 1.0	100	34.5	36	18	9	M8	M6	472 (2100)	472 (2100)	89 (400)
WJ200QM0120LLY	± 1.0	190	42.5	45	27	9	M8	M6	719 (3200)	719 (3200)	112 (500)

Aluminum Block

WJ200QM0106AL	-	7	18	19	10	4.5	M4	M3	94 (420)	94 (420)	31 (140)
WJ200QM0110AL	-	20	26	29	16	6.5	M6	M5	270 (1200)	270 (1200)	56 (250)
WJ200QM0116AL	-	47	34.5	36	18	9	M8	M6	472 (2100)	472 (2100)	89 (400)
WJ200QM0120AL	-	94	42.5	45	27	9	M8	M6	719 (3200)	719 (3200)	112 (500)

Floating Z-Direction

WJ200QM0106ALZ	± 0.5	16	18	19	10	4.5	M4	M3	94 (420)	94 (420)	31 (140)
WJ200QM0110ALZ	± 0.7	41	26	29	16	6.5	M6	M5	270 (1200)	270 (1200)	56 (250)
WJ200QM0116ALZ	± 1.0	100	34.5	36	18	9	M8	M6	472 (2100)	472 (2100)	89 (400)
WJ200QM0120ALZ	± 1.0	190	42.5	45	27	9	M8	M6	719 (3200)	719 (3200)	112 (500)

Floating Y-Direction

WJ200QM0106ALY	± 0.5	16	18	19	10	4.5	M4	M3	94 (420)	94 (420)	31 (140)
WJ200QM0110ALY	± 0.7	41	26	29	16	6.5	M6	M5	270 (1200)	270 (1200)	56 (250)
WJ200QM0116ALY	± 1.0	100	34.5	36	18	9	M8	M6	472 (2100)	472 (2100)	89 (400)
WJ200QM0120ALY	± 1.0	190	42.5	45	27	9	M8	M6	719 (3200)	719 (3200)	112 (500)

DryLin® W Linear Guide Systems

PDF: www.igus.com/iglide-pdfs
 CAD: www.igus.com/iglide-CAD
 RoHS info: www.igus.com/RoHS



mm



DryLin® W Linear Guide Systems Single Rail and Bearing Block - Round

DryLin® W Linear
Guide Systems

Telephone 1-800-521-2747
Fax 1-401-438-7270

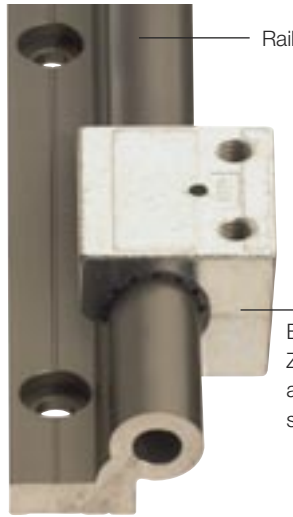

Rail

Bearing block
Zinc, hard anodized
aluminum and 316
stainless steel option

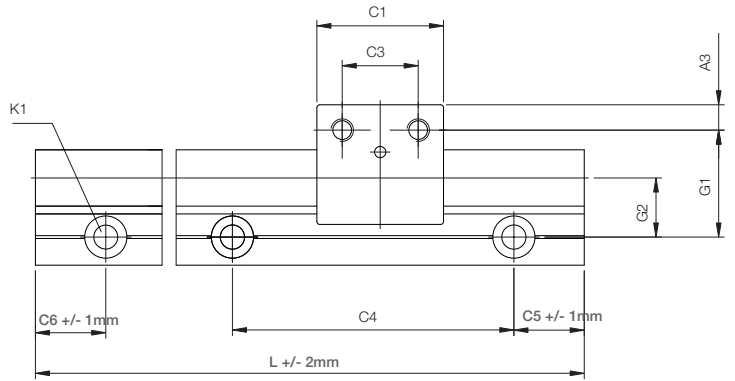

This bearing block
orientation is not
possible for WS-10.
Use square WSQ-10

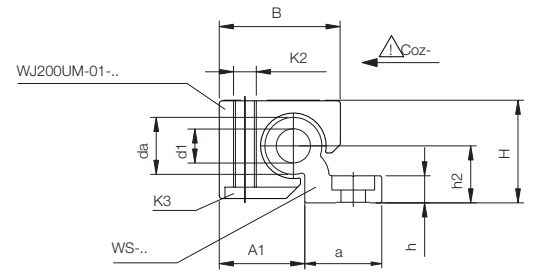
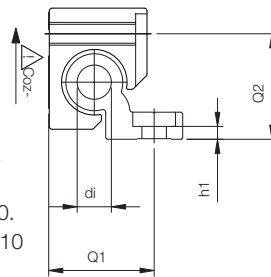

DryLin® W guide rails – Round

Part No.	Weight (kg/m)	H ±0.07 (mm)	da -0.1 (mm)	di (mm)	L Max. (mm)	a -0.3 (mm)	h (mm)	h1 (mm)	h2 (mm)	G1 (mm)	G2 (mm)	A1 (mm)	Q1 (mm)	Q2 (mm)
WS-10	0.62	18	10	-	4000	27	5.5	5.5**	9	27	17	16.5	-	-
WS-16	0.98	27	16	8.0	4000	27	7.5	3.5	14	33	19	25	32	28
WS-20	1.32	36	20	10.2	4000	27	9.5	4.5	20	38	21	30	37	37

Part No.	C4 (mm)	C5 Min. (mm)	C5 Max. (mm)	C6 Min. (mm)	C6 Max. (mm)	K1 for screw DIN 912	ly (mm²)	lz (mm²)	Wby (mm³)	Wbz (mm³)
WS-10	120	20	79.5	20	79.5	M6**	19000	2850	1000	310
WS-16	120	20	79.5	20	79.5	M8	36000	12900	1800	940
WS-20	120	20	79.5	20	79.5	M8	57100	35000	2700	1900

Standard bore pattern symmetrical: C5 = C6; please order C5 ≠ C6 with drawing

** Through hole

Internet: <http://www.igus.com>
email: sales@igus.com
QuickSpec: <http://www.igus.com/iglide-quickspec>

DryLin® W Linear Guide Systems

Single Rail and Bearing Block - Round

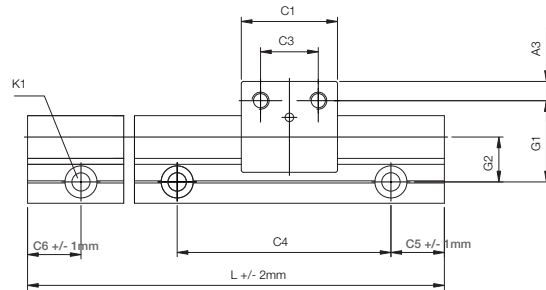
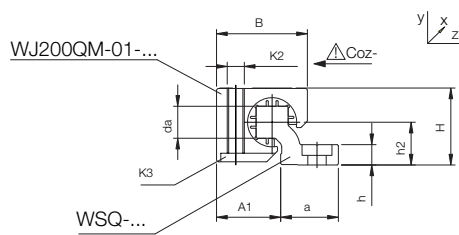
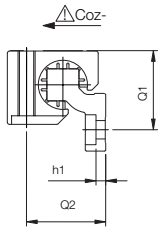

Part No.	Floating bearing play	Weight (g)	B (mm)	C1 (mm)	C3 (mm)	A3 (mm)	K2 (mm)	K3 (mm)	Static load capacity		
									Coy lbf (N)	Coz+ lbf (N)	Coz- lbf (N)

Zinc Block

WJ200UM-01-10	-	41	26	29	16	6.5	M6	M5	270 (1200)	270 (1200)	56 (250)
WJ200UM-01-16	-	100	34.5	36	18	9	M8	M6	472 (2100)	472 (2100)	89 (400)
WJ200UM-01-20	-	190	42.5	45	27	9	M8	M6	719 (3200)	719 (3200)	112 (500)

Floating (extra clearance)

WJ200UM0110LL	±0.2	41	26	29	16	6.5	M6	M5	270 (1200)	270 (1200)	56 (250)
WJ200UM0116LL	±0.2	100	34.5	36	18	9	M8	M6	472 (2100)	472 (2100)	89 (400)
WJ200UM0120LL	±0.2	190	42.5	45	27	9	M8	M6	719 (3200)	719 (3200)	112 (500)

Aluminum Block

WJ200UM0110AL	-	20	26	29	16	6.5	M6	M5	270 (1200)	270 (1200)	56 (250)
WJ200UM0116AL	-	47	34.5	36	18	9	M8	M6	472 (2100)	472 (2100)	89 (400)
WJ200UM0120AL	-	94	42.5	45	27	9	M8	M6	719 (3200)	719 (3200)	112 (500)

Floating

WJ200UM0110ALL	±0.2	41	26	29	16	6.5	M6	M5	270 (1200)	270 (1200)	56 (250)
WJ200UM0116ALL	±0.2	100	34.5	36	18	9	M8	M6	472 (2100)	472 (2100)	89 (400)
WJ200UM0120ALL	±0.2	190	42.5	45	27	9	M8	M6	719 (3200)	719 (3200)	112 (500)

DryLin® W Linear Guides with "Turn-to-Fit"



- Manual adjustable clearance by "Turn-To-Fit" function (allen key included in delivery)
- Adjusting screw: max. torque 0.1 Nm
- 100% lubrication-free
- Compact dimensions
- 8 different rail profiles available

Part No.	Weight (g)	B (mm)	C1 (mm)	C3 (mm)	A3 (mm)	K2 (mm)	H (mm)	SW (mm)	G1 (mm)	Required Allen Key
										(mm)
WJUME-01-10	43	26	29	16	6.5	M6	18	1.5	27	
WJ200UME-01-16	110	34.5	36	18	9	M8	27	2.5	33	
WJ200UME-01-20	222	42.5	45	27	9	M8	36	2.5	38	

DryLin® W Linear Guide Systems

PDF: www.igus.com/iglide-pdfs
 CAD: www.igus.com/iglide-CAD
 RoHS info: www.igus.com/RoHS



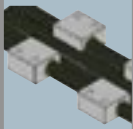

DryLin® W Linear Guide Systems Double Rail and Bearing Block - Square

DryLin® W Linear Guide Systems

Telephone 1-800-521-2747
Fax 1-401-438-7270

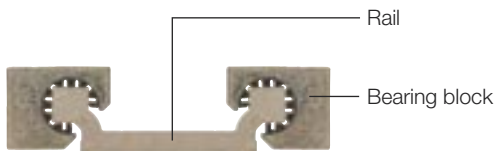
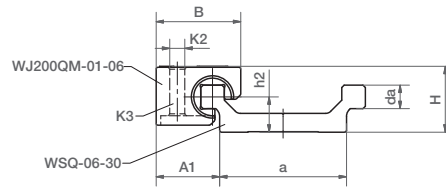
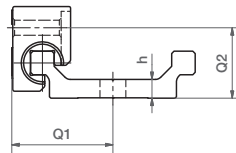
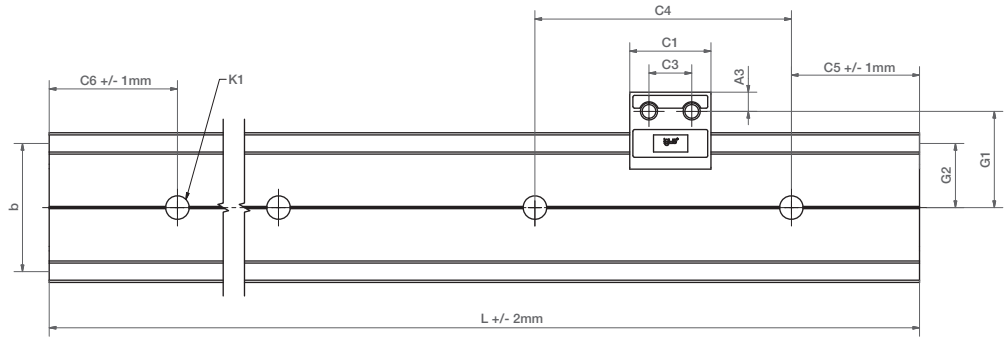

DryLin® W Guide Rails - Square

Part No.	Weight (kg/m)	H (mm)	da ± 0.07 (mm)	di -0.1 (mm)	L (mm)	a Max. (mm)	b -0,3 (mm)	h (mm)	h1 (mm)	h2 (mm)	G1 (mm)	G2 (mm)	A1 (mm)
WSQ-06-30	0.45	14	5	-	3000	27	30	4	4	7.5	22.5	10.5	13.5

Part No.	C4 (mm)	C5 Min. (mm)	C5 Max. (mm)	C6 Min. (mm)	C6 Max. (mm)	K1 for screw DIN 912	ly (mm²)	lz (mm²)	Wby (mm³)	Wbz (mm³)
WSQ-06-30	60	20	49.5	20	49.5	M4	19000	1250	1100	200

DryLin® W Bearing Block

Part No.	Weight (g)	B (mm)	C1 (mm)	C3 (mm)	A3 (mm)	K2 (mm)	K3 (mm)	Static load capacity		
								Coy (N)	Coz+ (N)	Coz- (N)
Zinc Block										
WJ200QM0106	16	18	19	10	4.5	M4	M3	94 (420)	94 (420)	31 (140)
Aluminum Block										
WJ200QM0106AL	7	18	19	10	4.5	M4	M3	94 (420)	94 (420)	31 (140)

Internet: <http://www.igus.com>
email: sales@igus.com
QuickSpec: <http://www.igus.com/iglide-quickspec>

DryLin® W Linear Guide Systems

Guide Carriage, Fitted - Square

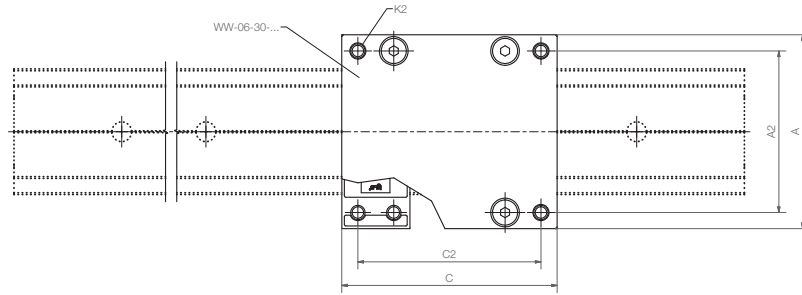

DryLin® W Carriages, fitted

Part No.	Weight (kg)							Static load capacity				
		A Width (mm)	C Length (mm)	A2 (mm)	C2 (mm)	K2 (mm)	H2 ±0.17 (mm)	Coy lbs (N)	Coz lbs (N)	Mox lbs (Nm)	Moy lbf-ft (Nm)	Moz lbf-ft (Nm)

For Guide Rail WSQ-06-30

Zinc Block

WW-06-30-06	0.10	54	60	45	51	M4	18	377 (1680)	188 (840)	18 (25)	25 (34)	25 (34)
WW-06-30-08	0.11	54	80	45	71	M4	18	377 (1680)	188 (840)	18 (25)	37 (51)	37 (51)
WW-06-30-10	0.12	54	100	45	91	M4	18	377 (1680)	188 (840)	18 (25)	50 (68)	50 (68)

Aluminum Block

WW-06-30-06AL	0.07	54	60	45	51	M4	18	377 (1680)	188 (840)	18 (25)	25 (34)	25 (34)
WW-06-30-08AL	0.08	54	80	45	71	M4	18	377 (1680)	188 (840)	18 (25)	37 (51)	37 (51)
WW-06-30-10AL	0.09	54	100	45	91	M4	18	377 (1680)	188 (840)	18 (25)	50 (68)	50 (68)

DryLin® W Linear
Guide Systems

PDF: www.igus.com/iglide-pdfs
CAD: www.igus.com/iglide-CAD
RoHS info: www.igus.com/RoHS





DryLin® W Linear Guide Systems Double Rail and Bearing Block - Round

DryLin® W Linear Guide Systems

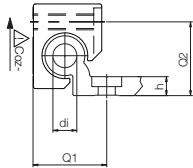
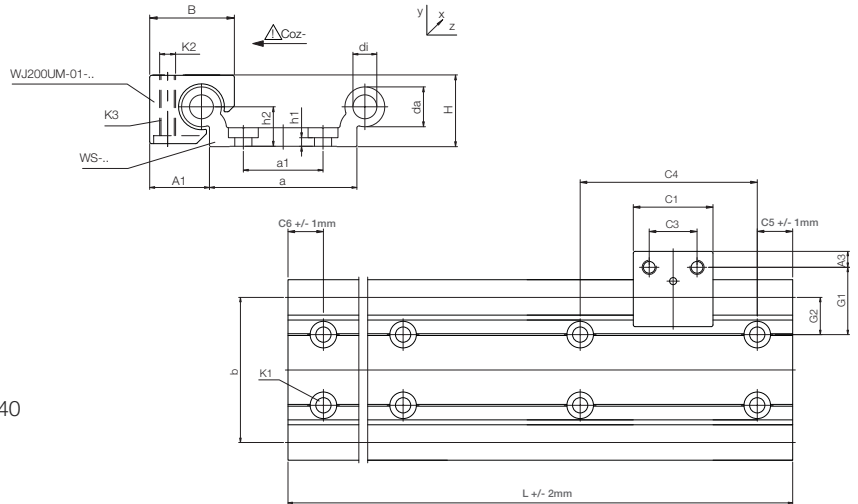
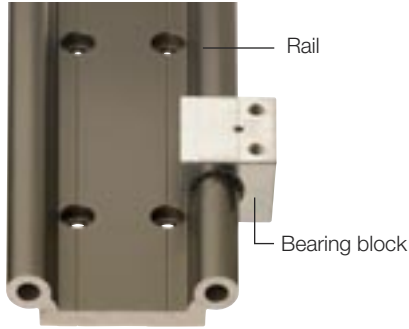

This bearing block orientation is not possible for WS-10-40 and WS-10-80

DryLin® W Guide Rails

Part No.	Weight (kg/m)	H ± 0.07 (mm)	da -0.1 (mm)	di	L Max. (mm)	a -0.3 (mm)	b (mm)	h (mm)	h1 (mm)	h2 (mm)	G1 (mm)	G2 (mm)	a1*
WS-10-40	1.00	18	10	-	4000	40	40	5.5	5.5**	9	27	17	-
WS-10-80	1.50	18	10	-	4000	74	74	5.5	5.5**	9	27	17	40
WS-16-60	1.96	27	16	8.0	4000	54	58	7.5	3.5	14	33	19	-
WS-20-80	3.30	36	20	10.2	4000	74	82	9.5	4.5	20	38	21	40

* WS-10-40 and WS-16-60 have a single row of mounting holes down the center line

** WS-10-80 and WS-20-80 have two parallel rows of mounting holes

Part No.	C4 (mm)	C5 Min. (mm)	C5 Max. (mm)	C6 Min. (mm)	C6 Max. (mm)	K1 for screw DIN 912	ly (mm²)	lz (mm²)	Wby (mm³)	Wbz (mm³)
WS-10-40	120	20	79.5	20	79.5	M6***	91000	5100	3600	590
WS-10-80	120	20	79.5	20	79.5	M6***	388000	6100	9200	650
WS-16-60	120	20	79.5	20	79.5	M8	367600	26100	9900	1900
WS-20-80	120	20	79.5	20	79.5	M8	1080000	78700	21000	4000

Standard bore pattern symmetrical: C5 = C6; please order C5 ≠ C6 with drawing. *** Through bore

DryLin® W Bearing Block

Part No.	Weight (g)	B (mm)	C1 (mm)	C3 (mm)	A3 (mm)	K2 (mm)	K3 (mm)	Static load capacity		
								Co _y (N)	Co _{z+} (N)	Co _{z-} (N)
Zinc Block										
WJ200UM-01-10	41	26	29	16	6.5	M6	M5	270 (1200)	270 (1200)	56 (250)
WJ200UM-01-16	100	34.5	36	18	9	M8	M6	472 (2100)	472 (2100)	89 (400)
WJ200UM-01-20	190	42.5	45	27	9	M8	M6	719 (3200)	719 (3200)	112 (500)
Aluminum Block										
WJ200UM0110AL	41	26	29	16	6.5	M6	M5	270 (1200)	270 (1200)	56 (250)
WJ200UM0116AL	100	34.5	36	18	9	M8	M6	472 (2100)	472 (2100)	89 (400)
WJ200UM0120AL	190	42.5	45	27	9	M8	M6	719 (3200)	719 (3200)	112 (500)
Aluminum Block										
WJ200UM0110AL	41	26	29	16	6.5	M6	M5	270 (1200)	270 (1200)	56 (250)
WJ200UM0116AL	100	34.5	36	18	9	M8	M6	472 (2100)	472 (2100)	89 (400)
WJ200UM0120AL	190	42.5	45	27	9	M8	M6	719 (3200)	719 (3200)	112 (500)

Telephone 1-800-521-2747
1-401-438-7270
Fax

Internet: <http://www.igus.com>
email: sales@igus.com
QuickSpec: <http://www.igus.com/iglide-quickspec>

DryLin® W Linear Guide Systems

Guide Carriage, Fitted - Round



*DryLin® W manual clamp (optional)
Use suffix HKA to the end of the part number when ordering
Example: WW-16-60-15HKA

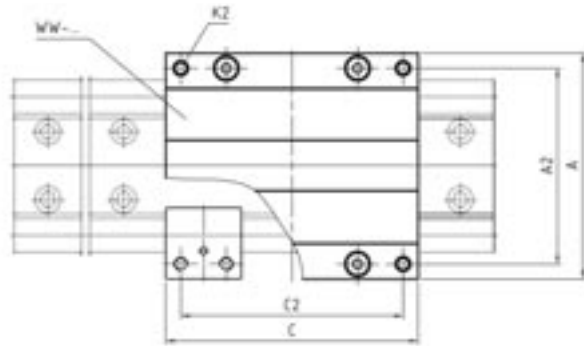

Also available as version with adjustable clearance in installation sizes 10, 16 and 20:
Order example, WWE-10-40-15

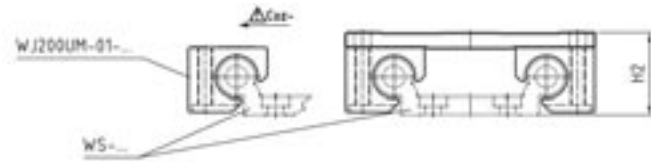

DryLin® W Carriages, fitted

Part No.	Weight (kg)	A Width (mm)	C Length (mm)	A2 (mm)	C2 (mm)	K2 (mm)	H2 ±0.17 (mm)	Coy lbs (N)	Static load capacity			
									Coz lbs (N)	Mox lbs (Nm)	Moy lbf-ft (Nm)	Moz lbf-ft (Nm)

(See Page 27.7 for more information)

For Guide Rail WS-10-40

Zinc Block

WW-10-40-10	0.29	73	100	60	87	M6	24	1079 (4800)	539 (2400)	70 (96)	125 (170)	125 (170)
WW-10-40-15	0.34	73	150	60	137	M6	24	1079 (4800)	539 (2400)	70 (96)	213 (290)	213 (290)
WW-10-40-20	0.40	73	200	60	187	M6	24	1079 (4800)	539 (2400)	70 (96)	302 (410)	302 (410)

Aluminum Block

WW-10-40-10AL	0.29	73	100	60	87	M6	24	1079 (4800)	539 (2400)	70 (96)	125 (170)	125 (170)
WW-10-40-15AL	0.34	73	150	60	137	M6	24	1079 (4800)	539 (2400)	70 (96)	213 (290)	213 (290)
WW-10-40-20AL	0.40	73	200	60	187	M6	24	1079 (4800)	539 (2400)	70 (96)	302 (410)	302 (410)

For Guide Rail WS-10-80

Zinc Block

WW-10-80-10	0.34	107	100	94	87	M6	24	1079 (4800)	539 (2400)	131 (178)	125 (170)	125 (170)
WW-10-80-15	0.42	107	150	94	137	M6	24	1079 (4800)	539 (2400)	131 (178)	213 (290)	213 (290)
WW-10-80-20	0.50	107	200	94	187	M6	24	1079 (4800)	539 (2400)	131 (178)	302 (410)	302 (410)

Aluminum Block

WW-10-80-10AL	0.34	107	100	94	87	M6	24	1079 (4800)	539 (2400)	131 (178)	125 (170)	125 (170)
WW-10-80-15AL	0.42	107	150	94	137	M6	24	1079 (4800)	539 (2400)	131 (178)	213 (290)	213 (290)
WW-10-80-20AL	0.50	107	200	94	187	M6	24	1079 (4800)	539 (2400)	131 (178)	302 (410)	302 (410)

For Guide Rail WS-16-60

Zinc Block

WW-16-60-10	0.71	104	100	86	82	M8	35	1888 (8400)	944 (4200)	177 (240)	199 (270)	199 (270)
WW-16-60-15	0.84	104	150	86	132	M8	35	1888 (8400)	944 (4200)	177 (240)	354 (480)	354 (480)
WW-16-60-20	0.97	104	200	86	182	M8	35	1888 (8400)	944 (4200)	177 (240)	508 (690)	508 (690)

Aluminum Block

WW-16-60-10AL	0.71	104	100	86	82	M8	35	1888 (8400)	944 (4200)	177 (240)	199 (270)	199 (270)
WW-16-60-15AL	0.84	104	150	86	132	M8	35	1888 (8400)	944 (4200)	177 (240)	354 (480)	354 (480)
WW-16-60-20AL	0.97	104	200	86	182	M8	35	1888 (8400)	944 (4200)	177 (240)	508 (690)	508 (690)

For Guide Rail WS-20-80

Zinc Block

WW-20-80-15	1.20	134	150	116	132	M8	44	2878 (12800)	1439 (6400)	387 (525)	494 (670)	494 (670)
WW-20-80-20	1.30	134	200	116	182	M8	44	2878 (12800)	1439 (6400)	387 (525)	730 (990)	730 (990)
WW-20-80-25	1.50	134	250	116	232	M8	44	2878 (12800)	1439 (6400)	387 (525)	922 (1250)	922 (1250)

Aluminum Block

WW-20-80-15AL	1.20	134	150	116	132	M8	44	2878 (12800)	1439 (6400)	387 (525)	494 (670)	494 (670)
WW-20-80-20AL	1.30	134	200	116	182	M8	44	2878 (12800)	1439 (6400)	387 (525)	730 (990)	730 (990)
WW-20-80-25AL	1.50	134	250	116	232	M8	44	2878 (12800)	1439 (6400)	387 (525)	922 (1250)	922 (1250)

DryLin® W Linear
Guide Systems

PDF: www.igus.com/iglide-pdfs
CAD: www.igus.com/iglide-CAD
RoHS info: www.igus.com/RoHS





DryLin® W – manual clamp

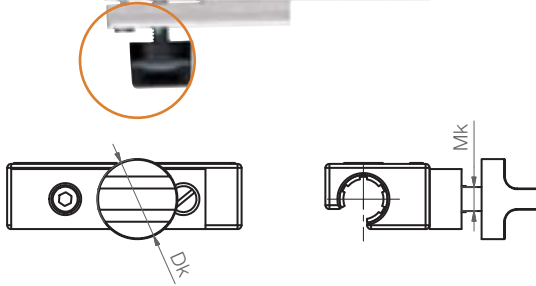

Special properties

- Cost-efficient option
- Universal applications
- Clamping force based on tightening torque
- Clamping by locking friction

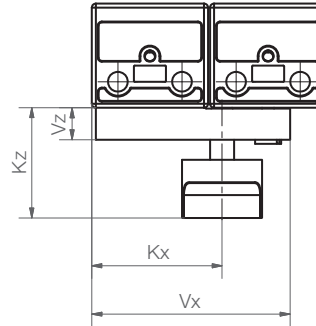

DryLin® W Manual Clamp

Part number	Mk (mm)	Vx (mm)	Kx (mm)	Vz (mm)	Kz (mm)	Dk (mm)	Min. holding strength** (N)	Min. tightening torque (Nm)
WHKA-10*	M6	50	33	8	28	20	30	0.8
WHKA-16*	M8	72	32	10	31	26	60	1.5
WHKA-20*	M8	90	29	10	31	26	70	1.5

*DryLin® W manual clamp is also available as a complete carriage us suffix HKA when ordering. Example: WW-10-40-10HKA

► Complete carriage WW page X.XX

** Condition: dry rail surface

Please Note: The creep behavior of the clamped plastic results in reduced clamping force over time (up to 70%). Therefore safety-related parts should use an alternative method.

DryLin® W Linear Guide Systems Accessories



DryLin® W – manual clamp

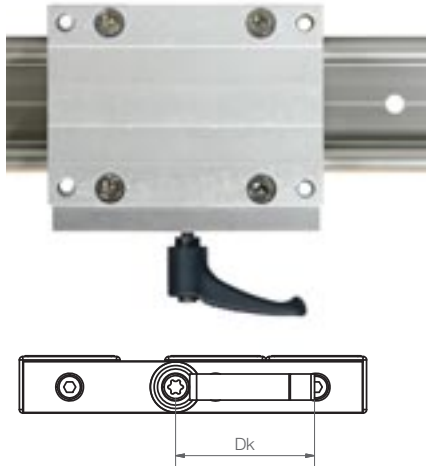

Special properties

- Available as single part or assembled on guide carriage
- Clamping force based on tightening torque
- Clamping by locking friction

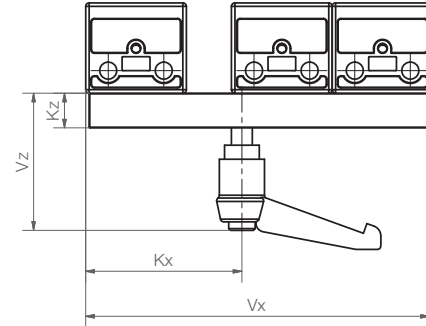

DryLin® W Manual Clamp

Part number	Mk (mm)	Vx (mm)	Kx (mm)	Vz (mm)	Kz (mm)	Dk (mm)	Min. holding strength** (N)	Min. tightening torque (Nm)
WHKD-10*	M6	99	45	40	10	40	70 N	2.5 Nm
WHKD-20*	M8	149	87	-	15	-	90 N	3.5 Nm

*DryLin® W manual clamp is also available as a complete carriage us suffix HKA when ordering. Example: WW-10-40-10HKD

► Complete carriage WW page X.XX

** Condition: dry rail surface

Please Note: The creep behavior of the clamped plastic results in reduced clamping force over time (up to 70%). Therefore safety-related parts should use an alternative method.

DryLin® W – digital measuring device

Special properties

- **Installation:** right (R) or left (L) of guide carriage
- **Measuring principle:** magnetic with magnetic tape (10 x 1.4 mm)
- **Resolution:** 0.1 mm
- **Accuracy:** $\pm 0.1 + 0.01 \times \text{measured length (m)}$ mm
- **Service life:** 5 years powered 100% of the time
- **Operation temperature:** +32 °F to +140 °F
- **Display:** LCD
- **Repeat accuracy:** ± 1 Digit
- **Absolute and incremental measuring method**



Wireless measuring device with direct, digital indication of position
Part No.: WKM-10 / WKM-20

Clean room suitability and ESD-compatibility



You can find detailed results on
► Page 25.12

DryLin® W Linear Guide Systems

PDF: www.igus.com/iglide-pdfs
CAD: www.igus.com/iglide-CAD
RoHS info: www.igus.com/RoHS



mm

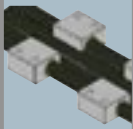

DryLin® W Linear Guide Systems Hybrid Linear Bearing - Roll and Slide

DryLin® W Linear
Guide Systems

Telephone 1-800-521-2747
Fax 1-401-438-7270

Internet: <http://www.igus.com>
email: sales@igus.com
QuickSpec: <http://www.igus.com/iglide-quickspec>

An additional DryLin® W solution is a combined rolling and sliding carriage. Because of the defined load direction the required drive force is reduced by a maintenance free roller bearing. This system represents an ideal solution for many hand powered applications. Ideal for machine tool guards, furniture and camera/film applications.

- Roller made of plastic
- Liner made of iglide® J
- Low drive force needed, friction: 0.04-0.05μ
- Cost-effective vs. other roller systems
- Can be combined with 7 linear profile rails

Compatible Guide Rails

WS-10	Page 27.12
WS-10-40	Page 27.16
WS-10-80	Page 27.16
WS-16	Page 27.12
WS-16-60	Page 27.16
WS-20	Page 27.12
WS-20-80	Page 27.16

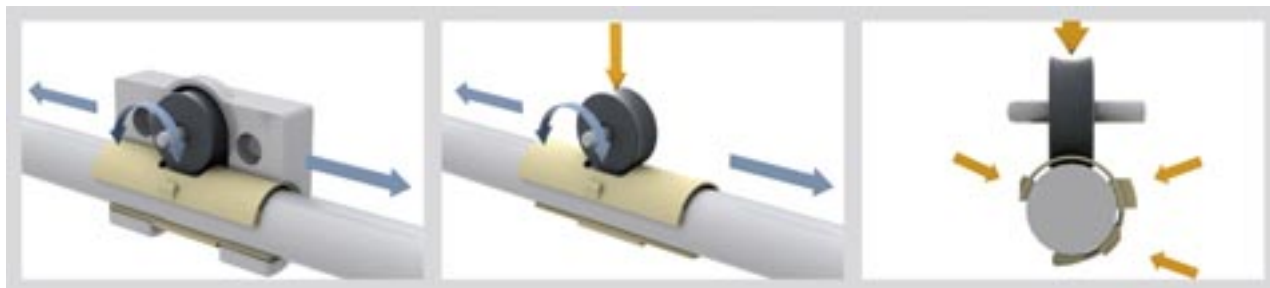

Load Data and Dimensions

Part number	Stat. load capacity Co [N]	Dyn. load capacity Cz+ at total running distance (km)			F · v max. (N · m/s)
		10	100	200	
WJRM-01-10	250	250	90	50	50
WJRM-01-16	400	400	140	70	80
WJRM-01-20	550	550	200	100	80

Part number	Friction in +z direction	Weight (g)	B	B2	C1	C3	G1	A3	A1	K2	K3 (N)	Q1	Q2
WJRM-01-10	< 0.1	46	26	2.5	35	22	27	6.5	16.5	M6	M5	-	-
WJRM-01-16	< 0.1	131	34.5	5	48	30	33	9	25	M8	M6	32	28
WJRM-01-20	< 0.1	232	42.5	6	52	34	38	9	30	M8	M6	37	37

DryLin® W Linear Guide Systems

Hybrid Linear Bearing - Roll and Slide

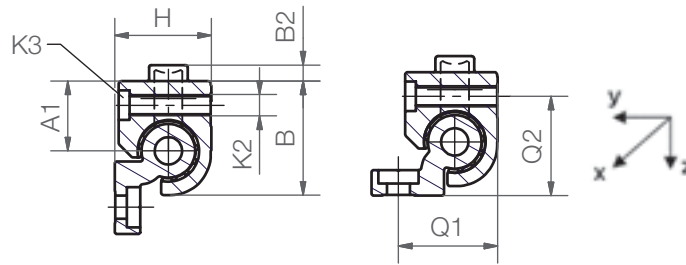
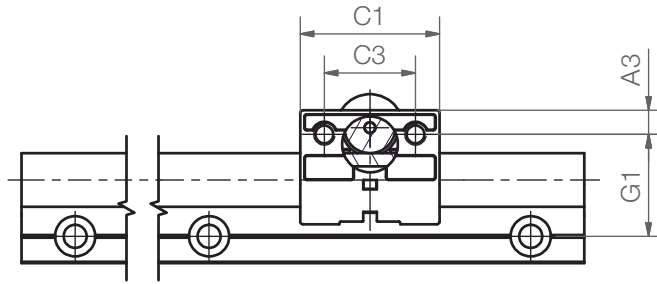

This installation position is not possible for combination of WJRM-01-10 with rail WS-10/WS-10-40/WS-10-80

Load Data and Dimensions

Part No.	Friction in +z direction	Weight (g)	B (mm)	B2 (mm)	C1 (mm)	C3 (mm)	G1 (mm)	A3 (mm)	A1 (mm)	K2 (mm)	K3 (N)	Q1 (mm)	Q2 (mm)
WJRM-01-10	<0.1	46	26	2.5	35	22	27	6.5	16.5	M6	M5	-	-
WJRM-01-16	<0.1	131	34.5	5	48	30	33	9	25	M8	M6	32	28
WJRM-01-20	<0.1	232	42.5	6	52	34	38	9	30	M8	M6	37	37

DryLin® W Linear Guide Systems

PDF: www.igus.com/iglide-pdfs
 CAD: www.igus.com/iglide-CAD
 RoHS info: www.igus.com/RoHS





DryLin® W Linear Guide Systems, 316 Stainless Steel

DryLin® W Linear
Guide Systems

Telephone 1-800-521-2747
1-401-438-7270
Fax

Internet: <http://www.igus.com>
email: sales@igus.com
QuickSpec: <http://www.igus.com/iglide-quickspec>

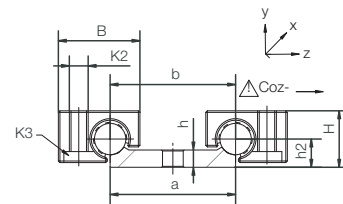
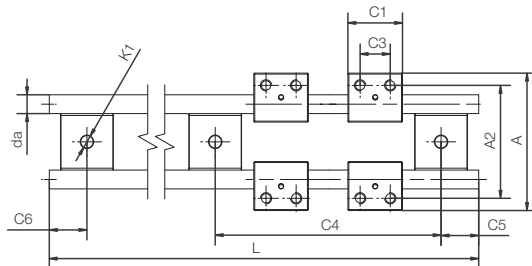
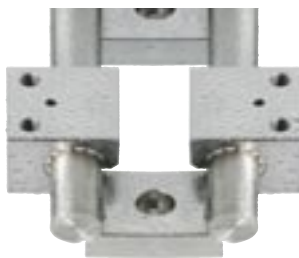

DryLin® W Guide Rail, Double, ø 10 mm

Part No.	Suitable bearing (Part No.)	Weight (kg/m)	da h9 (mm)	L Max. (mm)	a -0,3 (mm)	b (mm)	h (mm)	h2 (mm)
WS-10-40-ES (FG)	WJUM-01-10-ES (FG)	1.58	10	3000	40	40	5.5	9

(FG) - cast 316

Part No.	C4 (mm)	C5 Min. (mm)	C5 Max. (mm)	C6 Min. (mm)	C6 Max. (mm)	K1 for screw DIN 912
WS-10-40-ES (FG)	120	20	79.5	20	79,5	M6

(FG) - cast 316

DryLin® W Bearing Blocks

Part No.	Weight (g)	H ±0,07 (mm)	B (mm)	C1 (mm)	C3 (mm)	A (mm)	A2 (mm)	K2 (mm)	K3 Countersunk screw	Static load capacity		
										Coy lbs (N)	Coz+ lbs (N)	Coz- lbs (N)
WJUM-01-10-ES (FG)*	57	18	26	29	16	73	60	M6	M5	854 (3800)	854 (3800)	213 (950)

(FG) - cast 316

* TUMO-01-10 liners are optional extra, page 27.26, for high temperatures

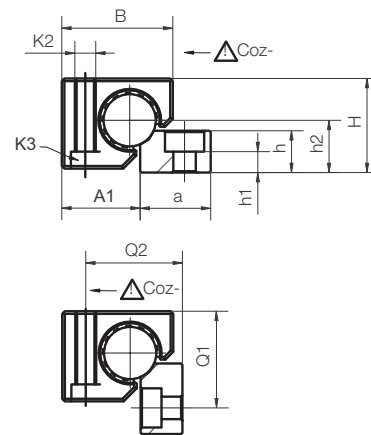
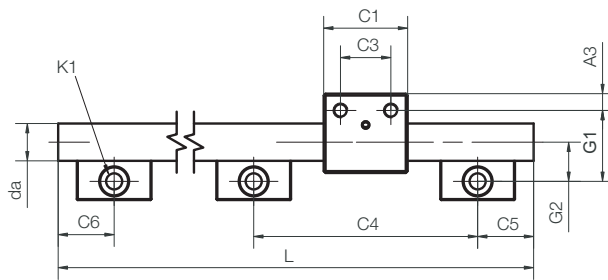

DryLin® W-Guide rail, single, ø 20 mm

Part No.	Suitable bearing (Part No.)	Weight (kg/m)	da h9 (mm)	L Max. (mm)	a -0,3 (mm)	h (mm)	h2 (mm)	G2 (mm)
WS-20-ES (FG)	WJUM-01-20-ES (FG)	3.37	20	3000	27	16	20	21

(FG) - cast 316

Part No.	C4 (mm)	C5 Min. (mm)	C5 Max. (mm)	C6 Min. (mm)	C6 Max. (mm)	K1 for screw DIN 912	h1 (mm)	ly (mm²)	lz (mm²)	Wby (mm³)	Wbz (mm³)
WS-20-ES (FG)	120	20	79.5	20	79,5	M8	8	7854	7854	785	785

(FG) - cast 316

DryLin® W housing bearings

Part No.	WT (g)	H ±0,07 (mm)	B (mm)	C1 (mm)	C3 (mm)	G1 (mm)	A3 (mm)	A1 (mm)	K2 Countersunk-head screw (mm)	K3 (mm)	Q1 (mm)	Q2 Coy (N)	Static load capacity		
													Coz+ (N)	Coz- (N)	
WJUM-01-20-ES (FG)*	280	36	42.5	45	27	38	9	30	M8	M6	37	37	2473 (11000)	2473 (11000)	4270 (1900)

* TUMO-01-20 liners are optional for high temperatures up to 482°F
(FG) - cast 316



Navigation icons: +, |, i, inch, mm



DryLin® T Linear Guide Systems

DryLin® T Linear
Guide Systems

Telephone 1-800-521-2747
Fax 1-401-438-7270

Internet: <http://www.igus.com>
email: sales@igus.com
QuickSpec: <http://www.igus.com/iglide-quickspec>

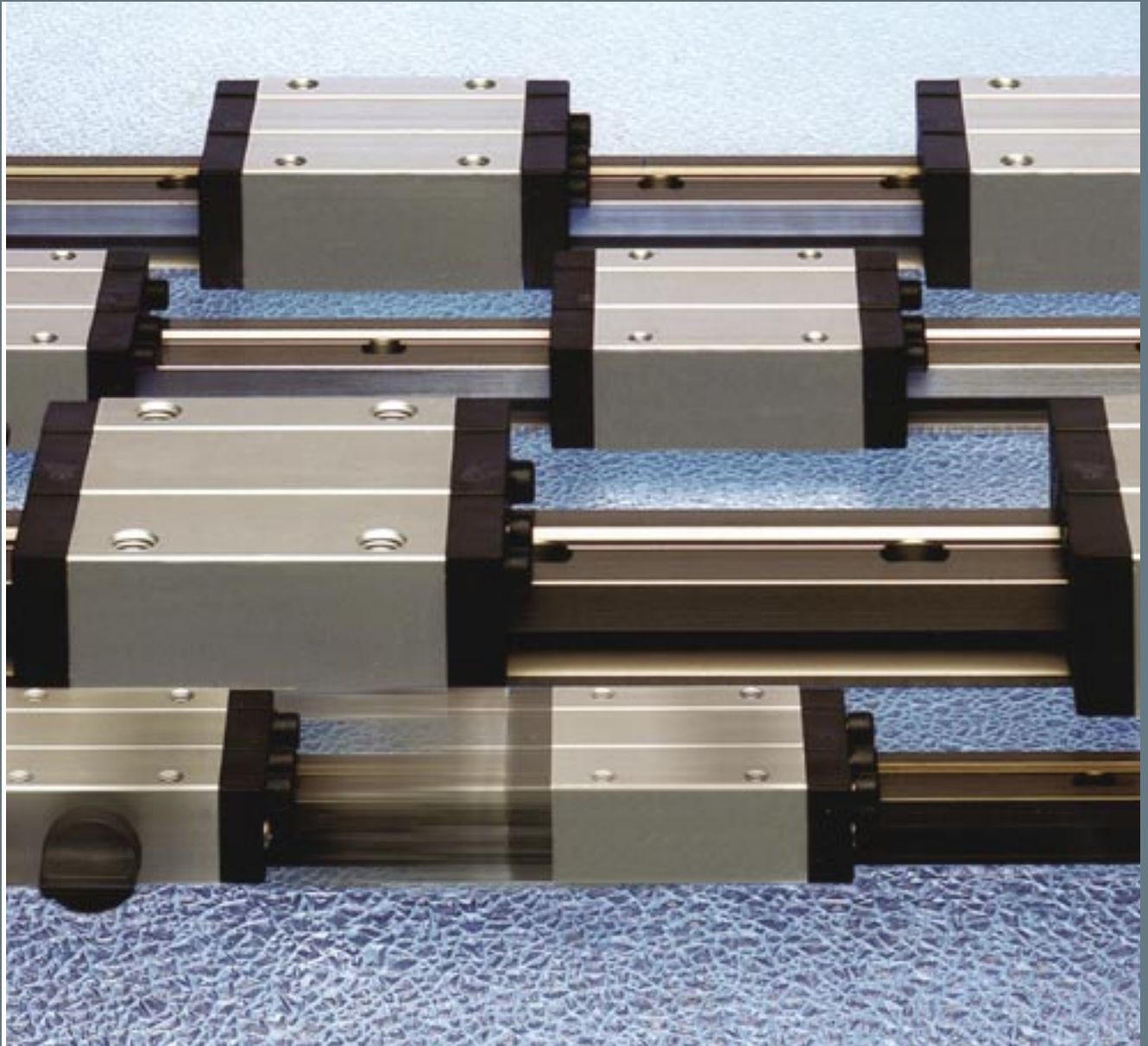

DryLin[®] T Linear Guide System
Maintenance-Free, Adjustable,
and Quiet

DryLin® T Selection Guide



Series TW-01-XX Adjustable clearance

- Pre-set from factory for optimal standard clearance
- Clearance can be reduced for higher precision requirements
- Clearance can be increased to compensate for poor mounting surface tolerances



Series TWA-01-XX Automatic

- Clearance automatically adjusts
- Maintains better precision over lifetime vs. TW-01 version



Series TW-HKA Manual Hand Clamp

- Allows a simple hand-clamp function for light-duty applications
- Not recommended for vertical applications



Series TW-02-XX Heavy Duty

- Better for aggressive and heavy industrial environments due to metal end caps
- Ideal for applications containing weld splatter, dirt, wood chips, etc.
- Same loading as Series TW-01



Miniature

- Lightweight
- Ideal for tight design constraints
- Cost-effective



Series TWBM Heavy-Duty Clamps

- Offer higher clamping force than TW-HKA
- Holding forces up to 112 lbs

Temperature

Maximum Load

-40°F to +194°F
(-40°C to +90°C)

From
900 lbs (4000 N)
to
3140 lbs (14,000 N)

-40°F to +194°F
(-40°C to +90°C)

From
900 lbs (4000 N)
to
3140 lbs (14,000 N)

-40°F to +194°F
(-40°C to +90°C)

From
900 lbs (4000 N)
to
3140 lbs (14,000 N)

-40°F to +194°F
(-40°C to +90°C)

From
900 lbs (4000 N)
to
3140 lbs (14,000 N)

-40°F to +194°F
(-40°C to +90°C)

From
108 lbs (480 N)
to
315 lbs (1,400 N)

-40°F to +194°F
(-40°C to +90°C)

NA

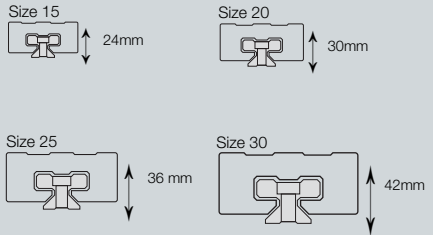
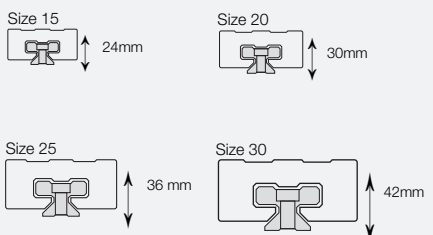
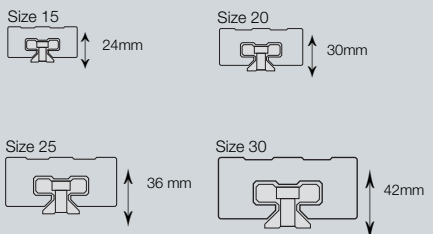
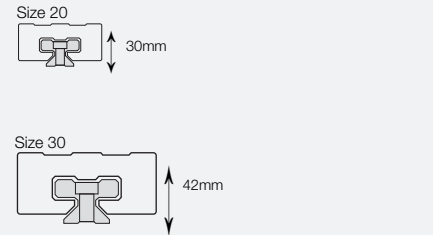
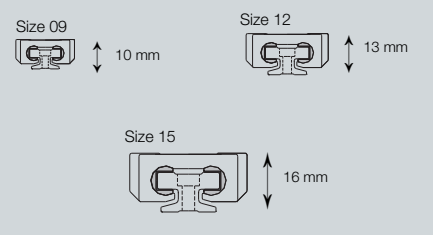
Maximum Speed	Maximum Rail Length	Size Range	Rail Material	Carriage Material
49 fps (15 m/s)	12 ft (4m upon request)		Hard-Anodized Aluminum	Plastic liners Aluminum carriages Stainless steel fasteners
49 fps (15 m/s)	12 ft (4m upon request)		Hard-Anodized Aluminum	Plastic liners Aluminum carriages Stainless steel fasteners
49 fps (15 m/s)	12 ft (4m upon request)		Hard-Anodized Aluminum	Plastic liners Aluminum carriages Stainless steel fasteners
49 fps (15 m/s)	12 ft (4m upon request)		Hard-Anodized Aluminum	Plastic liners Anodized Aluminum
49 fps (15 m/s)	6.56 ft (2000 mm)		Hard-Anodized Aluminum	Plastic liners Chromated zinc carriage
NA	NA		Hard-Anodized Aluminum	Anodized Aluminum

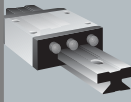

DryLin® T Linear Guide Systems

DryLin® T Linear Guide Systems

Telephone 1-800-521-2747
 Fax 1-401-438-7270

Internet: <http://www.igus.com>
 email: sales@igus.com
 QuickSpec: <http://www.igus.com/iglide-quickspec>

28.4

Technical Data

Sliding elements:

Self-lubricating polymer

Material:

iglide® J*

Max. surface speed:

49 fps (15 m/s)

Temperature range:

-40° F to +194°F

(-40 °C to +90 °C)

* Other materials upon request

Special Features



Cleanroom certified - IPA Fraunhofer



ESD compatible (electrostatic discharge)



Free of toxins - RoHS 2002/95/EC



DryLin® linear guide system in a treatment machine



Valve machining produces an extreme environment



DryLin® T linear guide system in pneumatic doors of tool changers

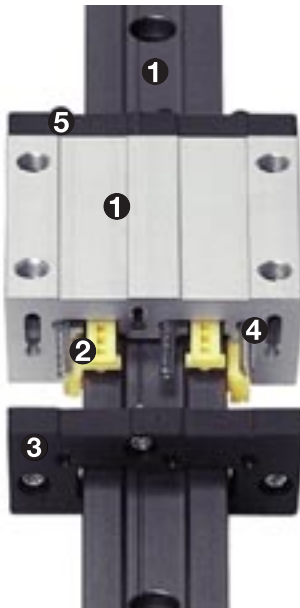

- 1 The rail is hard anodized, the aluminum carriage housing is clear anodized, or chromated zinc (mini series)
- 2 6 sliding iglide® J elements act as guide bearings
- 3 Clearance can be adjusted manually or automatically (depending on series)
- 4 All steel parts are galvanized or stainless steel
- 5 The end plate is solid plastic with an optional aluminum - HD carriage option

Technical Data

Guide Rails

Material	Aluminum, extruded
Substance	6063-T6 or 6060-T66 (Al Mg Si 0.5)
Coating	Hard-anodized aluminum, .002" (50 µm)
Hardness	500 HV

Sliding Carriages

Base Structure	Aluminum, extruded section (TK01/TKA/TKC1), Zinc (TK04)
Material	6060-T66 (Al Mg Si 0.5)
Coating	Clear Anodized
Sliding Elements	iglide® J, maintenance-free, plain bearing material
Bolts	Stainless steel
Springs	Stainless steel
Cover	Plastic or aluminum (HD version)
Max. Surface Speed	49 ft/s (15 m/s)
Temperature Range	-40°F to 194°F (-40°C to +90°C)

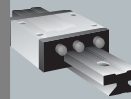

Features

- With low inertia rates, high accelerations and speeds up to 49 fps (15 m/s) are possible
- Oil and maintenance-free
- Ideal for use in lab, food-processing, and packaging machinery
- Excellent corrosion resistance
- Dimensionally interchangeable with common linear ball bearings
- Excellent in dirty environments without the need of wipers or seals



DryLin® T in a demanding packaging machine application

DryLin® T Linear Guide Systems

DryLin® T - Load / Speed Capacity

DryLin® T Linear Guide Systems can hold high static loads because of large surface areas. The maximum load in the y-direction is higher than in the z-direction, since the bearing surface is doubled in the y-direction. With a low rate of inertia, high accelerations and short term extreme speeds up to 49 ft/s (15 m/s) are possible.

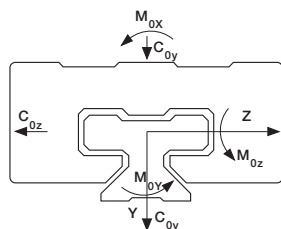

Designation of load directions

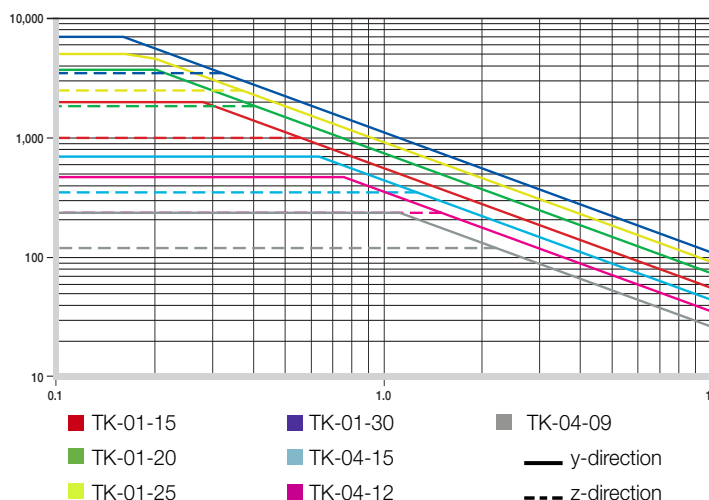

Type	C_{0y}		$C_{0(y)}$		C_{0z}		M_{0x}		M_{0y}		M_{0z}	
	lbs	(kN)	lbs	(kN)	lbs	(kN)	ft lbs	(Nm)	ft lbs	(Nm)	ft lbs	(Nm)
01-15	900	4	900	4	450	0.24	24	3.4	18	1.8	18	1.8
01-20	1665	7.4	1665	7.4	833	0.48	62	9.2	32	4.4	32	4.4
01-25	2250	10	2250	10	1125	0.7	92	17	48	8	48	8
01-30	3140	14	3140	14	1570	2	148	32	74	25	74	25
04-09	108	.48	108	.48	54	3.7	2.5	85	1.3	45	1.3	45
04-12	215	.96	215	.96	108	5	6.8	125	3.2	65	3.2	65
04-15	315	1.4	315	1.4	157	7	12.5	200	6.0	100	6.0	100

Table 20.1: DryLin® T permissible static load capacity

Eccentric Forces

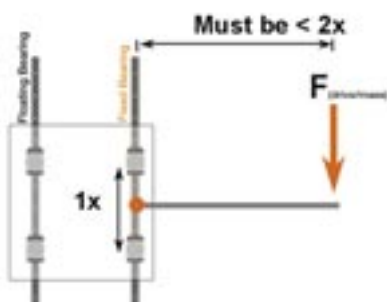

2:1 Rule = permissible distances of the applied forces

The 2:1 Rule

When using linear plain bearings it is important to ensure that the acting forces follow the 2:1 Rule (see drawing). If either the load or the drive force (F) is greater than twice the bearing length (1X), then a binding or interrupted motion may occur.

If the location of the drive force or load cannot be changed, simply increase the distance between the bearings, or create a counterbalance to move the center-of-gravity back within the 2 to 1 ratio.



Online Lifetime Calculation
www.igus.com

PDF: www.igus.com/iglide-pdfs
CAD: www.igus.com/iglide-CAD
RoHS info: www.igus.com/RoHS



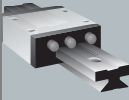

DryLin® T - Floating Systems

Maximum float = .04" (1 mm)



Standard Version



Horizontal Float "LLZ"



Vertical Float "LLY"

Part-No. Standard
TW-01-15
TW-01-20
TW-01-25
TW-01-30

Part-No. Floating Horizontal
TW-01-15HF
TW-01-20HF
TW-01-25HF
TW-01-30HF

Part No. Floating Vertical
TW-01-15VF
TW-01-20VF
TW-01-25VF
TW-01-30VF

DryLin® T - Fixed and Floating Bearing Mounting Instructions

When using systems with 2 parallel rails, one side must be designated as the "fixed" rail, and the opposite side the "floating" rail.

Why use floating bearings?

- promotes smooth gliding performance and maximizes bearing life
- prevents binding caused by parallelism and angle errors
- decreases necessary drive force and wear by minimizing friction-forces
- Enhances the precision of the system over the bearings' lifetime.
- Reduce assembly time and cost

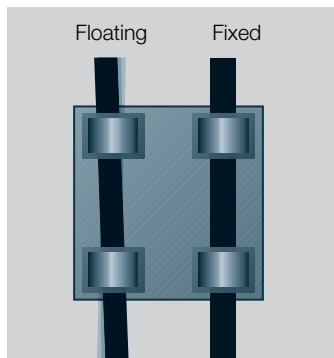

Automatic compensation of parallelism errors

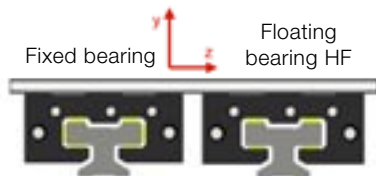

Installation variation horizontal with floating bearing in the Z-direction

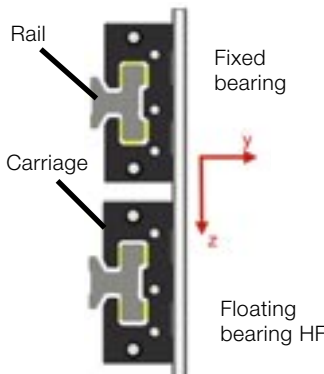

Installation variation lateral with floating bearing in the Z-direction

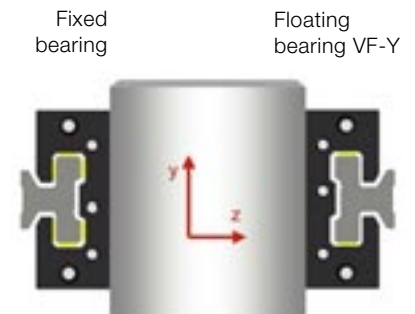

Horizontal mounting version with floating bearing in the Y-direction and lateral mounting carriage

Fixed Bearings

The "fixed" bearing rail should be positioned closest to the drive force. This rail will determine the precision of the system; no system should contain more than two "fixed" bearings.

Floating/Self-Aligning Bearings

The "floating" rail should be the rail located furthest from the drive force. It is to act only as a guide, and will compensate for any misalignments or angle errors in the system ensuring proper functionality.

Mounting Surfaces

The mounting surfaces for rails and bearings should have a very flat surface (e.g milled surface) in order to enhance performance. Variations in these surfaces may be compensated for by using floating bearings.

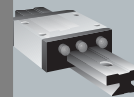

Cleanroom Suitability and ESD Compatibility of DryLin®

Linear Guide Systems by igus® GmbH

All DryLin® guide systems are clearly qualified for clean room applications. The differentiation between the various clean room classes is only dependent on load and speed of the application. The combination of iglide® J and hard anodized aluminum is classified as level 1 in the ESD compatibility according to SEMI E78-0998 (Highest rank).



The measurement results of the ESD compatibility according to SEMI E78-0998 show that the linear guide system DryLin® NK-02-40-02 can be classified as “level 1” (Highest rank). See Fraunhofer IPA Report No.: IG 0308-295 73.

The following DryLin® guide systems by igus® were examined: N40, W10, T25 and T30.
See below for detailed results.

Linear guide system DryLin® TK-10-30-01:

“For the linear guide system DryLin® TK-10-30-01 by igus®, it is possible, on the calculations of the likelihood of violation of threshold values of the detection sizes 0.2 µm, 0.3 µm, 0.5 µm, and 5 µm with motion speed of $v = 0.1$ m/s, to clearly derive suitability for clean rooms classified as ISO Class 3 according to DIN EN ISO 14644-1.”

Linear guide system DryLin® NK-02-40-02:

“For the linear guide system DryLin® NK-02-40-02 by igus®, it is possible, on the calculations of the likelihood of violation of threshold values of the detection sizes 0.2 µm, 0.3 µm, 0.5 µm, and 5 µm with motion speed of $v = 1$ m/s, to clearly derive suitability for clean rooms classified as ISO Class 6 according to DIN EN ISO 14644-1.”

Linear guide system DryLin® TK-01-25-02:

“For the linear guide system DryLin® TK-01-25-02 by igus®, it is possible, on the calculations of the likelihood of violation of threshold values of the detection sizes 0.2 µm, 0.3 µm, 0.5 µm, and 5 µm with motion speed of $v = 1$ m/s, to clearly derive suitability for clean rooms classified as ISO Class 5 according to DIN EN ISO 14644-1.”

The measurement results of the ESD compatibility according to SEMI E78-0998 show that the linear guide system DryLin® TK-01-25-02 can be classified as “level 1” (Highest rank).

Linear guide system DryLin® WK-10-40-15-01:

“For the linear guide system DryLin® WK-10-40-15-01 by igus®, it is possible, on the calculations of the likelihood of violation of threshold values of the detection sizes 0.2 µm, 0.3 µm, 0.5 µm, and 5 µm with motion speed of $v = 1$ m/s, to clearly derive suitability for clean rooms classified as ISO Class 6 according to DIN EN ISO 14644-1.”

The measurement results of the ESD compatibility according to SEMI E78-0998 show that the linear guide system DryLin® WK-10-40-15-01 can be classified as “level 1” (Highest rank).

See Fraunhofer IPA Report No.: IG 0308-295 74.

PDF: www.igus.com/iglide-pdfs
CAD: www.igus.com/iglide-CAD
RoHS info: www.igus.com/RoHS



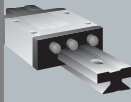

DryLin® T Linear Guide Systems - Adjustable Clearance

DryLin® T Linear Guide Systems

Telephone 1-800-521-2747
1-401-438-7270
Fax

Internet: <http://www.igus.com>
email: sales@igus.com
QuickSpec: <http://www.igus.com/iglide-quickspec>

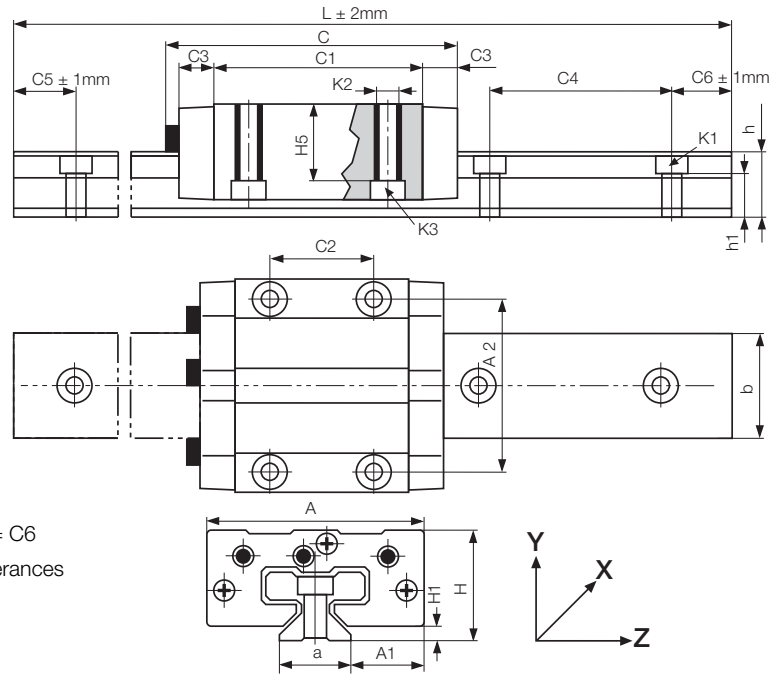

- Linear plain bearings
- Adjustable clearance
- Maintenance-free, dry operation
- Corrosion resistant
- Hard anodized aluminum rails (6063-T6)
- Clear anodized aluminum carriage
- Standard bore pattern symmetrical for rail, C5 = C6
- No charge for rails cut to standard C5 + C6 tolerances

DryLin® T guide rails

Part No.	Weight (kg/m)	L max. (mm)	a -0.2 (mm)	C4 (mm)	C5		C6		h	h1	K1 for Screw DIN 912	b (mm)	ly (mm ²)	lz (mm ²)	Wby (mm ²)	Wbz (mm ²)
					min. (mm)	max. (mm)	min. (mm)	max. (mm)								
TS-01-15	0.6	3650	15	60	20	49	20	49	15.5	10.0	M 4	22	6440	4290	585	488
TS-01-20	1.0	3650	20	60	20	49	20	49	19.0	12.3	M 5	31	22570	11520	1456	1067
TS-01-25	1.3	3650	23	60	20	49	20	49	21.5	13.8	M 6	34	34700	19300	2041	1608
TS-01-30	1.9	3650	28	80	20	59	20	59	26.0	15.8	M 8	40	70040	40780	3502	2832

Order example: TS-01-15, 2000 for a guide rail TS-01-15 of 2 m length

For rails without mounting holes, please use part number suffix "S"

*4000 mm length available upon request

DryLin® T carriages

Part No.	Weight (kg)	H ±0.35 (mm)	A (mm)	C (mm)	A1		C1 (mm)	C2 (mm)	C3 (mm)	H1		H5 (mm)	K2 Thread	Torque Max. (Nm)	K3 for Screw DIN 912
					±0.35 (mm)	(mm)				±0.35 (mm)	(mm)				
TW-01-15	0.11	24	47	68	16.0	38	50	30	9	4.0	16.0	M 5	1.5	M 4	
TW-01-20	0.19	30	63	81	21.5	53	61	40	10	5.0	19.8	M 6	2.5	M 5	
TW-01-25	0.29	36	70	90	23.5	57	68	45	11	5.0	24.8	M 8	6.0	M 6	
TW-01-30	0.50	42	90	103	31.0	72	79	52	12	6.5	27.0	M 10	15.0	M 8	

Order examples: TW-01-20 for a guide carriage

TW-01-20, LLy for a guide carriage with floating bearing in y-direction, 1mm additional clearance

TW-01-20, LLz for a guide carriage with floating bearing in z-direction, 1mm additional clearance

Structure – part no.

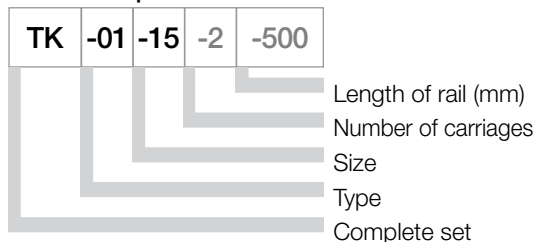

This order example (TK-01-15-2-500) corresponds to a complete DryLin® system of size 15 with 2 carriages and 500 mm rail length. Order TK-01-15-2-500-LLY for a complete system with floating bearing in y-direction.

DryLin® T Linear Guide Systems - Automatic

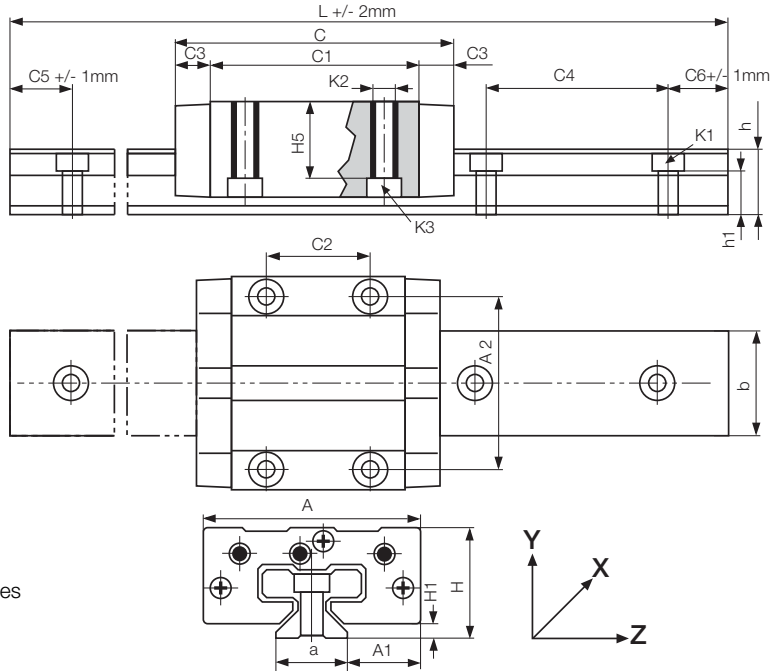
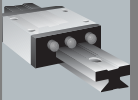

- Automatic clearance adjustment
- Linear plain bearings
- Maintenance-free, dry operation
- Corrosion resistant
- Hard anodized aluminum rails (6063-T6)
- Clear anodized aluminum carriage
- Standard bore pattern symmetrical for rail, C5 = C6
- No charge for rails cut to standard C5 + C6 tolerances
- Clearance adjusts when applied load is removed

DryLin® T guide rails

Part No.	Weight (kg/m)	L max. (mm)	a -0.2 (mm)	C4 (mm)	C5 min. (mm)	C5 max. (mm)	C6 min. (mm)	C6 max. (mm)	h (mm)	h1 (mm)	K1 for Screw DIN 912	b (mm)	ly (mm²)	lz (mm²)	Wby (mm²)	Wbz (mm²)
TS-01-15	0.6	3650	15	60	20	49.5	20	49.5	15.5	10.0	M 4	22	6440	4290	585	488
TS-01-20	1.0	3650	20	60	20	49.5	20	49.5	19.0	12.3	M 5	31	22570	11520	1456	1067
TS-01-25	1.3	3650	23	60	20	49.5	20	49.5	21.5	13.8	M 6	34	34700	19300	2041	1608
TS-01-30	1.9	3650	28	80	20	59.5	20	59.5	26.0	15.8	M 8	40	70040	40780	3502	2832

Order example: TS-01-15, 2000 for a guide rail TS-01-15 of 2 m length

For rails without mounting holes, please use part number suffix "S"

*4000 mm length available upon request

DryLin® T carriages with automatic clearance adjustment

Part No.	Weight (kg)	H ±0.35 (mm)	A (mm)	C (mm)	A1 ±0.35 (mm)	A2 (mm)	C1 (mm)	C2 (mm)	C3 (mm)	H1 ±0.35 (mm)	H5 (mm)	K2- Thread	Torque max. (Nm)	K3 for Screw DIN 912
TWA-01-15	0.11	24	47	68	16.0	38	50	30	9	4.0	16.0	M 5	1.11	M 4
TWA-01-20	0.19	30	63	81	21.5	53	61	40	10	5.0	19.8	M 6	1.84	M 5
TWA-01-25	0.29	36	70	90	23.5	57	68	45	11	5.0	24.8	M 8	4.43	M 6
TWA-01-30	0.50	42	90	103	31.0	72	79	52	12	6.5	27.0	M 10	11.06	M 8

Order examples: TWA-01-20 for a guide carriage

TWA-01-20, Lly for a guide carriage with floating bearing in y-direction, 1mm additional clearance

TWA-01-20, LLz for a guide carriage with floating bearing in z-direction, 1mm additional clearance



DryLin® T used in packaging machines

DryLin® T Linear Guide Systems

PDF: www.igus.com/iglide-pdfs
 CAD: www.igus.com/iglide-CAD
 RoHS info: www.igus.com/RoHS



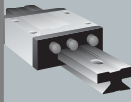

DryLin® T Linear Guide Systems - Manual Clamping

DryLin® T Linear Guide Systems

Telephone 1-800-521-2747
1-401-438-7270
Fax

Internet: <http://www.igus.com>
email: sales@igus.com
QuickSpec: <http://www.igus.com/iglide-quickspec>



- With manual clamp for simple locking functions. Plastic may creep over time resulting in decreased clamping forces (up to 70%). Please call igus® for other alternatives for demanding applications
- Linear plain bearings
- Adjustable clearance
- Maintenance-free, dry operation
- Corrosion resistant
- Standard bore pattern symmetrical for rail, C5 = C6
- No charge for rails cut to standard C5/C6 tolerances

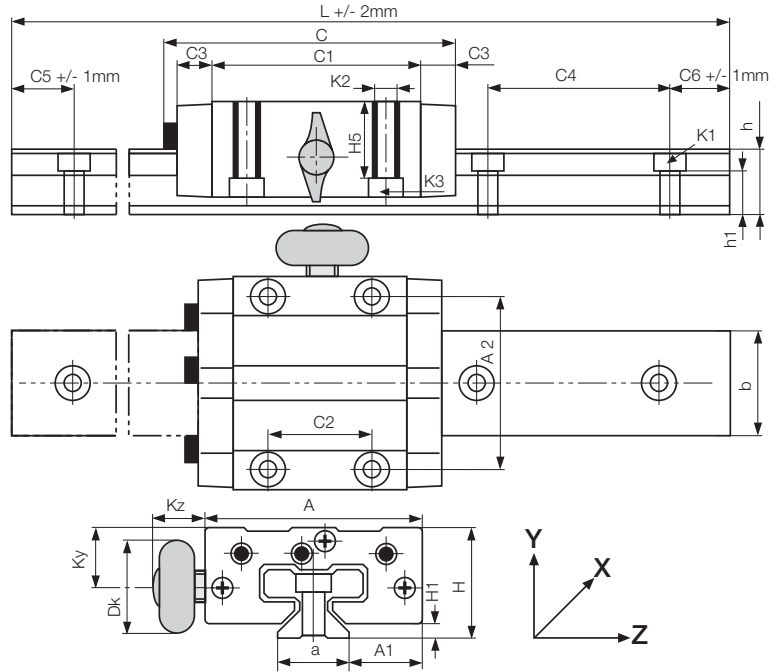

DryLin® T guide rails

Part No.	Weight (kg/m)	L max. (mm)	a -0.2 (mm)	C4 (mm)	C5 min. (mm)	C5 max. (mm)	C6 min. (mm)	C6 max. (mm)	h (mm)	h1 (mm)	K1 for Screw DIN 912 (mm)	b (mm)	ly (mm²)	lz (mm²)	Wby (mm²)	Wbz (mm²)
TS-01-15	0.6	3650	15	60	20	49.5	20	49.5	15.5	10.0	M 4	22	6440	4290	585	488
TS-01-20	1.0	3650	20	60	20	49.5	20	49.5	19.0	12.3	M 5	31	22570	11520	1456	1067
TS-01-25	1.3	3650	23	60	20	49.5	20	49.5	21.5	13.8	M 6	34	34700	19300	2041	1608
TS-01-30	1.9	3650	28	80	20	59.5	20	59.5	26.0	15.8	M 8	40	70040	40780	3502	2832

Order example: TS-01-15, 2000 for a guide rail TS-01-15 of 2m length

DryLin® T carriages

Part No.	Weight (kg)	H ±0.35 (mm)	A (mm)	C (mm)	A1 ±0.35 (mm)	A2 (mm)	C1 (mm)	C2 (mm)	C3 (mm)	H1 ±0.35 (mm)	H5 (mm)	K2 Thread	Torque Max. (Nm)	K3 for Screw DIN 912
TW-HKA-01-15	0.11	24	47	74	16.0	38	50	30	9	4.0	16.0	M 5	1.5	M 4
TW-HKA-01-20	0.19	30	63	87	21.5	53	61	40	10	5.0	19.8	M 6	2.5	M 5
TW-HKA-01-25	0.29	36	70	96	23.5	57	68	45	11	5.0	24.8	M 8	6.0	M 6
TW-HKA-01-30	0.50	42	90	109	31.0	72	79	52	12	6.5	27.0	M 10	15.0	M 8

DryLin® T - Carriages with manual clamping

Part No.	Size	Kz	Ky	Dk	Thread of the Clamp
TW-HKA-01-15	15	19.0	11.5	20.0	M6
TW-HKA-01-20	20	18.0	15.0	28.0	M8
TW-HKA-01-25	25	17.0	19.0	28.0	M8
TW-HKA-01-30	30	20.0	21.5	28.0	M8

TW-01-20 HKA, Lly for a guide carriage with manual clamping and floating bearing in y-direction. Floating offers 1mm extra clearance

This order example (TK-01-15-2-500 HKA) corresponds to a DryLin® T system of size 15 with 2 carriages, 500 mm rail length and manual clamping.

Structure – part no.

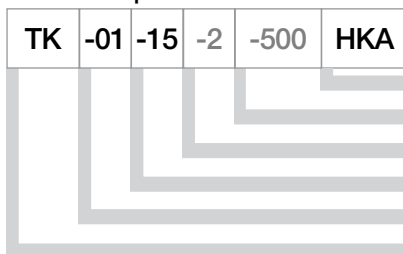

- Manual clamping
- Length of rail (mm)
- Number of carriages
- Size
- Type
- Complete set

DryLin® T Linear Guide Systems Clamping Elements and Manual Clamp

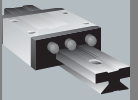

Special properties

- Compact clamping of high loads, for all sizes (15-30) holding strength 112 lbs
- Simple assembly

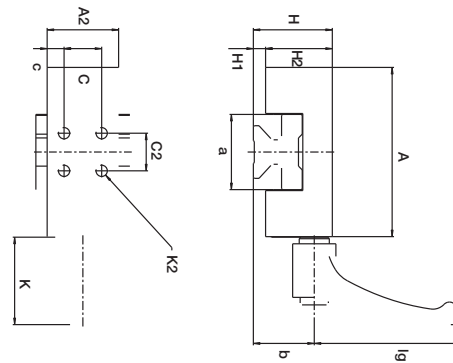

DryLin® T carriages with manual clamping

Part No.	A	a	A2	H	H1	H2	K2	C	C2	c	lg	b
TWBM-11-15	47	22	15	24	4	20	M4	15	15	4	44	18.9
TWBM-11-20	63	31	28	30	6	24	M5	15	15	6.5	44	23
TWBM-11-25	70	34	35	36	5	31	M6	20	20	7.5	63.6	26.2
TWBM-11-30	90	40	38	42	6.5	35.5	M6	20	20	9	78	32.4

DryLin® T manual clamp



Special properties

- Clamping of high loads, holding strength 112 lbf per clamp
- Brass clamp elements
- Same hole pattern as TW-01-25
- Removable handle

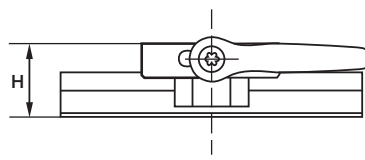
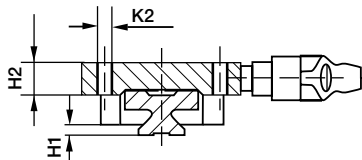
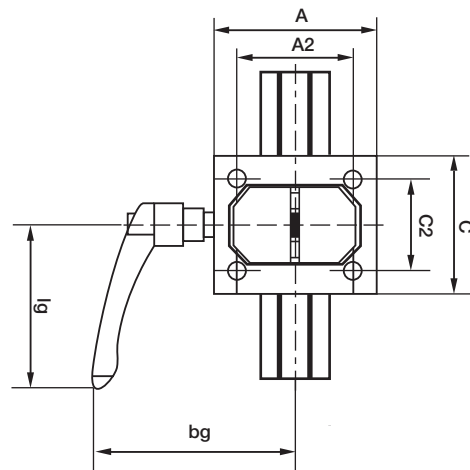

DryLin® T manual clamping

Part No.	A	A2	H	H1	H2	K2	C	C2	lg	bg
	[mm]	[mm]	[mm]	[mm]	[mm]		[mm]	[mm]	[mm]	[mm]
TWBM-01-25*	80	57	36	5	16	M8	68	45	80	99

*Only for guide rails TS-01-25

DryLin® T guide rail for TWBM

Part No.	Weight [kg/m]	L max. [mm]	a -0.2 [mm]	C4 [mm]	C5		C6		h	h1	K1 for Screw DIN 912	b [mm]	ly [mm ²]	lz [mm ²]	Wby [mm ²]	Wbz [mm ²]
					min.	max.	min.	max.								
TS-01-15	0.6	4,000	15	60	20	49	20	49	15.5	10.0	M4	22	6,440	4,290	585	488
TS-01-20	1.0	4,000	20	60	20	49	20	49	19.0	12.3	M5	31	22,570	11,520	1,456	1,067
TS-01-25	1.3	4,000	23	60	20	49	20	49	21.5	13.8	M6	34	34,700	19,300	2,041	1,608
TS-01-30	1.9	4,000	28	80	20	49	20	49	26.0	15.8	M8	40	70,040	40,780	3,502	2,832

For rails without mounting holes, please use part number suffix "S"

DryLin® T Linear
Guide Systems

PDF: www.igus.com/iglide-pdfs
CAD: www.igus.com/iglide-CAD
RoHS info: www.igus.com/RoHS



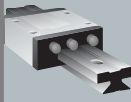

DryLin® T Linear Guide Systems Heavy Duty

DryLin® T Linear
Guide Systems

Telephone 1-800-521-2747
Fax 1-401-438-7270



- Linear guide carriage for extreme conditions (dirt, glue resins, wood chips, mud, etc.)
- iglide® J polymer sliding pads are mechanically fixed by metal end plates
- Dimensions equivalent to the TW-01 design and standard recirculating ball bearings.
- Non-adjustable version
- Same loading as -01 Series but with better shock resistance
- No charge for rails cut to standard C5/C6 tolerances

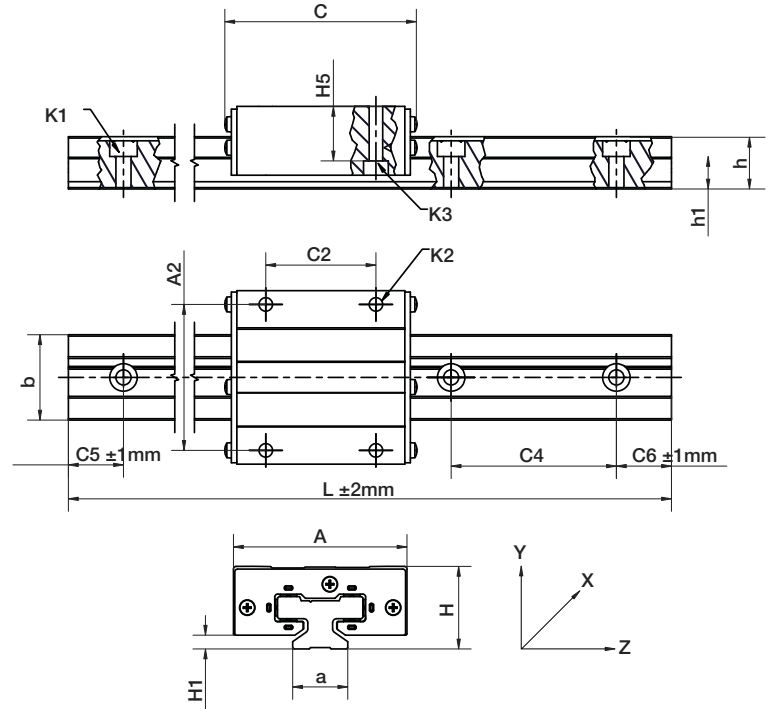

DryLin® T guide rails

Part No.	Weight [kg/m]	L max. [mm]	a -0.2 [mm]	C4 [mm]	C5		C6		h	h1	K1 for Screw DIN 912	b [mm]	ly [mm ²]	lz [mm ²]	Wby [mm ²]	Wbz [mm ²]
					min.	max.	min.	max.								
TS-01-20	1.0	3650	20	60	20	49	20	49	19.0	12.3	M 5	31	22,570	11,520	1,456	1,067
TS-01-25	1.3	3650	23	60	20	49	20	49	21.5	13.8	M 6	34	34,700	19,300	2,041	1,608
TS-01-30	1.9	3650	28	80	20	59	20	59	26.0	15.8	M 8	40	70,040	40,780	3,502	2,832

Order example: TS-01-20, 2000 for a guide rail TS-01-20 of 2 m length
For rails without mounting holes, please use part number suffix "S"

DryLin® T heavy duty carriages

Part No.	Weight (kg)	H ± 0.35 (mm)	H5 (mm)	A (mm)	C (mm)	A2 (mm)	C2 (mm)	H1 ± 0.35 (mm)	K2 (mm)	K3 (mm)
TW-02-25	0.29	36	24.8	70	77	57	45	5.0	M8	M6
TW-02-30	0.50	42	27.0	90	92	72	52	6.5	M10	M8

Floating bearing on request

DryLin® TK-02 complete system

Structure – part no.

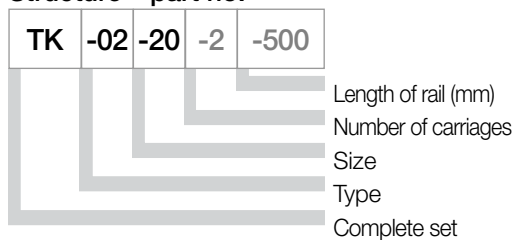

This order example (TW-02-20-2-500) corresponds to a complete DryLin® T Heavy Duty system of size 20 with 2 carriages 500 mm rail length.

Internet: <http://www.igus.com>
email: sales@igus.com
QuickSpec: <http://www.igus.com/iglide-quickspec>

DryLin® T Linear Guide Systems - Miniature

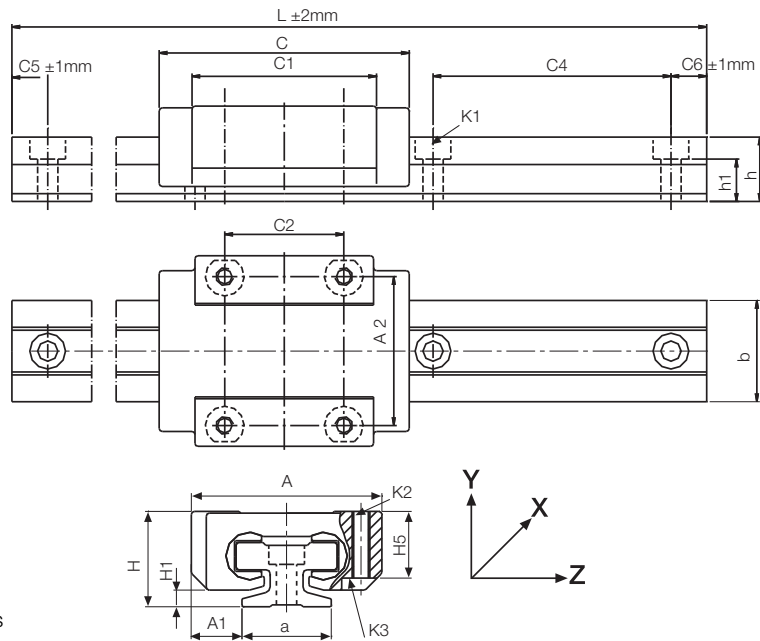
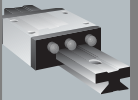

- Maintenance-free, dry operation
- 3 sizes
- Cast zinc chromated carriage
- iglide® J polymer sliding pads
- Hard anodized aluminum rails
- Small mounting height and width
- Resistant to corrosion
- Standard bore pattern symmetrical C5 = C6
- No charge for rails cut to standard C5/C6 tolerances

DryLin® T miniature rails

Part No.	Weight [kg/m]	L max. [mm]	a -0.2 [mm]	C4 [mm]	C5		C6		h	h1	K1 for Screw DIN 912	b [mm]	ly [mm²]	lz [mm²]	Wby [mm²]	Wbz [mm²]
					min.	max.	min.	max.								
TS-04-09	0.11	2000	9	20	5	14.5	5	14.5	6.3	4.6	M 2	9.6	252	169	52	49
TS-04-12	0.19	2000	12	25	5	19.5	5	19.5	8.6	5.9	M 3	13	856	574	132	120
TS-04-15	0.33	3000	15	40	10	29.5	10	29.5	10.8	7.0	M 3	17	2420	1410	285	239

DryLin® T miniature carriages

Part No.	Weight (g)	H ±0.2 (mm)	A ±0.2 (mm)	C ±0.3 (mm)	A1 ±0.35 (mm)	A2 (mm)	C1 (mm)	C2 (mm)	H1 ±0.35 (mm)	H5 (mm)	K2 Thread	Torque Max. (Nm)	K3 for Screw DIN 912
TW-04-09	17	10	20	29	5.5	15	18	13	1.7	7.2	M 2	25	(M 2)
TW-04-12	34	13	27	34	7.5	20	22	15	2.2	9.5	M 3	50	M2 (M 3)
TW-04-15	61	16	32	42	8.5	25	31	20	2.8	11	M 3	50	M2 (M 3)

Available from stock

Structure – part no.

TK	-04	-15	-2	-500
----	-----	-----	----	------

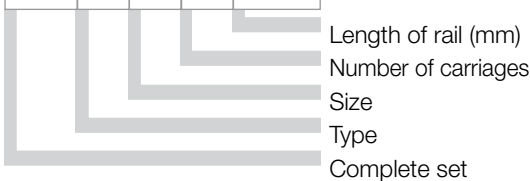

This order example (TK-04-15-2-500) corresponds to a complete DryLin® T miniature system of size 15 with 2 carriages 500 mm rail length. Order TK-04-15-2-500-LLY for a complete system with floating bearing in y-direction.

DryLin® T Linear Guide Systems

PDF: www.igus.com/iglide-pdfs
CAD: www.igus.com/iglide-CAD
RoHS info: www.igus.com/RoHS



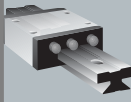

Adjusting the clearance: DryLin® T

DryLin® T is delivered ready for installation. Clearance of the carriage is adjusted at the factory. The preadjustment is determined by the acting forces on each individual system. If necessary, clearance of the DryLin® T linear guide system can be readjusted. This should always take place when there is no load on the carriage.

- 1** After removing the protective cover, loosen the locknuts Width across flats:
 - SW 5 for TW-01-15 and TW-01-20
 - SW 7 for TW-01-25 and TW-01-30
- 2** Adjust the bearing clearance for the 3 guide points with an Allen key – Allen key size:
 - 1.5 mm for TW-01-15 and TW-01-20
 - 2.0 mm for TW-01-25 and TW-01-30
- 3** Check the clearance of the carriage after adjusting the 3 levels. If it is sufficient, tighten the locknuts and put on the cover.
- 4** There is a danger that excessive reduction of the clearances can seize the sliding pads and that the clearance cannot be reset simply by loosening the adjustment screws. The sliding pads are then released by pressing the reset button on the opposite side. Press hard against the readjusting spring. You must have already loosened the respective adjustment screws. Use the correct size pin for this purpose:
 - 2.5 mm for TW-01-20 and TW-01-15
 - 3.0 mm for TW-01-25 and TW-01-30

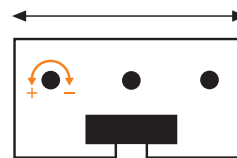

lateral guide:

- less clearance
- + more clearance

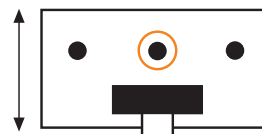

vertical guide left

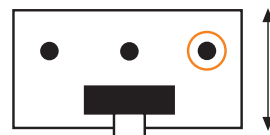

vertical guide right

Video instructions available at www.igus.com

Adjusting the clearance: DryLin® T Automatic

The DryLin® T Automatic series offers you an automatic adjustment of the clearance. A readjustment can take place automatically in steps of 0.1 mm. Springs tighten the regulating wedge immediately as soon as the clearance is bigger than 0.1 mm and the system is unloaded.

- 1** The system will be delivered with 3 keys which are already installed, and are necessary for mounting the carriage onto the rail. In case these keys are removed they need to be refitted into the openings and turned clockwise 90°.
- 2** After the carriage is on the rail, remove the keys by turning them anticlockwise 90° and pull out. The clearance will then be adjusted automatically.
- 3** You can remove the carriage at any time. In order to do so, simply plug the keys back into the carriage (see step 1).

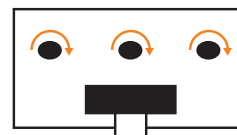

locked

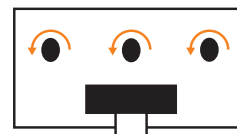

unlocked

DryLin® T Linear Guide Systems System Design

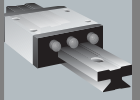

Example of DryLin® T Calculation

For the exact calculation of the Linear Guide System it is essential to find out whether the position of the forces is within the allowable limits, and if the gliding element where the highest forces occur is not overloaded. The calculation of the necessary driving force and the maximum speed allowed is important. Each mounting version requires a different formula for calculation. Factors concerning shocks and acceleration forces are not included in the calculation, therefore the maximum load and allowable load must be monitored.

Variables in the Calculation:

Fa	: Drive Force (lbs)
Fs	: Applied Mass Force (lbs)
Fy, Fz	: Bearing Load (lbs) in y or z direction (mm)
sx, sy, sz	: Distance of the mass force in y or z direction (mm)
ay, az	: Distance of the drive force in y or z direction (mm)
wx	: Distance between carriages on a rail (mm)
LX	: Constant from table (mm)
Zm	: Constant from table (mm)
Y0	: Constant from table (mm)
b	: Distance between guide rails (mm)
μ	: Coefficient of Friction, μ = 0 for static Loads μ = 0.2 for dynamic loads
ZW	: number of carriages per rail

Coefficients:

	1 Rail 1 Carriage	1 Rail 2 Carriages	2 Rails 3-4 Carriages
K₁	(ay+Y0)/Lx	(ay+Y0)/Wx	(ay+Y0)/Wx
K₂	(sy+Y0)/Lx	(sy+Y0)/Wx	(sy+Y0)/Wx
K₃	az/Lx	az/Wx	az/Wx
K₄	sx/Lx	sx/Wx	sx/Wx
K₅	sz/Lx	sz/Wx	sz/Wx
K₆	(sy+Y0)/Zm	(sy+Y0)/Zm	(sy+Y0)/b
K₇	sz/Zm	sz/Zm	(sz/b)-0.5

The Constant Values:

Part #	LX (mm)	ZM (mm)	Y0 (mm)
TW-01-15	29	16	11.5
TW-01-20	35	23	15.0
TW-01-25	41	25	19.0
TW-01-30	49	29	21.5

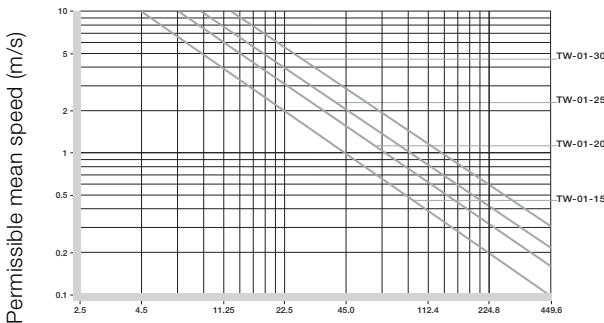

Centric bearing load (N)

Diagram for determining the maximum permissible speed for the calculated bearing load

Part No.	Fy max. lbs	Fz max. (N)
TW-01-15	450	2000
TW-01-20	830	3700
TW-01-25	1125	5000
TW-01-30	1575	7000

Maximum permissible load



Online Lifetime
Calculation
www.igus.com

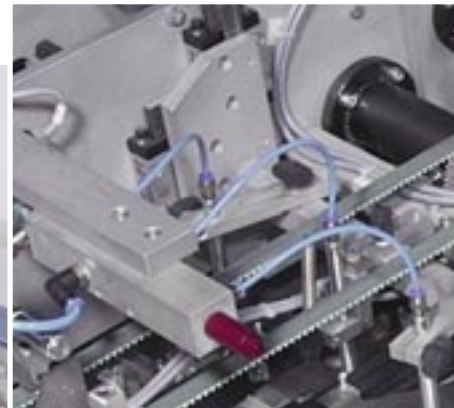

DryLin® T linear guide systems are used in these enveloping machines to guide a suction opener for envelopes. The guide system must have low clearance, be maintenance-free and not require any lubrication.

DryLin® T Linear
Guide Systems

PDF: www.igus.com/iglide-pdfs
CAD: www.igus.com/iglide-CAD
RoHS info: www.igus.com/RoHS



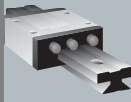

Recommended Procedure:

1st Step

Select the mounting version:

- horizontal
 - 1 rail and 1 carriage
 - 1 rail and 2 carriages
 - 2 rails and 4 carriages

2nd Step

Check to see whether the maximum distances of the applied forces are within the permissible values (see Maximum permissible distances.)

Maximum permissible distances between acting forces:

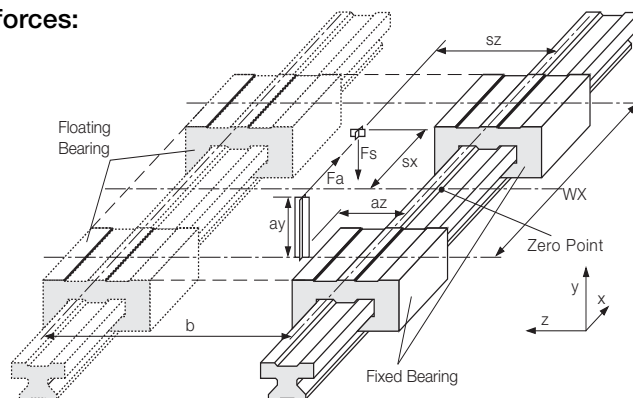
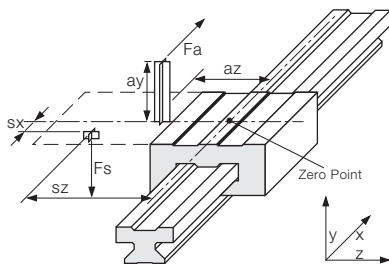

Variation: 1 Rail, 1 Carriage

$s_y + s_z$	<	$2 L_x - Y_0$
$a_y + a_z$	<	$2 L_x - Y_0$
s_y	<	$5 Z_m$
s_z	<	$5 Z_m$

Variation: 1 Rail, 2 Carriages

Variation: 2 Rails, 4 Carriages

$s_y + s_z$	<	$2 w_x - Y_0$
$a_y + a_z$	<	$2 w_x - Y_0$

3rd Step:

Calculate the necessary drive force

3.1 Center of gravity in x and z direction inside the carriage(s)

$$F_{a1} = \frac{\mu}{1 - 2\mu K_3} \cdot F_s$$

3.2 Center of gravity in z direction outside of the carriage(s)

$$F_{a2} = \frac{2\mu K_7}{1 - 2\mu K_3} \cdot F_s$$

3.3 Center of gravity in x direction outside of the carriage(s)

$$F_{a3} = \frac{2\mu K_4}{1 - 2\mu K_3 - 2\mu K_1} \cdot F_s$$

If the position of the center of gravity is not specified: $F_a = \text{MAX} (F_{a1}, F_{a2}, F_{a3})$

4th Step:

Calculate the maximum bearing load

4.1 Maximum bearing load in the y direction

$$F_{y \max} = \frac{2F_s}{Z_w} \left(\frac{2K_4}{Z_w} + 0,5 \right) \cdot \left(K_7 + 0,5 \right) + \frac{2F_a K_1}{Z_w^2}$$

4.2 Maximum bearing load in the z direction

$$F_{z \max} = \frac{4F_a K_3}{Z_w^2}$$

5th Step:

Check calculated load for both y and z with table on page 26.15 - Maximum permissible load for $F_{y \max}$ & $F_{z \max}$. This table illustrates the maximum permissible load on a single gliding element from the DryLin® T carriage. Evaluating the maximum load on a single gliding element establishes a safety factor for the linear system.

►Page 26.15

6th Step:

Determine the maximum permissible speed for the calculated load from Step No. 4

►Page 26.15

DryLin® T Linear Guide Systems - Mounting Version - Lateral

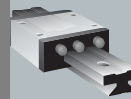

Recommended Procedure:

1st Step

Select the mounting version:

- **side-mounting**
 - 1 rail and 1 carriage
 - 1 rail and 2 carriages
 - 2 rails and 4 carriages



Online Lifetime Calculation
www.igus.com

2nd Step

Check to see whether the maximum distances of the applied forces are within the permissible values (see Maximum permissible distances.)

Maximum permissible distances between acting forces:

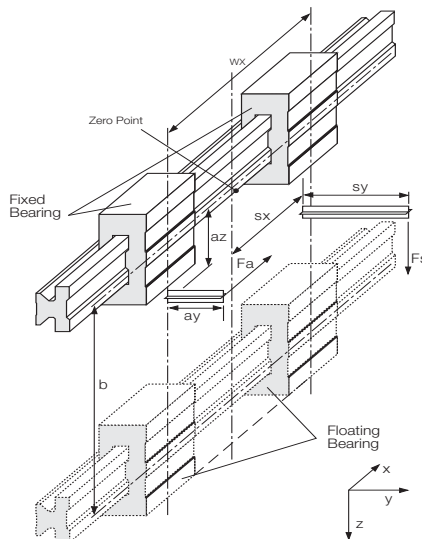
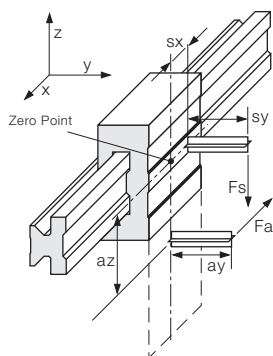

Variation: 1 Rail, 1 Carriage

$sy + sz$	$<$	$2 Lx - Y0$
$ay + az$	$<$	$2 Lx - Y0$
sy	$<$	$5 Zm$
sz	$<$	$5 Zm$

Variation: 1 Rail, 2 Carriages Variation: 2 Rails, 4 Carriages

$sy + sz$	$<$	$2 wx - Y0$
$ay + az$	$<$	$2 wx - Y0$

3rd Step:

Calculate the necessary drive force

First, two calculations must be made:

$$Fa1 = \frac{(1+2K_6)\mu}{1-2\mu K_1} \cdot Fs \qquad Fa2 = \frac{(2K_4+2K_6)\mu}{1-2\mu K_1-2\mu K_3} \cdot Fs$$

The drive force Fa corresponds to the calculated maximum value $Fa = \text{MAX}(Fa1, Fa2)$

4th Step:

Calculate the maximum bearing load

4.1 Maximum bearing load in the y direction

$$Fy \max = \frac{Fs K_6}{Zw} + \frac{2Fa K_1}{Zw^2}$$

4.2 Maximum bearing load in the z direction

$$Fz \max = \frac{2Fs}{Zw} \left(\frac{2K_4}{Zw} + 0.5 \right) + \frac{4Fa K_3}{Zw^2}$$

5th Step:

Check calculated load for both y and z with table on page 26.15 - Maximum permissible load for $Fy \max$ & $Fz \max$. This table illustrates the maximum permissible load on a single gliding element from the DryLin® T carriage. Evaluating the maximum load on a single gliding element establishes a safety factor for the linear system.

►Page 26.15

6th Step:

Determine the maximum permissible speed for the calculated load from Step No. 4

►Page 26.15



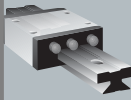

Recommended Procedure:

1st Step

Select the mounting version:

- vertical
 - 1 rail and 1 carriage
 - 1 rail and 2 carriages
 - 2 rails and 4 carriages

2nd Step

Check to see whether the maximum distances of the applied forces are within the permissible values (see Maximum permissible distances.)

Maximum permissible distances between acting forces:

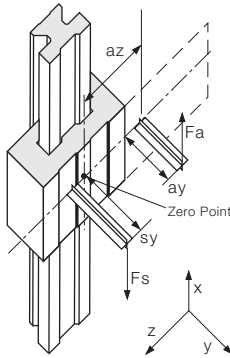

Variation: 1 Rail, 1 Carriage

$s_y + s_z$	<	$2 L_x - Y_0$
$a_y + a_z$	<	$2 L_x - Y_0$
s_y	<	$5 Z_m$
s_z	<	$5 Z_m$

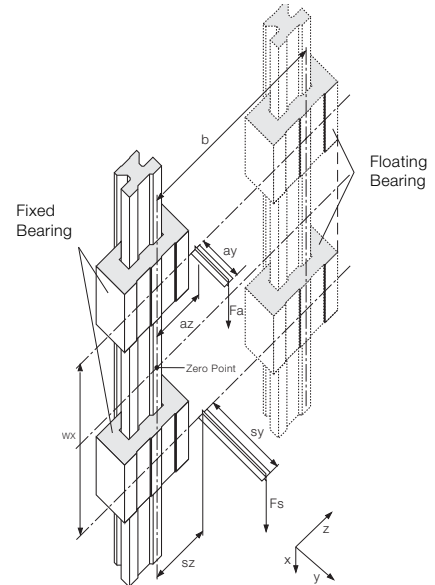

Variation: 1 Rail, 2 Carriages

Variation: 2 Rails, 4 Carriages

$s_y + s_z$	<	$2 w_x - Y_0$
$a_y + a_z$	<	$2 w_x - Y_0$

3rd Step:

Calculate the necessary drive force

First, four calculations must be made:

$$F_{a1} = \frac{2\mu (s_z + s_y + Y_0) - w_x}{2\mu (a_z + a_y + Y_0) - w_x} \cdot F_s$$

$$F_{a3} = \frac{2\mu (s_z - s_y - Y_0) - w_x}{2\mu (a_z - a_y - Y_0) - w_x} \cdot F_s$$

$$F_{a2} = \frac{2\mu (-s_z + s_y + Y_0) - w_x}{2\mu (-a_z + a_y + Y_0) - w_x} \cdot F_s$$

$$F_{a4} = \frac{2\mu (s_z + s_y + Y_0) + w_x}{2\mu (a_z + a_y + Y_0) + w_x} \cdot F_s$$

The drive force F_a corresponds to the calculated maximum value $F_a = \text{MAX} (F_{a1}, F_{a2}, F_{a3}, F_{a4})$

4th Step:

Calculate the maximum bearing load

4.1 Maximum bearing load in the y direction

$$F_{y \max} = \left| F_a \frac{a_y + Y_0}{w_x} - F_s K_2 \right| \cdot \frac{2}{Z W^2}$$

4.2 Maximum bearing load in the z direction

$$F_{z \max} = \left| F_a \frac{a_z}{w_x} - F_s K_5 \right| \cdot \frac{4}{Z W^2}$$

5th Step:

Check calculated load for both y and z with table on page 26.15 - Maximum permissible load for $F_{y \max}$ & $F_{z \max}$. This table illustrates the maximum permissible load on a single gliding element from the DryLin® T carriage. Evaluating the maximum load on a single gliding element establishes a safety factor for the linear system.

►Page 26.15

6th Step:

Determine the maximum permissible speed for the calculated load from Step No. 4

►Page 26.15

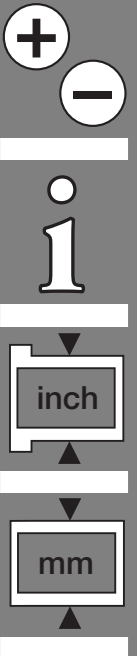
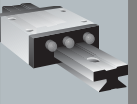

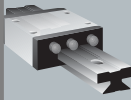

DryLin® W Linear Guide Systems

DryLin® T Linear
Guide Systems

Telephone 1-800-521-2747
Fax 1-401-438-7270

Internet: <http://www.igus.com>
email: sales@igus.com
QuickSpec: <http://www.igus.com/iglide-quickspec>

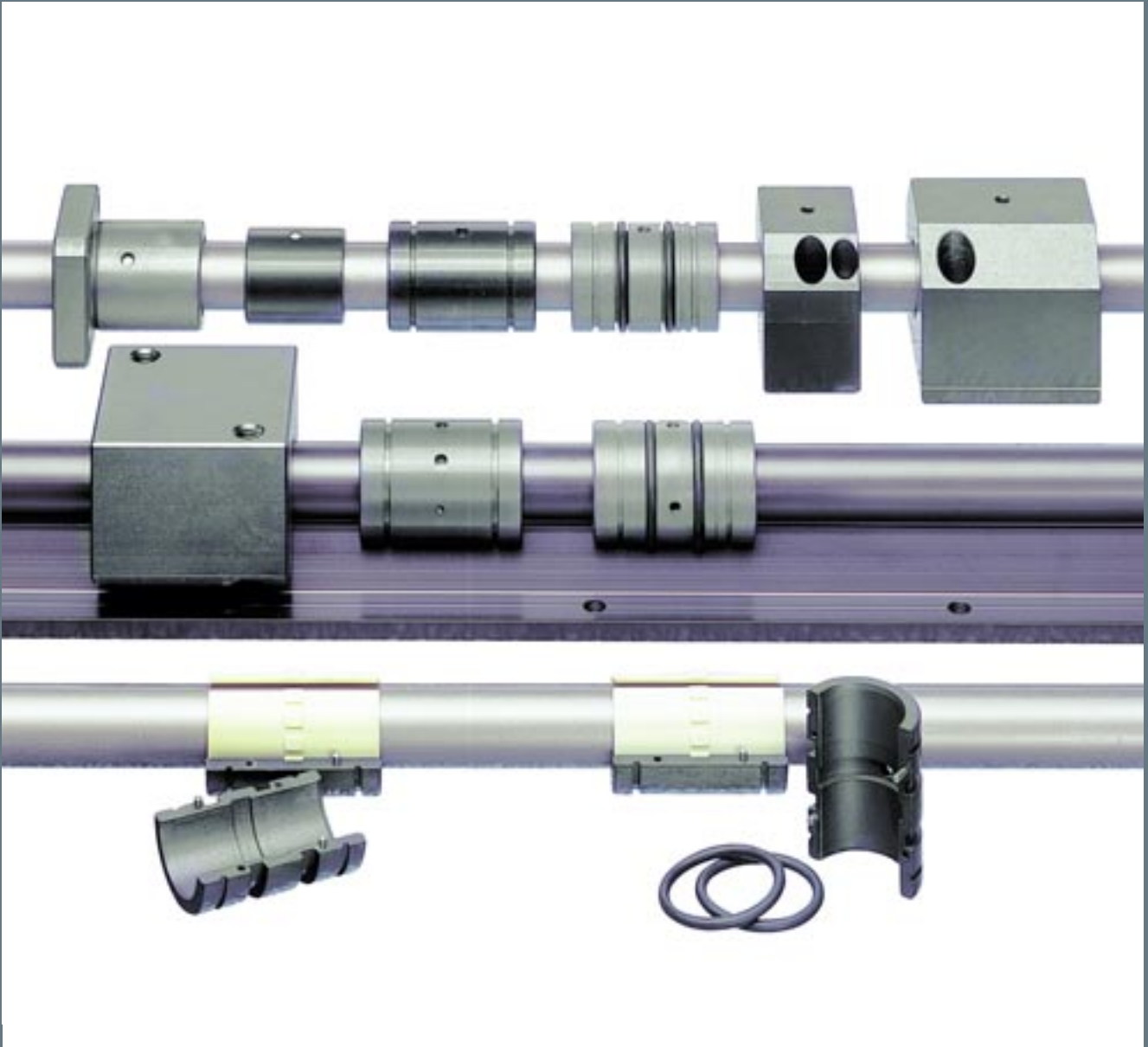

DryLin[®] R Linear Plain Bearings for Round Shafts



DryLin® R Linear Plain Bearing

Product Range

- Inner diameters:
Inch sizes from 1/4 - 2 in.
Metric sizes from 6 - 60 mm
- up to 30 bearing types for every diameter

Special Features

Clean-Room Cleanroom certified - IPA Fraunhofer

ESD ESD compatible (electrostatic discharge)

RoHS Free of toxins - RoHS 2002/95/EC

Technical Data

Liners: Maintenance-free

Materials:

- iglide® J
- iglide® J200
- iglide® T500

Max. speed:

up to 49 ft/min
(15 m/s)

Shaft materials:

- Anodized aluminum
- Case-hardened steel
- Stainless steel
- Cold-rolled steel
- Hard chrome-plated
- Carbon fiber

Temperatures

iglide® J:

-40°F to +194°F

iglide® J200:

-40°F to +194°F

iglide® T500:

-148°F to +482°F

Also available as driven systems



HTS Page 30.17

DryLin® R linear plain bearings, made from solid polymers, are dimensionally equivalent to standard ball bearings. They are made entirely of wear resistant iglide® materials offering technical benefits as well as a clear price advantage.



DryLin® R: Linear Plain Bearings

DryLin® R is dimensionally interchangeable with linear ball bearings, but offers cleaner, more cost-effective results even in harsh environments. The standard RJUI/RJUM bearing consists of an iglide® J liner slip-fit into an aluminum housing. The unique grooved design of the J liner minimizes clearance, is suitable for use in extremely wet and dirty environments, and is easily replaceable. Dimensionally interchangeable all-polymer parts RJI/RJM are also available for cost-savings, weight reduction, and other technical advantages. Both parts are secured with retaining clips, as are ball bearings. DryLin R guides may also be used with the high temperature, chemically resistant T500 (TUI/TUM) liners for extreme applications.

Advantages of DryLin® R

- Self-lubricating
- Maintenance-free
- Can be used in extreme dirt conditions
- Can be used underwater or in washdown conditions
- Replaceable liner
- Dimensionally interchangeable with standard recirculating ball bearings
- Vibration dampening
- No seals or wipers needed
- Compensation for shaft misalignment (O3 series)



Standard aluminum



Standard stainless steel



Standard solid plastic

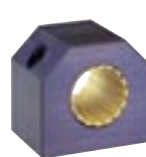

Pillow block



Flange pillow block



Quad block



DryLin® R can be used in extreme dirt conditions

DryLin® R Linear Plain Bearing Material Table



General Properties	Unit	iglide® J	iglide® T500	iglide® J200 (Available in some sizes)	Testing Method
Density	g/cm ³	1.49	1.44	1.72	
Color		Yellow	Black	Dark grey	
Max. moisture absorption at 73°F/50% r. F.	% weight	0.3	0.1	0.2	DIN 53495
Max. moisture absorption at 73°F	% weight	1.3	0.5	0.7	
Coefficient of sliding friction, dynamic against steel	μ	0.06 - 0.18	0.09 - 0.27	0.11 - 0.17	
P x V value, max. (dry)	psi x fpm	9,700	37,700	8,600	

Mechanical Properties

Modulus of elasticity	PSI	398,090	1,174,806	406,105	DIN 53457
Tensile strength at 68°F	PSI	10,587	24,656	8,412	DIN 53452
Compressive strength	PSI	8,702	14,504	n.d.	
Permissible static surface pressure (68°F)	PSI	5,076	21,755	3,335	
Shore D hardness		74	85	70	DIN 53505

Physical and Thermal Properties

Max. long term application temperature	°F	194	482	194	
Max. short term application temperature	°F	248	599	248	
Min. application temperature	°F	-58	-148	-58	
Thermal conductivity	W/m x K	0.25	0.6	0.24	ASTM C 177
Coefficient of thermal expansion (at 68°C)	K ⁻¹ x 10 ⁻⁵	10	5	8	DIN 53752

Electrical Properties

Specific volume resistance	Ωcm	> 10 ¹³	< 10 ⁵	> 10 ⁸	DIN IEC 93
Surface resistance	Ω	> 10 ¹²	< 10 ³	> 10 ⁸	DIN 53482

Table 24.1: Material Data

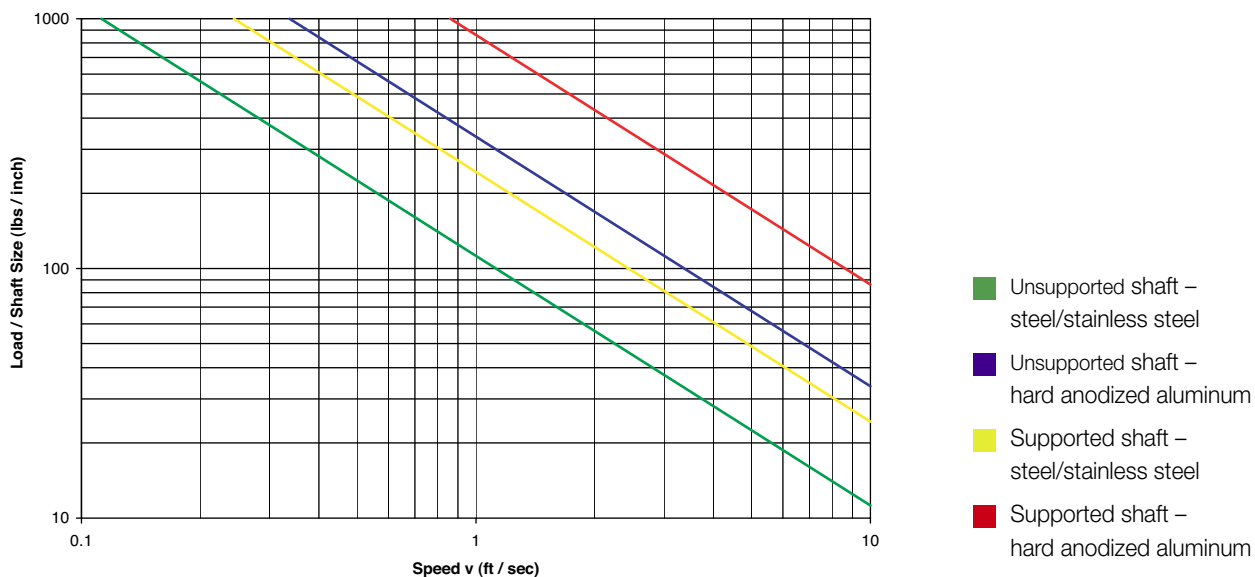



DryLin® S: Hard-Anodized Shafting

Although DryLin® R works well with various steel shafts, DryLin® S hard-anodized aluminum shafting was specifically developed as the optimal sliding surface for DryLin® R when using our standard iglide® J/J200 liner material. This combination achieves the lowest frictional properties, and reduces wear by up to 50% versus steel shafting — not to mention being very lightweight and extremely cost-effective.

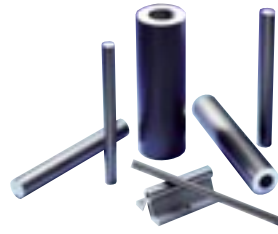

DryLin® R
Linear Guide Systems

Telephone 1-800-521-2747
Fax 1-401-438-7270

Internet: <http://www.igus.com>
email: sales@igus.com
QuickSpec: <http://www.igus.com/iglide-quickspec>

The iglide® J material

iglide® J material gliding on different surface materials achieved the best results in our tests. Comprehensive laboratory tests showed that iglide® J is by far the most suitable polymer material for linear motion applications. Special Characteristics of iglide® J:

- Lowest coefficient of friction on all materials
- Very low abrasion values during dry operation
- Excellent wear resistance
- Maintenance free dry operation
- Vibration dampening
- Very low moisture absorption
- Recommended for all shaft materials

The iglide® T500 material

iglide® T500 is defined by its combination of high temperature resistance with compressive strength, along with high resistance to chemicals. iglide® T500 achieves the best wear results with stainless steel and chrome plated steel shafts. Special characteristics:

- Temperature resistant from -148°F to +482°F in continuous operation
- Universal resistance to chemicals
- High compressive strength
- Very low moisture absorption
- Great wear resistance through the entire temperature range

iglide® J against various shaft materials

Wear

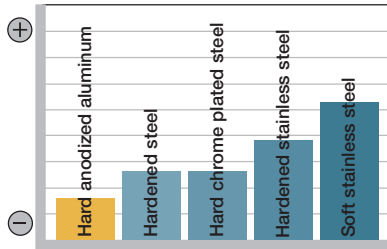

Coefficient of friction

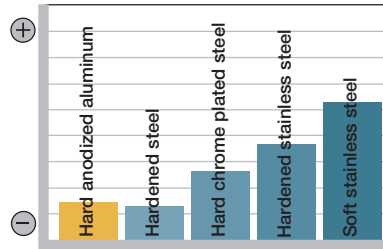

Corrosion

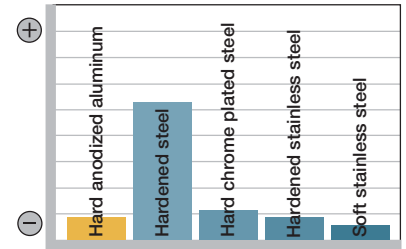

Weight

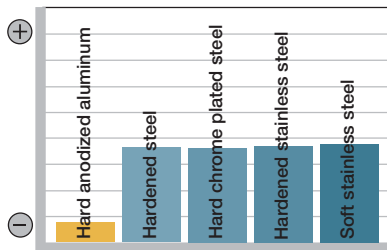

Costs

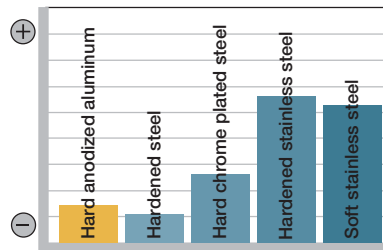

Chemical resistance

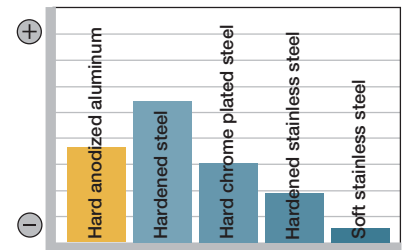

Recommended Shafting for DryLin® R

Size in inches	Class "L" Tolerance	Size in mm	h9
1/4"	.249"/.250"	6	6.000/5.988
3/8"	.374"/.375"	8	8.000/7.988
1/2"	.499"/.500"	10	10.000/9.988
5/8"	.624"/.625"	12	12.000/11.988
3/4"	.749"/.750"	16	16.000/15.988
1"	.999"/1.000"	20	20.000/19.988
1 1/4"	1.249"/1.250"	25	25.000/24.988
1 1/2"	1.499"/1.500"	30	30.000/29.987
2"	1.999"/2.000"	40	40.000/39.987
		50	50.000/49.984



DryLin® high-temperature bearings made of iglide® T500 are used to support the sealing bar in this packaging machine. The TUM liners run without lubrication at temperatures of around 266°F, allowing a class leading output of 90 cycles/min.



Chemical Resistance

iglide® J is resistant to weak acids, diluted lyes and to fuels and all types of lubricants. Even the frequent chemical washdowns of machines in the food industry are not a problem for DryLin® linear plain bearings.

iglide® T500 liners were developed specifically for chemical resistance and high temperature applications. T500 liners run particularly well when combined with stainless steel shafts, which are also recommended for chemical resistance.

Medium	iglide® J	iglide® T500
Alcohol	Resistant	Resistant
Chlorinated hydrocarbons	Resistant	Resistant
Ester	Not Resistant	Resistant
Greases, oils	Resistant	Resistant
Ketones	Conditionally Resistant	Resistant
Fuels	Resistant	Resistant
Weak acids	Conditionally Resistant	Resistant
Strong acids	Not Resistant	Conditionally Resistant
Weak lyes	Resistant	Resistant
Strong lyes	Resistant	Resistant
Sea water	Resistant	Resistant

Chemical resistance of iglide® J and iglide® T500

Corrosion Behavior

The low moisture absorption of iglide® J and T500 allows design in underwater areas. With the use of stainless steel shafts or anodized aluminum, a corrosion resistant guide results. Anodized aluminum is resistant to chemically neutral materials in the PH range 5 to 8. For special applications it is recommended to test coated aluminum sample parts to examine results prior to their use.

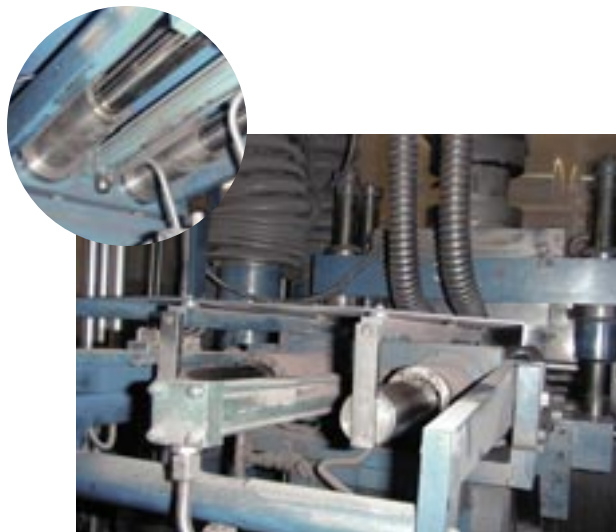

Stick-Slip Behavior

Stick-slip occurs when there is intermittent movement between two sliding partners. The stop and go movement is caused by frequent changes from static to dynamic friction.

The coefficients of static and sliding friction are close enough to each other for iglide® J that the danger of stick-slip behavior is very low.

	Coefficient of Static Friction	Coefficient of Dynamic Friction
J/Cold Rolled Steel	0.16	0.13

Coefficients of friction

Structure of the DryLin® R Part Numbers

The part numbers of the DryLin® R Linear bearings are designated according to the following system

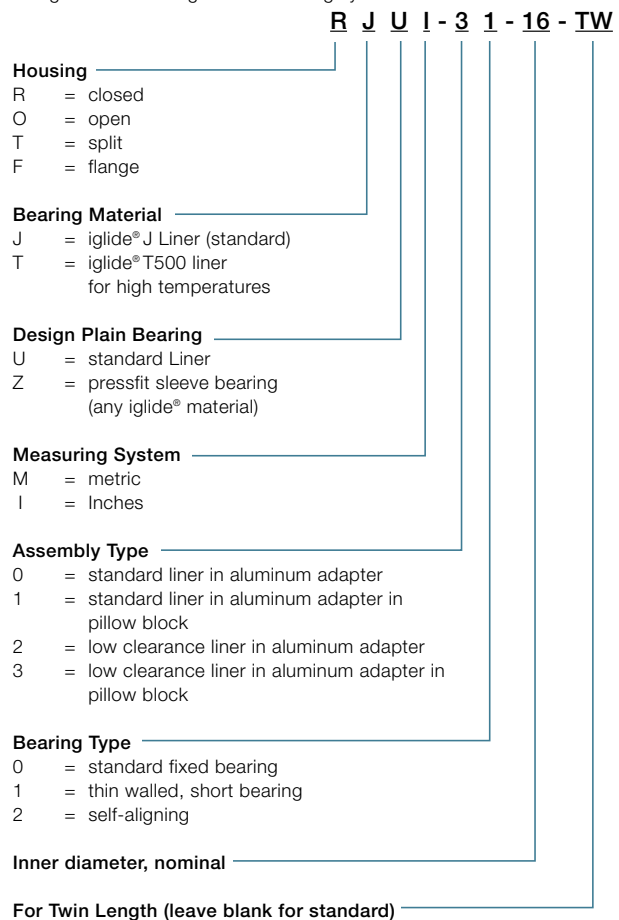

inch

mm



The Expert System 2.0

The Online Expert System (www.igus.com) enables the user to quickly and confidently determine the suitability of one or all DryLin systems in a particular application, and is able to calculate the following:

- Bearing lifetime in miles or kilometers
- The necessary drive force
- The maximum permissible continuous speed
- Bearing wear and the theoretical clearance

The system is able to determine proper functionality, and provides warning signals in order for the user to optimize the design. Information with regards to drive force, center-of-gravity, and required lifetime are also given.

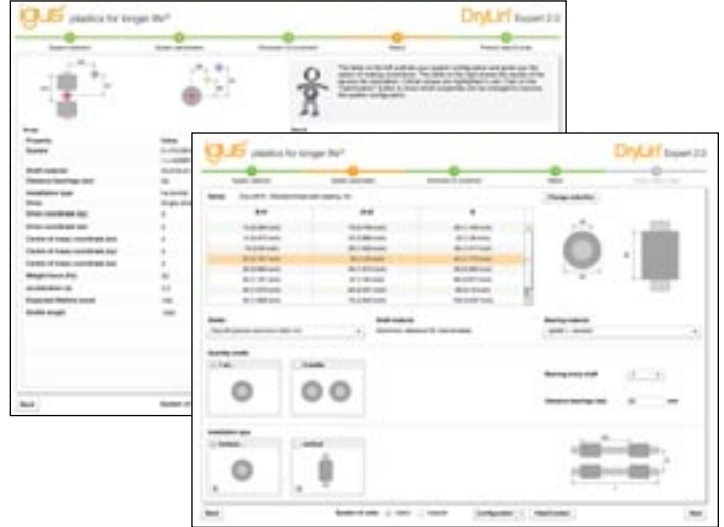

Dirt, Dust, Fibers

The patented design of the bearing surface using individual slide pads connected by thin film sections, provides performance benefits for dirty environments. For most ball bearing systems, the use of wiper or seals is recommended to prevent dirt accumulation. No other system has the design benefits for use in dust, fibers, and coarse dirt as DryLin®

Dirt, even if it becomes wet on the shaft, is wiped away by the individual glide pads and is moved into the contact-free areas. The glide sections of the DryLin® bearings then slide on the shaft that has been cleared of all contaminants.



DryLin® R provides reliability in applications where contaminants are prevalent



DryLin® R linear bearings in a safety door

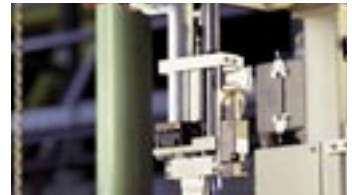

DryLin® R bearings in a retrieval robot with speeds up to 1574 fpm

Split Linear Bearings

Applications that operate on the edge of technical feasibility or in extremely harsh environments are characterized by the frequent replacement of the linear bearings. In many cases, service life can be multiplied many times by DryLin®. However, in extreme applications replacement of the bearings may be necessary even with DryLin®.

DryLin® linear bearings can contribute to considerable cost reductions in such cases, as only the bearings liner made of plastics has to be replaced. This often means a reduction of more than 90% in replacement part costs. The iglide® J liner can be replaced, while a ball-bearing cage cannot.

The DryLin® range of split adapters offers even greater cost savings. Shafts no longer need to be removed from the housing. The two shells of the adapter can be opened very easily. The high-performance plastic bearing inside is split and can easily be pulled off the shaft. Clip a new bearing over the shaft, put the two adapter halves together, install - done!

With this product line of split DryLin® bearings, installation times can be reduced to a minimum.



The DryLin® liner can be pushed easily onto the shaft



Then the adapter is fitted over the liner



Installation is simple and reduces downtime and maintenance costs



Eccentric Forces

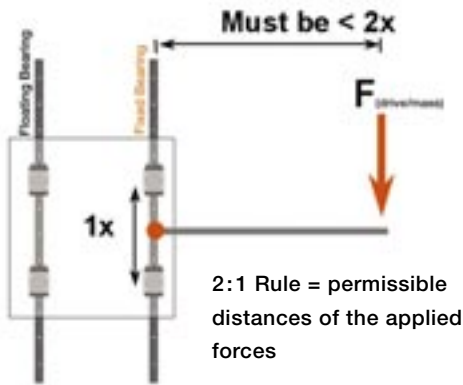

The 2:1 Rule

When using linear plain bearings it is important to ensure that the acting forces follow the 2:1 Rule (see drawing). If either the load or the drive force (F) is greater than twice the bearing length (1X), then a binding or interrupted motion may occur.

If the location of the drive force or load cannot be changed, simply increase the distance between the bearings, or create a counterbalance to move the center-of-gravity back within the 2 to 1 ratio.



Online Lifetime Calculation
www.igus.com

Fixed and Floating Bearing Mounting Instructions

When using systems with 2 parallel rails, one side must be designated as the “fixed” rail, and the opposite side as the “floating” rail.

Why use floating bearings?

- Promotes smooth gliding performance and maximizes bearing life
- Prevents binding caused by parallelism and angle errors
- Decreases necessary drive force and wear by minimizing friction-forces
- Enhances the precision of the system over the bearings' lifetime.
- Reduce assembly time and cost

Fixed Bearings

The “fixed” bearing rail should be positioned closest to the drive force. This rail will determine the precision of the system; no system should contain more than two “fixed” bearings.

Floating/Self-Aligning Bearings

The “floating” rail should be the rail located furthest from the drive force. It is to act only as a guide, and will compensate for any misalignments or angle errors in the system ensuring proper functionality.

Mounting Surfaces

The mounting surfaces for rails and bearings should have a very flat surface (e.g milled surface) in order to enhance performance. Variations in these surfaces may be compensated for by using floating bearings.

DryLin® R - Mounting Instructions

DryLin® R linear plain bearings in the 03 Design Series are self-aligning and offer great advantages in applications with parallel shafts. They are able to compensate for alignment and parallelism errors and should be used on the shaft located furthest from the drive mechanism.

The design provides a raised spherical area on the outer diameter of the aluminum adapter for self-alignment. Load capacity is the same as the fixed version.

Even in unfavorable edge-load conditions, the load is supported by the entire projected surface

In order to compensate for parallelism errors between two shafts, the outer diameter is designed to be smaller than the

housing bore diameter by 0.2 - 0.3 mm (depending on the size). With the use of mounted O-rings, these bearings have an elastic bearing seat.

Compensation for angle errors

Series RJUI/RJUM/OJUI/OJUM-03	±0.5°
Series RJUM-06-LL/OJUM-06-LL	±3.5°

Compensation of parallelism errors

Series RJUI/RJUM/OJUI/OJUM-03	±0.1 mm (.004")
Series RJUM-06-LL/OJUM-06-LL	±3 mm (.12")

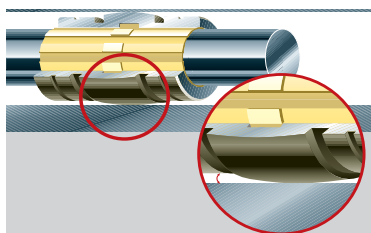

The spherical DryLin® adapters can compensate for alignment errors. A hard-anodization protects the aluminum adapter from wear.

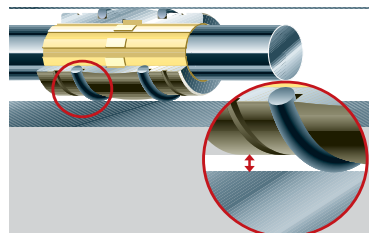

With built in clearances and the use of O-rings, the self-aligning DryLin® R bearings of the 03 Design Series can compensate for parallelism errors.



The self-aligning DryLin® R bearings of the 06 LL design series can compensate parallelism errors up to ± .12" (3mm).





DryLin® R
Linear Guide Systems

Telephone 1-800-521-2747
1-401-438-7270
Fax

Internet: <http://www.igus.com>
email: sales@igus.com
QuickSpec: <http://www.igus.com/iglide-quickspec>

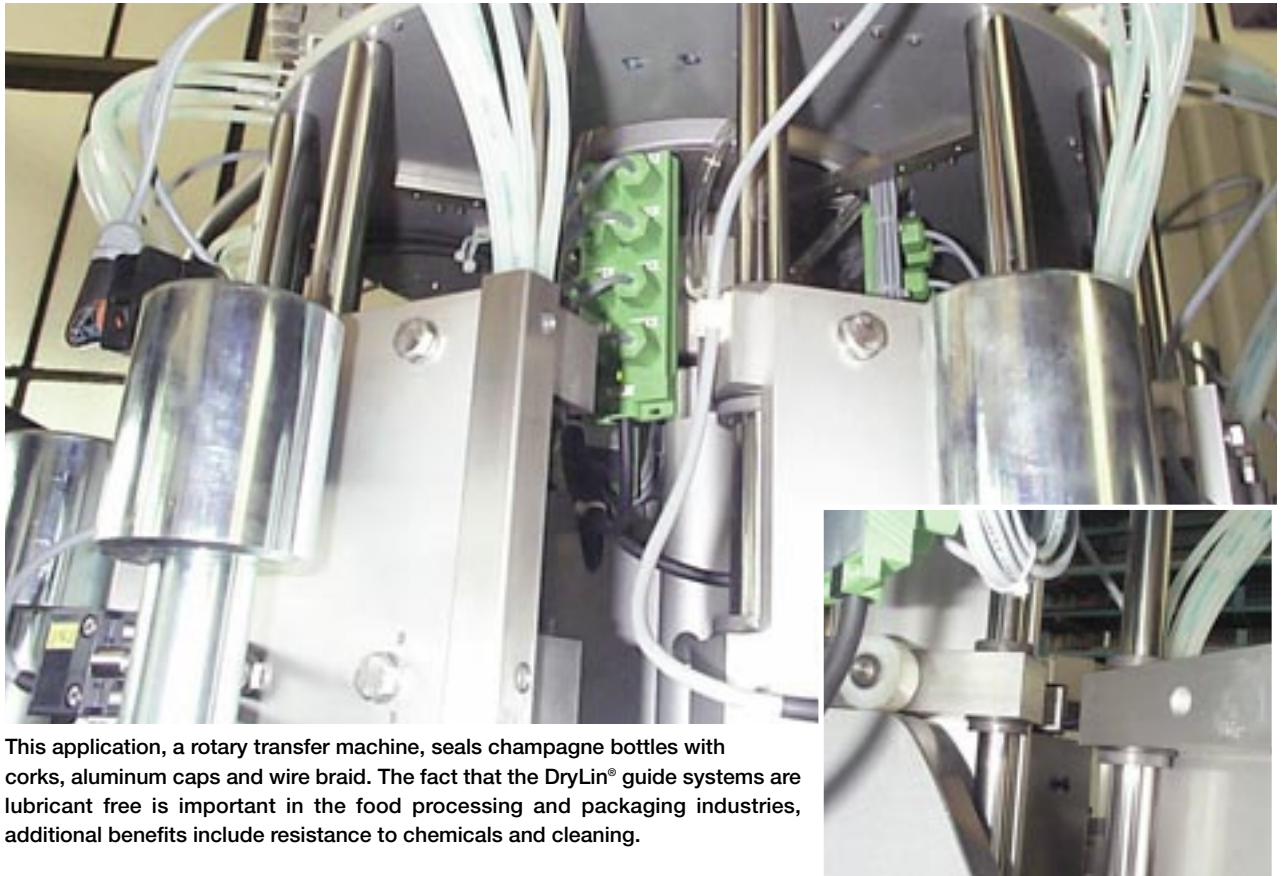

This application, a rotary transfer machine, seals champagne bottles with corks, aluminum caps and wire braid. The fact that the DryLin® guide systems are lubricant free is important in the food processing and packaging industries, additional benefits include resistance to chemicals and cleaning.



This application from the food industry transfers breads and pastries from one conveyor to the next. Lubrication is totally prohibited due to food contact. Another reason for using the DryLin® R linear plain bearings is the resistance to corrosive cleaning agents. Additional benefits include the reduced design space required by the iglide® J bearings and the excellent corrosion resistance.

DryLin® R - Liner, inch

JUI-01, Standard

JUI-20, Low Clearance

TUI-01, High Temp



Special Properties

- Very low coefficient of friction while running dry
- Very high wear resistance
- Maintenance-free
- Vibration dampening
- Very low moisture absorption
- High chemical resistance
- Suitable for rotating, oscillating and linear movements

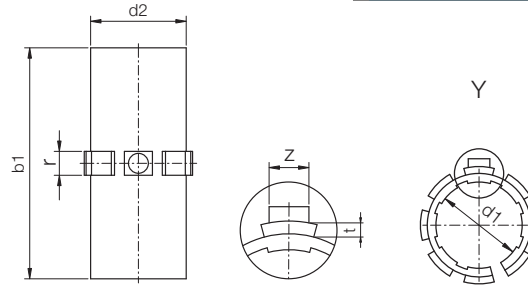

Part No.	Nominal Size	Tolerance*	d2	b1	r -0.004 -0.008	t -0.004	z -0.020
----------	--------------	------------	----	----	-----------------------	-------------	-------------

Standard Clearance

JUI-01-06	3/8	.0016-.0024	0.4684	0.846	.1250	.0311	.0866
JUI-01-08	1/2	.0016-.0024	0.5934	1.220	.1250	.0391	.1024
JUI-01-10	5/8	.0016-.0024	0.7184	1.460	.1406	.0391	.1181
JUI-01-12	3/4	.0016-.0024	0.8747	1.575	.1875	.0391	.1339
JUI-01-16	1	.0016-.0024	1.1247	2.205	.1875	.0391	.1496
JUI-01-20	1 1/4	.0020-.0032	1.4058	2.573	.1875	.0391	.1496
JUI-01-24	1 1/2	.0020-.0032	1.6558	2.953	.2500	.0625	.1811
JUI-01-32	2	.0024-.0040	2.1871	3.937	.2813	.0625	.2280



JUI-01-XX

Material: iglide® J
Temp. range: -40°F to +194°F
Best Shaft Material: DryLin® AWI hard anodized aluminum, case hardened steel, 300 series stainless

Low Clearance

JUI-20-06	3/8	.0008-.0012	0.4684	0.846	.1250	.0311	.0866
JUI-20-08	1/2	.0008-.0012	0.5934	1.220	.1250	.0391	.1024
JUI-20-10	5/8	.0008-.0012	0.7184	1.460	.1406	.0391	.1181
JUI-20-12	3/4	.0008-.0012	0.8747	1.575	.1875	.0391	.1339
JUI-20-16	1	.0008-.0012	1.1247	2.205	.1875	.0391	.1496
JUI-20-20	1 1/4	.0010-.0016	1.4058	2.573	.1875	.0391	.1496
JUI-20-24	1 1/2	.0010-.0016	1.6558	2.953	.2500	.0625	.1811
JUI-20-32	2	.0012-.0020	2.1871	3.937	.2813	.0625	.2280



JUI-20-XX

Material: iglide® J
Temp. range: -40°F to +194°F
Best Shaft Material: DryLin® AWI hard anodized aluminum, case hardened steel, 300 series stainless

High Temperature

TUI-01-08	1/2	.0016-.0024	0.5934	1.220	.1250	.0391	.1024
TUI-01-12	3/4	.0016-.0024	0.8747	1.545	.1875	.0391	.1339
TUI-01-16	1	.0016-.0024	1.1247	2.205	.1875	.0391	.1496
TUI-01-20	1 1/4	.0020-.0032	1.4058	2.573	.1875	.0391	.1496
TUI-01-24	1 1/2	.0020-.0032	1.6558	2.953	.2500	.0625	.1811



TUI-01-XX
*2-piece design

Material: iglide® T500
Temp. range: -148°F to +482°F
Best Shaft Material: Hardened stainless and hard chrome plated steel

* according to igus® testing method ▶ Page 29.57

Housing Bore for Liner JUI-01/JUI-20/TUI-01

Dimensions (inch)

Part No.	Nominal Size	di		B *h10	r +0.002	t +0.004	f +0.02	z +0.008
		Max.	Min.					
JUI-01-06	3/8	.4680	.4684	.875	.1250	.031	.039	.102
JUI-01-08	1/2	.5940	.5934	1.250	.1250	.0391	.059	.122
JUI-01-10	5/8	.7190	.7184	1.500	.1406	.0391	.067	.142
JUI-01-12	3/4	.8755	.8747	1.625	.1875	.0391	.079	.142
JUI-01-16	1	1.1255	1.1247	2.250	.1875	.0391	.079	.161
JUI-01-20	1 1/4	1.4068	1.4058	2.625	.1875	.0391	.079	.161
JUI-01-24	1 1/2	1.6568	1.6558	3.000	.2500	.051	.098	.200
JUI-01-32	2	2.1881	2.1871	4.000	.2813	.051	.098	.240

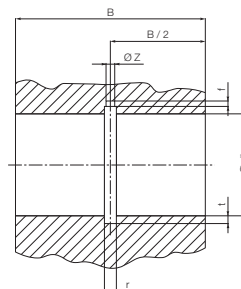

JUI-01/JUI-20/TUI-01 Liners are used in:

- ▶ RJUI-01 Page 29.12
- ▶ RJUI-03 Page 29.13
- ▶ TJUI-01 Page 29.14
- ▶ TJUI-03 Page 29.15



Online Lifetime Calculation
www.igus.com

PDF: www.igus.com/iglide-pdfs
 CAD: www.igus.com/iglide-CAD
 RoHS info: www.igus.com/RoHS

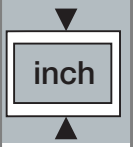



DryLin® R - Open Liner, inch JU10-0, Standard JU10-20, Low Clearance

DryLin® R
Linear Guide Systems

Telephone 1-800-521-2747
1-401-438-7270
Fax

Internet: <http://www.igus.com>
email: sales@igus.com
QuickSpec: <http://www.igus.com/iglide-quickspec>

Special Properties

- Open design for supported shafts
- Very low coefficient of friction while running dry
- Very high wear resistance
- Maintenance-free
- Vibration dampening
- Very low moisture absorption
- High chemical resistance
- Suitable for rotating, oscillating and linear movements
- High temperature T500 liners available for up to 482°F

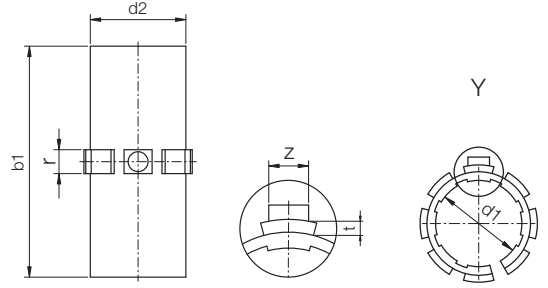

Part No.	Nominal Size	Tolerance	d2	b1	W	r	t	z
						-0.004	-0.004	-0.020
						-0.008		

Standard Clearance

JU10-01-06	3/8	.0016-.0024	0.4684	0.846	0.250	.1250	.0311	.0866
JU10-01-08	1/2	.0016-.0024	0.5934	1.220	0.394	.1250	.0391	.1024
JU10-01-10	5/8	.0016-.0024	0.7184	1.460	0.433	.1406	.0391	.1181
JU10-01-12	3/4	.0016-.0024	0.8747	1.575	0.492	.1875	.0391	.1339
JU10-01-16	1	.0016-.0024	1.1247	2.205	0.630	.1875	.0391	.1496
JU10-01-20	1 1/4	.0020-.0032	1.4058	2.573	0.709	.1875	.0391	.1496
JU10-01-24	1 1/2	.0020-.0032	1.6558	2.953	0.866	.2500	.0625	.1811
JU10-01-32	2	.0024-.0040	2.1871	4.937	1.181	.2813	.0625	.2280



Material: iglide® J
Temp. range: -40°F to +194°F
Best Shaft Material: DryLin® AWI hard anodized aluminum, case hardened steel, 300 series stainless

Low Clearance

JU10-20-06	3/8	.0008-.0012	0.4684	0.846	0.250	.1250	.0311	.0866
JU10-20-08	1/2	.0008-.0012	0.5934	1.220	0.394	.1250	.0391	.1024
JU10-20-10	5/8	.0008-.0012	0.7184	1.460	0.433	.1406	.0391	.1181
JU10-20-12	3/4	.0008-.0012	0.8747	1.575	0.492	.1875	.0391	.1339
JU10-20-16	1	.0008-.0012	1.1247	2.205	0.630	.1875	.0391	.1496
JU10-20-20	1 1/4	.0010-.0016	1.4058	2.573	0.709	.1875	.0391	.1496
JU10-20-24	1 1/2	.0010-.0016	1.6558	2.953	0.866	.2500	.0625	.1811
JU10-20-32	2	.0012-.0020	2.1871	4.937	1.181	.2813	.0625	.2280



Material: iglide® J
Temp. range: -40°F to +194°F
Best Shaft Material: DryLin® AWI hard anodized aluminum, case hardened steel, 300 series stainless

* according to igus® testing method ► Page 29.57

Installation Drawings

Housing Bore, Dimensions [Inch]

Part No.	Shaft Size Ø	di [inch]		B [inch] *h10	r [inch] +0.002	t [inch] +0.004	f [inch] +0.02	z [inch] +0.008	W [inch] +0.008
		Min.	Max.						
JU10-01/20-06	3/8	.4680	.4684	.875	.1250	.031	.039	.102	0.250
JU10-01/20-08	1/2	.5940	.5934	1.250	.1250	.031	.059	.122	0.394
JU10-01/20-10	5/8	.7190	.7184	1.500	.1406	.039	.067	.142	0.433
JU10-01/20-12	3/4	.8755	.8747	1.625	.1875	.039	.079	.142	0.492
JU10-01/20-16	1	1.1255	1.1247	2.250	.1875	.039	.079	.161	0.630
JU10-01/20-20	1 1/4	1.4068	1.4058	2.625	.1875	.039	.079	.161	0.709
JU10-01/20-24	1 1/2	1.6568	1.6558	3.000	.2500	.062	.089	.200	0.866
JU10-01/20-32	2	2.1881	2.1871	4.000	.2813	.062	.098	.240	1.181

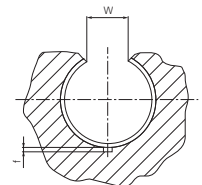
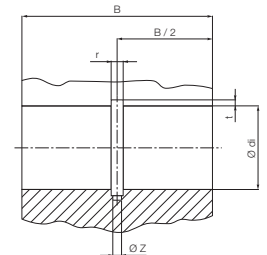

*See ISO tolerance information on Page 29.57

JU10-01 Liners are used in:
► OJUI-01, Page 29.16
► OJUI-03, Page 29.17



Special Properties

- Plain bearing made from iglide® J
- Dimensionally interchangeable with linear ball bearings
- Secured by retaining clips (not included in delivery)
- Designed as a press-fit part
- Temperature range: -40°F to +194°F
- Best with DryLin® AWI shafting, case-hardened steel, 300 series stainless and others (call for assistance)

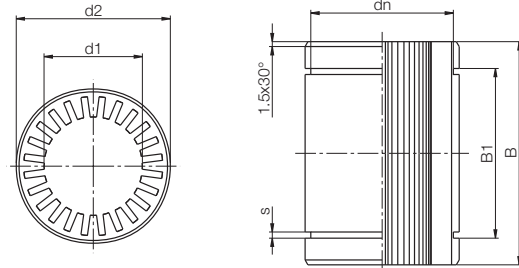

Dimensions (inch)

Part No.	d1	d2	B -.011	B1 .008	S .004	dn
RJI-01-06	3/8	.6250	.8750	.6890	.0410	.5870
RJI-01-08	1/2	.8750	1.2500	1.0120	.0520	.8200
RJI-01-10	5/8	1.1250	1.5000	1.0950	.0620	1.0600
RJI-01-12	3/4	1.2500	1.6200	1.2500	.0620	1.1770
RJI-01-16	1	1.5625	2.2500	1.8640	.0740	1.4710
RJI-01-20	1-1/4	2.0000	2.6250	1.9840	.0740	1.8890
RJI-01-24	1-1/2	2.3750	3.0000	2.3900	.0950	2.2410
RJI-01-32	2	3.0000	4.0000	3.1630	.1110	2.8390

Load Data

Part No.	Nominal Size	Tolerance for d1	pmax	pmax	Weight (oz.)
			Dynamic Load (lbs) p = 363 psi	Static Load (lbs) p = 2538 psi	
RJI-01-06	3/8	.0010 - .0024	67	417	.10
RJI-01-08	1/2	.0013 - .0030	80	555	.31
RJI-01-10	5/8	.0013 - .0030	141	992	.61
RJI-01-12	3/4	.0016 - .0036	204	1428	.78
RJI-01-16	1	.0016 - .0036	294	2062	1.5
RJI-01-20	1-1/4	.0020 - .0044	595	4163	2.86
RJI-01-24	1-1/2	.0020 - .0044	816	5710	4.48
RJI-01-32	2	.0024 - .0053	1452	10152	8.78

* according to igus® testing method ► Page 29.57

Housing Bore Recommendations

Nominal ID Size	Min.	Max.
3/8	0.6250	0.6257
1/2	0.8750	0.8758
5/8	1.1250	1.1258
3/4	1.2500	1.2510
1	1.5620	1.5630
1-1/4	2.0000	2.0010
1-1/2	2.3750	2.3760
2	3.0000	3.0010

RJI is a press-fit part. It will be oversized prior to installation



online lifetime calculation
www.igus.com

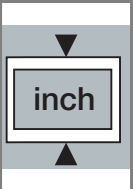



DryLin® R Straight Linear Plain Bearing - Inch

Special Properties

- Anodized aluminum adapter (Stainless available upon request)
- Dimensionally interchangeable with linear ball bearings
- Equipped with liner made of iglide® J
Temperature range -40°F to +194°F
JUI-01 (standard), JUI-20 (low clearance)
- T500 liner optional for chemicals/high temps (up to 482°F for steel housing, 356°F for aluminum)
- Suitable shafting for iglide® J: DryLin® AWI aluminum, case-hardened, 300 series stainless
Best shafting for T500: hard-chrome and hard-stainless steel

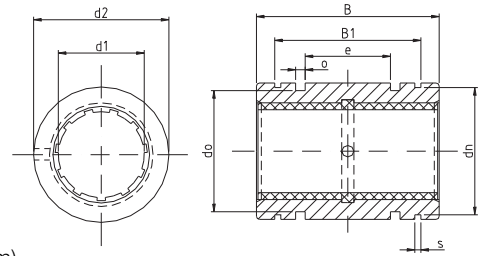

DryLin® R
Linear Guide Systems

Telephone 1-800-521-2747
1-401-438-7270
Fax

RJUI-01, Standard Clearance

Dimensions (inch)

Part No.	Nominal Size	Tolerance**	d2	B	B1	s	dn	e	o	do
			ISO h7	ISO h10	ISO H10					
RJZI-01-04*	1/4	.0016 - .0032	.5000	.7500	.518	.0410	.4670	.125	.0800	.3990
RJUI-01-06	3/8	.0016 - .0032	.6250	.8700	.644	.0410	.5870	.243	.0610	.5660
RJUI-01-08	1/2	.0016 - .0032	.8750	1.2500	.979	.0520	.8200	.281	.1250	.7120
RJUI-01-10	5/8	.0016 - .0032	1.1250	1.5000	1.124	.0620	1.0600	.312	.1250	.9620
RJUI-01-12	3/4	.0016 - .0032	1.2500	1.6200	1.186	.0620	1.1770	.312	.1250	1.0870
RJUI-01-16	1	.0016 - .0032	1.5625	2.2500	1.773	.0740	1.4710	.500	.1250	1.3990
RJUI-01-20	1-1/4	.0020 - .0041	2.0000	2.6200	2.023	.0740	1.8890	.625	.1250	1.8370
RJUI-01-24	1-1/2	.0020 - .0041	2.3750	3.0000	2.440	.0950	2.2410	.750	.1620	2.1520
RJUI-01-32	2	.0024 - .0051	3.0000	4.0000	3.222	.1110	2.8390	1.000	.1890	2.7750

RJUI-21, Low Clearance

Dimensions (inch)

Part No.	Nominal Size	Tolerance**	d2	B	B1	s	dn	e	o	do
			ISO h7	ISO h10	ISO H10					
RJUI-21-06	3/8	.0008 - .0016	.6250	.8700	.644	.0410	.5870	.243	.0610	.5660
RJUI-21-08	1/2	.0008 - .0016	.8750	1.2500	.979	.0520	.8200	.281	.1250	.7120
RJUI-21-10	5/8	.0008 - .0016	1.1250	1.5000	1.124	.0620	1.0600	.312	.1250	.9620
RJUI-21-12	3/4	.0008 - .0016	1.2500	1.6200	1.186	.0620	1.1770	.312	.1250	1.0870
RJUI-21-16	1	.0008 - .0016	1.5625	2.2500	1.773	.0740	1.4710	.500	.1250	1.3990
RJUI-21-20	1-1/4	.0010 - .0021	2.0000	2.6200	2.023	.0740	1.8890	.625	.1250	1.8370
RJUI-21-24	1-1/2	.0010 - .0021	2.3750	3.0000	2.440	.0950	2.2410	.750	.1620	2.1520
RJUI-21-32	2	.0012 - .0026	3.0000	4.0000	3.222	.1110	2.8390	1.000	.1890	2.7750

Housing Bore Recommendations

Nominal ID Size	Min. Max.	
	1/4	0.5000
3/8	0.6250	0.6257
1/2	0.8750	0.8758
5/8	1.1250	1.1258
3/4	1.2500	1.2510
1	1.5625	1.5635
1-1/4	2.0000	2.0010
1-1/2	2.3750	2.3760
2	3.0000	3.0010

Load Data

Part No.	pmax Dynamic Load (lbs) p = 725 psi	pmax Static Load (lbs) p = 5075 psi
	RJZI-01-04*	135
RJUI-01-06 / RJUI-21-06	118	828
RJUI-01-08 / RJUI-21-08	225	1575
RJUI-01-10 / RJUI-21-10	338	2365
RJUI-01-12 / RJUI-21-12	439	3077
RJUI-01-16 / RJUI-21-16	811	5678
RJUI-01-20 / RJUI-21-20	1184	8287
RJUI-01-24 / RJUI-21-24	1622	11358
RJUI-01-32 / RJUI-21-32	2885	20198

* Nominal widths under 3/8 inch are delivered with pressfit sleeve bearings

** according to igus® testing method ▶ Page 29.57

Internet: <http://www.igus.com>
email: sales@igus.com
QuickSpec: <http://www.igus.com/iglide-quickspec>

DryLin® R Self-Aligning Linear Plain Bearing, inch



Special Properties

- Hard anodized aluminum (Stainless available upon request)
- Compensates +/- 0.5° angle error
- Approximately 0.007" smaller OD for parallelism errors
- iglide® J Temperature range -40°F to +194°F
JUI-01 (standard), JUI-20 (low clearance)
- T500 liner optional for chemicals/high temps, 356°F for aluminum
- Suitable shafting for iglide® J: DryLin® AWI aluminum, case-hardened, 300 series stainless
Best shafting for T500: hard-chrome and hard-stainless steel
- Includes o-rings (o-ring grease recommended for install)
- Secure by retaining clips (not included)

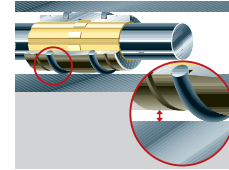
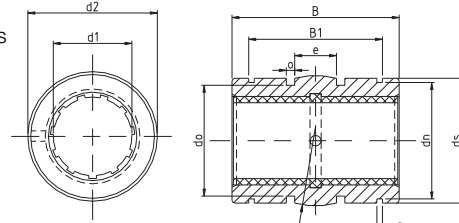

DryLin® R
Linear Guide Systems

RJUI-03, Standard Clearance

Dimensions (inch)

Part No.	Nominal Size	Tolerance**	d2 ISO h8	B ISO h10	B1 ISO H10	s	ds	dn ISO h10	do	o -0.004	e
RJZI-03-04*	1/4	.0016-.0032	.4921	.7460	.5270	.0410	.4803	.4660	.3990	.0800	.1250
RJUI-03-06	3/8	.0016-.0032	.6173	.8713	.6520	.0410	.6055	.5870	.5240	.0610	.2430
RJUI-03-08	1/2	.0016-.0032	.8673	1.2461	.9870	.0520	.8556	.8200	.7120	.1250	.2815
RJUI-03-10	5/8	.0016-.0032	1.1173	1.4961	1.1360	.0620	1.1055	1.0600	.9620	.1250	.3125
RJUI-03-12	3/4	.0016-.0032	1.2421	1.6173	1.1980	.0620	1.2300	1.1770	1.0870	.1250	.3125
RJUI-03-16	1	.0016-.0032	1.5547	2.2421	1.7890	.0740	1.5271	1.4710	1.3990	.1250	.5000
RJUI-03-20	1-1/4	.0020-.0041	1.9881	2.6173	2.0390	.0740	1.9606	1.8890	1.8370	.1250	.6250
RJUI-03-24	1-1/2	.0020-.0041	2.3634	2.9921	2.4630	.0950	2.3358	2.2410	2.1520	.1620	.7500
RJUI-03-32	2	.0024-.0051	2.9881	3.9921	3.2490	.1110	2.9606	2.8390	2.7750	.1890	1.0000

RJUI-23, Low Clearance

Dimensions (inch)

Part No.	Nominal Size	Tolerance**	d2 ISO h8	B ISO h10	B1 ISO H10	s	ds	dn ISO h10	do	o -0.004	e
RJUI-23-06	3/8	.0008-.0016	.6173	.8713	.6520	.0410	.6055	.5870	.5240	.0610	.2430
RJUI-23-08	1/2	.0008-.0016	.8673	1.2461	.9870	.0520	.8556	.8200	.7120	.1250	.2815
RJUI-23-10	5/8	.0008-.0016	1.1173	1.4961	1.1360	.0620	1.1055	1.0600	.9620	.1250	.3125
RJUI-23-12	3/4	.0008-.0016	1.2421	1.6173	1.1980	.0620	1.2300	1.1770	1.0870	.1250	.3125
RJUI-23-16	1	.0008-.0016	1.5547	2.2421	1.7890	.0740	1.5271	1.4710	1.3990	.1250	.5000
RJUI-23-20	1-1/4	.0010-.0021	1.9881	2.6173	2.0390	.0740	1.9606	1.8890	1.8370	.1250	.6250
RJUI-23-24	1-1/2	.0010-.0021	2.3634	2.9921	2.4630	.0950	2.3358	2.2410	2.1520	.1620	.7500
RJUI-23-32	2	.0012-.0026	2.9881	3.9921	3.2490	.1110	2.9606	2.8390	2.7750	.1890	1.0000

PDF: www.igus.com/iglide-pdfs
CAD: www.igus.com/iglide-CAD
RoHS info: www.igus.com/RoHS

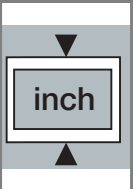

Housing Bore Recommendations

Nominal ID Size	Min.	Max.
1/4	0.5000	0.5007
3/8	0.6250	0.6257
1/2	0.8750	0.8758
5/8	1.1250	1.1258
3/4	1.2500	1.2510
1	1.5625	1.5635
1-1/4	2.0000	2.0010
1-1/2	2.3750	2.3760
2	3.0000	3.0010

Load Data

Part No.	pmax Dynamic Load (lbs) p = 725 psi	pmax Static Load (lbs) p = 5075 psi
RJZI-03-04*	135	946
RJUI-03-06 / RJUI-23-06	118	828
RJUI-03-08 / RJUI-23-08	225	1575
RJUI-03-10 / RJUI-23-10	338	2365
RJUI-03-12 / RJUI-23-12	439	3077
RJUI-03-16 / RJUI-23-16	811	5678
RJUI-03-20 / RJUI-23-20	1184	8287
RJUI-03-24 / RJUI-23-24	1622	11358
RJUI-03-32 / RJUI-23-32	2885	20198

* Nominal widths under 3/8 inch are delivered with pressfit sleeve bearings

** according to igus® testing method ▶ Page 29.57



DryLin® R Straight, Split Linear Bearings, inch

DryLin® R
Linear Guide Systems



Special Properties

- Anodized aluminum adapter
- Dimensionally interchangeable with linear ball bearings
- Equipped with liner made of iglide® J
Temperature range -40°F to +194°F
JUI-01 (standard), JUI-20 (low clearance)
- T500 liner optional for chemicals/high temps
(up to 482°F for steel housing, 356°F for aluminum)
- Suitable shafting for iglide® J: DryLin® AWI aluminum, case-hardened, 300 series stainless
Best shafting for T500: hard-chrome and hard-stainless steel

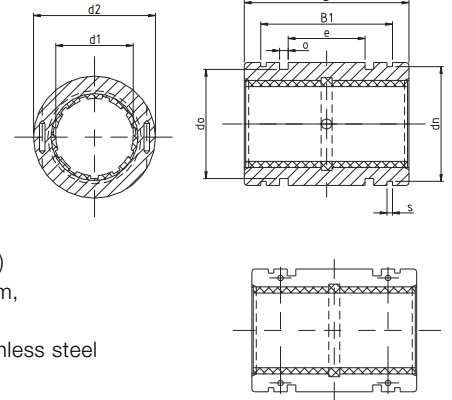

TJUI-01, Standard Clearance

Dimensions (inch)

Part No.	Nominal Size	Tolerance*	d2 ISO f7	B ISO h10	B1 ISO H10	s	dn	e	o +0.008	do
TJUI-01-08	1/2	.0016 - .0036	.8750	1.2500	.979	.0520	.8200	.281	.1250	.7120
TJUI-01-10	5/8	.0016 - .0036	1.1250	1.5000	1.124	.0620	1.0600	.312	.1250	.9620
TJUI-01-12	3/4	.0016 - .0036	1.2500	1.6250	1.186	.0620	1.1770	.312	.1250	1.0870
TJUI-01-16	1	.0016 - .0036	1.5625	2.2500	1.773	.0740	1.4710	.500	.1250	1.3990
TJUI-01-20	1-1/4	.0020 - .0039	2.0000	2.6250	2.023	.0740	1.8890	.625	.1250	1.8370
TJUI-01-24	1-1/2	.0020 - .0047	2.3750	3.0000	2.440	.0950	2.2410	.650	.1620	2.1520
TJUI-01-32	2	.0024 - .0057	3.0000	4.0000	3.222	.1110	2.8390	1.000	.1890	2.7750

TJUI-21, Low Clearance

Dimensions (inch)

Part No.	Nominal Size	Tolerance*	d2 ISO f7	B ISO h10	B1 ISO H10	s	dn	e	o +0.008	do
TJUI-21-08	1/2	.0008 - .0018	.8750	1.2500	.979	.0520	.8200	.281	.1250	.7120
TJUI-21-10	5/8	.0008 - .0018	1.1250	1.5000	1.124	.0620	1.0600	.312	.1250	.9620
TJUI-21-12	3/4	.0008 - .0018	1.2500	1.6250	1.186	.0620	1.1770	.312	.1250	1.0870
TJUI-21-16	1	.0008 - .0018	1.5625	2.2500	1.773	.0740	1.4710	.500	.1250	1.3990
TJUI-21-20	1-1/4	.0010 - .0020	2.0000	2.6250	2.023	.0740	1.8890	.625	.1250	1.8370
TJUI-21-24	1-1/2	.0010 - .0024	2.3750	3.0000	2.440	.0950	2.2410	.650	.1620	2.1520
TJUI-21-32	2	.0012 - .0029	3.0000	4.0000	3.222	.1110	2.8390	1.000	.1890	2.7750

Housing Bore Recommendations

Nominal ID Size	Min.	Max.
1/4	0.5000	0.5007
3/8	0.6250	0.6257
1/2	0.8750	0.8758
5/8	1.1250	1.1258
3/4	1.2500	1.2510
1	1.5625	1.5635
1-1/4	2.0000	2.0010
1-1/2	2.3750	2.3760
2	3.0000	3.0010

Load Data

Part No.	pmax Dynamic Load (lbs) p = 725 psi	pmax Static Load (lbs) p = 5075 psi
	TJUI-01-08 / TJUI-03-08	225
TJUI-01-10 / TJUI-03-10	338	2365
TJUI-01-12 / TJUI-03-12	439	3077
TJUI-01-16 / TJUI-03-16	811	5678
TJUI-01-20 / TJUI-03-20	1184	8287
TJUI-01-24 / TJUI-03-24	1622	11358
TJUI-01-32 / TJUI-03-32	2885	20198

Material: iglide® J

Temp. range: -40°F to +194°F

Best Shaft Material: DryLin® AWI hard anodized aluminum, case hardened steel, 300 series stainless

* according to igus® testing method ▶ Page 29.57

Telephone 1-800-521-2747
1-401-438-7270
Fax

Internet: <http://www.igus.com>
email: sales@igus.com
QuickSpec: <http://www.igus.com/iglide-quickspec>

DryLin® R Self-Aligning, Split Linear Plain Bearing, inch



Special Properties

- Anodized aluminum adapter
- Dimensionally interchangeable with linear ball bearings
- iglide® J Temperature range -40°F to +194°F
- T500 liner optional for chemicals/high temps (up to 482°F for steel housing, 356°F for aluminum)
- Suitable shafting for iglide® J: DryLin® AWI aluminum, case-hardened, 300 series stainless
Best shafting for T500: hard-chrome and hard-stainless steel
- Includes o-rings (o-ring grease recommended for install)

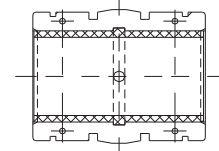
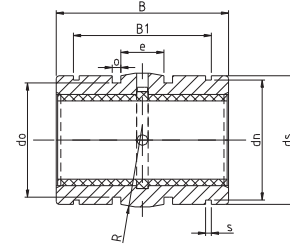
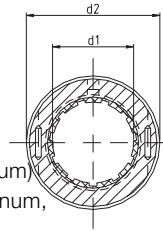

TJUI-03, Standard Clearance

Dimensions (inch)

Part No.	∅ Shaft	Tolerance*	d2 ISO f7	B ISO h10	B1 ISO H10	s	ds	do	o +0.008	e
TJUI-03-08	1/2	.0016 - .0036	.8750	1.2420	.987	.0520	.8563	.7120	.1250	.2815
TJUI-03-10	5/8	.0016 - .0036	1.1250	1.4920	1.136	.0620	1.1039	.9620	.1250	.3125
TJUI-03-12	3/4	.0016 - .0036	1.2500	1.6170	1.198	.0620	1.2276	1.0870	.1250	.3125
TJUI-03-16	1	.0016 - .0036	1.5625	2.2382	1.789	.0740	1.5350	1.3990	.1250	.5000
TJUI-03-20	1-1/4	.0020 - .0039	2.0000	2.6134	2.039	.0740	1.9654	1.8370	.1250	.6250
TJUI-03-24	1-1/2	.0020 - .0047	2.3750	2.9843	2.463	.0950	2.3370	2.1520	.1620	.7500
TJUI-03-32	2	.0024 - .0057	3.0000	3.9803	3.249	.1110	2.9531	2.7750	.1890	1.0000

TJUI-23, Low Clearance

Dimensions (inch)

Part No.	∅ Shaft	Tolerance*	d2 ISO f7	B ISO h10	B1 ISO H10	s	ds	do	o +0.008	e
TJUI-23-08	1/2	.0008 - .0018	.8750	1.2420	.987	.0520	.8563	.7120	.1250	.2815
TJUI-23-10	5/8	.0008 - .0018	1.1250	1.4920	1.136	.0620	1.1039	.9620	.1250	.3125
TJUI-23-12	3/4	.0008 - .0018	1.2500	1.6170	1.198	.0620	1.2276	1.0870	.1250	.3125
TJUI-23-16	1	.0008 - .0018	1.5625	2.2382	1.789	.0740	1.5350	1.3990	.1250	.5000
TJUI-23-20	1-1/4	.0010 - .0020	2.0000	2.6134	2.039	.0740	1.9654	1.8370	.1250	.6250
TJUI-23-24	1-1/2	.0010 - .0024	2.3750	2.9843	2.463	.0950	2.3370	2.1520	.1620	.7500
TJUI-23-32	2	.0012 - .0029	3.0000	3.9803	3.249	.1110	2.9531	2.7750	.1890	1.0000

* according to iglus® testing method ▶ Page 29.57

Housing Bore Recommendations

Nominal ID Size	Min.	Max.
1/4	0.5000	0.5007
3/8	0.6250	0.6257
1/2	0.8750	0.8758
5/8	1.1250	1.1258
3/4	1.2500	1.2510
1	1.5625	1.5635
1-1/4	2.0000	2.0010
1-1/2	2.3750	2.3760
2	3.0000	3.0010

Benefits

- Drastically reduce machine downtime
- Replace bearings without removing shafts
- Unique, cost-effective solution versus ball bearings

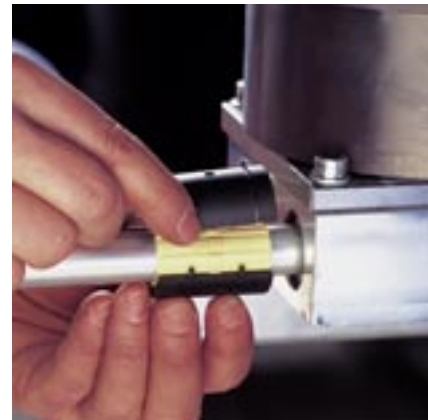

DryLin® R
Linear Guide Systems

PDF: www.igus.com/iglide-pdfs
CAD: www.igus.com/iglide-CAD
RoHS info: www.igus.com/RoHS

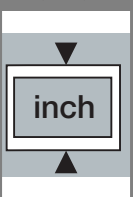



iglus®

DryLin® R Straight, Open Linear Bearing, inch

Special Properties

- Anodized aluminum adapter
- Dimensionally interchangeable with linear ball bearings
- Equipped with liner made of iglide® J
Temperature range -40°F to +194°F
JUJO-01 (standard), JUI-20 (low clearance)
- T500 liner optional for chemicals/high temps
(up to 482°F for steel housing, 356°F for aluminum)
- Suitable shafting for iglide® J: DryLin® AW1 aluminum, case-hardened, 300 series stainless
Best shafting for T500: hard-chrome and hard-stainless steel

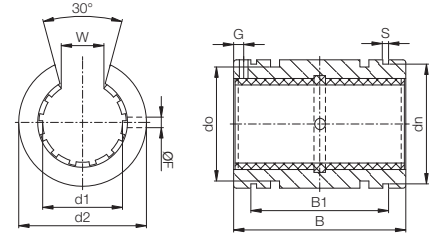

OJUI-01, Standard Clearance

Dimensions (inch)

Part No..	Ø Shaft	Tolerance*	d2 ISO h7	B ISO h10	W ±0.012	s	dn ISO h10	B1 ISO H10	F +0.004	G +0.004	do
OJUI-01-08	1/2	.0016 - .0032	.8750	1.2500	.3940	.0520	.8200	.979	.1360	.6250	.684
OJUI-01-10	5/8	.0016 - .0032	1.1250	1.5000	.4330	.0620	1.0600	1.124	.1360	.1250	.934
OJUI-01-12	3/4	.0016 - .0032	1.2500	1.6250	.4920	.0620	1.1770	1.186	.1360	.1250	1.059
OJUI-01-16	1	.0016 - .0032	1.5625	2.2500	.6300	.0740	1.4710	1.773	.1360	.1250	1.372
OJUI-01-20	1-1/4	.0020 - .0041	2.0000	2.6250	.7090	.0740	1.8890	2.023	.2010	.1875	1.809
OJUI-01-24	1-1/2	.0020 - .0041	2.3750	3.0000	.8660	.0950	2.2410	2.440	.2010	.1875	2.113
OJUI-01-32	2	.0024 - .0051	3.0000	4.0000	1.1810	.1110	2.8390	3.222	.2650	.3125	2.738

OJUI-21, Low Clearance

Dimensions (inch)

Part No..	Ø Shaft	Tolerance*	d2 ISO h7	B ISO h10	W ±0.012	s	dn ISO h10	B1 ISO H10	F +0.004	G +0.004	do
OJUI-21-08	1/2	.0008 - .0016	.8750	1.2500	.3940	.0520	.8200	.979	.1360	.6250	.684
OJUI-21-10	5/8	.0008 - .0016	1.1250	1.5000	.4330	.0620	1.0600	1.124	.1360	.1250	.934
OJUI-21-12	3/4	.0008 - .0016	1.2500	1.6250	.4920	.0620	1.1770	1.186	.1360	.1250	1.059
OJUI-21-16	1	.0008 - .0016	1.5625	2.2500	.6300	.0740	1.4710	1.773	.1360	.1250	1.372
OJUI-21-20	1-1/4	.0010 - .0021	2.0000	2.6250	.7090	.0740	1.8890	2.023	.2010	.1875	1.809
OJUI-21-24	1-1/2	.0010 - .0021	2.3750	3.0000	.8660	.0950	2.2410	2.440	.2010	.1875	2.113
OJUI-21-32	2	.0012 - .0026	3.0000	4.0000	1.1810	.1110	2.8390	3.222	.2650	.3125	2.738

* according to igus® testing method ▶ Page 29.57

Housing Bore Recommendations

Nominal ID Size	Min.	Max.
1/4	0.5000	0.5007
3/8	0.6250	0.6257
1/2	0.8750	0.8758
5/8	1.1250	1.1258
3/4	1.2500	1.2510
1	1.5625	1.5635
1-1/4	2.0000	2.0010
1-1/2	2.3750	2.3760
2	3.0000	3.0010

Load Data

Part No.	pmax. Dynamic Load P = 725 psi			pmax. Static Load P = 5075 psi		
	0°	90°	180°	0°	90°	180°
	OJUI-01-08 / OJUI-21-08	226	154	80	1585	1078
OJUI-01-10 / OJUI-21-10	340	231	118	2378	1617	832
OJUI-01-12 / OJUI-21-12	408	277	143	2854	1942	998
OJUI-01-16 / OJUI-21-16	590	400	206	4123	2804	1443
OJUI-01-20 / OJUI-21-20	1189	809	416	8323	5659	2912
OJUI-01-24 / OJUI-21-24	1631	1109	571	11418	7765	3996
OJUI-01-32 / OJUI-21-32	2900	1972	1015	20300	13804	7104

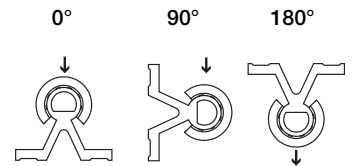

Internet: <http://www.igus.com>
 email: sales@igus.com
 QuickSpec: <http://www.igus.com/iglide-quickspec>

DryLin® R
Linear Guide Systems

Telephone 1-800-521-2747
1-401-438-7270
Fax

DryLin® R Self-Aligning, Open Linear Plain Bearing, inch



Special Properties

- Hard anodized aluminum adapter
- Dimensionally interchangeable with linear ball bearings
- Equipped with liner made of iglide® J
Temperature range -40°F to +194°F
JUJO-01 (standard), JUJO-20 (low clearance)
- T500 liner optional for chemicals/high temps
(up to 482°F for steel housing, 356°F for aluminum)
- Suitable shafting for iglide® J: DryLin® AWI aluminum, case-hardened, 300 series stainless
Best shafting for T500: hard-chrome and hard-stainless steel

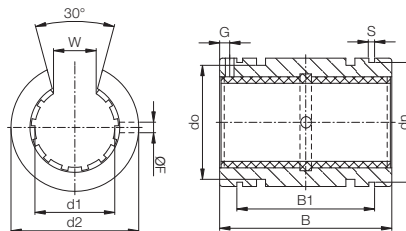

OJUI-03, Standard Clearance

Dimensions (inch)

Part No.	Ø Shaft	Tolerance*	d2 ISO h8	ds ISO h10	F +0.004	G +0.004	do	B1 ISO H10	s ISO H10	dn ISO h10	B ISO h10	W +0.012
OJUI-03-08	1/2	.0016 - .0032	.8673	.8556	.1360	.6250	.6846	.987	.0520	.8200	1.2461	.3940
OJUI-03-10	5/8	.0016 - .0032	1.1173	1.1055	.1360	.1250	.9346	1.136	.0620	1.0600	1.4961	.4330
OJUI-03-12	3/4	.0016 - .0032	1.2421	1.2300	.1360	.1250	1.0590	1.198	.0620	1.1770	1.6173	.4920
OJUI-03-16	1	.0016 - .0032	1.5547	1.5271	.1360	.1250	1.3720	1.789	.0740	1.4710	2.2421	.6300
OJUI-03-20	1-1/4	.0020 - .0041	1.9881	1.9606	.2010	.1875	1.8094	2.039	.0740	1.8890	2.6173	.7090
OJUI-03-24	1-1/2	.0020 - .0041	2.3634	2.3358	.2010	.1875	2.1130	2.463	.0950	2.2410	2.9921	.8660
OJUI-03-32	2	.0024 - .0051	2.988	2.9606	.2650	.3125	2.7378	3.249	.1110	2.8390	3.9921	1.1810

OJUI-23, Low Clearance

Dimensions (inch)

Part No.	Ø Shaft	Tolerance*	d2 ISO h8	ds ISO h10	F +0.004	G +0.004	do	B1 ISO H10	s ISO H10	dn ISO h10	B ISO h10	W +0.012
OJUI-23-08	1/2	.0008 - .0016	.8673	.8556	.1360	.6250	.6846	.987	.0520	.8200	1.2461	.3940
OJUI-23-10	5/8	.0008 - .0016	1.1173	1.1055	.1360	.1250	.9346	1.136	.0620	1.0600	1.4961	.4330
OJUI-23-12	3/4	.0008 - .0016	1.2421	1.2300	.1360	.1250	1.0590	1.198	.0620	1.1770	1.6173	.4920
OJUI-23-16	1	.0008 - .0016	1.5547	1.5271	.1360	.1250	1.3720	1.789	.0740	1.4710	2.2421	.6300
OJUI-23-20	1-1/4	.0010 - .0021	1.9881	1.9606	.2010	.1875	1.8094	2.039	.0740	1.8890	2.6173	.7090
OJUI-23-24	1-1/2	.0010 - .0021	2.3634	2.3358	.2010	.1875	2.1130	2.463	.0950	2.2410	2.9921	.8660
OJUI-23-32	2	.0012 - .0026	2.988	2.9606	.2650	.3125	2.7378	3.249	.1110	2.8390	3.9921	1.1810

* according to igus® testing method ▶ Page 29.57

Housing Bore Recommendations

Nominal ID Size	Min.	Max.
1/4	0.5000	0.5007
3/8	0.6250	0.6257
1/2	0.8750	0.8758
5/8	1.1250	1.1258
3/4	1.2500	1.2510
1	1.5625	1.5635
1-1/4	2.0000	2.0010
1-1/2	2.3750	2.3760
2	3.0000	3.0010

Load Data

Part No.	pmax. Dynamic Load P = 725 psi			pmax. Static Load P = 5075 psi		
	0°	90°	180°	0°	90°	180°
	OJUI-03-08 / OJUI-23-08	226	154	80	1585	1078
OJUI-03-10 / OJUI-23-10	340	231	118	2378	1617	832
OJUI-03-12 / OJUI-23-12	408	277	143	2854	1942	998
OJUI-03-16 / OJUI-23-16	590	400	206	4123	2804	1443
OJUI-03-20 / OJUI-23-20	1189	809	416	8323	5659	2912
OJUI-03-24 / OJUI-23-24	1631	1109	571	11418	7765	3996
OJUI-03-32 / OJUI-23-32	2900	1972	1015	20300	13804	7104

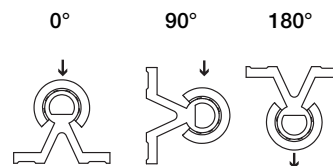

PDF: www.igus.com/iglide-pdfs
CAD: www.igus.com/iglide-CAD
RoHS info: www.igus.com/RoHS





DryLin® R Straight Bearing, Closed Pillow Block, inch

DryLin® R
Linear Guide Systems

Telephone 1-800-521-2747
Fax 1-401-438-7270

Internet: <http://www.igus.com>
email: sales@igus.com
QuickSpec: <http://www.igus.com/iglide-quickspec>

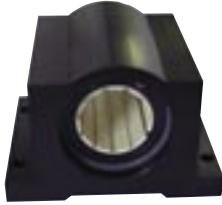

Special Properties

- Closed, anodized aluminum housing
- Liner JUI-01 made of iglide® J is contained according to standard tolerances
- Can be fitted with iglide® T500 liner material for temperatures up to 356°F
- Low clearance liners optional
- Dimensionally interchangeable with ball bearings

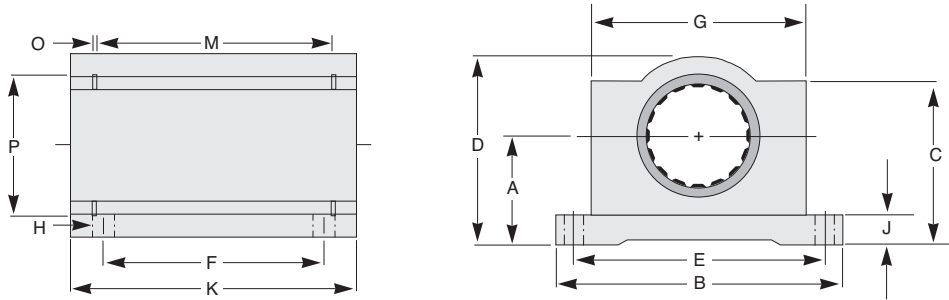

RJUI-XX, Bearing

Dimensions (inch)

Part No.	Nom. Size	A ±.001	B	C	D ±.010	E ±.010	F	G	H		J	K	M	O	P
									BOLT	HOLE					
RJZI- <input type="text"/> -04	1/4	0.437	1.625	0.750	0.813	1.312	0.750	1.000	#6	5/32	0.188	1.188	0.750	0.039	0.532
RJUI- <input type="text"/> -06	3/8	0.500	1.750	0.875	0.938	1.437	0.875	1.125	#6	5/32	0.188	1.313	0.875	0.039	0.665
RJUI- <input type="text"/> -08	1/2	0.687	2.000	1.125	1.250	1.688	1.000	1.375	#6	5/32	0.250	1.688	1.250	0.046	0.931
RJUI- <input type="text"/> -10	5/8	0.875	2.500	1.438	1.625	2.125	1.125	1.750	#8	3/16	0.281	1.938	1.500	0.056	1.197
RJUI- <input type="text"/> -12	3/4	0.937	2.750	1.563	1.750	2.375	1.250	1.875	#8	3/16	0.313	2.063	1.625	0.056	1.330
RJUI- <input type="text"/> -16	1	1.187	3.250	1.938	2.188	2.875	1.750	2.375	#10	7/32	0.375	2.813	2.250	0.068	1.671
RJUI- <input type="text"/> -20	1-1/4	1.500	4.000	2.500	2.813	3.500	2.000	3.000	#10	7/32	0.438	3.625	2.625	0.068	2.122
RJUI- <input type="text"/> -24	1-1/2	1.750	4.750	2.875	3.250	4.125	2.500	3.500	1/4	9/32	0.500	4.000	3.000	0.086	2.519
RJUI- <input type="text"/> -32	2	2.125	6.000	3.625	4.063	5.250	3.250	4.500	3/8	13/32	0.625	5.000	4.000	0.103	3.182

Supplement the part number with one of the following choices.
Example: RJUI--04 for a self aligning version

For Straight bearing use (see page 29.12)

For Self-Aligning bearing use (see page 29.13)

For Low Clearance Straight use (see page 29.12)

For Low Clearance Self-Aligning use (see page 29.13)



Online lifetime calculation
www.igus.com

Load Data

Part No.	Dynamic Load (lbs)		Static Load (lbs)	
	P = 725 psi		P = 5075 psi	
RJZI- <input type="text"/> -04	135		946	
RJUI- <input type="text"/> -06	118		828	
RJUI- <input type="text"/> -08	225		1575	
RJUI- <input type="text"/> -10	338		2365	
RJUI- <input type="text"/> -12	439		3077	
RJUI- <input type="text"/> -16	811		5678	
RJUI- <input type="text"/> -20	1184		8287	
RJUI- <input type="text"/> -24	1622		11358	
RJUI- <input type="text"/> -32	2885		20198	

DryLin® R Straight Bearing, Open Pillow Block, inch



Special Properties

- Open, anodized aluminum housing
- Liner JUI-01 made of iglide® J is contained according to standard tolerances
- Can be fitted with iglide® T500 liner material for temperatures up to 356°F
- Low clearance liners optional
- Dimensionally interchangeable with ball bearings

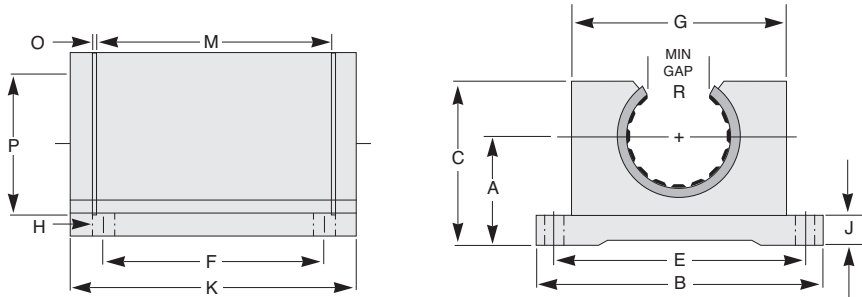

OJUI-XX, Bearing

Dimensions (inch)

Part No.	Nom. Size	A ±.001	B	C	E ±.010	F ±.010	G	H		J	K	M	O	P	R
								BOLT	HOLE						
OJUI-□-08	1/2	0.687	2.000	1.125	1.688	1.000	1.375	#6	5/32	0.250	1.688	1.250	0.046	0.931	0.313
OJUI-□-10	5/8	0.875	2.500	1.438	2.125	1.125	1.750	#8	3/16	0.281	1.938	1.500	0.056	1.197	0.375
OJUI-□-12	3/4	0.937	2.750	1.563	2.375	1.250	1.875	#8	3/16	0.313	2.063	1.625	0.056	1.330	0.438
OJUI-□-16	1	1.187	3.250	1.938	2.875	1.750	2.375	#10	7/32	0.375	2.813	2.250	0.068	1.671	0.563
OJUI-□-20	1-1/4	1.500	4.000	2.500	3.500	2.000	3.000	#10	7/32	0.438	3.625	2.625	0.068	2.122	0.625
OJUI-□-24	1-1/2	1.750	4.750	2.875	4.125	2.500	3.500	1/4	9/32	0.500	4.000	3.000	0.086	2.519	0.750
OJUI-□-32	2	2.125	6.000	3.625	5.250	3.250	4.500	3/8	13/32	0.625	5.000	4.000	0.103	3.182	1.000

Supplement the part number with one of the following choices.
Example: OJUI-**13**-04 for a self aligning version

For Straight bearing use **11** (see page 29.16)

For Self-Aligning bearing use **13** (see page 29.17)

For Low Clearance Straight use **31** (see page 29.16)

For Low Clearance Self-Aligning use **33** (see page 29.17)



Online lifetime calculation
www.igus.com

Load Data

Part No.	pmax. Dynamic Load			pmax. Static Load		
	P = 725 psi			P = 5075 psi		
	0°	90°	180°	0°	90°	180°
OJUI- XX -08	226	154	80	1585	1078	555
OJUI- XX -10	340	231	118	2378	1617	832
OJUI- XX -12	408	277	143	2854	1942	998
OJUI- XX -16	590	400	206	4123	2804	1443
OJUI- XX -20	1189	809	416	8323	5659	2912
OJUI- XX -24	1631	1109	571	11418	7765	3996
OJUI- XX -32	2900	1972	1015	20300	13804	7104

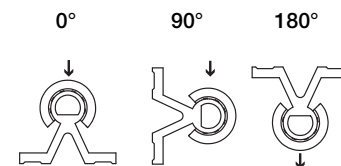

DryLin® R
Linear Guide Systems

PDF: www.igus.com/iglide-pdfs
CAD: www.igus.com/iglide-CAD
RoHS info: www.igus.com/RoHS

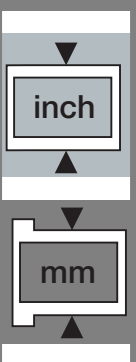



DryLin® R Straight Bearing, Closed Twin Pillow Block, inch,

DryLin® R
Linear Guide Systems

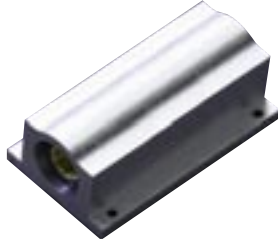

Special Properties

- Closed, anodized aluminum housing, twin design
- Liner JUI-01 made of iglide® J is contained according to standard tolerances
- Can be fitted with iglide® T500 liner material for temperatures up to 356°F
- Low clearance liners optional
- Dimensionally interchangeable with ball bearings

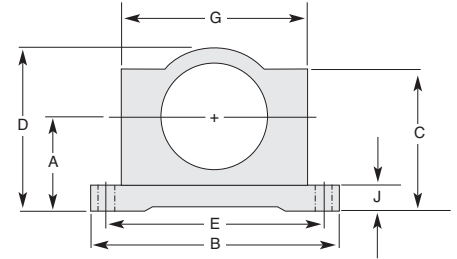
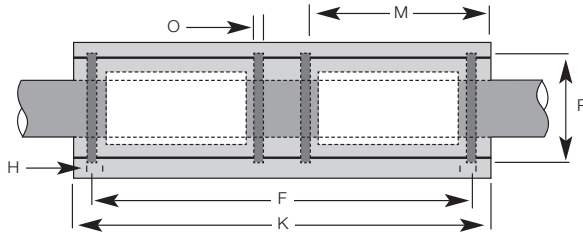

RJUI-XX-XXTW, Twin Pillow Block

Dimensions (inch)

Part No.	Nom. Size	A ±.001	B	C	D ±.010	E ±.010	F	G	H BOLT HOLE	J	K	M	O	P
RJZI- <input type="text"/> -04TW	1/4	0.437	1.625	0.750	0.813	1.312	2.000	1.000	#6 5/32	0.188	2.500	0.750	0.039	0.532
RJUI- <input type="text"/> -06TW	3/8	0.500	1.750	0.875	0.938	1.437	2.250	1.125	#6 5/32	0.188	2.750	0.875	0.039	0.665
RJUI- <input type="text"/> -08TW	1/2	0.687	2.000	1.125	1.250	1.688	2.500	1.375	#6 5/32	0.250	3.500	1.250	0.046	0.931
RJUI- <input type="text"/> -10TW	5/8	0.875	2.500	1.438	1.625	2.125	3.000	1.750	#8 3/16	0.281	4.000	1.500	0.056	1.197
RJUI- <input type="text"/> -12TW	3/4	0.937	2.750	1.563	1.750	2.375	3.500	1.875	#8 3/16	0.313	4.500	1.625	0.056	1.330
RJUI- <input type="text"/> -16TW	1	1.187	3.250	1.938	2.188	2.875	4.500	2.375	#10 7/32	0.375	6.000	2.250	0.068	1.671
RJUI- <input type="text"/> -20TW	1-1/4	1.500	4.000	2.500	2.813	3.500	5.500	3.000	#10 7/32	0.438	7.500	2.625	0.068	2.122
RJUI- <input type="text"/> -24TW	1-1/2	1.750	4.750	2.875	3.250	4.125	6.500	3.500	1/4 9/32	0.500	9.000	3.000	0.086	2.519
RJUI- <input type="text"/> -32TW	2	2.125	6.000	3.625	4.063	5.250	8.250	4.500	3/8 13/32	0.625	10.000	4.000	0.103	3.182

Supplement the part number with one of the following choices.
Example: RJUI--04TW for a self aligning version

For Straight bearing use 11 (see page 29.12)

For Self-Aligning bearing use 13 (see page 29.13)

For Low Clearance Straight use 31 (see page 29.12)

For Low Clearance Self-Aligning use 33 (see page 29.13)



Online lifetime calculation
www.igus.com

Load Data

Part No.	Dynamic Load (lbs)	Static Load (lbs)
	P = 725 psi	P = 5075 psi
RJZI- <input type="text"/> -04TW	135	946
RJUI- <input type="text"/> -06TW	118	828
RJUI- <input type="text"/> -08TW	225	1575
RJUI- <input type="text"/> -10TW	338	2365
RJUI- <input type="text"/> -12TW	439	3077
RJUI- <input type="text"/> -16TW	811	5678
RJUI- <input type="text"/> -20TW	1184	8287
RJUI- <input type="text"/> -24TW	1622	11358
RJUI- <input type="text"/> -32TW	2885	20198

Telephone 1-800-521-2747
1-401-438-7270
Fax

Internet: <http://www.igus.com>
email: sales@igus.com
QuickSpec: <http://www.igus.com/iglide-quickspec>

DryLin® R Straight Bearing, Open Twin Pillow Block, inch



Special Properties

- Open, anodized aluminum housing, twin design
- Liner JU10-01 made of iglide® J is contained according to standard tolerances
- Can be fitted with iglide® T500 liner material for temperatures up to 356°F
- Low clearance liners optional
- Dimensionally interchangeable with ball bearings

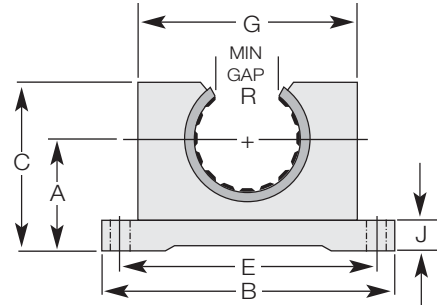
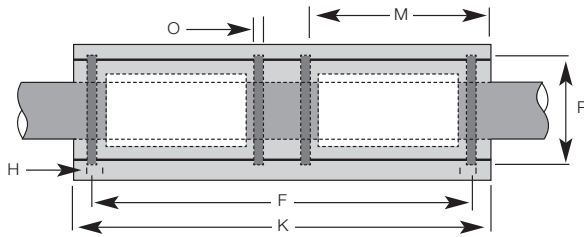

OJUI-XX-XXTW, Straight Bearing

Dimensions (inch)

Part No.	Nom. Size	A ±.001	B	C	E ±.010	F ±.010	G	H BOLT HOLE	J	K	M	O	P	R
OJUI-□-08TW	1/2	0.687	2.000	1.125	1.688	2.500	1.375	#6 5/32	0.250	3.500	1.250	0.046	0.931	0.313
OJUI-□-10TW	5/8	0.875	2.500	1.438	2.125	3.000	1.750	#8 3/16	0.281	4.000	1.500	0.056	1.197	0.375
OJUI-□-12TW	3/4	0.937	2.750	1.563	2.375	3.500	1.875	#8 3/16	0.313	4.500	1.625	0.056	1.330	0.438
OJUI-□-16TW	1	1.187	3.250	1.938	2.875	4.500	2.375	#10 7/32	0.375	6.000	2.250	0.068	1.671	0.563
OJUI-□-20TW	1-1/4	1.500	4.000	2.500	3.500	5.500	3.000	#10 7/32	0.438	7.500	2.625	0.068	2.122	0.625
OJUI-□-24TW	1-1/2	1.750	4.750	2.875	4.125	6.500	3.500	1/4 9/32	0.500	9.000	3.000	0.086	2.519	0.750
OJUI-□-32TW	2	2.125	6.000	3.625	5.250	8.250	4.500	3/8 13/32	0.625	10.000	4.000	0.103	3.182	1.000

Supplement the part number with one of the following choices.
Example: OJUI-13-04TW for a self aligning version

For Straight bearing use **11** (see page 29.16)

For Self-Aligning bearing use **13** (see page 29.17)

For Low Clearance Straight use **31** (see page 29.16)

For Low Clearance Self-Aligning use **33** (see page 29.17)



Online lifetime calculation
www.igus.com

Load Data

Part No.	pmax. Dynamic Load			pmax. Static Load		
	P = 725 psi			P = 5075 psi		
	0°	90°	180°	0°	90°	180°
OJUI-XX-08TW	226	154	80	1585	1078	555
OJUI-XX-10TW	340	231	118	2378	1617	832
OJUI-XX-12TW	408	277	143	2854	1942	998
OJUI-XX-16TW	590	400	206	4123	2804	1443
OJUI-XX-20TW	1189	809	416	8323	5659	2912
OJUI-XX-24TW	1631	1109	571	11418	7765	3996
OJUI-XX-32TW	2900	1972	1015	20300	13804	7104

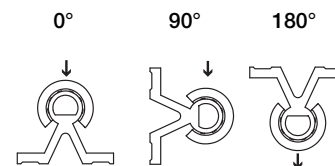

DryLin® R
Linear Guide Systems

PDF: www.igus.com/iglide-pdfs
CAD: www.igus.com/iglide-CAD
RoHS info: www.igus.com/RoHS

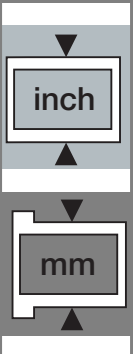



DryLin® R Flange Pillow Block, inch

Special Properties

- Flange housing made of anodized aluminum, square flange
- Liner JUI-02 made of iglide® J
- Can be fitted with iglide® T500 liner material for temperatures up to 356°F
- Low clearance liners optional

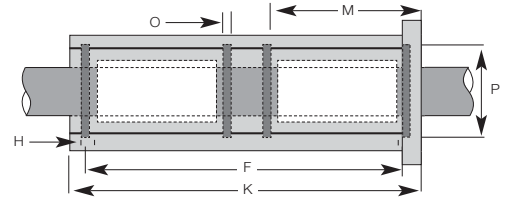
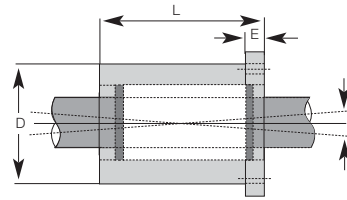
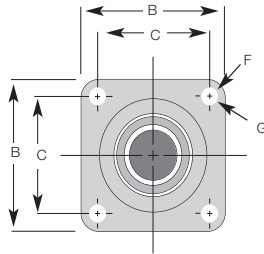

DryLin® R
Linear Guide Systems

Telephone 1-800-521-2747
1-401-438-7270
Fax



FJUI-XX, Pillow Blocks

Dimensions (inch)

Flange, Square

Part no.	Bearing ID	B	C	D	E	F Bolt Size	G	L
FJUI-□-08	1/2	1.63	1.25	1.25	.250	#8	.187	1.687
FJUI-□-12*	3/4	2.38	1.75	1.75	.375	#10	.219	2.067
FJUI-□-16*	1	2.75	2.125	2.25	.500	1/4	.281	2.812

Twin Flange, Square

Part no.	Bearing ID	B	C	D	E	F Bolt Size	G	L
FJUI-□-08TW	1/2	1.63	1.25	1.25	.250	#8	.187	3.375
FJUI-□-12TW	3/4	2.38	1.75	1.75	.375	#10	.219	4.188
FJUI-□-16TW	1	2.75	2.125	2.25	.500	1/4	.281	5.625



Supplement the part number with one of the following choices.

Example: FJUI-13-08TW for a self aligning version

For Straight bearing use 11 (see page 29.12)

For Self-Aligning bearing use 13 (see page 29.13)

For Low Clearance Straight use 31 (see page 29.12)

For Low Clearance Self-Aligning use 33 (see page 29.13)

FJUIT-01-XX, Twin Flange Pillow Block, Round, Low cost



Special Properties

- Flange housing made of anodized aluminum, round flange
- 2x liner JUI-01 made of iglide® J
- More sizes may be available upon request
- Can be fitted with iglide® T500 liner material for temperatures up to 356°F
- Low clearance liners optional

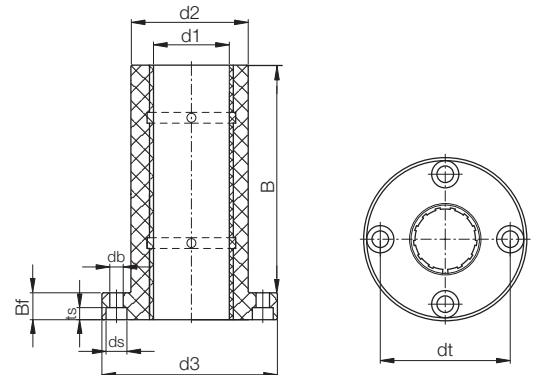

Dimensions (inch)

Part No.	d1	d2 ISO h7	d3	dt	B	Bf	ts	db	ds	Bolt Screw size
FJUIT-01-12	3/4	1.260	2.126	1.693	2.72	.433	.203	.219	.343	#10
FJUIT-01-16	1	1.575	2.441	2.000	3.98	.433	.203	.219	.343	#10

Internet: <http://www.igus.com>
email: sales@igus.com
QuickSpec: <http://www.igus.com/iglide-quickspec>

DryLin® S Aluminum Shaft, inch



Properties

Material: 6061-T6
Tolerance: +0/-0.001"
Straightness: .001"/ft
Hardness: 75 HB
Surface: hard-anodized
 mil-A-8625 Type III Class I
 < .002"

Layer Thickness: > .0016"
Surface Hardness: 450-550 HV
 approx. (60 RC)
Roughness: RMS = 4-20
Spec. Electr. Resistance: 4×10^{11} Ohm mm²/m
Chemical Resistance: 2 < pH < 9

Dimensions (inch)

Part No.	Design	Diameter	Max. Length*	Weight (lbs/ft)
AWI-04- L in inches	Solid	.2500	72	.057
AWI-06- L in inches	Solid	.3750	72	.130
AWI-08- L in inches	Solid	.5000	72	.231
AWI-10- L in inches	Solid	.6250	72	.361
AWI-12- L in inches	Solid	.7500	72	.519
AWI-16- L in inches	Solid	1.0000	72	.924
AWI-20- L in inches	Solid	1.2500	72	1.44
AWI-24- L in inches	Solid	1.5000	72	2.08
AWI-32- L in inches	Solid	2.0000	72	3.70



*Shaft supports available upon request

Longer sizes available upon request
Metric sizes are also available. See Page 29.61

DryLin® S Supported Aluminum Shaft, AWUI-XX



Properties

Material: 6063-T6
Surface: hard-anodized aluminum
 mil-A-8625 Type III Class I
 < .002"

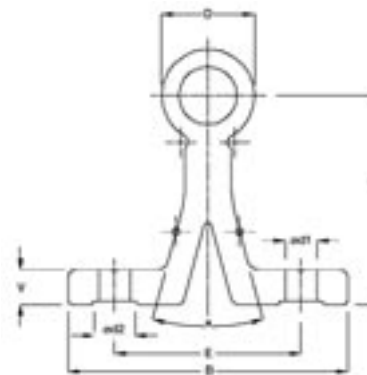
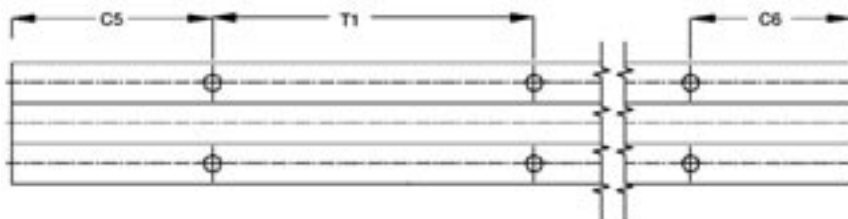

Dimensions (inch)

Part No.	D	B	H ±0.008	V	d1	d2	(°)	E ±.008	T1 Bore Spacing	C5/C6		Max. Length	Weight (lbs/ft)
										min.	max.		
AWUI-08- L in mm	.500 (-.006)	1.50	1.125	.190	.169	.217	30°	1.000	4.00	1	2.95	144	.6
AWUI-10- L in mm	.625 (.006)	1.62	1.125	.252	.193	.256	30°	1.125	4.00	1	3.95	144	.9
AWUI-12- L in mm	.750 (-.006)	1.75	1.500	.252	.220	.276	30°	1.250	6.00	1	3.95	144	1.2
AWUI-16- L in mm	1.000 (-.006)	2.13	1.750	.252	.280	.335	30°	1.500	6.00	1	3.95	144	1.5
AWUI-24- L in mm	1.500 (-.006)	3.00	2.500	.374	.343	.394	30°	2.250	8.00	1	3.95	144	2.6

Please contact igus for additional sizes
Order example: AWUI-16-500 corresponds to supported aluminum shaft diameter 1", 500 mm long

Other shaft materials available upon request

DryLin® R
 Linear Guide Systems

PDF: www.igus.com/iglide-pdfs
 CAD: www.igus.com/iglide-CAD
 RoHS info: www.igus.com/RoHS

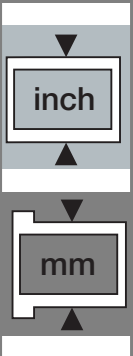



DryLin® R - Liner, mm

JUM-01, Standard, JUM-02 Short Standard

JUM-20, Low Clearance, JUM-22 Short Low Clearance

TUM-01, High Temp

DryLin® R
Linear Guide Systems

Telephone 1-800-521-2747
1-401-438-7270
Fax

Internet: <http://www.igus.com>
email: sales@igus.com
QuickSpec: <http://www.igus.com/iglide-quickspec>

Special Properties

- Very low coefficients of friction while running dry
- Very high wear resistance
- Maintenance-free
- Vibration dampening
- Very low moisture absorption
- High chemical resistance
- Suitable for rotating, oscillating and linear movements

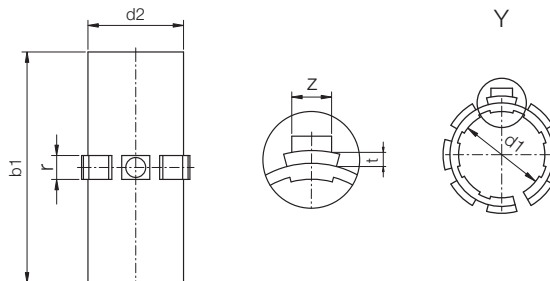

Part No.	d1	Tolerance*	d2	b1 JUM-01 standard	b1 JUM-02 short	r -0.1 -0.2	t -0.1	z -0.5	Weight (g)
----------	----	------------	----	--------------------------	-----------------------	-------------------	-----------	-----------	---------------

Standard Clearance

JUM-01/02-10	10	.0300 -.0700	12	29	25	3.0	0.8	2.5	0.98
JUM-01/02-12	12	.0300 -.0700	14	31	27	3.0	0.8	3.0	1.38
JUM-01/02-16	16	.0300 -.0700	18	35	29	3.5	0.8	3.5	1.82
JUM-01/02-20	20	.0300 -.0700	23	44	29	5.0	0.8	3.5	3.25
JUM-01/02-25	25	.0300 -.0700	28	57	39	5.0	0.8	4.0	5.80
JUM-01/02-30	30	.0400 -.0850	34	67	49	5.0	0.8	4.0	11.15
JUM-01/02-40	40	.0400 -.0850	44	79	59	6.0	1.3	5.0	18.01
JUM-01/02-50	50	.0500 -.1000	55	99	69	7.0	1.3	6.0	32.60

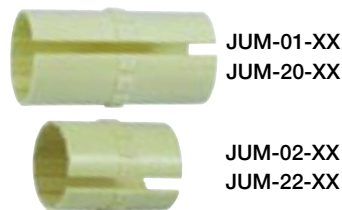

Material: iglide® J
Temp. range: -40°F to +194°F
Best Shaft Material: DryLin®
AWI hard anodized aluminum,
case hardened steel, 300 series
stainless

Low Clearance

JUM-20/22-10	10	.0150 -.0350	12	29	25	3.0	0.8	2.5	0.98
JUM-20/22-12	12	.0150 -.0350	14	31	27	3.0	0.8	3.0	1.38
JUM-20/22-16	16	.0150 -.0350	18	35	29	3.5	0.8	3.5	1.82
JUM-20/22-20	20	.0150 -.0350	23	44	29	5.0	0.8	3.5	3.25
JUM-20/22-25	25	.0150 -.0350	28	57	39	5.0	0.8	4.0	5.80
JUM-20/22-30	30	.0200 -.0425	34	67	49	5.0	0.8	4.0	11.15
JUM-20/22-40	40	.0200 -.0425	44	79	59	6.0	1.3	5.0	18.01
JUM-20/22-50	50	.0250 -.0500	55	99	69	7.0	1.3	6.0	32.60

High Temperature

TUM-01-12	12	.0300 -.0700	14	31	—	3.0	0.8	3.0	0.048
TUM-01-16	16	.0300 -.0700	18	35	—	3.5	0.8	3.5	0.064
TUM-01-20	20	.0300 -.0700	23	44	—	5.0	0.8	3.5	0.114
TUM-01-25	25	.0300 -.0700	28	57	—	5.0	0.8	4.0	0.203
TUM-01-30	30	.0400 -.0850	34	67	—	5.0	0.8	4.0	0.390



Material: iglide® T500
Temp. range: -148°F to +482°F
Best Shaft Material: Hardened
stainless and hard chrome plated
steel

Housing Bore for Liner JUM-01(02)/JUM-20(22)/TUM-01 Dimensions (mm)

Part No.	Nominal	di	B	B	r	t	f	z	
	Size		01/20 Standard	02/22 Short					
JUM-01(02)(20)(22)	10	H7	h10	29	26	+0.05	+0.1	+0.5	+0.2
JUM-01(02)(20)(22) / TUM-01-12	12			32	28				
JUM-01(02)(20)(22) / TUM-01-16	16			36	30				
JUM-01(02)(20)(22) / TUM-01-20	20			45	30				
JUM-01(02)(20)(22) / TUM-01-25	25			58	40				
JUM-01(02)(20)(22) / TUM-01-30	30			68	50				
JUM-01(02)(20)(22)	40			80	60				
JUM-01(02)(20)(22)	50			100	70				

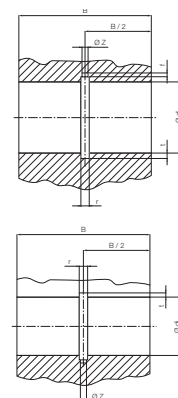

DryLin® R - Liner, mm

JUMO-01, Open, Standard

JUMO-20, Open, Low Clearance



Special Properties

- Open design for supported shafts
- Very low coefficients of friction while running dry
- Very high wear resistance
- Maintenance-free
- Vibration dampening
- Very low moisture absorption
- High chemical resistance
- Suitable for rotating, oscillating and linear movements
- Recommended housing bore H7

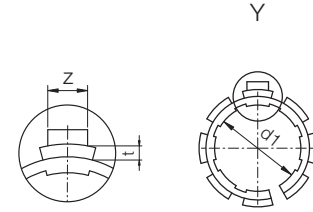
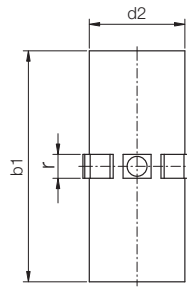

Part No.	d1	Tolerance*	d2	b1	W	r		t	z	Weight (g)
						+0.2	-0.1 -0.2			

Standard Clearance

JUMO-01-10	10	.0300 -.0700	12	29	7.3	3.0	0.8	2.5	0.8
JUMO-01-12	12	.0300 -.0700	14	31	9.0	3.0	0.8	3.0	1.7
JUMO-01-16	16	.0300 -.0700	18	35	11.6	3.5	0.8	3.5	2.5
JUMO-01-20	20	.0300 -.0700	23	44	12.0	5.0	0.8	3.5	4.2
JUMO-01-25	25	.0300 -.0700	28	57	14.5	5.0	0.8	4.0	5.9
JUMO-01-30	30	.0400 -.0850	34	67	16.6	5.0	0.8	4.0	12.0
JUMO-01-40	40	.0400 -.0850	44	79	21.0	6.0	1.3	5.0	20.0
JUMO-01-50	50	.0500 -.1000	55	99	25.5	7.0	1.3	6.0	36.0

JUMO-01/20



Material: iglide® J
Temp. range: -40°F to +194°F
Best Shaft Material: DryLin® AWI hard anodized aluminum, case hardened steel, 300 series stainless
 **Call for high temperature options

Low Clearance

JUMO-20-10	10	.0150 -.0350	12	29	7.3	3.0	0.8	2.5	0.8
JUMO-20-12	12	.0150 -.0350	14	31	9.0	3.0	0.8	3.0	1.7
JUMO-20-16	16	.0150 -.0350	18	35	11.6	3.5	0.8	3.5	2.5
JUMO-20-20	20	.0150 -.0350	23	44	12.0	5.0	0.8	3.5	4.2
JUMO-20-25	25	.0150 -.0350	28	57	14.5	5.0	0.8	4.0	5.9
JUMO-20-30	30	.0200 -.0425	34	67	16.6	5.0	0.8	4.0	12.0
JUMO-20-40	40	.0200 -.0425	44	79	21.0	6.0	1.3	5.0	20.0
JUMO-20-50	50	.0250 -.0500	55	99	25.5	7.0	1.3	6.0	36.0

Liners of the Series JUMO-01 are used in:

- ▶ OJUM-01, Page 29.36
- ▶ OJUM-03, Page 29.38
- ▶ OJUM-06, Page 29.46

* according to igus® testing method ▶ Page 29.57

DryLin® R
Linear Guide Systems

PDF: www.igus.com/iglide-pdfs
 CAD: www.igus.com/iglide-CAD
 RoHS info: www.igus.com/RoHS



inch

mm

Installation Drawings

Housing Bore, Dimensions (mm)

Part No.	Nominal	di	B	r	t	f	z	W
	Size	H7	h10	+0.05	+0.1	+0.5	+0.2	+0.2
JUMO-01 / JUMO-20-10	10	12	29	3.0	0.8	1.0	2.6	7.3
JUMO-01 / JUMO-20-12	12	14	32	3.0	0.8	1.5	3.1	9.0
JUMO-01 / JUMO-20-16	16	18	36	3.5	0.8	1.7	3.6	11.6
JUMO-01 / JUMO-20-20	20	23	45	5.0	0.8	2.0	3.6	12.0
JUMO-01 / JUMO-20-25	25	28	58	5.0	0.8	2.0	4.1	14.5
JUMO-01 / JUMO-20-30	30	34	68	5.0	0.8	2.0	4.1	16.6
JUMO-01 / JUMO-20-40	40	44	80	6.0	1.3	2.5	5.1	21.0
JUMO-01 / JUMO-20-50	50	55	100	7.0	1.3	2.5	6.1	25.5

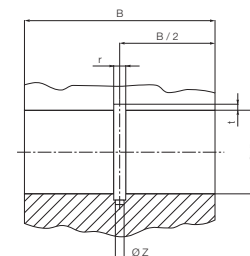
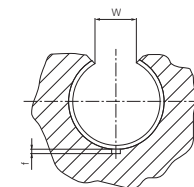

* according to igus® testing method ▶ Page 29.57



Special Properties

- Made of iglide® T500 (in two parts)
- Recommended for high temperature applications over 176°F up to 482°F (80°C up to 250°C)
- High chemical resistance
- Maintenance-free
- Very low moisture absorption
- Available for all adapters and pillow blocks (Ø12 mm - 30 mm)
- Recommended for use on stainless steel or hard chromed steel

Liners of the Series JUM-01 are used in:

- RJUM-01, Page 29.28
- RJUM-03, Page 29.30
- RJUM-06, Page 29.43
- TJUM-01, Page 29.32
- TJUM-03, Page 29.34
- FJUM-01, Page 29.49
- FJUM-02, Page 29.50

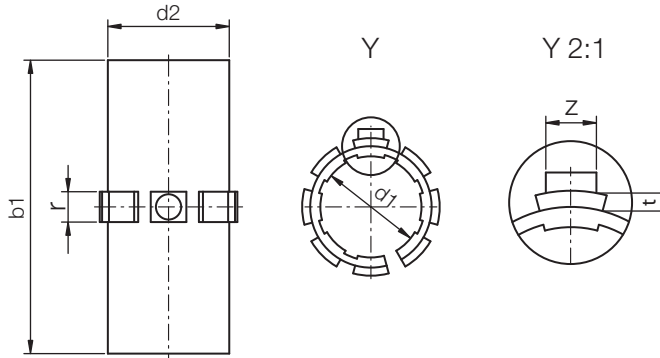

Dimensions (mm)

Part No.	d1	Tolerance*	d2	b1	r -0.1/-0.2	t -0.1	z -0.5	Weight (oz) -0.2
TUMO-01-10**	10	.0000 - .0700	12	28	3.0	0.8	2.5	0.035
TUM-01-12	12	.0300 - .0700	14	31	3.0	0.8	3.0	0.048
TUM-01-16	16	.0300 - .0700	18	35	3.5	0.8	3.5	0.064
TUM-01-20	20	.0300 - .0700	23	44	5.0	0.8	3.5	0.114
TUM-01-25	25	.0300 - .0700	28	57	5.0	0.8	4.0	0.203
TUM-01-30	30	.0400 - .0850	34	67	5.0	0.8	4.0	0.390

* according to iglus® testing method ➤ Page 29.57

Housing bore Dimensions (mm)

Part No.	Nominal	di	B	r	t	f	z
	Size	H7	h10	+0.05	+0.1	+0.5	+0.2
TUMO-01-10**	10	12	29	3.0	1.0	1.0	2.6
TUM-01-12	12	14	32	3.0	1.0	1.5	3.1
TUM-01-16	16	18	36	3.5	1.0	1.7	3.6
TUM-01-20	20	23	45	5.0	1.0	2.0	3.6
TUM-01-25	25	28	58	5.0	1.0	2.0	4.1
TUM-01-30	30	34	68	5.0	1.0	2.0	4.1

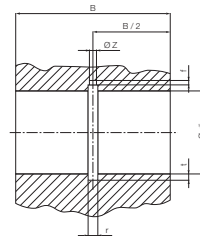

** Only available in the open design

Liners of Series TUM-01 can be used in all housings designed for DryLin® R standard series. (Call for assistance)



Special Properties



- Plain bearing made of all plastic
- Dimensions corresponds to the standard for recirculating ball bearings
- Recommended housing bore H7
- Secured by retaining clips according to DIN 471 or 472 (not included in delivery)
- Designed as a press-fit part, it will be oversized in free-state

Liners of the Series

RJM-01 are used in:

- ▶ RQA-04, Page 29.53
- ▶ RTA-04, Page 29.54
- ▶ RGA-04, Page 29.55
- ▶ RGAS-04, Page 29.56

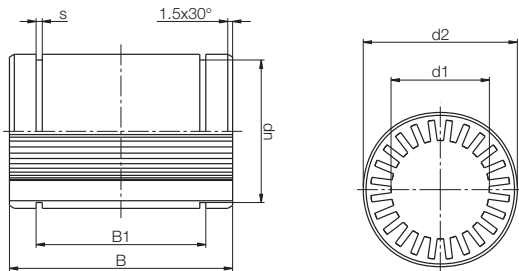

Dimensions (mm)

Part No.	d1	d2	B	B1	s	dn
RJM-01-08	8	16	25	16.2	1.10	15.2
RJM-01-10	10	19	29	21.6	1.30	17.5
RJM-01-12	12	22	32	22.6	1.30	20.5
RJM-01-16	16	26	36	24.6	1.30	24.2
RJM-01-20	20	32	45	31.2	1.60	29.6
RJM-01-25	25	40	58	43.7	1.85	36.5
RJM-01-30	30	47	68	51.7	1.85	43.5
RJM-01-40	40	62	80	60.3	2.15	57.8
RJM-01-50	50	75	100	77.3	2.65	70.5

* according to igus® testing method ▶ Page 29.57

Technical Data

Part No.	Nominal Size	Housing Bore		Tolerance for d1	pmax. Dynamic Load p = 2.5 MPa (N)	pmax. Static Load p = 17.5 MPa (N)	Weight (g)
		Max.	Min.				
RJM-01-08	8	16.018	16.000	.0250 - .0610	250	1750	9
RJM-01-10	10	19.021	19.000	.0320 - .0750	363	2538	14
RJM-01-12	12	22.021	22.000	.0320 - .0750	480	3360	21
RJM-01-16	16	26.021	26.000	.0320 - .0750	720	5040	28
RJM-01-20	20	32.025	32.000	.0400 - .0920	1125	7875	49
RJM-01-25	25	40.025	40.000	.0400 - .0920	1813	12688	108
RJM-01-30	30	47.025	47.000	.0400 - .0920	2550	17850	162
RJM-01-40	40	62.030	62.000	.0500 - .1120	4000	28000	334
RJM-01-50	50	75.030	75.000	.0600 - .1340	6250	43750	579

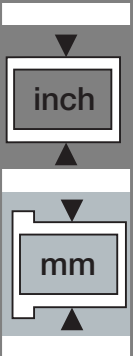



Special Properties

- Closed, anodized aluminum adapter
- Dimensions equivalent to the standard for recirculating ball bearings
- Equipped with JUM-01 liner made of iglide® J
- Secured by retaining clips according to DIN 471 or 472 (not included in delivery)
- Recommended housing bore H7

RJUM-01 Bearings are used in:

- RQA-01, Page 29.53
- RTA-01, Page 29.54
- RGA-01, Page 29.55
- RGAS-01, Page 29.56

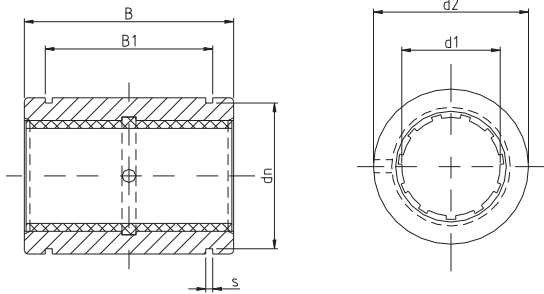

Dimensions (mm)

Part No.	d1	d2 h7	B h10	B1	s	dn
RJZM-01-05*	5	12	22	14.2	1.10	11.5
RJZM-01-08*	8	16	25	16.2	1.10	15.2
RJUM-01-10	10	19	29	21.6	1.30	17.5
RJUM-01-12	12	22	32	22.6	1.30	20.5
RJUM-01-16	16	26	36	24.6	1.30	24.2
RJUM-01-20	20	32	45	31.2	1.60	29.6
RJUM-01-25	25	40	58	43.7	1.85	36.5
RJUM-01-30	30	47	68	51.7	1.85	43.5
RJUM-01-40	40	62	80	60.3	2.15	57.8
RJUM-01-50	50	75	100	77.3	2.65	70.5

Housing Bore Dimensions

Nominal Size	METRIC	
	Min.	Max.
8	16.000	16.018
10	19.000	19.021
12	22.000	22.021
16	26.000	26.021
20	32.000	32.025
25	40.000	40.025
30	47.000	47.025
40	62.000	62.030
50	75.000	75.030

* nominal width under 10 mm are delivered with pressfit cylindrical plain bearings

* according to iglus® testing method ➤ Page 29.57

Load Data

Part No.	Nominal Size	Tolerance** Bearing Inner Diameter	pmax. Dynamic Load	pmax. Static Load	Weight (g)
			P = 5 MPa (N)	P = 35 MPa (N)	
RJZM-01-05*	5	.0250 - .0600	525	3675	5
RJZM-01-08*	8	.0320 - .0700	960	6720	9
RJUM-01-10	10	.0300 - .0880	725	5075	14
RJUM-01-12	12	.0300 - .0880	960	6720	21
RJUM-01-16	16	.0300 - .0880	1440	10080	28
RJUM-01-20	20	.0300 - .0910	2250	15750	49
RJUM-01-25	25	.0300 - .0910	3625	25375	108
RJUM-01-30	30	.0400 - .1100	5100	35700	162
RJUM-01-40	40	.0400 - .1150	8000	56000	334
RJUM-01-50	50	.0500 - .1300	12500	87500	579

DryLin® R Straight, Low Clearance Linear Bearing RJUM-21, mm



Special Properties

- Closed, anodized aluminum adapter
- Dimensions equivalent to the standard for recirculating ball bearings
- Equipped with JUM-20 liner made of iglide® J
- Secured by retaining clips according to DIN 471 or 472 (not included in delivery)
- Recommended housing bore H7

RJUM-21 Bearings are used in:

- ▶ RQA-01, Page 29.53
- ▶ RTA-01, Page 29.54
- ▶ RGA-01, Page 29.55
- ▶ RGAS-01, Page 29.56

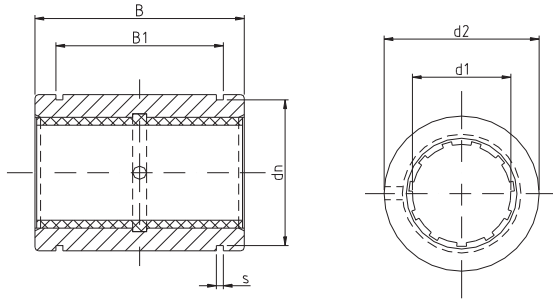

Dimensions (mm)

Part No.	d1	d2 h7	B h10	B1	s	dn
RJZM-21-05*	5	12	22	14.2	1.10	11.5
RJZM-21-08*	8	16	25	16.2	1.10	15.2
RJUM-21-10	10	19	29	21.6	1.30	17.5
RJUM-21-12	12	22	32	22.6	1.30	20.5
RJUM-21-16	16	26	36	24.6	1.30	24.2
RJUM-21-20	20	32	45	31.2	1.60	29.6
RJUM-21-25	25	40	58	43.7	1.85	36.5
RJUM-21-30	30	47	68	51.7	1.85	43.5
RJUM-21-40	40	62	80	60.3	2.15	57.8
RJUM-21-50	50	75	100	77.3	2.65	70.5

* nominal width under 10 mm are delivered with pressfit cylindrical plain bearings

* according to iglus® testing method ▶ Page 29.57

Load Data

Part No.	Nominal Size	Tolerance** Bearing Inner Diameter	pmax.	pmax.	Weight (g)
			Dynamic Load P = 5 MPa (N)	Static Load P = 35 MPa (N)	
RJZM-21-05*	5	.0125 - .0300	525	3675	5
RJZM-21-08*	8	.0160 - .0350	960	6720	9
RJUM-21-10	10	.0150 - .0440	725	5075	14
RJUM-21-12	12	.0150 - .0440	960	6720	21
RJUM-21-16	16	.0150 - .0440	1440	10080	28
RJUM-21-20	20	.0150 - .0440	2250	15750	49
RJUM-21-25	25	.0150 - .0440	3625	25375	108
RJUM-21-30	30	.0200 - .0550	5100	35700	162
RJUM-21-40	40	.0200 - .0575	8000	56000	334
RJUM-21-50	50	.0250 - .0650	12500	87500	579

DryLin® R
Linear Guide Systems

PDF: www.igus.com/iglide-pdfs
CAD: www.igus.com/iglide-CAD
RoHS info: www.igus.com/RoHS

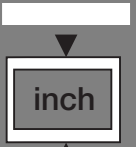



Special Properties

- Closed aluminum adapter with
 - reduced outer diameter
 - spherical area on the outer diameter for automatic alignment compensation
 - O-rings for elastic seating
 - hard-anodized
- Equipped with JUM-01 liner made of iglide® J
- Dimensions otherwise equivalent to the standard for recirculating ball bearings
- Secured by retaining clips according to DIN 471 or 472 (not included in delivery)
- Recommended housing bore H7
- O-ring grease recommended for install

RJUM-03 Bearings are used in:

- RQA-01, Page 29.53
- RTA-01, Page 29.54
- RGA-01, Page 29.55
- RGAS-01, Page 29.56

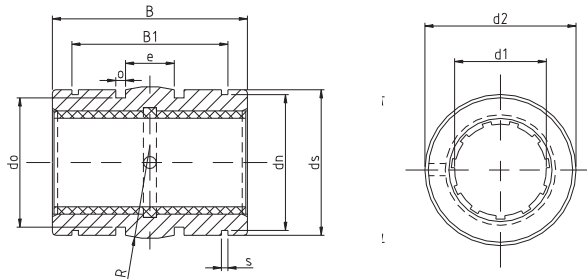

Dimensions (mm)

Part No.	d1	d2	B	B1	s	dn	ds	do	o	e	R
		h8	h10	H10	H10	h10	h10	h10	+0.1		
RJZM-03-08*	8	15.8	24.9	16.4	1.10	15.0	15.5	13.2	1.86	5.0	20.0
RJUM-03-10	10	18.8	28.9	21.8	1.30	17.5	18.5	15.4	1.86	5.0	13.0
RJUM-03-12	12	21.8	31.9	22.8	1.30	20.5	21.5	18.4	1.86	6.0	18.0
RJUM-03-16	16	25.8	35.9	24.9	1.30	24.2	25.5	20.4	2.86	8.0	32.0
RJUM-03-20	20	31.8	44.8	31.5	1.60	29.6	31.5	26.4	2.86	10.0	50.0
RJUM-03-25	25	39.8	57.8	44.1	1.85	36.5	39.5	34.4	2.86	12.5	39.0
RJUM-03-30	30	46.7	67.8	52.1	1.85	43.5	46.0	41.4	2.86	15.0	57.0
RJUM-03-40	40	61.7	79.8	60.9	2.15	57.8	61.0	56.4	2.86	20.0	100.0
RJUM-03-50	50	74.7	99.8	78.0	2.65	70.5	74.0	69.4	2.86	25.0	157.0

Housing Bore Dimensions

Nominal Size	METRIC	
	Min.	Max.
8	16.000	16.018
10	19.000	19.021
12	22.000	22.021
16	26.000	26.021
20	32.000	32.025
25	40.000	40.025
30	47.000	47.025
40	62.000	62.030
50	75.000	75.030

Load Data

Part No.	Nominal Size	Housing Bore i.d. h7 (mm)	Tolerance** Bearing Inner Diameter	pmax. Dynamic Load P = 5 MPa (N)	pmax. Static Load P = 35 MPa (N)	Weight (g)
RJZM-03-08*	8	16	.0320 - .0700	960	6720	8
RJUM-03-10	10	19	.0300 - .0880	725	5075	11
RJUM-03-12	12	22	.0300 - .0880	960	6720	17
RJUM-03-16	16	26	.0300 - .0880	1440	10080	23
RJUM-03-20	20	32	.0300 - .0910	2250	15750	44
RJUM-03-25	25	40	.0300 - .0910	3625	25375	92
RJUM-03-30	30	47	.0400 - .1100	5100	35700	145
RJUM-03-40	40	62	.0400 - .1150	8000	56000	311
RJUM-03-50	50	75	.0500 - .1300	12500	87500	542

* nominal width under 10 mm are delivered with pressfit cylindrical plain bearings

* according to iglus® testing method ➤ Page 29.57

DryLin® R Self-Aligning, Low Clearance Linear Bearing RJUM-23, mm



Special Properties

- Closed aluminum adapter with
 - reduced outer diameter
 - spherical area on the outer diameter for automatic alignment compensation
 - O-rings for elastic seating
 - hard-anodized
- Equipped with JUM-20 liner made of iglide® J
- Dimensions otherwise equivalent to the standard for recirculating ball bearings
- Secured by retaining clips according to DIN 471 or 472 (not included in delivery)
- Recommended housing bore H7
- O-ring grease recommended for install

RJUM-23 Bearings are used in:

- ▶ RQA-01, Page 29.53
- ▶ RTA-01, Page 29.54
- ▶ RGA-01, Page 29.55
- ▶ RGAS-01, Page 29.56

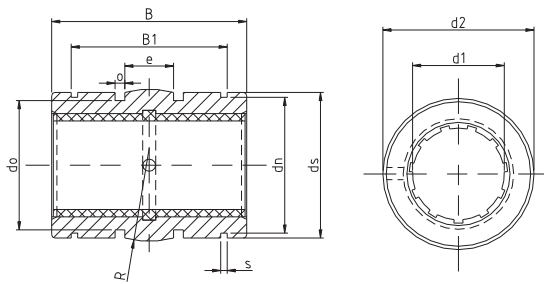

Dimensions (mm)

Part No.	d1	d2 h8	B h10	B1 H10	s H10	dn h10	ds h10	do h10	o +0.1	e	R
RJZM-23-08*	8	15.8	24.9	16.4	1.10	15.0	15.5	13.2	1.86	5.0	20.0
RJUM-23-10	10	18.8	28.9	21.8	1.30	17.5	18.5	15.4	1.86	5.0	13.0
RJUM-23-12	12	21.8	31.9	22.8	1.30	20.5	21.5	18.4	1.86	6.0	18.0
RJUM-23-16	16	25.8	35.9	24.9	1.30	24.2	25.5	20.4	2.86	8.0	32.0
RJUM-23-20	20	31.8	44.8	31.5	1.60	29.6	31.5	26.4	2.86	10.0	50.0
RJUM-23-25	25	39.8	57.8	44.1	1.85	36.5	39.5	34.4	2.86	12.5	39.0
RJUM-23-30	30	46.7	67.8	52.1	1.85	43.5	46.0	41.4	2.86	15.0	57.0
RJUM-23-40	40	61.7	79.8	60.9	2.15	57.8	61.0	56.4	2.86	20.0	100.0
RJUM-23-50	50	74.7	99.8	78.0	2.65	70.5	74.0	69.4	2.86	25.0	157.0

Load Data

Part No.	Nominal Size	Housing Bore i.d. (mm)	Tolerance** Bearing Inner Diameter	pmax.	pmax.	Weight (g)
				Dynamic Load P = 5 MPa (N)	Static Load P = 35 MPa (N)	
RJZM-23-08*	8	16	.0160 - .0350	960	6720	8
RJUM-23-10	10	19	.0150 - .0440	725	5075	11
RJUM-23-12	12	22	.0150 - .0440	960	6720	17
RJUM-23-16	16	26	.0150 - .0440	1440	10080	23
RJUM-23-20	20	32	.0150 - .0455	2250	15750	44
RJUM-23-25	25	40	.0150 - .0455	3625	25375	92
RJUM-23-30	30	47	.0200 - .0550	5100	35700	145
RJUM-23-40	40	62	.0200 - .0575	8000	56000	311
RJUM-23-50	50	75	.0250 - .0650	12500	87500	542

* nominal width under 10 mm are delivered with pressfit cylindrical plain bearings

* according to igus® testing method ▶ Page 29.57

DryLin® R
Linear Guide Systems

PDF: www.igus.com/iglide-pdfs
CAD: www.igus.com/iglide-CAD
RoHS info: www.igus.com/RoHS





DryLin® R Straight, Split Linear Bearing TJUM-01, mm

DryLin® R
Linear Guide Systems

Telephone 1-800-521-2747
1-401-438-7270
Fax

Internet: <http://www.igus.com>
email: sales@igus.com
QuickSpec: <http://www.igus.com/iglide-quickspec>



Special Properties

- Split, anodized aluminum adapter
- Dimensions equivalent to the standard for recirculating ball bearings
- Equipped with JUM-01 liner made of iglide® J
- Secured by retaining clips according to DIN 471 or 472 (not included in delivery)
- Recommended housing bore H7

TJUM-01 Bearings are used in:

- ▶ RQA-01, Page 29.53
- ▶ RTA-01, Page 29.54
- ▶ RGA-01, Page 29.55
- ▶ RGAS-01, Page 29.56

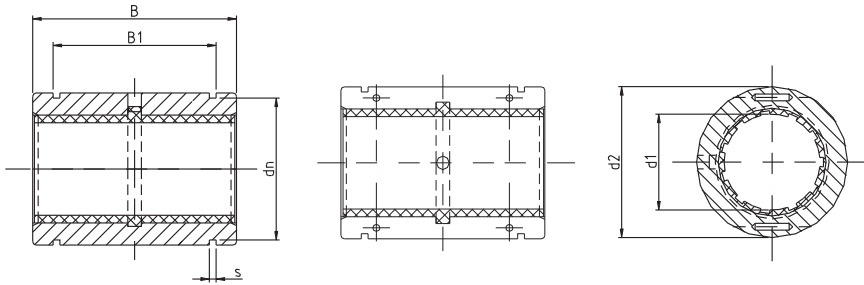

Housing Bore Dimensions

Nominal Size	METRIC	
	Min.	Max.
8	16.000	16.018
10	19.000	19.021
12	22.000	22.021
16	26.000	26.021
20	32.000	32.025
25	40.000	40.025
30	47.000	47.025
40	62.000	62.030
50	75.000	75.030

Dimensions (mm)

Part No.	d1	d2	Tolerance	B h10	B1 H10	s H10	dn
TJUM-01-10	10	19	-.0200 /-.0400	29	21.6	1.30	17.5
TJUM-01-12	12	22	-.0200 /-.0400	32	22.6	1.30	20.5
TJUM-01-16	16	26	-.0200 /-.0400	36	24.6	1.30	24.2
TJUM-01-20	20	32	-.0200 /-.0450	45	31.2	1.60	29.6
TJUM-01-25	25	40	-.0300 /-.0550	58	43.7	1.85	36.5
TJUM-01-30	30	47	-.0300 /-.0550	68	51.7	1.85	43.5
TJUM-01-40	40	62	-.0300 /-.0600	80	60.3	2.15	57.8
TJUM-01-50	50	75	-.0300 /-.0600	100	77.3	2.65	70.5

Load Data

Part No.	Nominal Size	Tolerance* Bearing Inner Diameter	pmax. Dynamic Load P = 5 MPa (N)	pmax. Static Load P = 35 MPa (N)	Weight (g)
TJUM-01-10	10	.0300 - .0920	725	5075	14
TJUM-01-12	12	.0300 - .0970	960	6720	19
TJUM-01-16	16	.0300 - .0970	1440	10080	27
TJUM-01-20	20	.0300 - .1030	2250	15750	49
TJUM-01-25	25	.0300 - .1030	3625	25375	106
TJUM-01-30	30	.0400 - .1240	5100	35700	166
TJUM-01-40	40	.0400 - .1240	8000	56000	347
TJUM-01-50	50	.0500 - .1460	12500	87500	577

* according to iglus® testing method ▶ Page 29.57

DryLin® R Straight, Split, Low Clearance Linear Bearing TJUM-21, mm



Special Properties

- Split, anodized aluminum adapter
- Dimensions equivalent to the standard for recirculating ball bearings
- Equipped with JUM-20 liner made of iglide® J
- Secured by retaining clips according to DIN 471 or 472 (not included in delivery)
- Recommended housing bore H7

TJUM-21 Bearings are used in:

- ▶ RQA-01, Page 29.53
- ▶ RTA-01, Page 29.54
- ▶ RGA-01, Page 29.55
- ▶ RGAS-01, Page 29.56

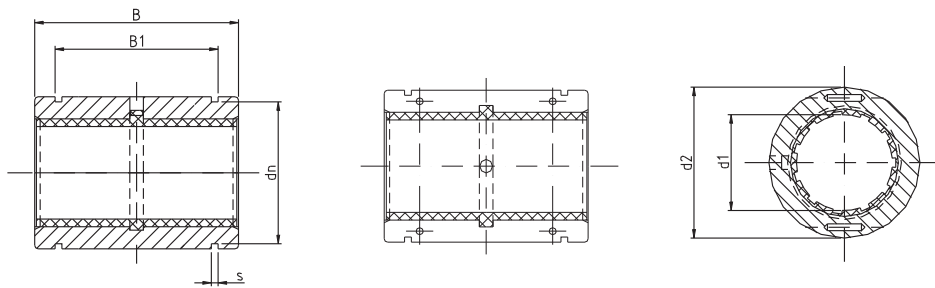

Dimensions (mm)

Part No.	d1	d2	Tolerance	B	B1	s	dn
				h10	H10	H10	
TJUM-21-10	10	19	-.0200 /-.0400	29	21.6	1.30	17.5
TJUM-21-12	12	22	-.0200 /-.0400	32	22.6	1.30	20.5
TJUM-21-16	16	26	-.0200 /-.0400	36	24.6	1.30	24.2
TJUM-21-20	20	32	-.0200 /-.0450	45	31.2	1.60	29.6
TJUM-21-25	25	40	-.0300 /-.0550	58	43.7	1.85	36.5
TJUM-21-30	30	47	-.0300 /-.0550	68	51.7	1.85	43.5
TJUM-21-40	40	62	-.0300 /-.0600	80	60.3	2.15	57.8
TJUM-21-50	50	75	-.0300 /-.0600	100	77.3	2.65	70.5

Load Data

Part No.	Nominal Size	Tolerance* Bearing Inner Diameter	pmax. Dynamic Load	pmax. Static Load	Weight (g)
			P = 5 MPa (N)	P = 35 MPa (N)	
TJUM-21-10	10	.0150 - .0460	725	5075	14
TJUM-21-12	12	.0150 - .0485	960	6720	19
TJUM-21-16	16	.0150 - .0485	1440	10080	27
TJUM-21-20	20	.0150 - .0515	2250	15750	49
TJUM-21-25	25	.0150 - .0515	3625	25375	106
TJUM-21-30	30	.0200 - .0620	5100	35700	166
TJUM-21-40	40	.0200 - .0620	8000	56000	347
TJUM-21-50	50	.0250 - .0730	12500	87500	577

* according to iglus® testing method ▶ Page 29.57

DryLin® R
Linear Guide Systems

PDF: www.igus.com/iglide-pdfs
CAD: www.igus.com/iglide-CAD
RoHS info: www.igus.com/RoHS

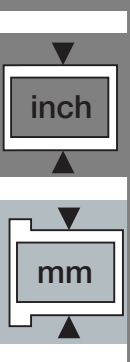



DryLin® R Self-Aligning, Split Linear Bearing TJUM-03, mm

DryLin® R
Linear Guide Systems

Telephone 1-800-521-2747
1-401-438-7270
Fax

Internet: <http://www.igus.com>
email: sales@igus.com
QuickSpec: <http://www.igus.com/iglide-quickspec>



Special Properties

- Split aluminum adapter with
 - spherical area on the outer diameter for self-alignment purposes
 - O-rings for elastic seating
- Dimensions otherwise equivalent to the standard for recirculating ball bearings
- Equipped with JUM-01 liner made of iglide® J
- Secured by retaining clips according to DIN 471 or 472 (not included in delivery)
- Recommended housing bore H7
- O-ring grease recommended for install

TJUM-03 Bearings are used in:

- RQA-01, Page 29.53
- RTA-01, Page 29.54
- RGA-01, Page 29.55
- RGAS-01, Page 29.56

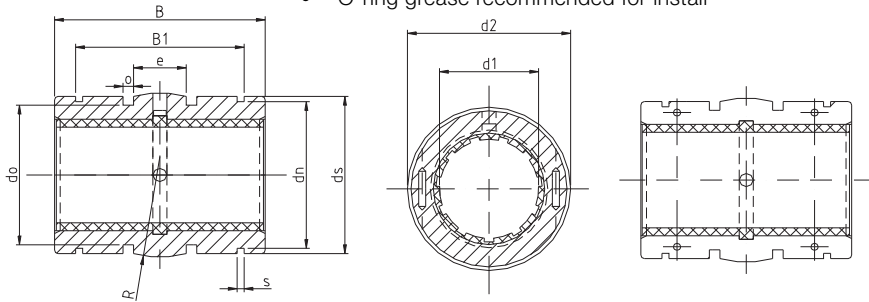

Housing Bore Dimensions

Nominal Size	METRIC	
	Min.	Max.
8	16.000	16.018
10	19.000	19.021
12	22.000	22.021
16	26.000	26.021
20	32.000	32.025
25	40.000	40.025
30	47.000	47.025
40	62.000	62.030
50	75.000	75.030

Dimensions (mm)

Part No.	d1	d2	B		s	dn		ds	do	o		R
			h10	H10		h10	h10			+0.2	0.4	
TJUM-03-10	10	19 -0.020-0.040	28.9	21.8	1.30	17.5	18.5	15.4	1.86	5.0	13.0	
TJUM-03-12	12	22 -0.020-0.040	31.9	22.8	1.30	20.5	21.5	18.4	1.86	6.0	18.0	
TJUM-03-16	16	26 -0.020-0.040	35.9	24.9	1.30	24.2	25.5	20.4	2.86	8.0	32.0	
TJUM-03-20	20	32 -0.020-0.045	44.8	31.5	1.60	29.6	31.5	26.4	2.86	10.0	50.0	
TJUM-03-25	25	40 -0.030-0.055	57.8	44.1	1.85	36.5	39.5	34.4	2.86	12.5	39.0	
TJUM-03-30	30	47 -0.030-0.055	67.8	52.1	1.85	43.5	46.0	41.4	2.86	15.0	57.0	
TJUM-03-40	40	62 -0.030-0.060	79.8	60.9	2.15	57.8	61.0	56.4	2.86	20.0	100.0	
TJUM-03-50	50	75 -0.030-0.060	99.8	78.0	2.65	70.5	74.0	69.4	2.86	25.0	157.0	

Load Data

Part No.	Nominal Size	Tolerance* Bearing Inner Diameter	pmax.		Weight (g)
			Dynamic Load P = 5 MPa (N)	Static Load P = 35 MPa (N)	
TJUM-03-10	10	.0300 - .0920	725	5075	11
TJUM-03-12	12	.0300 - .0970	960	6720	17
TJUM-03-16	16	.0300 - .0970	1440	10080	23
TJUM-03-20	20	.0300 - .1030	2250	15750	44
TJUM-03-25	25	.0300 - .1030	3625	25375	92
TJUM-03-30	30	.0400 - .1240	5100	35700	145
TJUM-03-40	40	.0400 - .1240	8000	56000	311
TJUM-03-50	50	.0500 - .1460	12500	87500	542

* according to igus® testing method ➤ Page 29.57

DryLin® R Self-Aligning, Split, Low Clearance Linear Bearing - TJUM-23, mm



Special Properties

- Split aluminum adapter with
 - spherical area on the outer diameter for self-alignment purposes
 - O-rings for elastic seating
- Dimensions otherwise equivalent to the standard for recirculating ball bearings
- Equipped with JUM-20 liner made of iglide® J
- Secured by retaining clips according to DIN 471 or 472 (not included in delivery)
- Recommended housing bore H7
- O-ring grease recommended for install

TJUM-23 Bearings are used in:

- ▶ RQA-01, Page 29.53
- ▶ RTA-01, Page 29.54
- ▶ RGA-01, Page 29.55
- ▶ RGAS-01, Page 29.56

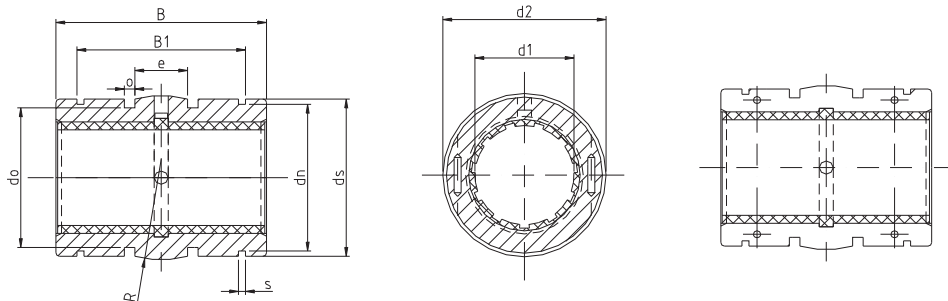

Dimensions (mm)

Part No.	d1	d2	B h10	B1 H10	s H10	dn h10	ds h10	do +0.2	o 0.4	e	R
TJUM-23-10	10	19 -0.020-0.040	28.9	21.8	1.30	17.5	18.5	15.4	1.86	5.0	13.0
TJUM-23-12	12	22 -0.020-0.040	31.9	22.8	1.30	20.5	21.5	18.4	1.86	6.0	18.0
TJUM-23-16	16	26 -0.020-0.040	35.9	24.9	1.30	24.2	25.5	20.4	2.86	8.0	32.0
TJUM-23-20	20	32 -0.020-0.045	44.8	31.5	1.60	29.6	31.5	26.4	2.86	10.0	50.0
TJUM-23-25	25	40 -0.030-0.055	57.8	44.1	1.85	36.5	39.5	34.4	2.86	12.5	39.0
TJUM-23-30	30	47 -0.030-0.055	67.8	52.1	1.85	43.5	46.0	41.4	2.86	15.0	57.0
TJUM-23-40	40	62 -0.030-0.060	79.8	60.9	2.15	57.8	61.0	56.4	2.86	20.0	100.0
TJUM-23-50	50	75 -0.030-0.060	99.8	78.0	2.65	70.5	74.0	69.4	2.86	25.0	157.0

Load Data

Part No.	Nominal Size	Tolerance* Bearing Inner Diameter	pmax. Dynamic Load P = 5 MPa (N)	pmax. Static Load P = 35 MPa (N)	Weight (g)
TJUM-23-10	10	.0150 - .0460	725	5075	11
TJUM-23-12	12	.0150 - .0485	960	6720	17
TJUM-23-16	16	.0150 - .0485	1440	10080	23
TJUM-23-20	20	.0150 - .0515	2250	15750	44
TJUM-23-25	25	.0150 - .0515	3625	25375	92
TJUM-23-30	30	.0200 - .0620	5100	35700	145
TJUM-23-40	40	.0200 - .0620	8000	56000	311
TJUM-23-50	50	.0250 - .0730	12500	87500	542

* according to iglus® testing method ▶ Page 29.57

DryLin® R
Linear Guide Systems

PDF: www.igus.com/iglide-pdfs
CAD: www.igus.com/iglide-CAD
RoHS info: www.igus.com/RoHS





DryLin® R Straight, Open Linear Bearing - OJUM-01, mm

DryLin® R
Linear Guide Systems

Telephone 1-800-521-2747
1-401-438-7270
Fax

Internet: <http://www.igus.com>
email: sales@igus.com
QuickSpec: <http://www.igus.com/iglide-quickspec>



Special Properties

- Open, anodized aluminum adapter for supported shafts
- Dimensions equivalent to the standard for recirculating ball bearings
- Equipped with JUMO liner made of iglide® J
- Recommended housing bore H7
- Secure the bearing with set screws (not included in the delivery)

OJUM-01 Bearings are used in:

- OQA-01, Page 29.53
- OTA-01, Page 29.54
- OGA-01, Page 29.55
- OGAS-01, Page 29.56

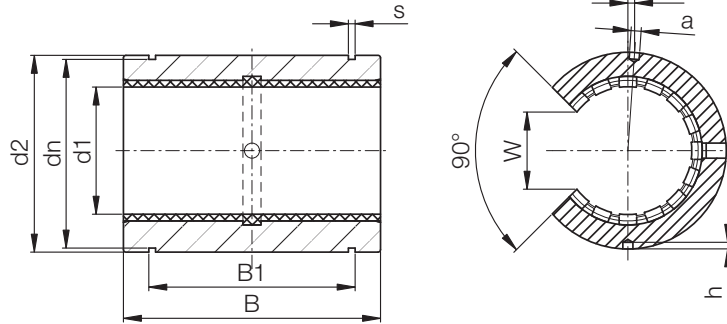

Housing Bore Dimensions

Nominal Size	METRIC	
	Min.	Max.
8	16.000	16.018
10	19.000	19.021
12	22.000	22.021
16	26.000	26.021
20	32.000	32.025
25	40.000	40.025
30	47.000	47.025
40	62.000	62.030
50	75.000	75.030

Dimensions (mm)

Part No.	d1	d2	B	W	a	dn	B1	s	f	h
		h7								
OJUM-01-10	10	19	29	7.3	0.0	17.5	21.6	1.30	0	1.2
OJUM-01-12	12	22	32	9.0	3.0	20.5	22.6	1.30	1.33 (7°)	1.2
OJUM-01-16	16	26	36	11.6	2.2	24.2	24.6	1.30	0	1.2
OJUM-01-20	20	32	45	12.0	2.2	29.6	31.2	1.60	0	1.2
OJUM-01-25	25	40	58	14.5	3.0	36.5	43.7	1.85	-1.5 (-4.3°)	1.5
OJUM-01-30	30	47	68	16.6	3.0	43.5	51.7	1.85	2 (4.9°)	2.0
OJUM-01-40	40	62	80	21.0	3.0	57.8	60.3	2.15	1.5 (2.8°)	2.0
OJUM-01-50	50	75	100	25.5	5.0	70.5	77.3	2.65	2.5 (3.8°)	2.0

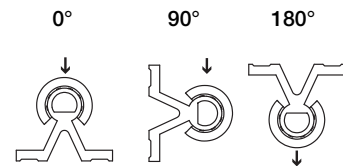

Load Data

Part No.	Nominal Size	Tolerance* Bearing Inner Diameter	pmax. Dynamic Load P = 5 MPa (N)			pmax. Static Load P = 35 MPa (N)			Weight (g)
			0°	90°	180°	0°	90°	180°	
			OJUM-01-10	10	.0300 - .0880	725	500	196	
OJUM-01-12	12	.0300 - .0880	960	635	240	6720	4445	1680	15
OJUM-01-16	16	.0300 - .0880	1440	990	396	10080	6943	2772	21
OJUM-01-20	20	.0300 - .0910	2250	1800	900	15750	12600	6300	42
OJUM-01-25	25	.0300 - .0910	3625	2953	1523	25375	20670	10658	70
OJUM-01-30	30	.0400 - .1100	5100	4250	2278	35700	29735	15946	132
OJUM-01-40	40	.0400 - .1150	8000	6810	3800	56000	47660	26660	278
OJUM-01-50	50	.0500 - .1300	12500	10750	6125	87500	75265	42875	479

* according to iglus® testing method ➤ Page 29.57

DryLin® R Straight, Open, Low Clearance Linear Bearing - OJUM-21, mm



Special Properties

- Open, anodized aluminum adapter for supported shafts
- Dimensions equivalent to the standard for recirculating ball bearings
- Equipped with JUMO-20 liner made of iglide® J
- Recommended housing bore H7
- Secured the bearing with set screws (not included in the delivery)

OJUM-21 Bearings are used in:

- ▶ OQA-01, Page 29.53
- ▶ OTA-01, Page 29.54
- ▶ OGA-01, Page 29.55
- ▶ OGAS-01, Page 29.56

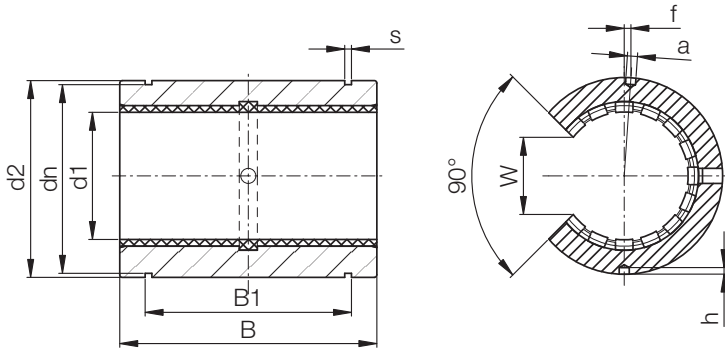

Dimensions (mm)

Part No.	d1	d2 h7	B h10	W	a +0.1	dn h10	B1 H10	s H10	f ±0.2	h -0.5
OJUM-21-10	10	19	29	7.3	0.0	17.5	21.6	1.30	0	1.2
OJUM-21-12	12	22	32	9.0	3.0	20.5	22.6	1.30	1.33 (7°)	1.2
OJUM-21-16	16	26	36	11.6	2.2	24.2	24.6	1.30	0	1.2
OJUM-21-20	20	32	45	12.0	2.2	29.6	31.2	1.60	0	1.2
OJUM-21-25	25	40	58	14.5	3.0	36.5	43.7	1.85	-1.5 (-4.3°)	1.5
OJUM-21-30	30	47	68	16.6	3.0	43.5	51.7	1.85	2 (4.9°)	2.0
OJUM-21-40	40	62	80	21.0	3.0	57.8	60.3	2.15	1.5 (2.8°)	2.0
OJUM-21-50	50	75	100	25.5	5.0	70.5	77.3	2.65	2.5 (3.8°)	2.0

Load Data

Part No.	Nominal Size	Tolerance* Bearing Inner Diameter	pmax. Dynamic Load P = 5 MPa (N)			pmax. Static Load P = 35 MPa (N)			Weight (g)
			0°	90°	180°	0°	90°	180°	
OJUM-21-10	10	.0150 - .0440	725	500	196	5075	3500	1370	11
OJUM-21-12	12	.0150 - .0440	960	635	240	6720	4445	1680	15
OJUM-21-16	16	.0150 - .0440	1440	990	396	10080	6943	2772	21
OJUM-21-20	20	.0150 - .0455	2250	1800	900	15750	12600	6300	42
OJUM-21-25	25	.0150 - .0455	3625	2953	1523	25375	20670	10658	70
OJUM-21-30	30	.0200 - .0550	5100	4250	2278	35700	29735	15946	132
OJUM-21-40	40	.0200 - .0575	8000	6810	3800	56000	47660	26660	278
OJUM-21-50	50	.0250 - .0650	12500	10750	6125	87500	75265	42875	479

* according to iglus® testing method ▶ Page 29.57

DryLin® R
Linear Guide Systems

PDF: www.igus.com/iglide-pdfs
CAD: www.igus.com/iglide-CAD
RoHS info: www.igus.com/RoHS

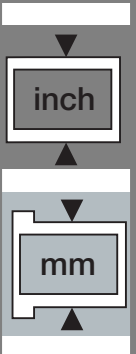



DryLin® R Self Aligning, Open Linear Bearing - OJUM-03, mm

DryLin® R
Linear Guide Systems

Telephone 1-800-521-2747
1-401-438-7270
Fax

Internet: <http://www.igus.com>
email: sales@igus.com
QuickSpec: <http://www.igus.com/iglide-quickspec>



Special Properties

- Open, aluminum adapter with
 - reduced outer diameter
 - spherical area on the outer diameter for automatic alignment compensation
 - O-rings for elastic seating
 - hard-anodized
- Dimensions correspond to the standard for recirculating ball bearings
- Equipped with JUMO liner made of iglide® J
- Recommended housing bore H7
- Attachment by mounting bolts (not included in delivery)

OJUM-03 Bearings are used in:
 ▶ OQA-01, Page 29.53
 ▶ OTA-01, Page 29.54
 ▶ OGA-01, Page 29.55
 ▶ OGAS-01, Page 29.56

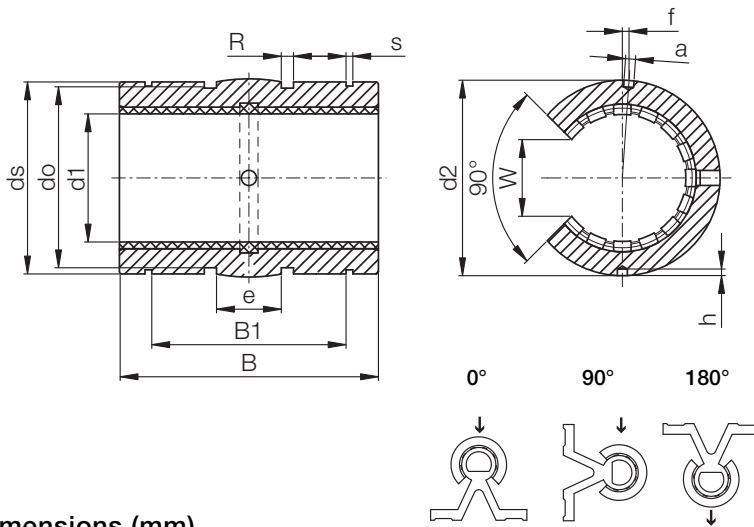

Housing Bore Dimensions

Nominal Size	METRIC	
	Min.	Max.
8	16.000	16.018
10	19.000	19.021
12	22.000	22.021
16	26.000	26.021
20	32.000	32.025
25	40.000	40.025
30	47.000	47.025
40	62.000	62.030
50	75.000	75.030

Dimensions (mm)

Part No.	d2 h7	ds h10	e	o +0.1	do h10	B1 H10	s H10	B h10	R	W	a +0.1	f ±0.2	h -0.5	a
OJUM-03-10	18.8	18.5	5.0	1.86	15.4	21.8	1.30	28.9	13.0	7.3	0.0	0	1.2	10
OJUM-03-12	21.8	21.5	6.0	1.86	18.4	22.8	1.30	31.9	18.0	9.0	3.0	1.33 (7°)	1.2	12
OJUM-03-16	25.8	25.5	8.0	2.86	20.4	24.9	1.30	35.9	32.0	11.6	2.2	0	1.2	16
OJUM-03-20	31.8	31.5	10.0	2.86	26.4	31.5	1.60	44.8	50.0	12.0	2.2	0	1.2	20
OJUM-03-25	39.8	39.0	12.5	2.86	34.4	44.1	1.85	57.8	39.0	14.5	3.0	-1.5 (-4.3°)	1.5	25
OJUM-03-30	46.7	46.0	15.0	2.86	41.4	52.1	1.85	67.8	57.0	16.6	3.0	2 (4.9°)	2	30
OJUM-03-40	61.7	61.0	20.0	2.86	56.4	60.9	2.15	79.8	100.0	21.0	3.0	1.5 (2.8°)	2	40
OJUM-03-50	74.7	74.0	25.0	2.86	69.4	78.0	2.65	99.8	157.0	25.5	5.0	2.5 (3.8°)	2	50

Load Data

Part No.	Nominal Size	Housing bore	Tolerance* Bearing Inner Diameter	pmax. Dynamic Load P = 5 MPa (N)			pmax. Static Load P = 35 MPa (N)			Weight (g)
				0°	90°	180°	0°	90°	180°	
				OJUM-03-10	10	19	.0300 - .0880	725	500	
OJUM-03-12	12	22	.0300 - .0880	960	635	240	6720	4445	1680	13
OJUM-03-16	16	26	.0300 - .0880	1440	990	396	10080	6943	2772	19
OJUM-03-20	20	32	.0300 - .0910	2250	1800	900	15750	12600	6300	38
OJUM-03-25	25	40	.0300 - .0910	3625	2953	1523	25375	20670	10658	63
OJUM-03-30	30	47	.0400 - .1100	5100	4250	2278	35700	29735	15946	119
OJUM-03-40	40	62	.0400 - .1150	8000	6810	3800	56000	47660	26660	250
OJUM-03-50	50	75	.0500 - .1300	12500	10750	6125	87500	75265	42875	431

* according to iglus® testing method ▶ Page 29.57

DryLin® R Self Aligning, Open, Low Clearance Linear Bearing - OJUM-23, mm



Special Properties

- Open, aluminum adapter with
 - reduced outer diameter
 - spherical area on the outer diameter for automatic alignment compensation
 - O-rings for elastic seating
 - hard-anodized
- Dimensions correspond to the standard for recirculating ball bearings
- Equipped with JUMO-20 liner made of iglide® J
- Recommended housing bore H7
- O-ring grease recommended for install
- Attachment by mounting bolts (not included in delivery)

OJUM-23 Bearings are used in:

- ▶ OQA-01, Page 29.55
- ▶ OTA-01, Page 29.56
- ▶ OGA-01, Page 29.57
- ▶ OGAS-01, Page 29.58

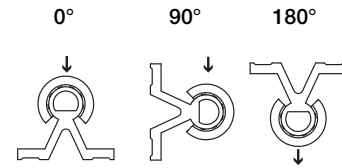
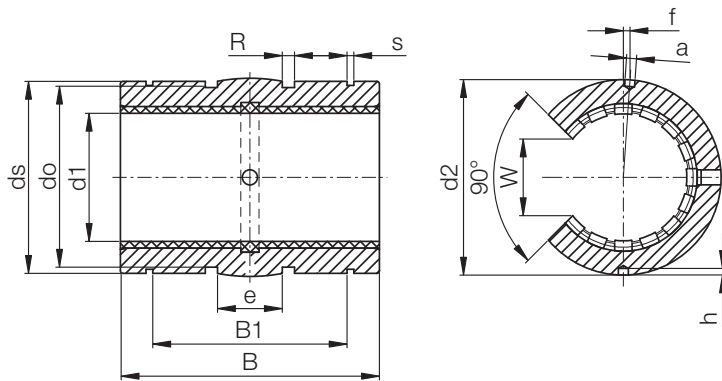

Dimensions (mm)

Part No.	d2 h7	ds h10	e	o +0.1	do h10	B1 H10	s H10	B h10	R	W	a +0.1	f ±0.2	h -0.5	a
OJUM-23-10	18.8	18.5	5.0	1.86	15.4	21.8	1.30	28.9	13.0	7.3	0.0	0	1.2	10
OJUM-23-12	21.8	21.5	6.0	1.86	18.4	22.8	1.30	31.9	18.0	9.0	3.0	1.33 (7°)	1.2	12
OJUM-23-16	25.8	25.5	8.0	2.86	20.4	24.9	1.30	35.9	32.0	11.6	2.2	0	1.2	16
OJUM-23-20	31.8	31.5	10.0	2.86	26.4	31.5	1.60	44.8	50.0	12.0	2.2	0	1.2	20
OJUM-23-25	39.8	39.0	12.5	2.86	34.4	44.1	1.85	57.8	39.0	14.5	3.0	-1.5 (-4.3°)	1.5	25
OJUM-23-30	46.7	46.0	15.0	2.86	41.4	52.1	1.85	67.8	57.0	16.6	3.0	2 (4.9°)	2	30
OJUM-23-40	61.7	61.0	20.0	2.86	56.4	60.9	2.15	79.8	100.0	21.0	3.0	1.5 (2.8°)	2	40
OJUM-23-50	74.7	74.0	25.0	2.86	69.4	78.0	2.65	99.8	157.0	25.5	5.0	2.5 (3.8°)	2	50

Load Data

Part No.	Nominal Size	Housing bore	Tolerance* Bearing Inner Diameter	pmax. Dynamic Load P = 5 MPa (N)			pmax. Static Load P = 35 MPa (N)			Weight (g)
				0°	90°	180°	0°	90°	180°	
				OJUM-23-10	10	19	.0150 - .0440	725	500	
OJUM-23-12	12	22	.0150 - .0440	960	635	240	6720	4445	1680	13
OJUM-23-16	16	26	.0150 - .0440	1440	990	396	10080	6943	2772	19
OJUM-23-20	20	32	.0150 - .0455	2250	1800	900	15750	12600	6300	38
OJUM-23-25	25	40	.0150 - .0455	3625	2953	1523	25375	20670	10658	63
OJUM-23-30	30	47	.0200 - .0550	5100	4250	2278	35700	29735	15946	119
OJUM-23-40	40	62	.0200 - .0575	8000	6810	3800	56000	47660	26660	250
OJUM-23-50	50	75	.0250 - .0650	12500	10750	6125	87500	75265	42875	431

* according to iglus® testing method ▶ Page 29.57

DryLin® R
Linear Guide Systems

PDF: www.igus.com/iglide-pdfs
CAD: www.igus.com/iglide-CAD
RoHS info: www.igus.com/RoHS

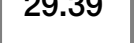
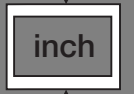



Special Properties

- Closed, anodized aluminum adapter
- Dimensions equivalent to the standard for recirculating ball bearings
- Equipped with JUM-02 liner made of iglide® J
- Secured by pressfit in a recommended housing bore
- Recommended housing bore H7 for steel housings or K7 for aluminum

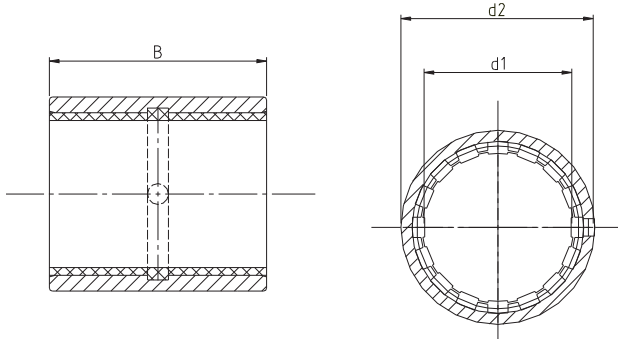

RJUM-02, Standard Clearance

Dimensions (mm)

Part No.	Nominal Size	Housing Bore i.d. h7	Tolerance** Bearing i.d.		pmax. Dynamic Load P = 5 MPa (N)	pmax. Static Load P = 35 MPa (N)	Weight (g)	d1	d2 k7	B h10
			Min.	Max.						
RJZM-02-08*	8	15	.0320	-.0700	650	4550	6	8	15	24
RJUM-02-10	10	17	.0300	-.0880	650	4550	8	10	17	26
RJUM-02-12	12	19	.0300	-.0880	840	5880	10	12	19	28
RJUM-02-16	16	24	.0300	-.0880	1200	8400	17	16	24	30
RJUM-02-20	20	28	.0300	-.0910	1500	10500	18	20	28	30
RJUM-02-25	25	35	.0300	-.0910	2500	17500	42	25	35	40
RJUM-02-30	30	40	.0400	-.1100	3750	26250	56	30	40	50
RJUM-02-40	40	52	.0400	-.1150	6000	42000	113	40	52	60
RJUM-02-50	50	60	.0500	-.1300	8750	61250	147	50	60	70

RJUM-22, Low Clearance

Dimensions (mm)

Part No.	Nominal Size	Housing Bore i.d.	Tolerance** Bearing i.d.		pmax. Dynamic Load P = 5 MPa (N)	pmax. Static Load P = 35 MPa (N)	Weight (g)	d1	d2 k7	B h10
			Min.	Max.						
RJZM-02-08*	8	15	.0160	-.0350	215	1510	6	8	15	24
RJUM-22-10	10	17	.0150	-.0440	146	1022	8	10	17	26
RJUM-22-12	12	19	.0150	-.0440	188	1321	10	12	19	28
RJUM-22-16	16	24	.0150	-.0440	269	1888	17	16	24	30
RJUM-22-20	20	28	.0150	-.0455	337	2360	18	20	28	30
RJUM-22-25	25	35	.0150	-.0455	562	3934	42	25	35	40
RJUM-22-30	30	40	.0200	-.0550	843	5901	56	30	40	50
RJUM-22-40	40	52	.0200	-.0575	1348	9441	113	40	52	60
RJUM-22-50	50	60	.0250	-.0650	1967	13769	147	50	60	70

DryLin® R Closed Pillow Block, Short Design Linear Bearing RJUM-05, mm

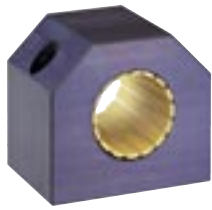

Special Properties

- Closed, anodized aluminum housing, short design
- Contains JUM-02-XX liner

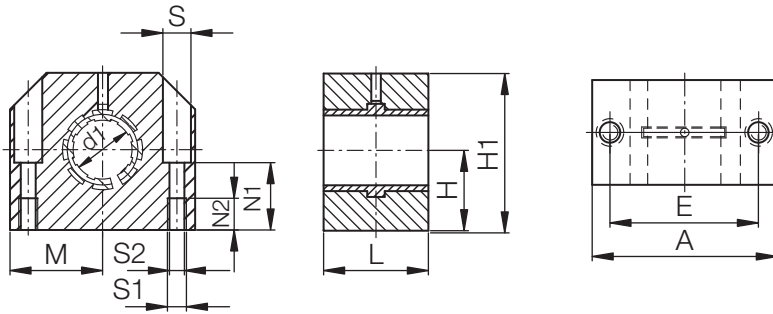

Dimensions (mm)

Part No.	d1	H +0.01 -0.014	H1	A	M	E ±0.15	S	S1	S2	N1	N2	L
RJUM- <input type="text"/> -10	10	16	33	40	20.0	29	8.0	M 5	4.3	16	11	26
RJUM- <input type="text"/> -12	12	17	33	40	20.0	29	8.0	M 5	4.3	16	11	28
RJUM- <input type="text"/> -16	16	19	38	45	22.5	34	8.0	M 5	4.3	18	11	30
RJUM- <input type="text"/> -20	20	23	45	53	26.5	40	9.5	M 6	5.3	22	13	30
RJUM- <input type="text"/> -25	25	27	54	62	31.0	48	11.0	M 8	6.6	26	18	40
RJUM- <input type="text"/> -30	30	30	60	67	33.5	53	11.0	M 8	6.6	29	18	50
RJUM- <input type="text"/> -40	40	39	76	87	43.5	69	15.0	M10	8.4	38	22	60
RJUM- <input type="text"/> -50	50	47	92	103	51.5	82	18.0	M12	10.5	46	26	70

Supplement the part number with one of the following choices.
Example: RJUM--10 for a standard version

For Standard version use (See page 27.24)

For Low Clearance version use (See page 27.24)

Load Data

Part No.	Nominal Size	Tolerance* Bearing Inner Diameter	pmax. Dynamic Load P = 5 MPa (N)	pmax. Static Load P = 35 MPa (N)	Weight (g)
RJUM- <input type="text"/> -10	10	.0300 - .0880	650	4550	71
RJUM- <input type="text"/> -12	12	.0300 - .0880	840	5880	78
RJUM- <input type="text"/> -16	16	.0300 - .0880	1200	8400	106
RJUM- <input type="text"/> -20	20	.0300 - .0910	1500	10500	132
RJUM- <input type="text"/> -25	25	.0300 - .0910	2500	17500	253
RJUM- <input type="text"/> -30	30	.0400 - .1100	3750	26250	374
RJUM- <input type="text"/> -40	40	.0400 - .1150	6000	42000	713
RJUM- <input type="text"/> -50	50	.0500 - .1300	8750	61250	1.168

* according to iglus® testing method ▶ Page 29.57

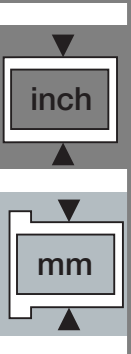



DryLin® R Adjustable Pillow Block, Short Design Linear Bearing RJUME-05, mm

DryLin® R
Linear Guide Systems

Telephone 1-800-521-2747
Fax 1-401-438-7270

Internet: <http://www.igus.com>
email: sales@igus.com
QuickSpec: <http://www.igus.com/iglide-quickspec>

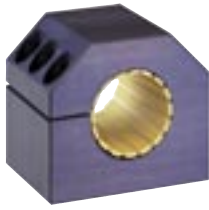

Special Properties

- Adjustable, anodized aluminum housing, short design
- Contains JUM-02-XX liner
- With adjustable clearance for shaft dimensions 12 to 40 mm

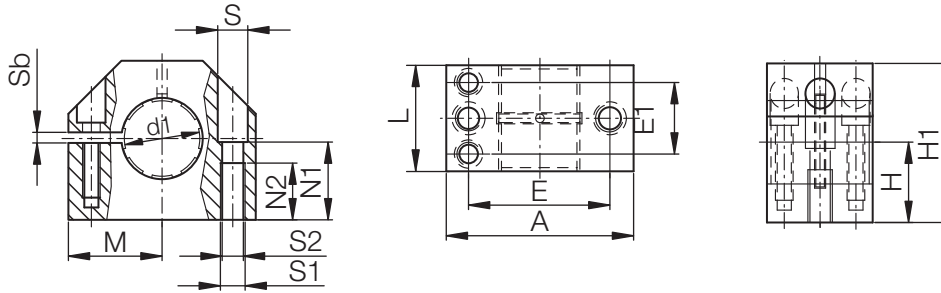

Dimensions (mm)

Part No.	d1	H +0.01 -0.014	H1	A	M	E ±0.15	E1 ±0.15	S	S1	S2	Sb	N1	N2	L
RJUME- <input type="text"/> -12	12	17	33	40	20.0	29	18.0	8.0	4.3	M 5	2	16	11	28
RJUME- <input type="text"/> -16	16	19	38	45	22.5	34	19.0	8.0	4.3	M 5	2	18	11	30
RJUME- <input type="text"/> -20	20	23	45	53	26.5	40	20.0	9.5	5.3	M 6	2	22	13	30
RJUME- <input type="text"/> -25	25	27	54	62	31.0	48	25.5	11.0	6.6	M 8	2	26	18	40
RJUME- <input type="text"/> -30	30	30	60	67	33.5	53	30.5	11.0	6.6	M 8	2	29	18	50
RJUME- <input type="text"/> -40	40	39	76	87	43.5	69	36.0	15.0	8.4	M10	2	38	22	60

Supplement the part number with one of the following choices.

Example: RJUME--12 for a standard version

For Standard version use (See page 27.24)

For Low Clearance version use (See page 27.24)

Load Data

Part No.	Nominal Size	Tolerance Bearing Inner Diameter	pmax. Dynamic Load P = 5 MPa (N)	pmax. Static Load P = 35 MPa (N)	Weight (g)
RJUME- <input type="text"/> -12	12	adjustable	840	5880	78
RJUME- <input type="text"/> -16	16	adjustable	1200	8400	106
RJUME- <input type="text"/> -20	20	adjustable	1500	10500	132
RJUME- <input type="text"/> -25	25	adjustable	2500	17500	253
RJUME- <input type="text"/> -30	30	adjustable	3750	26250	374
RJUME- <input type="text"/> -40	40	adjustable	6000	42000	713

DryLin® R Closed Pillow Block, Long Design Linear Bearing RJUM-06, mm



DryLin® R
Linear Guide Systems

PDF: www.igus.com/iglide-pdfs
CAD: www.igus.com/iglide-CAD
RoHS info: www.igus.com/RoHS

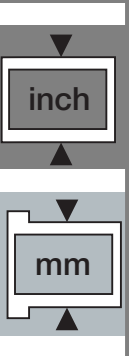

Special Properties

- Closed, anodized aluminum housing, long design
- Contains JUM-01-XX liner

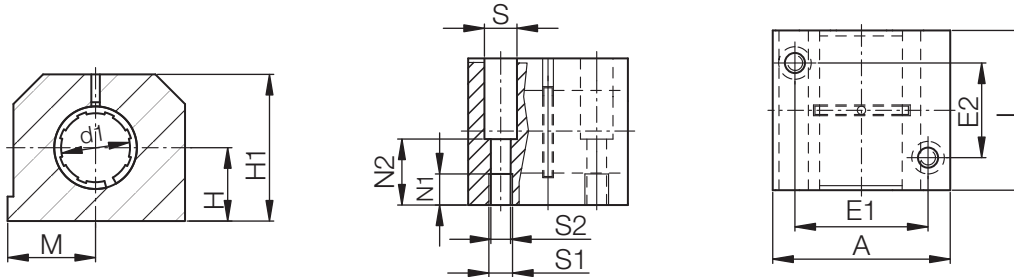

Dimensions (mm)

Part No.	d1	H +0.01 -0.014	H1	A	M	E1 ±0.15	E2 ±0.15	S	S1	S2	N1	N2	L
RJUM- <input type="text"/> -12	12	18	35	43	21.5	32	23	8.0	M 5	4.3	16.5	11	39
RJUM- <input type="text"/> -16	16	22	42	53	26.5	40	26	10.0	M 6	5.3	21.0	13	43
RJUM- <input type="text"/> -20	20	25	50	60	30.0	45	32	11.0	M 8	6.6	24.0	18	54
RJUM- <input type="text"/> -25	25	30	60	78	39.0	60	40	15.0	M10	8.4	29.0	22	67
RJUM- <input type="text"/> -30	30	35	70	87	43.5	68	45	15.0	M10	8.4	34.0	22	79
RJUM- <input type="text"/> -40	40	45	90	108	54.0	86	58	18.0	M12	10.5	44.0	26	91
RJUM- <input type="text"/> -50	50	50	105	132	66.0	108	50	20.0	M16	13.5	49.0	34	113

Supplement the part number with one of the following choices.
Example: RJUM-06-12 for a standard version

For Standard version use 06 (See page 27.24)

For Low Clearance version use 36 (See page 27.24)

Load Data

Part No.	Nominal Size	Tolerance* Bearing Inner Diameter	pmax. Dynamic Load P = 5 MPa (N)	pmax. Static Load P = 35 MPa (N)	Weight (kg)
RJUM- <input type="text"/> XX <input type="text"/> -12	12	.0300 - .0880	960	6720	0.121
RJUM- <input type="text"/> XX <input type="text"/> -16	16	.0300 - .0880	1440	10080	0.211
RJUM- <input type="text"/> XX <input type="text"/> -20	20	.0300 - .0910	2250	15750	0.323
RJUM- <input type="text"/> XX <input type="text"/> -25	25	.0300 - .0910	3625	25375	0.651
RJUM- <input type="text"/> XX <input type="text"/> -30	30	.0400 - .1100	5100	35700	1.050
RJUM- <input type="text"/> XX <input type="text"/> -40	40	.0400 - .1150	8000	56000	1.820
RJUM- <input type="text"/> XX <input type="text"/> -50	50	.0500 - .1300	12500	87500	3.250

* according to igus® testing method ➤ Page 29.57



DryLin® R Floating Pillow Block RJUM-06 LL, mm

DryLin® R
Linear Guide Systems

Telephone 1-800-521-2747
Fax 1-401-438-7270

Internet: <http://www.igus.com>
email: sales@igus.com
QuickSpec: <http://www.igus.com/iglide-quickspec>



Special Properties

- For extreme misalignments
- Closed, anodized aluminum housing, long design
- Contains JUM-01-XX liner
- Compensation of angle errors +/- 3.5°
- Same properties as standard pillow block
- Compensation of parallelism errors up to 6mm
- Compensates for angular errors and bending of the shaft

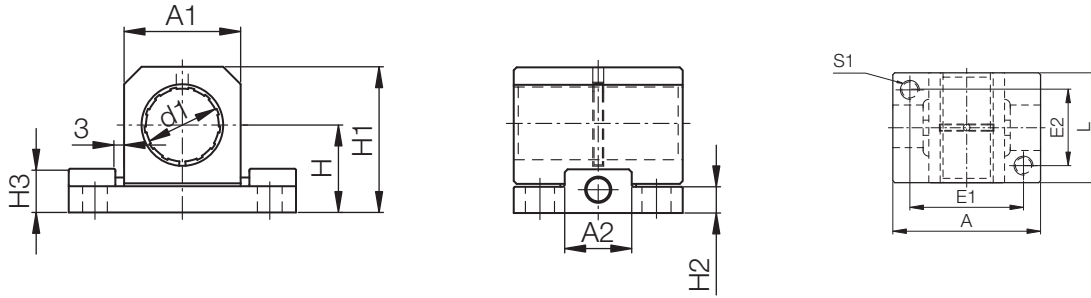

Dimensions (mm)

Part No.	d1	H	H1	A	E1 ±0.15	E2 ±0.15	S1	L	A1	A2	H2	H3
RJUM- <input type="text"/> -12 LL	12	18	28	43	32	23	M 5	39	20	13	6	11
RJUM- <input type="text"/> -16 LL	16	22	35	53	40	26	M 6	43	26	15	7	11
RJUM- <input type="text"/> -20 LL	20	25	41	60	45	32	M 8	54	32	19	7	12.5
RJUM- <input type="text"/> -25 LL	25	30	50	78	60	40	M 10	67	40	23	9	15
RJUM- <input type="text"/> -30 LL	30	35	59	87	68	45	M 10	79	48	28	10	15

Supplement the part number with one of the following choices.
Example: RJUM--12 LL for a standard floating version

For Standard floating version use (See page 27.24)

For Low Clearance floating version use (See page 27.24)

Load Data

Part No.	Nominal Size	Tolerance* Bearing Inner Diameter	pmax. (N)	Weight (kg)
RJUM- <input type="text"/> -12 LL	12	.0300 - .0880	560	0.050
RJUM- <input type="text"/> -16 LL	16	.0300 - .0880	920	0.080
RJUM- <input type="text"/> -20 LL	20	.0300 - .0910	2100	0.130
RJUM- <input type="text"/> -25 LL	25	.0300 - .0910	3550	0.280
RJUM- <input type="text"/> -30 LL	30	.0400 - .1100	5300	0.430

* according to iglus® testing method ▶ Page 29.57

DryLin® R Split Pillow Block TJUM-05, mm

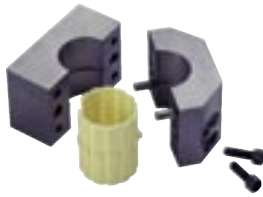

Special Properties

- Split, anodized aluminum housing, bolted
- Contains JUM-02-XX liner
- Replacement of the liner without disassembling the shaft

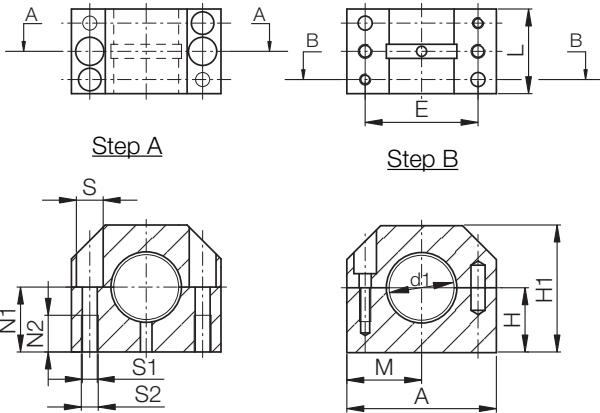

Dimensions (mm)

Part No.	d1	H ±0.02	H1	A	M	E ±0.15	S	S1	S2	N1	N2	L
TJUM- <input type="text"/> -16	16	19	38	45	22.5	34	8.0	M 5	4.3	18	11	30
TJUM- <input type="text"/> -20	20	23	45	53	26.5	40	9.5	M 6	5.3	22	13	30
TJUM- <input type="text"/> -25	25	27	54	62	31.0	48	11.0	M 8	6.6	26	18	40
TJUM- <input type="text"/> -30	30	30	60	67	33.5	53	11.0	M 8	6.6	29	18	50
TJUM- <input type="text"/> -40	40	39	76	87	43.5	69	15.0	M10	8.4	38	22	60

Supplement the part number with one of the following choices.
Example: TJUM-05-16 for a standard version

For Standard version use 05 (See page 27.24)

For Low Clearance version use 35 (See page 27.24)

Load Data

Part No.	Nominal Size	Tolerance Bearing Inner Diameter	pmax. Dynamic Load P = 5 MPa (N)	pmax. Static Load P = 35 MPa (N)	Weight (g)
TJUM- <input type="text"/> XX-16	16	.0300-.1200	1200	8400	105
TJUM- <input type="text"/> XX-20	20	.0300-.1200	1500	10500	137
TJUM- <input type="text"/> XX-25	25	.0300-.1200	2500	17500	253
TJUM- <input type="text"/> XX-30	30	.0400-.1350	3750	26250	377
TJUM- <input type="text"/> XX-40	40	.0400-.1350	6000	42000	720

* according to iglus® testing method ► Page 29.57

DryLin® R
Linear Guide Systems

PDF: www.igus.com/iglide-pdfs
CAD: www.igus.com/iglide-CAD
RoHS info: www.igus.com/RoHS

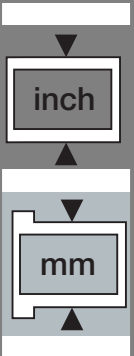



DryLin® R Open Pillow Block, Long Design Linear Bearing OJUM-06, mm

DryLin® R
Linear Guide Systems

Telephone 1-800-521-2747
Fax 1-401-438-7270

Internet: <http://www.igus.com>
email: sales@igus.com
QuickSpec: <http://www.igus.com/iglide-quickspec>



Special Properties

- Open, anodized aluminum housing, long design
- Contains JUMO-01-XX liner

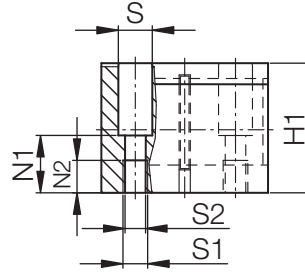
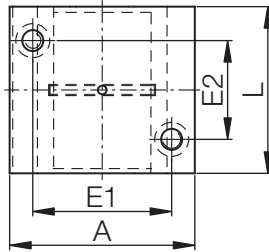
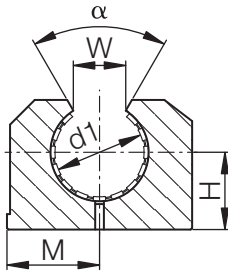

Dimensions (mm)

Part No.	d1	H +0.01	H1	A	M	E ±0.15	E2 ±0.15	S	S1	S2	N1	N2	W	α (°)	L
OJUM-□-12	12	18	28	43	21.5	32	23	8.0	M 5	4.3	16.5	11	10.2	78	39
OJUM-□-16	16	22	35	53	26.5	40	26	10.0	M 6	5.3	21.0	13	11.6	78	43
OJUM-□-20	20	25	42	60	30.0	45	32	11.0	M 8	6.6	24.0	18	12.0	60	54
OJUM-□-25	25	30	51	78	39.0	60	40	15.0	M10	8.4	29.0	22	14.5	60	67
OJUM-□-30	30	35	60	87	43.5	68	45	15.0	M10	8.4	34.0	22	16.6	57	79
OJUM-□-40	40	45	77	108	54.0	86	58	18.0	M12	10.5	44.0	26	21.0	56	91
OJUM-□-50	50	50	88	132	66.0	108	50	20.0	M16	13.5	49.0	34	25.5	54	113

Supplement the part number with one of the following choices.
Example: OJUM-□06-12 for a standard version

For Standard version use □06 (See page 27.25)

For Low Clearance version use □36 (See page 27.25)

Load Data

Part No.	Nominal Size	Tolerance* Bearing Inner Diameter	pmax. Dynamic Load P = 5 MPa (N)			pmax. Static Load P = 35 MPa (N)			Weight (kg)
			0°	90°	180°	0°	90°	180°	
OJUM-□XX-12	12	.0300 - .0880	960	635	240	6720	4445	1680	0.095
OJUM-□XX-16	16	.0300 - .0880	1440	990	396	10080	6943	2772	0.158
OJUM-□XX-20	20	.0300 - .0910	2250	1800	900	15750	12600	6300	0.266
OJUM-□XX-25	25	.0300 - .0910	3625	2953	1523	25375	20670	10658	0.530
OJUM-□XX-30	30	.0400 - .1100	5100	4250	2278	35700	29735	15946	0.818
OJUM-□XX-40	40	.0400 - .1150	8000	6810	3800	56000	47660	26660	1.485
OJUM-□XX-50	50	.0500 - .1300	12500	10750	6125	87500	75265	42875	2.750

* according to iglus® testing method ▶ Page 29.57

DryLin® R Adjustable Pillow Block, Long Design Linear Bearing OJUME-06, mm



Special Properties

- Open, anodized aluminum housing, standard
- Contains JUMO-01-XX liner made of iglide® J is fitted as standard
- Adjustable clearance: with 2 set screws (DIN 913) one side of the block can be adjusted
- Recommended tolerance for the shaft: h6-h10 (see iglus® supported shafts Page 29.61)
- Also available with the following liners:
TUMO-01: for high temperatures up to 356°F, material iglide® T500 - Example: OTUM-06-16
JUMO-11: with reduced maximum clearance, material iglide® J - Example: OJUM-20-16

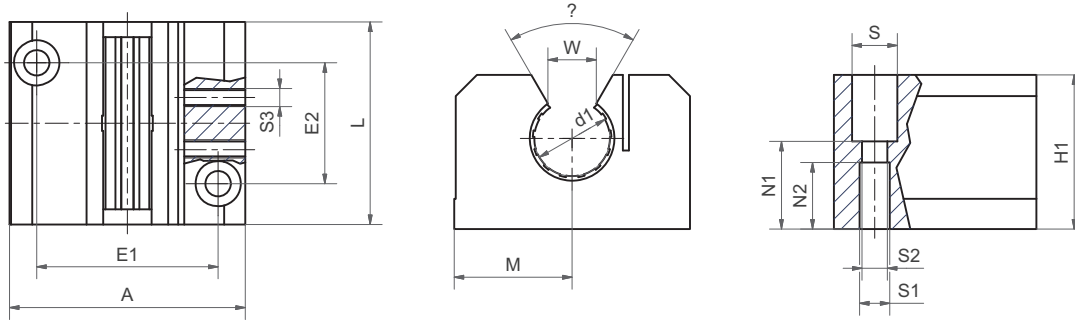

Dimensions (mm)

Part No.	d1	H +0.01	H1	A	M	E ±0.15	E2 ±0.15	S	S1	S2	N1	N2	W	α (°)	L
OJUME- <input type="text"/> -12	12	18	28	43	21.5	32	23	8.0	M 5	4.3	16.5	11	10.2	78	39
OJUME- <input type="text"/> -16	16	22	35	53	26.5	40	26	10.0	M 6	5.3	21.0	13	11.6	78	43
OJUME- <input type="text"/> -20	20	25	42	60	30.0	45	32	11.0	M 8	6.6	24.0	18	12.0	60	54
OJUME- <input type="text"/> -25	25	30	51	78	39.0	60	40	15.0	M10	8.4	29.0	22	14.5	60	67
OJUME- <input type="text"/> -30	30	35	60	87	43.5	68	45	15.0	M10	8.4	34.0	22	16.6	57	79
OJUME- <input type="text"/> -40	40	45	77	108	54.0	86	58	18.0	M12	10.5	44.0	26	21.0	56	91
OJUME- <input type="text"/> -50	50	50	88	132	66.0	108	50	20.0	M16	13.5	49.0	34	25.5	54	113

Supplement the part number with one of the following choices.
Example: OJUME--12 for a standard version

For Standard version use (See page 27.25)

For Low Clearance version use (See page 27.25)

Load Data

Part No.	Nominal Size	Tolerance* Bearing Inner Diameter	pmax. Dynamic Load P = 5 MPa (N)			pmax. Static Load P = 35 MPa (N)			Weight (kg)
			0°	90°	180°	0°	90°	180°	
OJUME- <input type="text"/> -12	12	.0300 - .0880	960	635	240	6720	4445	1680	0.095
OJUME- <input type="text"/> -16	16	.0300 - .0880	1440	990	396	10080	6943	2772	0.158
OJUME- <input type="text"/> -20	20	.0300 - .0910	2250	1800	900	15750	12600	6300	0.266
OJUME- <input type="text"/> -25	25	.0300 - .0910	3625	2953	1523	25375	20670	10658	0.530
OJUME- <input type="text"/> -30	30	.0400 - .1100	5100	4250	2278	35700	29735	15946	0.818
OJUME- <input type="text"/> -40	40	.0400 - .1150	8000	6810	3800	56000	47660	26660	1.485
OJUME- <input type="text"/> -50	50	.0500 - .1300	12500	10750	6125	87500	75265	42875	2.750

* according to iglus® testing method ▶ Page 29.57

DryLin® R
Linear Guide Systems

PDF: www.igus.com/iglide-pdfs
CAD: www.igus.com/iglide-CAD
RoHS info: www.igus.com/RoHS

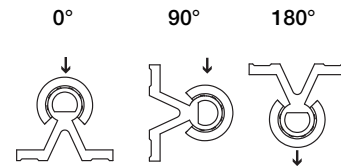
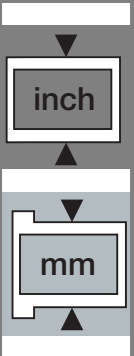



DryLin® R Open Floating Pillow Block, Long Design Linear Bearing OJUM-06 LL, mm

DryLin® R
Linear Guide Systems

Telephone 1-800-521-2747
Fax 1-401-438-7270

Internet: <http://www.igus.com>
email: sales@igus.com
QuickSpec: <http://www.igus.com/iglide-quickspec>



Special Properties

- For extreme misalignments
- Closed, anodized aluminum housing, long design
- Contains JUM-01-XX liner
- Compensation of angle errors +/- 3.5°
- Same properties as standard pillow block
- Compensation of parallelism errors up to 6mm
- Compensates for angular errors and bending of the shaft

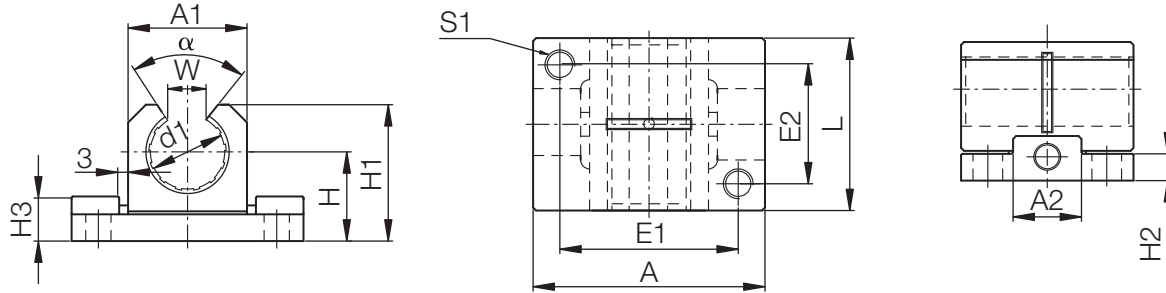

Dimensions (mm)

Part No.	d1	H	H1	A	E1 ±0.15	E2 ±0.15	S1	L	A1	A2	H2	H3	W	α [°]
OJUM- <input type="text"/> -12 LL	12	18	24.5	43	32	23	M 5	39	20	13	6	11	10.2	90
OJUM- <input type="text"/> -16 LL	16	22	30.5	53	40	26	M 6	43	26	15	7	11	11.6	90
OJUM- <input type="text"/> -20 LL	20	25	37	60	45	32	M 8	54	32	19	7	12.5	12	60
OJUM- <input type="text"/> -25 LL	25	30	44	78	60	40	M10	67	40	23	9	15	14.5	60
OJUM- <input type="text"/> -30 LL	30	35	52.5	87	68	45	M10	79	48	28	10	15	16.8	60

Supplement the part number with one of the following choices.
Example: OJUM--10 for a standard version

For Standard version use (See page 27.25)

For Low Clearance version use (See page 27.25)

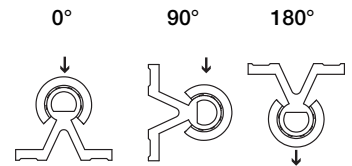

Load Data

Part No.	Nominal Size	Tolerance* Bearing Inner Diameter	pmax. (N) at 0°	pmax. (N) at 90°	pmax. (N) at 180°	Weight [kg]
OJUM- <input type="text"/> -12 LL	12	.0300 - .0880	560	NA	240	0.040
OJUM- <input type="text"/> -16 LL	16	.0300 - .0880	920	NA	400	0.070
OJUM- <input type="text"/> -20 LL	20	.0300 - .0910	2100	NA	900	0.115
OJUM- <input type="text"/> -25 LL	25	.0300 - .0910	3550	NA	1520	0.240
OJUM- <input type="text"/> -30 LL	30	.0400 - .1100	5300	NA	2280	0.370

* according to iglus® testing method ▶ Page 29.57

DryLin® R Flange Pillow Block, Round Design FJUM-01, mm



Special Properties

- Flange housing made of anodized aluminum, round flange
- Contains JUM-01-XX liner

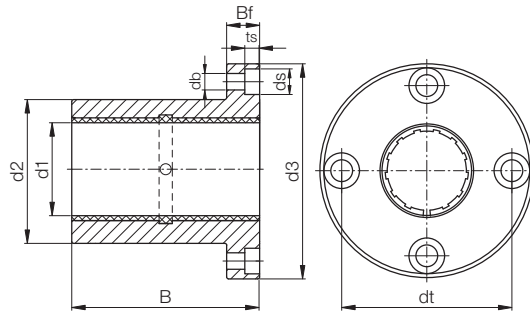

Dimensions (mm)

Part No.	d1	d2 h7	dt	d3	B	Bf	ts	db	ds
FJZM- <input type="text"/> -08*	8	16	24	32	25	8	3.1	3.5	6.0
FJUM- <input type="text"/> -10	10	19	29	39	29	9	4.1	4.5	7.5
FJUM- <input type="text"/> -12	12	22	32	42	32	9	4.1	4.5	7.5
FJUM- <input type="text"/> -16	16	26	36	46	36	9	4.1	4.5	7.5
FJUM- <input type="text"/> -20	20	32	43	54	45	11	5.1	5.5	9.0
FJUM- <input type="text"/> -25	25	40	51	62	58	11	5.1	5.5	9.0
FJUM- <input type="text"/> -30	30	47	62	76	68	14	6.1	6.6	11.0
FJUM- <input type="text"/> -40	40	62	80	98	80	18	8.1	9.0	14.0
FJUM- <input type="text"/> -50	50	75	94	112	100	18	8.1	9.0	15.0

Supplement the part number with one of the following choices.
Example: FJUM-01-10 for a standard version

For Standard version use 01 (See page 27.24)

For Low Clearance version use 31 (See page 27.24)

Load Data

Part No.	Nominal Size	Tolerance** Bearing Inner Diameter	pmax. Dynamic Load	pmax. Static Load	Weight (g)
			P = 5 MPa (N)	P = 35 MPa (N)	
FJZM- <input type="text"/> XX-08*	8	.0320 - .0700	960	6720	20
FJUM- <input type="text"/> XX-10	10	.0300 - .0880	725	5075	32
FJUM- <input type="text"/> XX-12	12	.0300 - .0880	960	6720	42
FJUM- <input type="text"/> XX-16	16	.0300 - .0880	1440	10080	51
FJUM- <input type="text"/> XX-20	20	.0300 - .0910	2250	15750	88
FJUM- <input type="text"/> XX-25	25	.0300 - .0910	3625	25375	152
FJUM- <input type="text"/> XX-30	30	.0400 - .1100	5100	35700	266
FJUM- <input type="text"/> XX-40	40	.0400 - .1150	8000	56000	552
FJUM- <input type="text"/> XX-50	50	.0500 - .1300	12500	87500	853

* Nominal widths under 10mm are delivered with pressfit sleeve bearings

* according to iglus® testing method ➤ Page 29.57

DryLin® R
Linear Guide Systems

PDF: www.igus.com/iglide-pdfs
CAD: www.igus.com/iglide-CAD
RoHS info: www.igus.com/RoHS

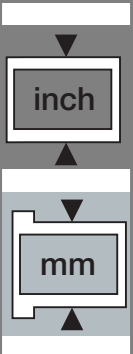



DryLin® R Flange Pillow Block, Square Design FJUM-02, mm

DryLin® R
Linear Guide Systems

Telephone 1-800-521-2747
Fax 1-401-438-7270

Internet: <http://www.igus.com>
email: sales@igus.com
QuickSpec: <http://www.igus.com/iglide-quickspec>



Special Properties

- Flange housing made of anodized aluminum, square flange
- Contains JUM-01-XX liner

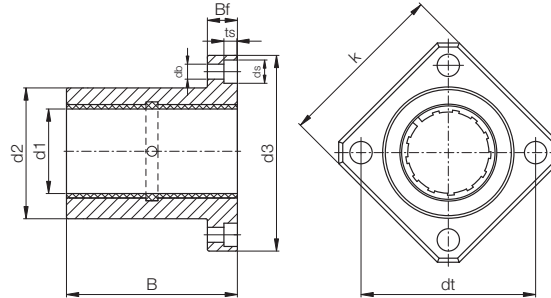

Dimensions (mm)

Part No.	d1	d2 h7	d3	dt	k	B	Bf	ts	db	ds
FJZM-□-08*	8	16	32	24	25	25	8	3.1	3.5	6.0
FJUM-□-10	10	19	39	29	30	29	9	4.1	4.5	7.5
FJUM-□-12	12	22	42	32	32	32	9	4.1	4.5	7.5
FJUM-□-16	16	26	46	36	35	36	9	4.1	4.5	7.5
FJUM-□-20	20	32	54	43	42	45	11	5.1	5.5	9.0
FJUM-□-25	25	40	62	51	50	58	11	5.1	5.5	9.0
FJUM-□-30	30	47	76	62	60	68	14	6.1	6.6	11.0
FJUM-□-40	40	62	98	80	75	80	18	8.1	9.0	15.0
FJUM-□-50	50	75	112	94	88	100	18	8.1	9.0	14.0

Supplement the part number with one of the following choices.
Example: FJUM-□02□10 for a standard version

For Standard version use □02□ (See page 27.24)

For Low Clearance version use □32□ (See page 27.24)

Load Data

Part No.	Nominal Size	Tolerance** Bearing Inner Diameter	pmax. Dynamic Load P = 5 MPa	pmax. Static Load P = 35 MPa	Weight (g)
FJZM-□XX□-08*	8	.0320 - .0700	960	6720	17
FJUM-□XX□-10	10	.0300 - .0880	725	5075	25
FJUM-□XX□-12	12	.0300 - .0880	960	6720	32
FJUM-□XX□-16	16	.0300 - .0880	1440	10080	41
FJUM-□XX□-20	20	.0300 - .0910	2250	15750	73
FJUM-□XX□-25	25	.0300 - .0910	3625	25375	135
FJUM-□XX□-30	30	.0300 - .1100	5100	35700	228
FJUM-□XX□-40	40	.0300 - .1150	8000	56000	454
FJUM-□XX□-50	50	.0300 - .1300	12500	87500	735

* Nominal widths under 10mm are delivered with pressfit sleeve bearings

* according to igus® testing method ▶ Page 29.57

DryLin® R Twin Flange Pillow Block Round Design FJUMT-01, mm



Special Properties

- Flange housing made of anodized aluminum, round flange
- Contains 2 of the JUM-02-XX liners

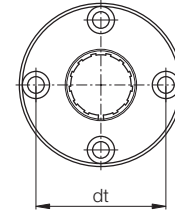
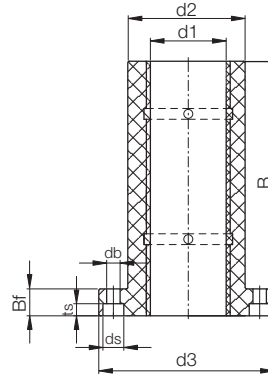

Dimensions (mm)

Part No.	d1	d2 h7	d3	dt	k	B	Bf	ts	db	ds
FJUMT-01-08*	8	16	32	24	25	45	8	3.1	3.5	6.0
FJUMT-01-10	10	19	39	29	30	52	9	4.1	4.5	7.5
FJUMT-01-12	12	22	42	32	32	57	9	4.1	4.5	7.5
FJUMT-01-16	16	26	46	36	35	70	9	4.1	4.5	7.5
FJUMT-01-20	20	32	54	43	42	80	11	5.1	5.5	9.0
FJUMT-01-25	25	40	62	51	50	112	11	5.1	5.5	9.0
FJUMT-01-30	30	47	76	62	60	123	14	6.1	6.6	11.0
FJUMT-01-40	40	62	98	80	75	151	18	8.1	9.0	14.0
FJUMT-01-50	50	75	112	94	88	192	18	8.1	9.0	14.0

Part No.	Nominal Size	Tolerance** Bearing Inner Diameter	pmax. Dynamic Load	pmax. Static Load
			P = 5 MPa (N)	P = 35 MPa (N)
FJZMT-01-08*	8	.0320 - .0700	1913	13430
FJUMT-01-10	10	.0300 - .0880	1450	10150
FJUMT-01-12	12	.0300 - .0880	1913	13430
FJUMT-01-16	16	.0300 - .0880	2874	20160
FJUMT-01-20	20	.0300 - .0910	4493	31490
FJUMT-01-25	25	.0300 - .0910	7251	50750
FJUMT-01-30	30	.0400 - .1100	10200	71390
FJUMT-01-40	40	.0400 - .1150	16000	112000
FJUMT-01-50	50	.0500 - .1300	25000	175000

For a Low Clearance version use part number FJUMT-31-XX

Comparison of Flange Length and Bearing Surface of FJUM and FJUMT

Part No.	Nominal Diameter (mm)	Flange Length (mm)			Effective Surface Area (mm ²)		
		FJUM-01-..	FJUMT-01-..	Difference (%)	FJUM-01-..	FJUMT-01-..	Difference (%)
FJZMT-01-08	08*	25	45	+80	192	256	+33
FJUMT-01-10	10	29	52	+80	145	250	+72
FJUMT-01-12	12	32	57	+78	186	324	+74
FJUMT-01-16	16	36	70	+94	280	464	+66
FJUMT-01-20	20	45	80	+78	440	580	+32
FJUMT-01-25	25	58	112	+93	712	975	+37
FJUMT-01-30	30	68	123	+81	1005	1470	+46
FJUMT-01-40	40	80	151	+89	1580	2360	+49
FJUMT-01-50	50	100	192	+92	2475	3450	+39

* FJZMT-01-08 are equipped with 2 pieces JSM-0810-16

* Nominal widths under 10mm are delivered with pressfit sleeve bearings

PDF: www.igus.com/iglide-pdfs
CAD: www.igus.com/iglide-CAD
RoHS info: www.igus.com/RoHS

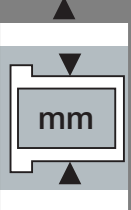
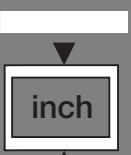



DryLin® R Twin Flange Pillow Block Square Design FJUMT-02, mm

DryLin® R
Linear Guide Systems



Special Properties

- Flange housing made of anodized aluminum, square flange
- Contains 2 of the JUM-02-XX liners

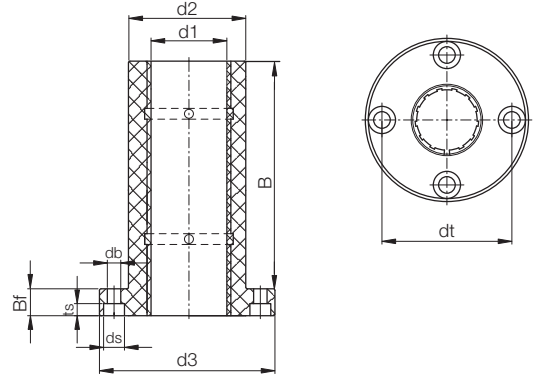

Dimensions (mm)

Part No.	d1	d2 h7	d3	dt	k	B	Bf	ts	db	ds
FJUMT-02-08*	8	16	32	24	25	45	8	3.1	3.5	6.0
FJUMT-02-10	10	19	39	29	30	52	9	4.1	4.5	7.5
FJUMT-02-12	12	22	42	32	32	57	9	4.1	4.5	7.5
FJUMT-02-16	16	26	46	36	35	70	9	4.1	4.5	7.5
FJUMT-02-20	20	32	54	43	42	80	11	5.1	5.5	9.0
FJUMT-02-25	25	40	62	51	50	112	11	5.1	5.5	9.0
FJUMT-02-30	30	47	76	62	60	123	14	6.1	6.6	11.0
FJUMT-02-40	40	62	98	80	75	151	18	8.1	9.0	14.0
FJUMT-02-50	50	75	112	94	88	192	18	8.1	9.0	14.0

Load Data

Part No.	Nominal Size	Tolerance** Bearing Inner Diameter	pmax. Dynamic Load	pmax. Static Load
			P = 5 MPa (N)	P = 35 MPa (N)
FJZMT-02-08*	8	.0320 - .0700	1913	13430
FJUMT-02-10	10	.0300 - .0880	1450	10150
FJUMT-02-12	12	.0300 - .0880	1913	13430
FJUMT-02-16	16	.0300 - .0880	2874	20160
FJUMT-02-20	20	.0300 - .0910	4493	31490
FJUMT-02-25	25	.0300 - .0910	7251	50750
FJUMT-02-30	30	.0400 - .1100	10200	71390
FJUMT-02-40	40	.0400 - .1150	16000	112000
FJUMT-02-50	50	.0500 - .1300	25000	175000

For a Low Clearance version use part number FJUMT-32-XX

Comparison of Flange Length and Bearing Surface of FJUM and FJUMT

Part No.	Nominal Diameter (mm)	Flange Length (mm)			Effective Surface Area (mm ²)		
		FJUM-02-...	FJUMT-02-...	Difference (%)	FJUM-02-...	FJUMT-02-...	Difference (%)
FJZMT-02-08	08*	25	45	+80	192	256	+33
FJUMT-02-10	10	29	52	+80	145	250	+72
FJUMT-02-12	12	32	57	+78	186	324	+74
FJUMT-02-16	16	36	70	+94	280	464	+66
FJUMT-02-20	20	45	80	+78	440	580	+32
FJUMT-02-25	25	58	112	+93	712	975	+37
FJUMT-02-30	30	68	123	+81	1005	1470	+46
FJUMT-02-40	40	80	151	+89	1580	2360	+49
FJUMT-02-50	50	100	192	+92	2475	3450	+39

* FJZMT-02-08 are equipped with 2 pieces JSM-0810-12

* Nominal widths under 10mm are delivered with pressfit sleeve bearings

Telephone 1-800-521-2747
Fax 1-401-438-7270

Internet: <http://www.igus.com>
email: sales@igus.com
QuickSpec: <http://www.igus.com/iglide-quickspec>

RQA - Quad block, Closed, mm

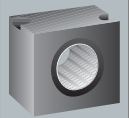

Quad block, with DryLin® R linear bearings

Special Properties

- Housing: aluminum
- Equipped with DryLin® R linear plain bearings, part no. RJUM-01-ø, RJUM-03-ø, or RJM-01
- Bearings are secured with retaining rings according to DIN 472
- Mounting bolts DIN 912-8.8, lock washer DIN 7980

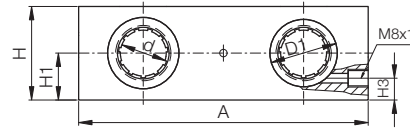

Also available as driven systems



HTS Page 30.17

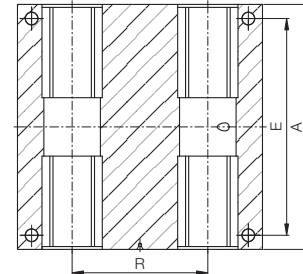
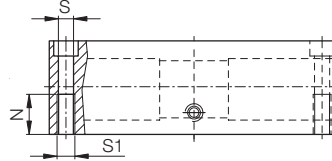

For a Low Clearance version use part number RQA-31-XX for standard RQA-33-XX for self-aligning

Dimensions (mm)

Standard with RJUM-01	Self-Aligning with RJUM-03	All Plastic with RJM-01	d	D1	A	H	H1	H3	R	N	E	S	S1
RQA-01-08	RQA-03-08	RQA-04-08	8	16	65	23	11.5	8	32	11	55	4.3	M5
RQA-01-12	RQA-03-12	RQA-04-12	12	22	85	32	16	13	42	13	73	5.3	M6
RQA-01-16	RQA-03-16	RQA-04-16	16	26	100	36	18	15	54	13	88	5.3	M6
RQA-01-20	RQA-03-20	RQA-04-20	20	32	130	46	23	19	72	18	115	6.6	M8
RQA-01-25	RQA-03-25	RQA-04-25	25	40	160	56	28	24	88	22	140	8.4	M10
RQA-01-30	RQA-03-30	RQA-04-30	30	47	180	64	32	27	96	26	158	10.5	M12
RQA-01-40	RQA-03-40	RQA-04-40	40	62	230	80	40	35	122	34	202	13.5	M16

OQA - Quad Block, Open, mm



Quad block open with DryLin® R linear bearings

Special Properties

- Housing: aluminum
- Equipped with DryLin® R linear plain bearings, Part no. OJUM-01-ø or OJUM-03-ø
- Maintenance-free
- Mounting bolts DIN 912-8.8, lock washer DIN 7980
- Securing of the bearing in the housing is done using set screws

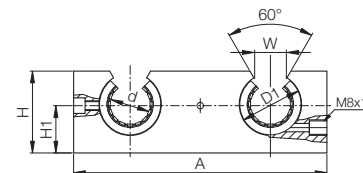
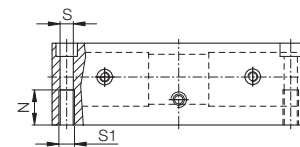
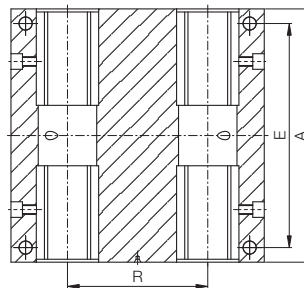

For a Low Clearance version use part number OQA-31-XX for standard OQA-33-XX for self-aligning

Dimensions (mm)

Standard with OJUM-01	Self-Aligning with OJUM-03	d	D1	A	H	H1	W	R	N	E	S	S1
OQA-01-12	OQA-03-12	12	22	85	30	18	14	42	13	73	5.3	M6
OQA-01-16	OQA-03-16	16	26	100	35	22	17	54	13	88	5.3	M6
OQA-01-20	OQA-03-20	20	32	130	42	25	17	72	18	115	6.8	M8
OQA-01-25	OQA-03-25	25	40	160	51	30	21	88	22	140	9.0	M10
OQA-01-30	OQA-03-30	30	47	180	60	35	21	96	26	158	10.5	M12
OQA-01-40	OQA-03-40	40	62	230	77	45	27	122	34	202	13.5	M16

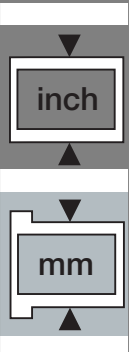

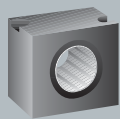

RTA - Pillow Block, Closed, Twin Design, mm

Special Properties

- Housing: aluminum
- Equipped with DryLin® R linear plain bearings, part no. RJUM-01-ø, RJUM-03-ø or RJM-01
- Can be combined with DryLin® R housing bearing, Part No. RJUM-06-ø
- Bearings are secured with retaining rings according to DIN 472
- Mounting bolts DIN 912-8.8, lock washer DIN 7980



Pillow block, twin design with DryLin® R linear plain bearings

For a Low Clearance version use part number
RTA-31-XX for standard
RTA-33-XX for self-aligning

Dimensions (mm)

Part No. Standard with RJUM-01	Self-Aligning with RJUM-03	All Plastic with RJM-0	d	D H6	H	H1 +0.01 -0.02	H2	H3	H4	S1	B	L +0.3	M ±0.02	E1 ±0.15	E2 ±0.15	d1	d2
RTA-01-08	-	RTA-04-08	8	16	28	13	13	8	14	M 5	35	62	17.5	35	25	4.20	8
RTA-01-12	RTA-03-12	RTA-04-12	12	22	35	18	13	10	25	M 6	43	76	21.5	40	30	5.20	10
RTA-01-16	RTA-03-16	RTA-04-16	16	26	42	22	13	12	30	M 6	53	84	26.5	45	36	5.20	10
RTA-01-20	RTA-03-20	RTA-04-20	20	32	50	25	18	13	24	M 8	60	104	30.0	55	45	6.80	11
RTA-01-25	RTA-03-25	RTA-04-25	25	40	60	30	22	15	40	M10	78	130	39.0	70	54	8.60	15
RTA-01-30	RTA-03-30	RTA-04-30	30	47	70	35	26	16	48	M12	87	152	43.5	85	62	10.30	18
RTA-01-40	RTA-03-40	RTA-04-40	40	62	90	45	34	20	60	M16	108	176	54.0	100	80	14.25	20

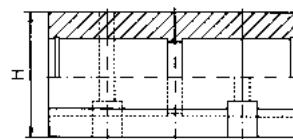
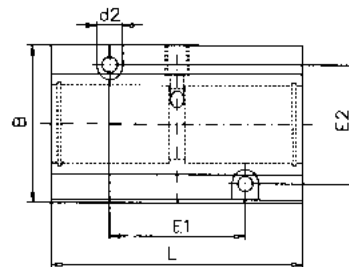
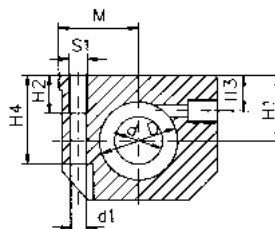

OTA - Pillow Block, Open, Twin Design, mm

Special Properties

- Housing: aluminum
- Equipped with DryLin® R linear plain bearings, Part No. OJUM-01-ø or OJUM-03-ø
- Can be combined with DryLin® R housing bearing, Part No. OJUM-06-ø
- Securing of the bearing in the housing is done using set screws
- Mounting bolts DIN 912-8.8, washer DIN 7980



Pillow block, twin design, open with DryLin® R linear plain bearings

For a Low Clearance version use part number
OTA-31-XX for standard
OTA-33-XX for self-aligning

Dimensions (mm)

Part No. Standard with OJUM-01	Self-Aligning with OJUM-03	d	D H6	H	H1 +0.01 -0.02	H2	H3	H4	S1	B	L +0.3	M ±0.02	E1 ±0.15	E2 ±0.15	d1	d2	W
OTA-01-12	OTA-03-12	12	22	30	18	13	10	25	M 6	43	76	21.5	40	30	5.20	10	14
OTA-01-16	OTA-03-16	16	26	35	22	13	12	30	M 6	53	84	26.5	45	36	5.20	10	17
OTA-01-20	OTA-03-20	20	32	42	25	18	13	24	M 8	60	104	30.0	55	45	6.80	11	17
OTA-01-25	OTA-03-25	25	40	51	30	22	15	40	M10	78	130	29.0	70	54	8.60	15	21
OTA-01-30	OTA-03-30	30	47	60	35	26	16	48	M12	87	152	43.5	85	62	10.30	18	21
OTA-01-40	OTA-03-40	40	62	77	45	34	20	60	M16	108	176	54.0	100	80	14.25	20	27

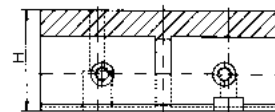
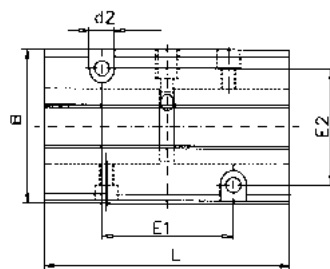
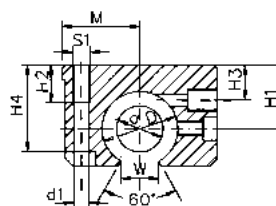

RGA Pillow Block, Closed, Long Design, mm

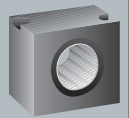

DryLin® R
Linear Guide Systems

PDF: www.igus.com/iglide-pdfs
CAD: www.igus.com/iglide-CAD
RoHS info: www.igus.com/RoHS



inch

mm

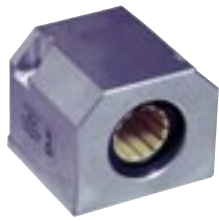

Special Properties

- Housing: aluminum
- Equipped with DryLin® R linear plain bearings, Part No. RJUM-01-ø, RJUM-03-ø or RJM-01
- Can be combined with DryLin® R housing bearing, Part No. RJUM-06-ø
- Bearings are secured with retaining rings according to DIN 472

For a Low Clearance version
use part number
RGA-31-XX for standard
RGA-33-XX for self-aligning

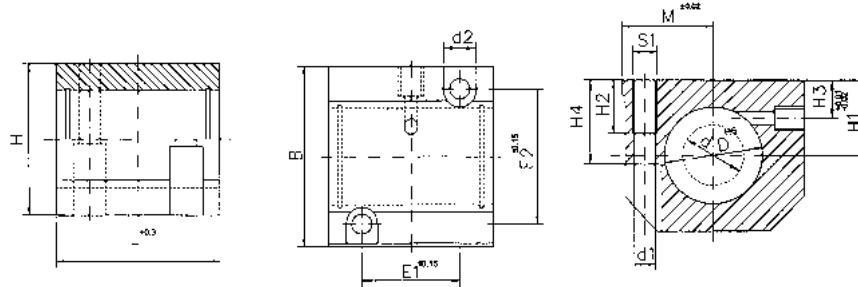

Dimensions (mm)

Part No. Standard with RJUM-01	Self-Aligning with RJUM-03	All Plastic with RJM-01	d	D H6	H	H1 +0.01 -0.02	H2	H3	H4	S1	B	L ±0.03	M ±0.15	E1 ±0.15	E2	d1	d2
RGA-01-08	-	RGA-04-08	8	16	28	13	10	8	14	M 4	35	32	17.5	20	25	3.2	6
RGA-01-12	RGA-03-12	RGA-04-12	12	22	35	18	11	10	25	M 5	43	39	21.5	23	32	4.2	6
RGA-01-16	RGA-03-16	RGA-04-16	16	26	42	22	13	12	30	M 6	53	43	26.5	26	40	5.2	10
RGA-01-20	RGA-03-20	RGA-04-20	20	32	50	25	18	13	24	M 8	60	54	30.0	32	45	6.8	11
RGA-01-25	RGA-03-25	RGA-04-25	25	40	60	30	22	15	40	M10	78	67	39.0	40	60	8.6	15
RGA-01-30	RGA-03-30	RGA-04-30	30	47	70	35	22	16	48	M10	87	79	43.5	45	68	8.6	15
RGA-01-40	RGA-03-40	RGA-04-40	40	62	90	45	26	20	60	M12	108	91	54.0	58	86	10.3	18

OGA Pillow Block, Open, Long Design, mm



Special Properties

- Housing: aluminum
- Equipped with DryLin® linear plain bearings OJUM-01-ø or OJUM-03-ø
- Can be combined with DryLin® R housing bearing OJUM-06-ø
- Bearings are secured with retaining rings according to DIN 472

For a Low Clearance version
use part number
OGA-31-XX for standard
OGA-33-XX for self-aligning

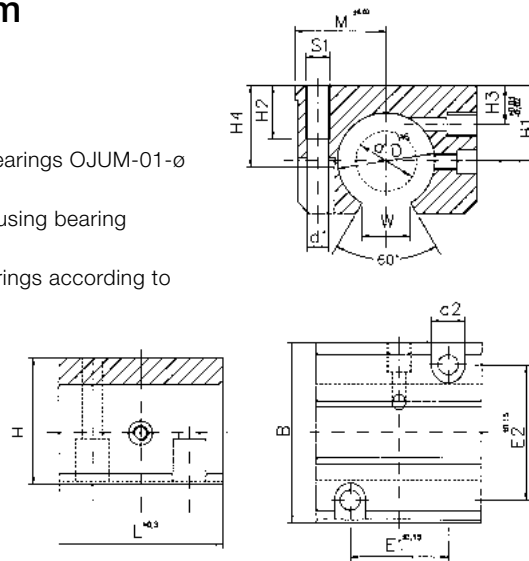

Dimensions (mm)

Part No.. Standard with OJUM-01	Self-Aligning with OJUM-03	d	D H6	H	H1 +0.01 -0.02	H2	H3	H4	S1	B +0.3	L ±0.03	M ±0.15	E1 ±0.15	E2	d1	d2	W +0.6
OGA-01-12	OGA-03-12	12	22	28	18	11	8	25	M 5	43	39	21.5	23	32	4.2	8	14
OGA-01-16	OGA-03-16	16	26	35	22	13	12	30	M 6	53	43	26.5	26	40	5.2	10	17
OGA-01-20	OGA-03-20	20	32	42	25	18	13	24	M 8	60	54	30.0	32	45	6.8	11	17
OGA-01-25	OGA-03-25	25	40	51	30	22	15	40	M10	78	67	39.0	40	60	8.6	15	21
OGA-01-30	OGA-03-30	30	47	60	35	22	16	48	M10	87	79	43.5	45	68	8.6	15	21
OGA-01-40	OGA-03-40	40	62	77	45	26	20	60	M12	108	91	54.0	58	86	10.3	18	27

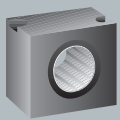

RGAS Pillow Block, Closed, Short Design, mm

DryLin® R
Linear Guide Systems

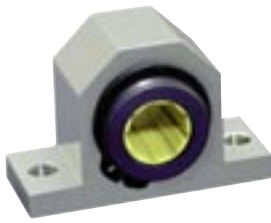

Special Properties

- Housing: aluminum
- Equipped with DryLin® R linear plain bearings, Part No. RJUM-01-ø, RJUM-03-ø or RJM-01
- Can be combined with DryLin® R housing bearing RJUM-06-ø
- Bearings are secured with retaining rings according to DIN 472

For a Low Clearance version
use part number
RGAS-31-XX for standard
RGAS-33-XX for self-aligning

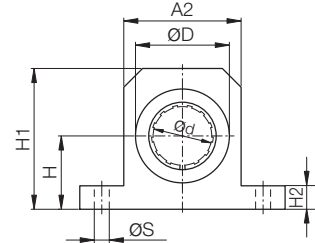
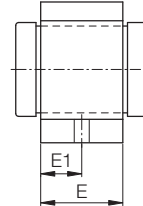
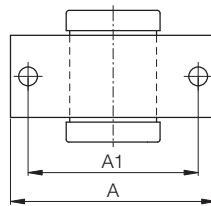

Dimensions (mm)

Part No. Standard with RJUM-01	Self-Aligning with RJUM-03	All Plastic with RJM-01	d	D	H	H1	A	A1	A2	E	E1	S
RGAS-01-12	RGAS-03-12	RGAS-04-12	12	22	18	35	52	42	30	20	10	5.3
RGAS-01-16	RGAS-03-16	RGAS-04-16	16	26	22	40.5	56	46	34	22	11	5.3
RGAS-01-20	RGAS-03-20	RGAS-04-20	20	32	25	48.0	70	58	40	28	14	6.4
RGAS-01-25	RGAS-03-25	RGAS-04-25	25	40	30	58.0	80	68	50	40	20	6.4
RGAS-01-30	RGAS-03-30	RGAS-04-30	30	47	35	67.0	88	76	58	48	24	6.4
RGAS-01-40	RGAS-03-40	RGAS-04-40	40	62	45	85.0	108	94	74	56	28	8.4

Telephone 1-800-521-2747
Fax 1-401-438-7270

OGAS Pillow Block, Open, Short Design, mm



Special Properties

- Housing: aluminum
- Equipped with DryLin® R linear plain bearings, Part No. OJUM-01-ø or OJUM-03-ø
- Can be combined with DryLin® R housing bearing, Part No. OJUM-06-ø
- Securing of the bearing in the housing is done using set screws

For a Low Clearance version
use part number
OGAS-31-XX for standard
OGAS-33-XX for self-aligning

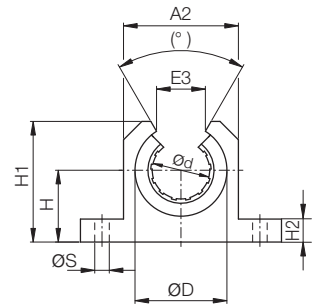
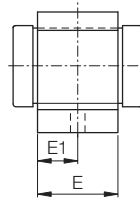
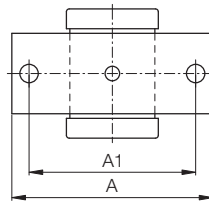

Dimensions (mm)

Part No. Standard with OJUM-01	Self-Aligning with OJUM-03	d	D	H	H1	A	A1	A2	E	E1	E3	(°)	S
OGAS-01-12	OGAS-03-12	12	22	18	28	52	42	30	20	10	14	78	5.3
OGAS-01-16	OGAS-03-16	16	26	22	33.5	56	46	34	22	11	17	78	5.3
OGAS-01-20	OGAS-03-20	20	32	25	42	70	58	40	28	14	17	60	6.4
OGAS-01-25	OGAS-03-25	25	40	30	51	80	68	50	40	20	21	60	6.4
OGAS-01-30	OGAS-03-30	30	47	35	60	88	76	58	48	24	21	54	6.4
OGAS-01-40	OGAS-03-40	40	62	45	77	108	94	74	56	28	27	54	8.4

Internet: <http://www.igus.com>
email: sales@igus.com
QuickSpec: <http://www.igus.com/iglide-quickspec>



igus® testing method for determining the tolerance of DryLin® Linear Plain Bearings

In order to ensure the function of the DryLin® linear plain bearing, it is necessary to use the bearing with a defined clearance. The quality control of this product line is performed with a cylinder gauge test. For this

purpose, a certain force is defined, with which the cylinder gauge is loaded when the plain bearing is tested.

Part	Test Force (lbs)	Test Housing i.d.	min. Bearing ϕ_i (Cylinder Gauge Free)	max. Bearing ϕ_i (Cylinder Gauge Hangs)
JUM-01/02-10	0.221	12.000 mm	10.030 mm	10.070 mm
JUM-01/02-12	0.309	14.000 mm	12.030 mm	12.070 mm
JUM-01/02-16	0.419	18.000 mm	16.030 mm	16.070 mm
JUM-01/02-20	0.595	23.000 mm	20.030 mm	20.070 mm
JUM-01/02-25	0.838	28.000 mm	25.030 mm	25.070 mm
JUM-01/02-30	1.081	34.000 mm	30.040 mm	30.085 mm
JUM-01/02-40	1.588	44.000 mm	40.040 mm	40.085 mm
JUM-01/02-50	2.205	55.000 mm	50.050 mm	50.100 mm
JUI-01-06	0.221	0.4684 inch	0.3768 inch	0.3776 inch
JUI-01-08	0.309	0.5934 inch	0.5016 inch	0.5024 inch
JUI-01-10	0.419	0.7184 inch	0.6268 inch	0.6276 inch
JUI-01-12	0.595	0.8747 inch	0.7516 inch	0.7524 inch
JUI-01-16	0.838	1.1247 inch	1.0016 inch	1.0024 inch
JUI-01-20	1.081	1.4058 inch	1.2520 inch	1.2531 inch
JUI-01-24	1.588	1.6558 inch	1.5020 inch	1.5031 inch
JUI-01-32	2.205	2.1870 inch	2.0024 inch	2.0039 inch
RJM-01-08	0.221	16.000 mm	8.025 mm	8.061 mm
RJM-01-10	0.221	19.000 mm	10.025 mm	10.061 mm
RJM-01-12	0.309	22.000 mm	12.032 mm	12.075 mm
RJM-01-16	0.419	26.000 mm	16.032 mm	16.075 mm
RJM-01-20	0.595	32.000 mm	20.040 mm	20.092 mm
RJM-01-25	0.838	40.000 mm	25.040 mm	25.092 mm
RJM-01-30	1.081	47.000 mm	30.040 mm	30.092 mm
RJM-01-40	1.588	62.000 mm	40.050 mm	40.112 mm
RJM-01-50	2.205	75.000 mm	50.050 mm	50.112 mm
RJI-01-06	0.221	0.6250 inch	0.3762 inch	0.3776 inch
RJI-01-08	0.309	0.8750 inch	0.5013 inch	0.5030 inch
RJI-01-10	0.419	1.1250 inch	0.6265 inch	0.6282 inch
RJI-01-12	0.595	1.2500 inch	0.7516 inch	0.7536 inch
RJI-01-16	0.838	1.5625 inch	1.0035 inch	1.0056 inch
RJI-01-20	1.081	2.0000 inch	1.2520 inch	1.2544 inch
RJI-01-24	1.588	2.3750 inch	1.5020 inch	1.5044 inch
RJI-01-32	2.205	3.0000 inch	2.0024 inch	2.0053 inch

When using a plain bearing (JUM/RJM..) in connection with an adapter/housing (RJUM, OJUM, RGA..) the manufacturing tolerance of the housing bore (standard case: H7) is also added to the minimum play listed above. The total from these two values then produces the maximum possible bearing tolerance.





DryLin® R Linear Plain Bearing

DryLin® R
Linear Guide Systems

Telephone 1-800-521-2747
Fax 1-401-438-7270

Internet: <http://www.igus.com>
email: sales@igus.com
QuickSpec: <http://www.igus.com/iglide-quickspec>

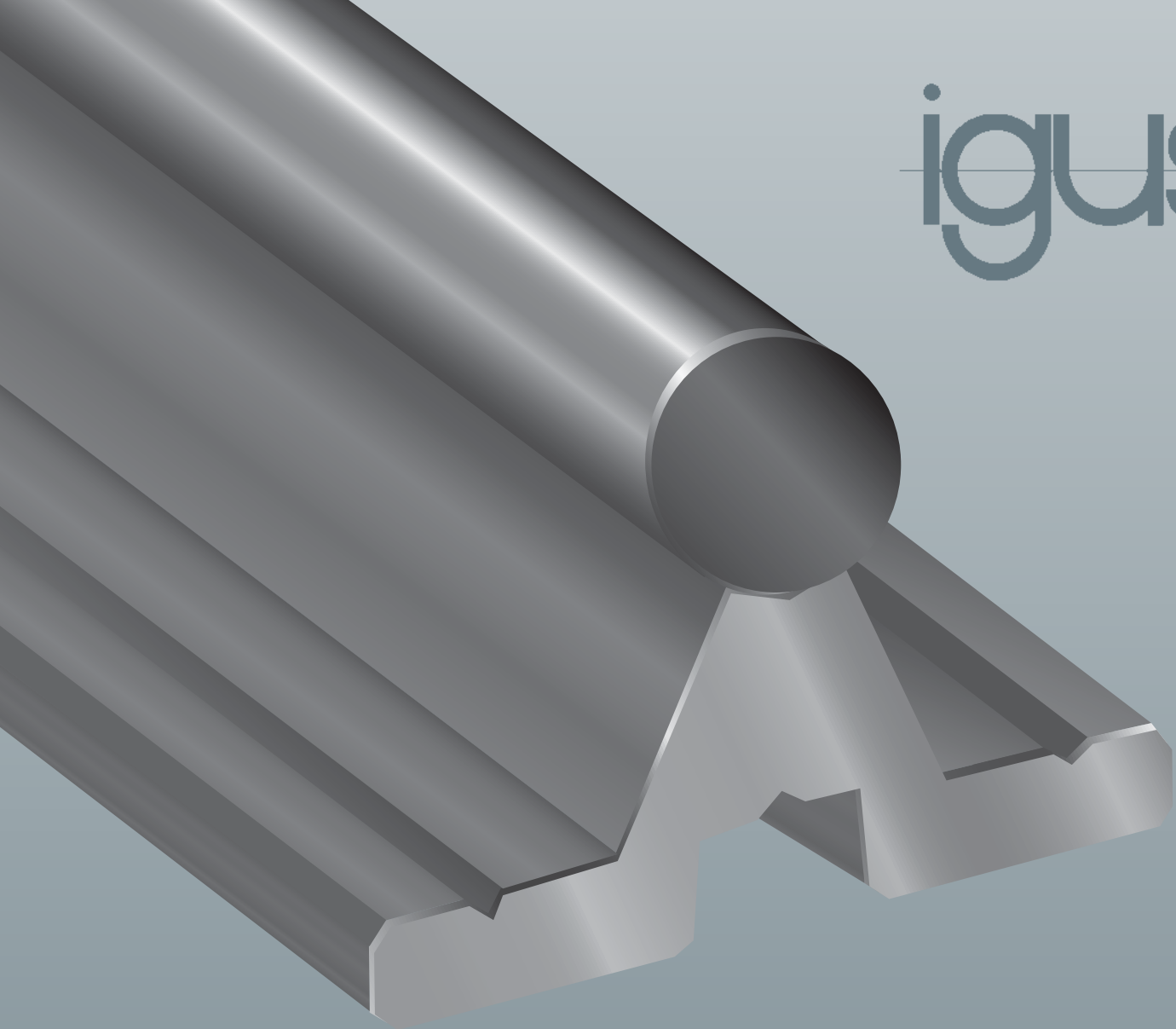

DryLin[®] Metric Shafting

- Supported shafts available
- Lightweight aluminum
- Corrosion-resistant stainless steel
- Diameters from 6 to 50 mm



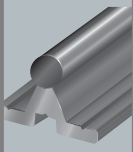

DryLin® Metric Shafting

DryLin® R
Linear Guide Systems

Telephone 1-800-521-2747
1-401-438-7270
Fax

Internet: <http://www.igus.com>
email: sales@igus.com
QuickSpec: <http://www.igus.com/iglide-quickspec>

29.60

	Aluminum			Steel				Stainless, hardened				Soft Stainless	
	AWM	AWUM	AWMR	SWUM	SWUMN	SWMH	SWUMHN	EWUM	EWUMN	EEWM	EEWUMN	EWMR	EWMS
Material	EN AW 6061/6063			Case hardened		Hard chromed		440c		420c		304	316
Ø 6	●			▲		▲		▲ ²		▲			
Ø 8	●			▲		▲		▲ ²		▲			
Ø 10	●	●		▲		▲		▲ ²		▲		▲	▲
Ø 12	●	●		▲	▲	▲	▲	▲	▲	▲	▲	▲	■
Ø 16	●	●		▲	▲	▲	▲	▲	▲	▲	▲	▲	■
Ø 20	●	●	●	▲	▲	▲	▲	▲	▲	▲	▲	▲	▲
Ø 25	●	●	●	▲	▲	▲	▲	▲	▲	▲	▲	▲	■
Ø 30	● ¹	●		▲	▲	▲	▲	▲	▲	▲	▲	▲	■
Ø 40	● ¹	●		▲	▲	▲	▲	▲	▲	▲			
Ø 50	● ¹			▲	▲	▲	▲	▲	▲	▲			
Tolerance	h8	-0.1	h9	h6	h6	h7	h7	h6	h6	h6	h6	h9	h9
Max. Length Ø 8-10	3000			3000		3000		3000		3000			
Max. Length Ø12-50	3000	4000	3000	6000	6000	6000	6000	6000	6000	6000	6000	3000	3000
Surface	Hard Anodized			Hardened/Ground		Hard Chrome		Hardened/Ground		Hardened/Ground		Drawn/Polished	
Surface Roughness	<0.6			0.15 - 0.3		0.15 - 0.3		0.15 - 0.3		0.15 - 0.3		0.3 - 0.6	
Surface Hardness	450-550 HV			60+4 HRC		60+4 HRC		52+8 HRC		52+8 HRC		Non Hardened	
Roundness	DIN EN 12020			<1/2 Tolerance		<1/2 Tolerance		<1/2 Tolerance		<1/2 Tolerance		<1/2 Tolerance	

Inch sizes are also available. See Page 29.23

ISO Tolerances for Shafts (ISO 286-2)

Over Including	Nominal Shaft Size (mm)						
	3 6	6 10	10 18	18 30	30 40	40 50	50 65
h6	+0/-0.008	+0/-0.009	+0/-0.011	+0/-0.013	+0/-0.016	+0/-0.016	+0/-0.019
h7	+0/-0.012	+0/-0.015	+0/-0.018	+0/-0.021	+0/-0.025	+0/-0.025	+0/-0.030
h8	+0/-0.018	+0/-0.022	+0/-0.027	+0/-0.033	+0/-0.039	+0/-0.039	+0/-0.046
h9	+0/-0.030	+0/-0.036	+0/-0.043	+0/-0.052	+0/-0.062	+0/-0.062	+0/-0.074
h10	+0/-0.048	+0/-0.058	+0/-0.070	+0/-0.084	+0/-0.100	+0/-0.100	+0/-0.120

Order Example

AWUM -12 -500 -T1

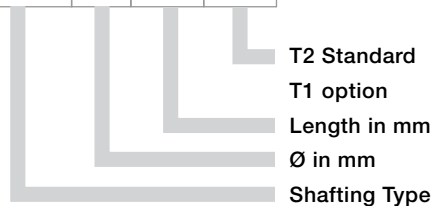

Example:
AWUM-12-500 hard anodized aluminum shaft,
12 mm OD, 500 mm length

DryLin® S Aluminum Shaft, mm

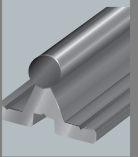

Properties

Material: EN AW 6061/6060
Tolerance: h8
Roundness: DIN 1798
Straightness: DIN 1798
Hardness: 75 HB
Surface: hard-anodized

Surface Hardness: 450-550 HV
Spec. Electr. Resistance: $4 \cdot 10^{11}$ Ohm mm²/m
Chemical Resistance: $2 < \text{pH} < 9$

Dimensions (mm)

Part No.	Design	OD	Wall Thickness	ID	Max. Length	Weight (kg/m)
AWM-06- L in mm	Solid	6	-	-	3000	0.08
AWM-08- L in mm	Solid	8	-	-	3000	0.14
AWM-10- L in mm	Solid	10	-	-	3000	0.22
AWM-12- L in mm	Solid	12	-	-	3000	0.32
AWM-16- L in mm	Solid	16	-	-	3000	0.56
AWM-20- L in mm	Solid	20	-	-	3000	0.88
AWMR-20- L in mm	Hollow	20	2	16	3000	0.32
AWM-25- L in mm	Solid	25	-	-	3000	1.37
AWMR-25- L in mm	Hollow	30	3	19	3000	0.59
AWM-30- L in mm	Hollow	30 x 7.5	7.5	-	3000	1.48
AWM-40- L in mm	Hollow	40 x 10	10	20	3000	2.63
AWM-50- L in mm	Hollow	50 x 11	11	28	3000	3.75

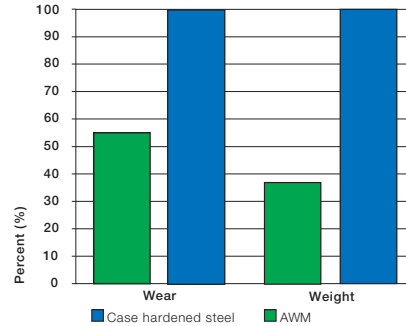

Order example: AWM-16-500 corresponds to an aluminum shaft diameter of 16mm, 500 mm long
Inch sizes are also available. See Page 29.23

Comparison of wear with iglide® J and weight between DryLin® aluminum shafts and cold rolled steel

DryLin® Supported Aluminum Shaft, mm

Properties



Material: EN 6061/6060/6063
Roundness: DIN 1798
Straightness: DIN 1798
Hardness: 75 HB

Surface: hard-anodized. oxidation (wear-resistant Al-oxide)
Surface Hardness: 450-550 HV
Spec. Electr. Resistance: $4 \cdot 10^{11}$ Ohm mm²/m
Chemical Resistance: $2 < \text{pH} < 9$

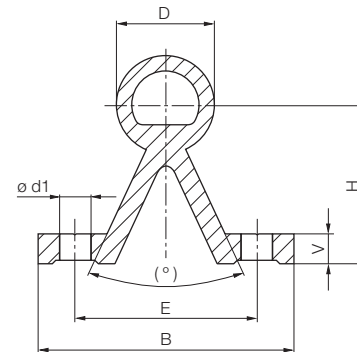
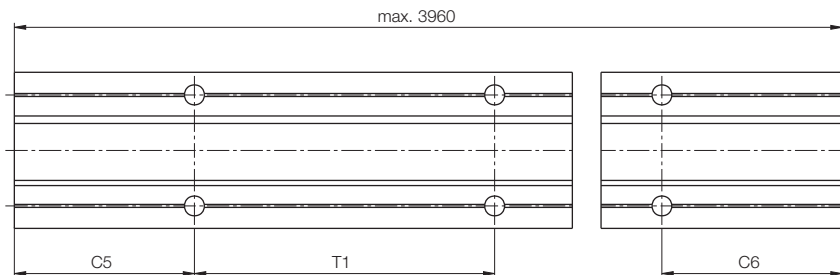

Dimensions (mm)

Part No.	D	B	H	V	d1	(°)	E	Bore Hole Spacing T1	C5/C6		Max. Length	Weight (kg/m)
	-0.1		±0.25				±0.15		min.	max.		
AWUM-12- L in mm	12	40	22	5	4.5	50	29	75	20	57	3950	0.750
AWUM-16- L in mm	16	45	26	5	5.5	50	33	100	20	69	3950	1.000
AWUM-20- L in mm	20	52	32	6	6.6	50	37	100	20	69	3950	1.415
AWUM-25- L in mm	25	57	36	6	6.6	50	42	120	20	79	3950	1.805
AWUM-30- L in mm	30	69	42	7	9.0	50	51	150	20	94	3950	2.690

Order example: AWUM-16-500 corresponds to supported aluminum shaft diameter 16 mm, 500 mm long

DryLin® R
Linear Guide Systems

PDF: www.igus.com/iglide-pdfs
 CAD: www.igus.com/iglide-CAD
 RoHS info: www.igus.com/RoHS



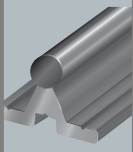

- Materials available
1050 Case Hardened Steel
1050 Case Hardened, Chrome-plated Steel
- Available supported or unsupported
- Max undersupport rail length - 600 mm
- T2 hole spacing standard
T1 optional
- Symmetric hole pattern C5 = C6



DryLin® R
Linear Guide Systems

Telephone 1-800-521-2747
Fax 1-401-438-7270

Internet: <http://www.igus.com>
email: sales@igus.com
QuickSpec: <http://www.igus.com/iglide-quickspec>

Dimensions (mm) – Case hardened steel (1050)

Part No.	d Tolerance ISO h6	Weight (kg/m)	Max. Length (mm)	Hardness Depth (mm)
SWM-06	06	0.222	3000	0.8
SWM-08	08	0.359	4000	0.9
SWM-10	10	0.617	4000	0.9
SWM-12	12	0.888	6000	1.0
SWM-16	16	1.578	6000	1.2
SWM-20	20	2.466	6000	1.6
SWM-25	25	3.853	6000	1.8
SWM-30	30	5.549	6000	2.0
SWM-40	40	9.865	6000	2.2
SWM-50	50	15.413	6000	2.4

Dimensions (mm) – Chrome-plated case hardened steel (1050)

Part No.	d Tolerance ISO h7	Weight (kg/m)	Max. Length (mm)	Hardness Depth (mm)
SWMH-06	06	0.222	3000	0.8
SWMH-08	08	0.359	4000	0.9
SWMH-10	10	0.617	4000	0.9
SWMH-12	12	0.888	6000	1.0
SWMH-16	16	1.578	6000	1.2
SWMH-20	20	2.466	6000	1.6
SWMH-25	25	3.853	6000	1.8
SWMH-30	30	5.549	6000	2.0
SWMH-40	40	9.865	6000	2.2
SWMH-50	50	15.413	6000	2.4

Order example: SWM-16-500 corresponds to supported aluminum shaft diameter 16 mm, 500 mm long

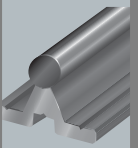

SWUM

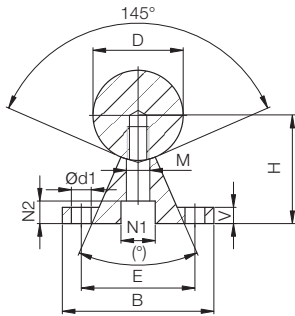

SWUMN

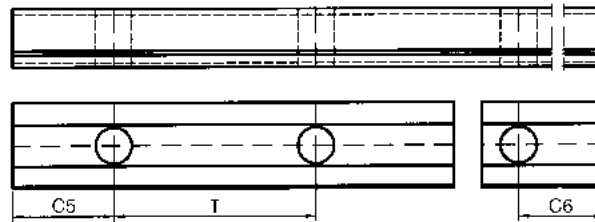
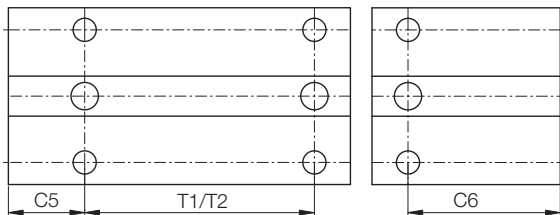
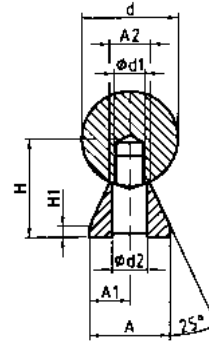

Dimensions (mm) – Case hardened steel (1050)

Part No.	D (mm)	B (mm)	H (mm)	V (mm)	N1 (mm)	N2 (mm)	d1 (mm)	M (mm)	(°)	E (mm)	T1* (mm)	C5/C6		T2 (mm)	C5/C6		Weight (kg/m)
												min.	max.		min.	max.	
	h6		±0.02								±0.15	for T1		Standard	for T2 Standard		
SWUM-12	12	40	22	5	8.0	5.0	4.5	5.8	50	29	75	20	57	120	20	79	1.75
SWUM-16	16	45	26	5	9.5	6.0	5.5	7.0	50	33	100	20	69	150	20	94	2.64
SWUM-20	20	52	32	6	11.0	6.5	6.6	8.3	50	37	100	20	69	150	20	94	3.97
SWUM-25	25	57	36	6	14.0	8.5	6.6	10.8	50	42	120	20	79	200	20	119	5.65
SWUM-30	30	69	42	7	17.0	10.5	9.0	11.0	50	51	150	20	94	200	20	119	7.93
SWUM-40	40	73	50	8	17.0	10.5	9.0	15.0	50	55	200	20	119	300	20	169	12.88
SWUM-50	50	84	60	9	19.0	12.5	11.0	19.0	46	63	200	20	119	300	20	169	19.60

* T1 optional, T2 standard

For chrome-plated supported shafting use part number SWMH-XX, tolerance is h7

Dimensions (mm) – Case hardened steel (1050)

Part No.	d (mm)	H (mm)	H1 (mm)	A (mm)	A1 (mm)	A2 (mm)	d1	d2 (mm)	T (mm)	C5/C6 min.	C5/C6 max.	Weight (kg/m)
SWUMN-12	12	14.5	3	11	5.5	5.4	M4	4.5	75	20	57	1.62
SWUMN-16	16	18	3	14	7.0	7.0	M5	5.5	75	20	57	2.54
SWUMN-20	20	22	3	17	8.5	8.1	M6	6.6	75	20	57	3.81
SWUMN-25	25	26	3	21	10.5	10.3	M8	9.0	75	20	57	5.62
SWUMN-30	30	30	3	23	11.5	11.0	M10	11.0	100	20	69.5	7.63
SWUMN-40	40	39	4	30	15.0	15.0	M12	13.5	100	20	69.5	13.47
SWUMN-50	50	46	5	35	17.5	19.0	M14	15.5	100	20	69.5	20.31

Narrow undersupported rail comes unassembled

For chrome-plated supported shafting use part number SWUMHN-XX, tolerance is h7

DryLin® R
Linear Guide Systems

PDF: www.igus.com/iglide-pdfs
CAD: www.igus.com/iglide-CAD
RoHS info: www.igus.com/RoHS

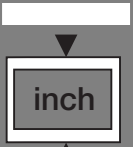

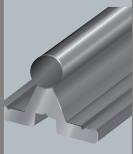

DryLin® R Stainless Steel Shafting - EWM / EEWM / EWMR / EWMS

DryLin® R
Linear Guide Systems

Telephone 1-800-521-2747
Fax 1-401-438-7270

Internet: <http://www.igus.com>
email: sales@igus.com
QuickSpec: <http://www.igus.com/iglide-quickspec>

29.64



- Materials available
(440c) Hard stainless
(420c) Hard stainless
(304) Soft stainless
(316) Soft stainless
- Supported or unsupported
- T2 hole spacing standard, T1 optional
- Max undersupport rail length - 600 mm
- Symmetric hole pattern C5 = C6

Dimensions (mm) – Hardened Stainless (440c/1.4125)

Part No.	d ISO h6	Weight (kg/m)	Max. Length (mm)	Hardness Depth (mm)
EWM-06	06	0.222	3000	0.8
EWM-08	08	0.359	4000	0.9
EWM-10	10	0.617	4000	0.9
EWM-12	12	0.888	6000	1.0
EWM-16	16	1.578	6000	1.2
EWM-20	20	2.466	6000	1.6
EWM-25	25	3.853	6000	1.8
EWM-30	30	5.549	6000	2.0
EWM-40	40	9.865	6000	2.2
EWM-50	50	15.413	6000	2.4

Dimensions (mm) – Hardened Stainless (420c/1.4034)

Part No.	d ISO h6	Weight (kg/m)	Max. Length (mm)	Hardness Depth (mm)
EEWM-06	06	0.222	3000	0.8
EEWM-08	08	0.359	4000	0.9
EEWM-10	10	0.617	4000	0.9
EEWM-12	12	0.888	6000	1.0
EEWM-16	16	1.578	6000	1.2
EEWM-20	20	2.466	6000	1.6
EEWM-25	25	3.853	6000	1.8
EEWM-30	30	5.549	6000	2.0
EEWM-40	40	9.865	6000	2.2
EEWM-50	50	15.413	6000	2.4

Dimensions (mm) – Soft Stainless (304/1.4301)

Part No.	d ISO h9	Weight (kg/m)	Max. Length (mm)
EWMR-10	10	0.617	4000
EWMR-12	12	0.888	6000
EWMR-16	16	1.578	6000
EWMR-20	20	2.466	6000
EWMR-25	25	3.853	6000
EWMR-30	30	5.549	6000

Dimensions (mm) – Soft Stainless (316/1.4571)

Part No.	d ISO h9	Weight (kg/m)	Max. Length (mm)
EWMS-10	10	0.617	4000
EWMS-20	20	2.466	6000

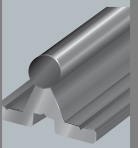

EWUMN

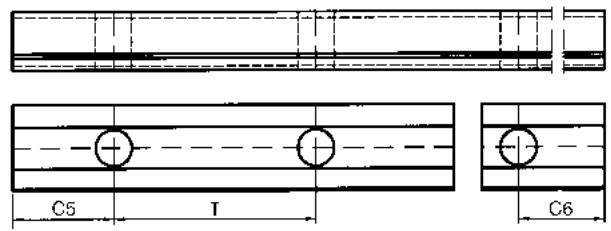
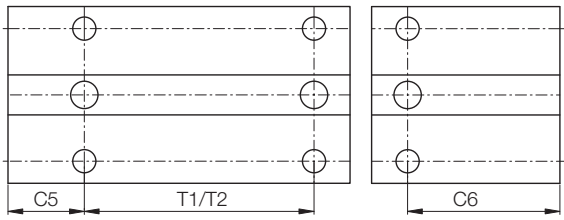
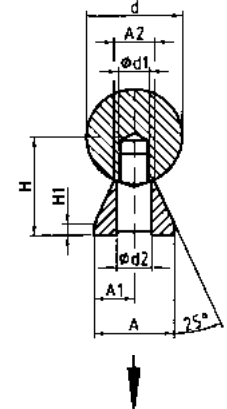
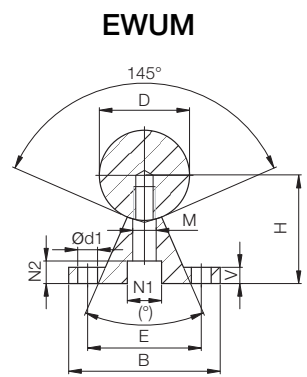

Dimensions (mm) – Supported Stainless (440c)

Part No.	D (mm) h6	B (mm)	H (mm) ±0.02	V (mm)	N1 (mm)	N2 (mm)	d1 (mm)	M (mm)	(°)	E (mm)	T1* (mm) ±0.15	C5/C6 min. max. for T1		T2 (mm) Standard	C5/C6 min. max. for T2 Standard		Weight (kg/m)
												min.	max.		min.	max.	
EWUM-12	12	40	22	5	8.0	5.0	4.5	5.8	50	29	75	20	57	120	20	79	1.75
EWUM-16	16	45	26	5	9.5	6.0	5.5	7.0	50	33	100	20	69	150	20	94	2.64
EWUM-20	20	52	32	6	11.0	6.5	6.6	8.3	50	37	100	20	69	150	20	94	3.97
EWUM-25	25	57	36	6	14.0	8.5	6.6	10.8	50	42	120	20	79	200	20	119	5.65
EWUM-30	30	69	42	7	17.0	10.5	9.0	11.0	50	51	150	20	94	200	20	119	7.93
EWUM-40	40	73	50	8	17.0	10.5	9.0	15.0	50	55	200	20	119	300	20	169	12.88
EWUM-50	50	84	60	9	19.0	12.5	11.0	19.0	46	63	200	20	119	300	20	169	19.60

* T1 optional, T2 standard

Dimensions (mm) – Narrow Supported Stainless (440c)

Part No.	d (mm) h6	H (mm)	H1 (mm) ±0.02	A (mm)	A1 (mm)	A2 (mm) ±0.02	d1	d2 (mm)	T (mm)	C5/C6 min.	C5/C6 max.	Weight (kg/m)
EWUMN-12	12	14.5	3	11	5.5	5.4	M4	4.5	75	20	57	1.62
EWUMN-16	16	18	3	14	7.0	7.0	M5	5.5	75	20	57	2.54
EWUMN-20	20	22	3	17	8.5	8.1	M6	6.6	75	20	57	3.81
EWUMN-25	25	26	3	21	10.5	10.3	M8	9.0	75	20	57	5.62
EWUMN-30	30	30	3	23	11.5	11.0	M10	11.0	100	20	69.5	7.63
EWUMN-40	40	39	4	30	15.0	15.0	M12	13.5	100	20	69.5	13.47
EWUMN-50	50	46	5	35	17.5	19.0	M14	15.5	100	20	69.5	20.31

Narrow supports are not assembled

Information icon (i) and unit selection buttons (inch, mm).

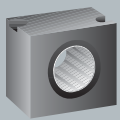

Special Properties

- Material: aluminum

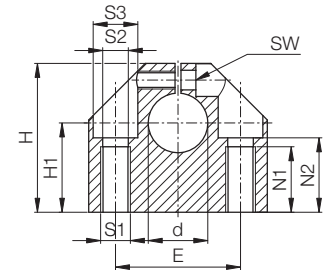
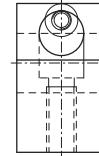
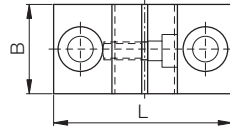

Dimensions (mm)

Part No.	d	B	H	H1 ±0,02	L	S1	S2	S3	E ±0,1	N1	N2	SW	Weight (kg)
WA-08	8	18	28	15	32	M4	3.3	6	22	9	13.0	2.5	0.04
WA-12	12	20	35	20	43	M6	5.2	10	30	13	16.5	3.0	0.10
WA-16	16	24	42	25	53	M8	6.8	11	38	18	21.0	4.0	0.15
WA-20	20	30	50	30	60	M10	8.6	15	42	22	25.0	5.0	0.23
WA-25	25	38	60	35	78	M12	10.3	18	56	26	30.0	6.0	0.41
WA-30	30	40	70	40	87	M12	10.3	18	64	26	34.0	6.0	0.53
WA-40	40	48	90	50	108	M16	14.25	20	82	34	44.0	8.0	0.99
WA-50*	50	58	105	60	132	M20	17.5	26	100	43	49.0	10.0	1.25

* on request

WAC Shaft Block, Compact Design, mm



Special Properties

- Material: aluminum

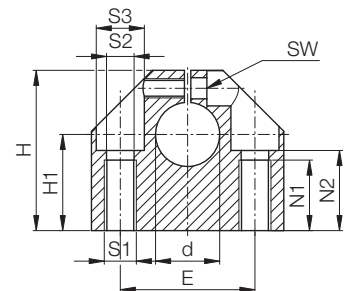
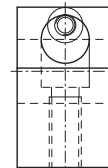
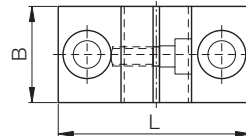

Dimensions (mm)

Part No.	d	B	H	H1 ±0.01	L	S1	S2	S3	E ±0.12	N1	N2	SW	Weight (kg)
WAC-06*	6	16	27	15	32	M5	4.2	8	22	11	13	2.5	0.03
WAC-08	8	16	27	16	32	M5	4.2	8	22	11	13	2.5	0.03
WAC-10	10	18	33	18	40	M6	5.2	10	27	13	16	3.0	0.05
WAC-12	12	18	33	19	40	M6	5.2	10	27	13	16	3.0	0.05
WAC-14*	14	20	38	20	45	M6	5.2	10	32	13	18	3.0	0.07
WAC-16	16	20	38	22	45	M6	5.2	10	32	13	18	3.0	0.07
WAC-20	20	24	45	25	53	M8	6.8	11	39	18	22	4.0	0.12
WAC-25	25	28	54	31	62	M10	8.6	15	44	22	26	5.0	0.17
WAC-30	30	30	60	34	67	M10	8.6	15	49	22	29	5.0	0.22
WAC-40	40	40	76	42	87	M12	10.3	18	66	26	38	6.0	0.48
WAC-50*	50	50	92	50	103	M16	14.25	20	80	34	46	8.0	0.82

* on request

WAS Shaft Block, Narrow Design, mm

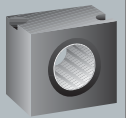

DryLin® R
Linear Guide Systems

PDF: www.igus.com/iglide-pdfs
CAD: www.igus.com/iglide-CAD
RoHS info: www.igus.com/RoHS



Special Properties

- Material: aluminum

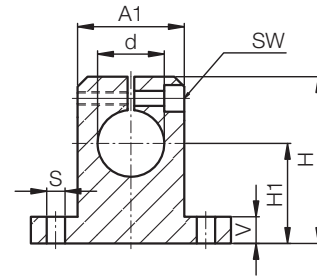
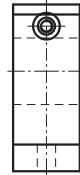
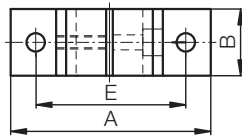

Dimensions (mm)

Part No.	d	H	H1 ±0.02	A	A1	B	E	S	V	SW	Weight (kg)
WAS-08	8	27	15	32	16	10	25	4.5	5.0	2.5	0.012
WAS-12	12	35	20	42	20	12	32	5.5	5.5	3.0	0.023
WAS-16	16	42	25	50	26	16	40	5.5	6.5	3.0	0.035
WAS-20	20	50	30	60	32	20	45	5.5	8.0	3.0	0.067
WAS-25	25	58	35	74	38	25	60	6.6	9.0	4.0	0.140
WAS-30	30	68	40	84	45	28	68	9.0	10.0	5.0	0.200
WAS-40	40	86	50	108	56	32	86	11.0	12.0	6.0	0.480



inch

mm

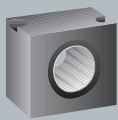

TA Shaft End Support, Movable*, mm

DryLin® R
Linear Guide Systems

Telephone 1-800-521-2747
1-401-438-7270
Fax



Special Properties

- Material: aluminum
- Thread hole mount

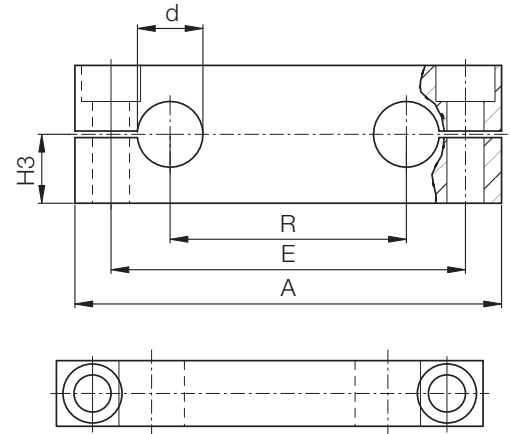
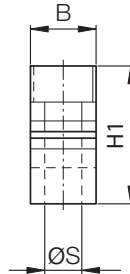

Dimensions (mm)

Part No.	d	A	B	H1	H3 ±0.015	S	E	R	Weight (kg)
TA-08	8	65	12	22	11	M5	52	32	0.04
TA-12	12	85	14	28	14	M6	70	42	0.07
TA-16	16	100	18	32	16	M8	82	54	0.13
TA-20	20	130	20	42	21	M10	108	72	0.22
TA-25	25	160	25	52	26	M12	132	88	0.44
TA-30	30	180	25	58	29	M12	150	96	0.56
TA-40	40	230	30	72	36	M16	190	122	1.00

*To be used when linear glide carriage is mounted and shaft is driven

TAF Shaft End Support, Fixed*, mm



Special Properties

- Material: aluminum
- Plain bore

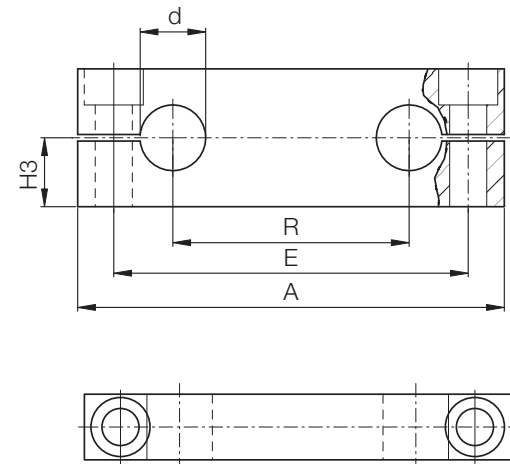
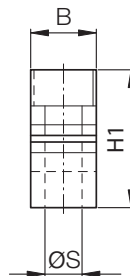

Dimensions (mm)

Part No.	d	A	B	H1	H3 ±0.015	R	S	E	Weight (kg)
TAF-08	8	65	12	23	12.5	32	5.5	52	0.04
TAF-12	12	85	14	32	18.0	42	6.6	70	0.09
TAF-16	16	100	18	36	20.0	54	9.0	82	0.14
TAF-20	20	130	20	46	25.0	72	11.0	108	0.25
TAF-25	25	160	25	56	30.0	88	13.5	132	0.47
TAF-30	30	180	25	64	35.0	96	13.5	150	0.62
TAF-40	40	230	30	80	44.0	122	17.5	190	1.15

*To be used when shaft is stationary and the carriage is driven

Internet: <http://www.igus.com>
email: sales@igus.com
QuickSpec: <http://www.igus.com/iglide-quickspec>

DryLin® Analysis Worksheet



Online Lifetime
Calculation
www.igus.com



Please enter as much data as possible.
Most applications questions can be answered with just a partial amount of data.
Please call us if you have any questions (Tel: 1-888-803-1895).
You may fax this worksheet to 401-438-7680

Application:

Current guide system:

Installation position (1=horizontal, 2=vertical, 3=lateral):

Number of bearings per rail/shaft: Number of rails/shafts:

Type of drive: Drive force [lbs]:

Average speed: Maximum speed:

Length of stroke: Expected service life:

Operating time:

Ambient temperature Maximum temperature:

Surrounding medium: Lubrication:

Static Load: Dynamic Load:

For the following data, the drawings on the reverse side will help you!

Distance between bearings/carriages on a rail/shaft (wx) :

Distance between rails/shafts (b) :

Distance of the mass force in the x-direction (Sx) :

Distance of the mass force in the y-direction (Sy) :

Distance of the mass force in the z-direction (Sz) :

Distance of the drive force in the y-direction (ay) :

Distance of the drive force in the z-direction (az) :

Please enter all the data you know and if possible make a schematic drawing.

Horizontal Orientation

Vertical Orientation

Lateral Orientation

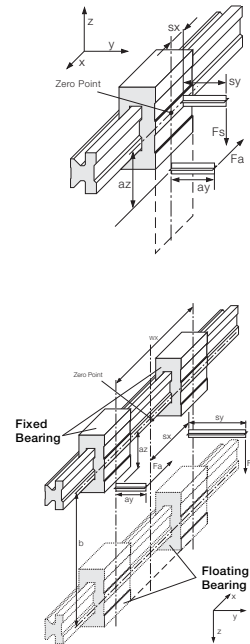
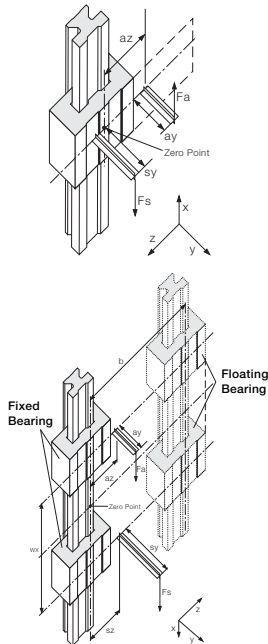
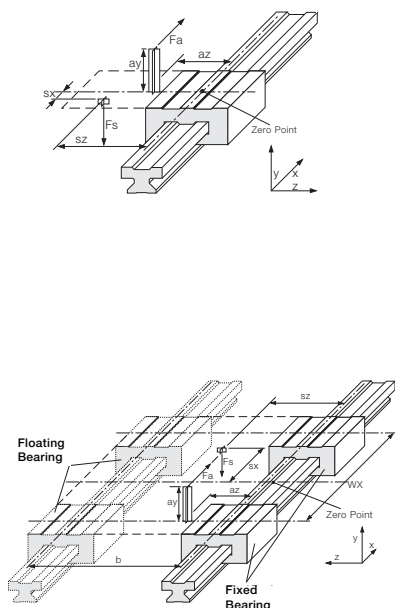

PDF: www.igus.com/iglide-pdfs
CAD: www.igus.com/iglide-CAD
RoHS info: www.igus.com/RoHS



inch

mm

DryLin® R
Linear Guide Systems



igus®

Telephone 1-800-521-2747
Fax 1-401-438-7270

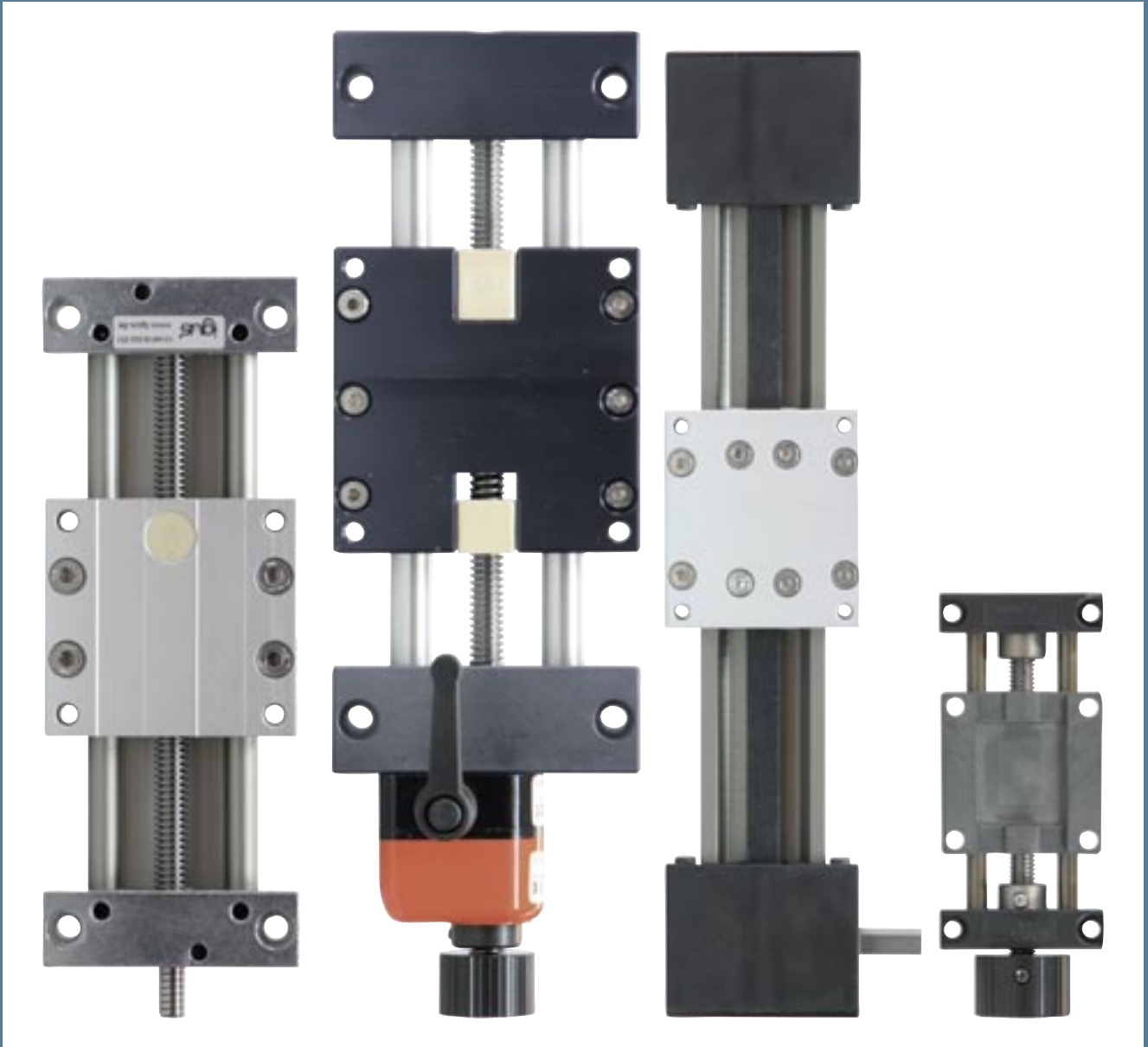

Internet: <http://www.igus.com>
email: sales@igus.com
QuickSpec: <http://www.igus.com/iglide-quickspec>

DryLin® R
Linear Guide Systems

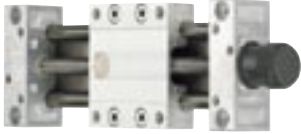
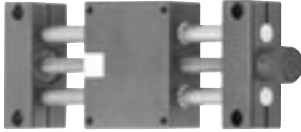

DryLin[®] Linear Drive Technology

DryLin® Slide Table Selection Guide

		Features	Options
	SLW	Cost + Performance Fully supported for rigidity	(SLWE-PL) Preloaded with adjustable clearance
	HTS(C)	Flexible Many shaft/screw options	(HTS-PL) Preloaded and adjustable clearance (HTSC) Compact carriage
	HTSP	Plastic blocks Lightweight Corrosion-resistant	Many shaft/screw combinations
	SET Easy Tube	For simple positioning	Locking carriage integrated scale
	ZLW Belt Drive System	For high-speed/low load applications Maintenance-free	Motor mounts Motor couplings

Accessories
Available



Position Indicator



Rotary Knob
Hand Wheel

Lead Screw and Nut Type		XY Available	Specialty Tables
Low-Speed Positioning	Hi-Speed		
SLW(ES) - Metric and trapezoidal	(SLWS) Hi-Helix Lead Screw (SLW-BB) up to 1500 rpm	Yes	SLW-1040-ES Stainless Steel
Trapezoidal lead screws	(HTSS) Hi-Helix Lead Screw (HTSCS) Hi-Helix Lead Screw	Yes	HTS-HTX High Temperature to 356°F HTS-HYD Stainless Hygienic Design HTS-FF Quick adjust then fine tune
Metric and trapezoidal lead screws	Hand-powered only	No	HTSP-FF Quick adjust then fine tune
Metric and trapezoidal lead screws	Hand-powered only	No	—
Belt driven up to 5 m/s possible	Belt-driven up to 5 m/s possible	No	—



V-Drive



Motor Flange



Coupling



Belt Drive Motor Flange



Threaded nuts are available as separate parts. Please see Section 26 for more information.

HTs and SLWE-XY in a camera/laser adjustment inspection application



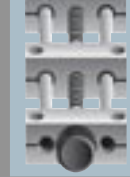

MILLING HEAD POSITIONING

The lack of oil means aluminum chips and dust cannot contaminate the bearing system



HEIGHT ADJUSTMENT OF CODING DEVICE

The DryLin® HTS lead screw unit gives variable and precise adjustment, free from any maintenance or lubrication.

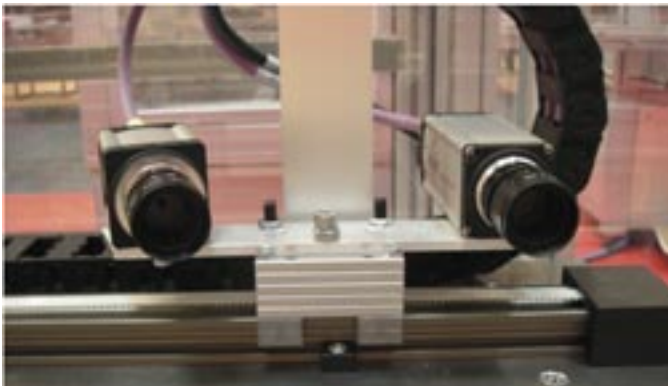

CAMERA ADJUSTMENT

The DryLin® ZLW belt drive gives quiet, smooth, and lubrication-free operation for this adjustable camera mount on a conveyor system.



CUT OFF SAW

Lead screw table used for fine adjustment on aluminum cut-off saw



ADJUSTMENT OF INSPECTION CAMERA

DryLin® ZLW toothed belt axis in an inspection camera adjustment, used for checking the position of seals.



WEB EDGE DETECTION

The DryLin® SLW lead screw unit with position indicator and hand wheel adjusts the sensors which detect the edge of the webbing and print marks on this packaging machine.



DryLin® Linear Slide Table

DryLin Slide Tables vs. In-House Production

DryLin®
Linear Slide Tables

Telephone 1-800-521-2747
Fax 1-401-438-7270

Internet: <http://www.igus.com>
email: sales@igus.com
QuickSpec: <http://www.igus.com/iglide-quickspec>

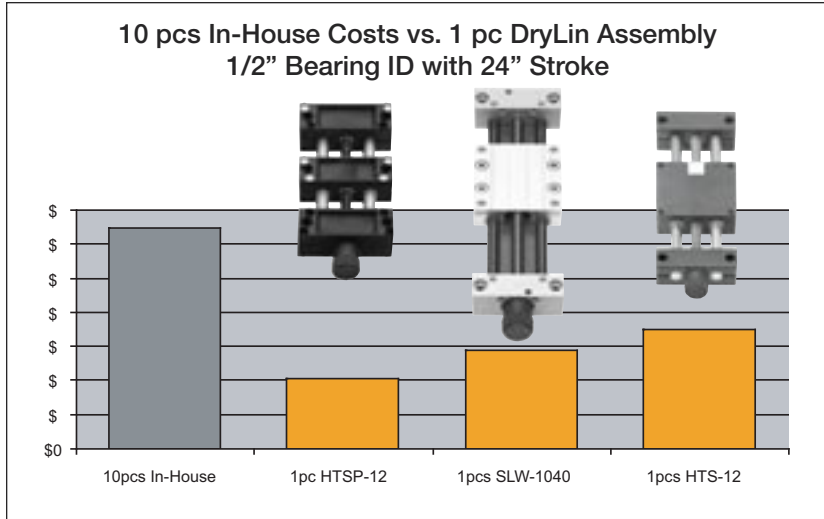

Reduce engineering/manufacturing time and costs

- Save on engineering costs
- Eliminate researching catalogs or internet
- Eliminate drawing or work instructions for assembly
- Eliminate checking specifications of lead screws, shafting, blocks, acme nuts and bearings
- Eliminate waiting for quotes/samples/phone calls from suppliers
- Eliminate designing fabricated parts
- Able to spend time on other aspects of design

Reduce purchasing costs

- More cost-efficient to place order using one Purchase Order rather than ten
- Save hidden costs of: Processing, expediting late parts, freight, potential returns/claims, downtime
- Spend time reducing other machine costs

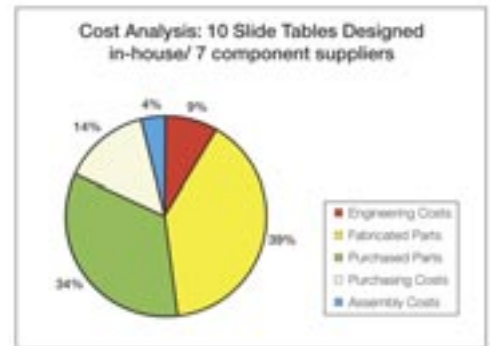

OPTIONS:

CUSTOM MACHINING CAPABILITY

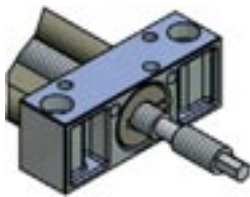

SELF-CENTERING (left/right) Tables available



CUSTOM PLATE CAPABILITY



RADIAL CLEARANCE ADJUSTMENT



RADIAL CLEARANCE ADJUSTMENT

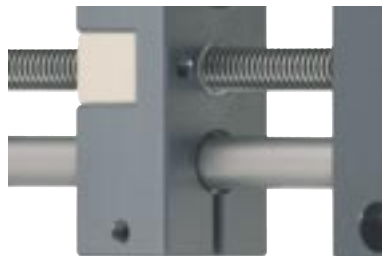

AXIAL PRELOAD



DryLin® Linear Slide Table Introduction

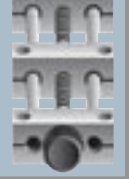

At iglus® we manufacture plastic bearings with the fundamental belief that they can help machinery last longer, at a lower cost, without the need for maintenance. DryLin® linear slide tables are the latest evolution of over 40-years of testing and development of plastic bearing materials. After noticing that many of our customers were fabricating their own linear systems with belts or lead screws, with parts from multiple suppliers, we designed our own.

You can of course piece together your own lead screw driven assembly – but why?

After you factor in the research, design, drawing, purchasing, QC, and assembly, you could have purchased a finished DryLin® unit from stock and designed several other aspects of your equipment – saving time and hidden costs.

- Off-the-shelf, ready to ship assemblies in stock
- Cut-to-order lengths can ship in less than 1-2 days
- Custom machining possible
- Downloadable CAD
- One part number; one purchase order; one supplier



DryLin®
Linear Slide Tables

Lead Screw Assemblies



SLW: Great blend of performance and value

- Hi helix available for high rpm
- Ball bearing (axial) version available for high rpm
- All stainless version available (SLW-1040 only)

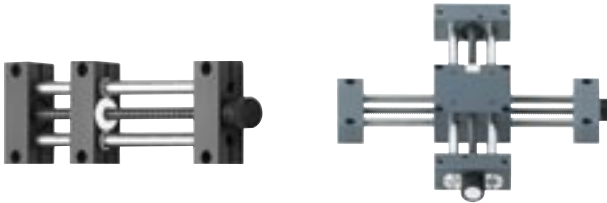

HTS(C): Our most flexible system, available in a variety of materials and configurations

- Hi helix available for high rpm
- All stainless hygienic version available
- Hi-temp to 356°F available



Easy Tube: Simple design for low-cost positioning

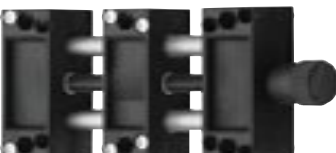

HTSP: All-plastic table with aluminum or stainless shafting for low cost and corrosion resistance

Belt-Drive Assemblies



ZLW-1040 basic/standard configurations

For fast positioning of small loads, cost-effective vs. ball bearing systems



ZLW-0630 basic/standard miniature slide

High performance for small spaces
.5" (31mm) height x 2.1" (54mm) width



ZAW-1040 cantilever axis

Lightweight and ideal for applications where you want the rail to move, and the carriage static, such as Z-axis applications



ZLW-1040-OD: Opposite drive

2 carriage opposite drive for bi-directional movement

PDF: www.igus.com/iglide-pdfs
CAD: www.igus.com/iglide-CAD
RoHS info: www.igus.com/RoHS





DryLin® Linear Slide Table Advanced Plastic Lead Screw Assemblies

DryLin®
Linear Slide Tables

Telephone 1-800-521-2747
Fax 1-401-438-7270

Internet: <http://www.igus.com>
email: sales@igus.com
QuickSpec: <http://www.igus.com/iglide-quickspec>



Tech support available at:
1-888-803-1895 or www.igus.com

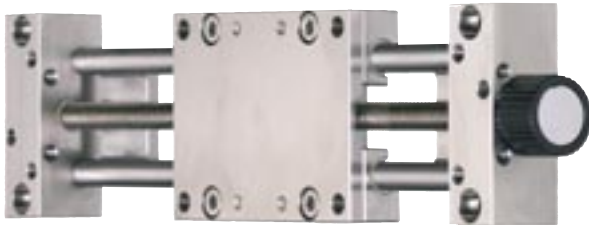

igus lead screw nuts were developed specifically to be bearing surfaces. The wear is much lower than simple plastics, and they do not require wet lubrication like bronze or other metallic nuts. The lead screws are available in either mild or stainless steel.

- Better wear resistance than other plastics
- Constant coefficient of friction
- Downloadable CAD
- No oil/maintenance like bronze or brass
- Anti-backdriving/self-locking
- Quiet operation
- Work well in aggressive environments
- Custom machining available
- Anti-backlash and adjustable clearance optional

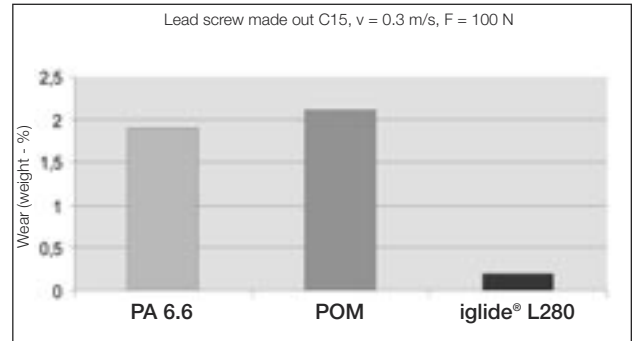

Wear of iglide® vs. simple plastic lead screw nuts 22.5 lb axial load, rotating at 1 fps on cold-rolled steel



Format adjustment using DryLin® Easy Tube

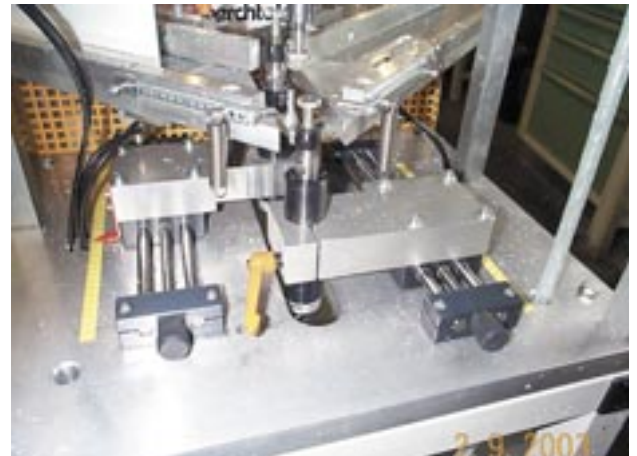

Lead screw table used to position milling heads in aluminum window manufacturing

DryLin® Linear Slide Tables

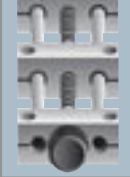

DryLin® linear lead screw units have been developed for position settings of all types. The linear setting is achieved by means of lead screw that can be operated manually or by low speed motor. The maximum linear continuous speed is 5.25 ft/min (1.6 m/min.) Use the graphs below to check suitability.

The following trapezoidal lead screw drive sizes are used in DryLin® linear tables:

- TR 10x2: HTS-12, HTSC-12, HTSP-12*, SLW-1040, SLW-1040-ES, SET-25
- TR 14x4: SLW-1660
- TR 18x4: HTS-20, HTS-20, SLW-2080
- TR 24x5: HTS-30, HTS-30

Please note that the loads given are axial loads. Radial loads are not given for trapezoidal lead screws.

*HTSP-12, max lbf - 45 lbs

For horizontal (radial load) applications with centric loads, use the following formula to determine the axial load

$$F_{axial} = F_{radial} \times 0.25$$



DryLin®
Linear Slide Tables

PDF: www.igus.com/iglide-pdfs
CAD: www.igus.com/iglide-CAD
RoHS info: www.igus.com/RoHS



Maximum Feed (fpm)

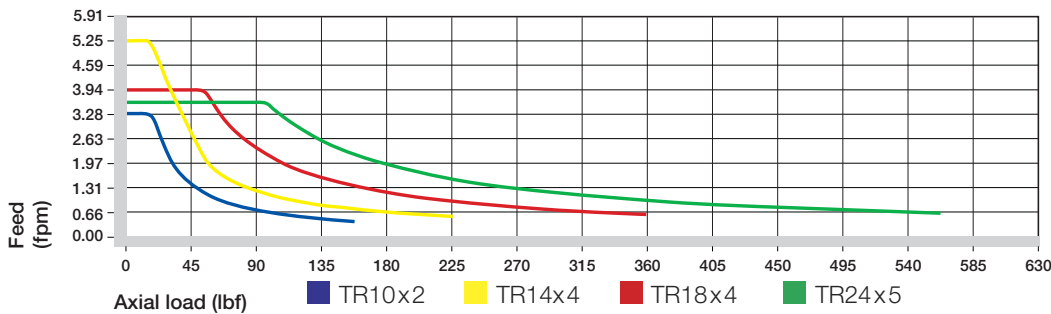

For higher speed applications hi-helix series SLWS, SLW-BB, HTSS or ZLW belt drives

Maximum permissible rotation speed leadscrew (rpm)

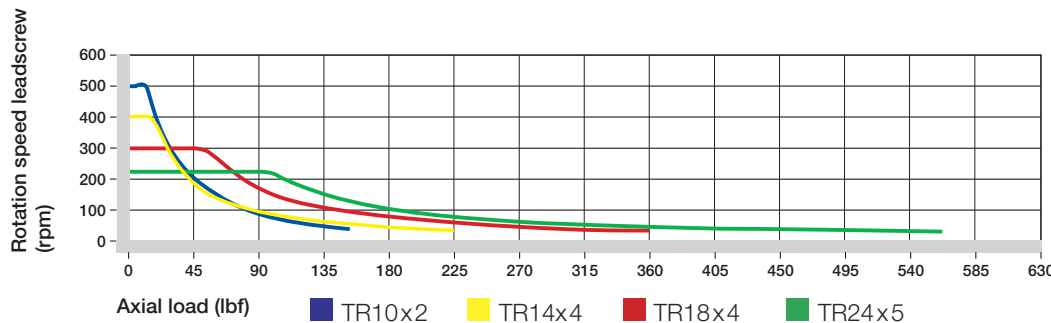

Drive Torque (lbf · ft)

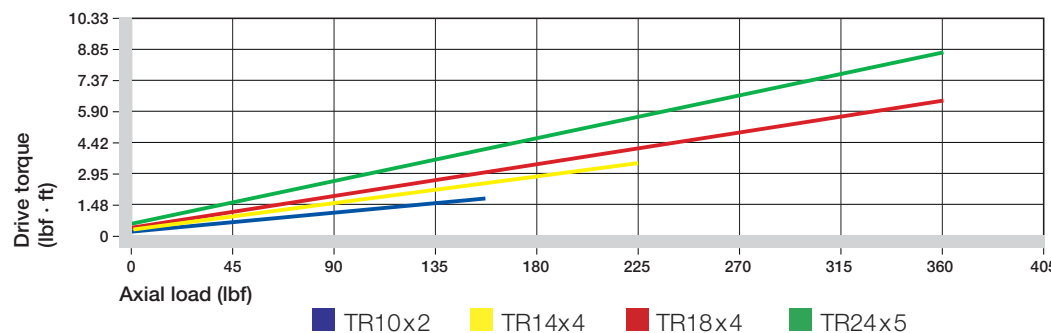

DryLin® Linear Slide Table - SLW Slide Table System

A good blend of performance and cost



Based on our innovative DryLin® W double rail system, the SLW offers a fully supported rail with resistance to twisting and deflection. SLW also offers a lower profile than most other lead screw tables and runs absolutely maintenance-free.

Component Materials

Part No.	End blocks	Carriages	Lead screw
SLW-0630	Plastic	Zinc	Stainless Steel
SLW-1040-PL	Zinc*	Zinc	Mild Steel**
SLW-1040-ES	Stainless Steel	Stainless Steel	Stainless Steel
SLW-1040-BB	Anodized AL	Zinc*	Mild Steel
SLW-1080	Anodized AL	Zinc*	Mild Steel**
SLW-1660	Anodized AL	Zinc*	Mild Steel**
SLW-2080	Anodized AL	Zinc*	Mild Steel**

*Aluminum optional **Stainless Steel optional

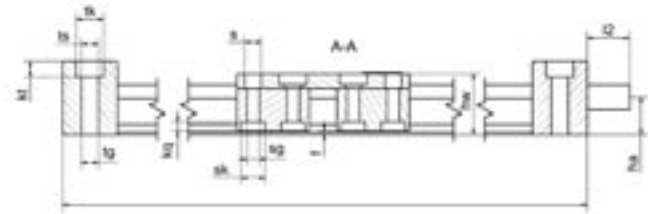
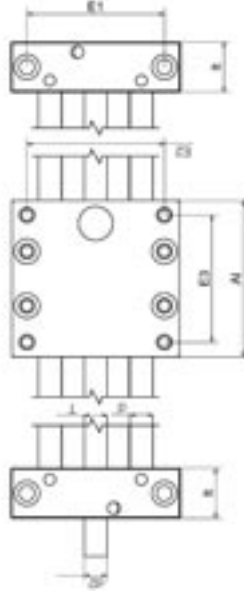

Can be assembled with Turn-To-Fit
For clearance adjustment see page 27.13

- Hand wheel option

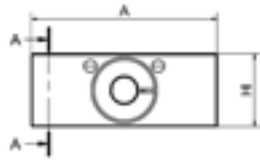

Length and weight (mm)

Part No.	Maximum stroke length (mm)	Linear travel mm/rev	Shaft weight (kg)	Additional weight (kg/100mm)	Max. static load-bearing capacity	
					axial (N)	radial (N)
SLW-0630	300	1.25	0.2	0.08	50	200
SLW-1040	750	2	0.7	0.1	700	2800
SLW-1080	750	2	0.9	0.2	700	2800
SLW-1660	1000	4	1.5	0.3	1200	4600
SLW-2080	1000	5	3.0	0.4	1600	6400

(1N = .225 lbs)

Dimensions (mm)

Part No.	A	Al**	H	E1	E2	E3	l	hw	f	lt	tk	ts	tg
	-0.3	-0.3		±0.15	±0.15	±0.15				-0.1			
SLW-0630	54	60	20	40	45	51	100	17.5	1.2	20	11	6.2	-
SLW-1040	74	69	29	60	60	56	113	24	1.5	22	11	6.8	M8
SLW-1080	108	100	29	94	94	87	144	24	1.5	22	11	7.1	M8
SLW-1660	104	100	37	84	86	82	150	35	1.5	25	15	9.0	M10
SLW-2080	134	150	46	116	116	132	206	44	1.5	28	15	8.6	M10

Part No.	kt ±0.1	s	sk	sg	kq	d	T	l2	d2 Standard	d2 Optional	ha
SLW-0630	8.0	4.5	7.0	M4	2.0	6	M8	15	M8	-	9.5
SLW-1040	6.4	6.6	9.5	M6	4.4	10	TR10x2	17	TR10x2*	6h9	14.5
SLW-1080	6.4	6.6	9.5	M6	4.4	10	TR10x2	17	TR10x2*	6h9	14.5
SLW-1660	8.6	9.0	11	M8	5.5	16	TR14x4	20	TR14x4*	8h9	18.5
SLW-2080	8.6	9.0	14.0	M8	5.5	20	TR18x4	26	12 h9	-	23.0

* end of lead screw not machined/jouaned

** Carriages also available in 100, 150, 200 and 250 mm lengths

DryLin®
Linear Slide Tables

Telephone 1-800-521-2747
Fax 1-401-438-7270

Internet: <http://www.igus.com>
email: sales@igus.com
QuickSpec: <http://www.igus.com/iglide-quickspec>

DryLin® Linear Slide Table SLWS - Hi-helix Lead Screw Tables

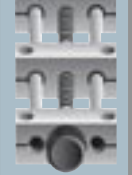

DryLin®
Linear Slide Tables

Based on our innovative DryLin® W double rail system, the SLWS offers a fully supported rail with resistance to twisting and deflection.

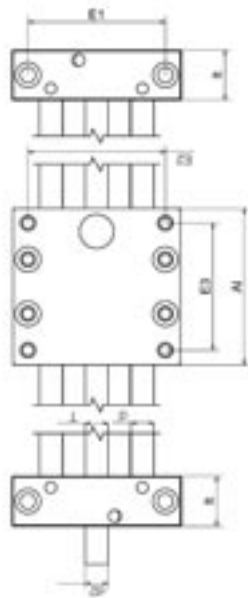

Component Materials

Part No.	End blocks	Carriages	Lead screw
SLWS-0630	Plastic	Zinc*	Stainless Steel
SLWS-1040	Zinc*	Zinc*	Stainless Steel
SLWS-1080	Aluminum	Zinc*	Stainless Steel
SLWS-2080	Aluminum	Zinc*	Stainless Steel

*Aluminum optional

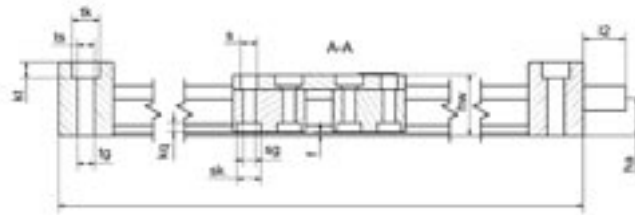

Can be assembled with Turn-To-Fit
For clearance adjustment see page 27.13

- Hand wheel option

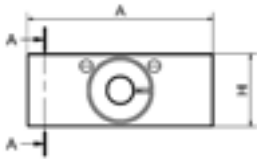

Length and weight (mm)

Part No.	Maximum stroke length (mm)	Linear travel mm/rev	Shaft weight (kg)	Additional weight (kg/100mm)	Max. static load-bearing capacity	
					axial (N)	radial (N)
SLWS-0630	300	15	0.2	0.08	25	100
SLWS-1040	750	12/50	0.7	0.1	150/100 ¹⁾	600/400
SLWS-1080	750	12/50	0.9	0.2	150/100	600/400
SLWS-2080	1000	100	3.0	0.4	300	1200

¹⁾ Dependent on screw pitch 10x12 or 10x50
(1N = .225 lbs)

Dimensions (mm)

Part No.	A	Al**	H	E1	E2	E3	I	hw	f	lt	tk	ts	tg
	-0.3	-0.3		±0.15	±0.15	±0.15				-0.1			
SLWS-0630	54	60	20	40	45	51	100	17.5	1.2	20	11	6.2	-
SLWS-1040	74	69	29	60	60	56	113	24	1.5	22	11	6.8	M8
SLWS-1080	108	100	29	94	94	87	144	24	1.5	22	11	7.1	M8
SLWS-2080	134	150	46	116	116	132	206	44	1.5	28	15	8.6	M10

Part No.	kt ±0.1	s	sk	sg	kq	d	T	l2	d2 Standard	d2 Optional	ha
SLWS-0630	8.0	4.5	7.0	M4	2.0	6	8x15	15	8x15	-	9.5
SLWS-1040	6.4	6.6	9.5	M6	4.4	10	10x12/10x50	17	10x12/10x50	6h9	14.5
SLWS-1080	6.4	6.6	9.5	M6	4.4	10	10x12/10x50	17	10x12/10x50	6h9	18.5
SLWS-2080	8.6	9.0	14.0	M8	5.5	20	18x100	26	12 h9	-	23.0

* end of lead screw not machined/jouaned

** Carriages also available in 100, 150, 200 and 250 mm lengths

PDF: www.igus.com/iglide-pdfs
CAD: www.igus.com/iglide-CAD
RoHS info: www.igus.com/RoHS





DryLin® Linear Slide Table - HTS SLWE-PL Preload

DryLin®
Linear Slide Tables

Telephone 1-800-521-2747
Fax 1-401-438-7270

Internet: <http://www.igus.com>
email: sales@igus.com
QuickSpec: <http://www.igus.com/iglide-quickspec>



• Hand wheel option available at additional cost

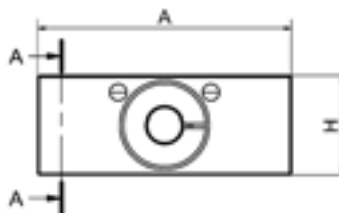

The new preload version DryLin® SLWE-PL linear slide table offers an additional benefit to the standard systems. In the preloaded version the axial clearance is adjusted by two trapezoidal nuts. The carriage can be adjusted manually by a set screw.

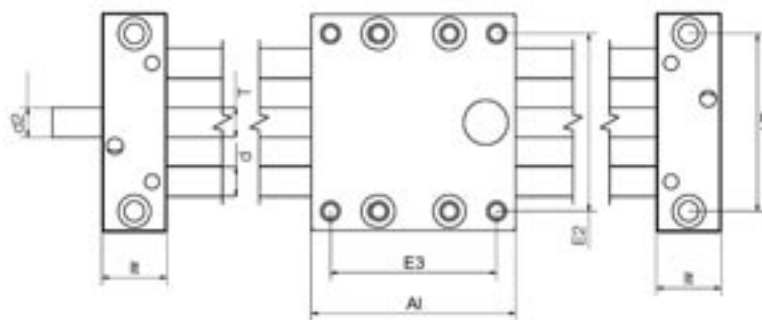
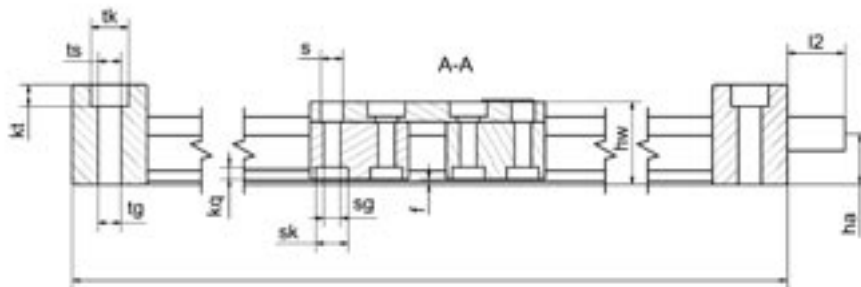

Length and weight (mm)

Part No.	Maximum stroke length (mm)	Linear travel mm/rev	Shaft weight (kg)	Additional weight (kg/100mm)	Max. static load-bearing capacity	
					axial (N)	radial (N)
SLWE-1040	750	2	0.7	0.1	700	2800
SLWE-1080	750	2	0.9	0.2	700	2800
SLWE-1660	1000	4	1.5	0.3	1200	4600
SLWE-2080	1000	5	3.0	0.4	1600	6400

Dimensions (mm)

Part No.	A	Al**	H	E1	E2	E3	I	hw	f	lt	tk	ts	tg
	-0.3	-0.3		±0.15	±0.15	±0.15				-0.1			
SLWE-1040	74	69	29	60	60	56	113	24	1.5	22	11	6.8	M8
SLWE-1080	108	100	29	94	94	87	144	24	1.5	22	11	7.1	M8
SLWE-1660	104	100	37	84	86	82	150	35	1.5	25	15	9.0	M10
SLWE-2080	134	150	46	116	116	132	206	44	1.5	28	15	8.6	M10

Part No.	kt	s	sk	sg	kq	d	T	l2	d2	d2	ha
	±0.1								Standard	Optional	
SLWE-1040	6.4	6.6	9.5	M6	4.4	10	TR10x2	17	TR10x2*	6h9	14.5
SLWE-1080	6.4	6.6	9.5	M6	4.4	10	TR10x2	17	TR10x2*	6h9	14.5
SLWE-1660	8.6	9.0	11	M8	5.5	16	TR14x4	20	TR14x4*	8h9	18.5
SLWE-2080	8.6	9.0	14.0	M8	5.5	20	TR18x4	26	12 h9	-	23.0

* end of lead screw not machined/jouaned

** Carriages also available in 100, 150, 200 and 250 mm lengths

DryLin® Linear Slide Tables - HTS

SLWE-BB - With ball bearing lead screw supports

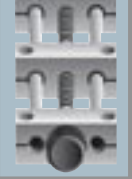

DryLin®
Linear Slide Tables

PDF: www.igus.com/iglide-pdfs
CAD: www.igus.com/iglide-CAD
RoHS info: www.igus.com/RoHS



DryLin® linear table with ball bearing lead screw supports. Linear guide and lead screw absolutely lubrication-free. Compact and low profile linear actuator for manual or motor drive and higher dynamics.

Special properties

- Lower drive force
- Optimized clearance
- Up to 1,500 rpm (depending on length and load)
- Quiet operation
- Available accessories

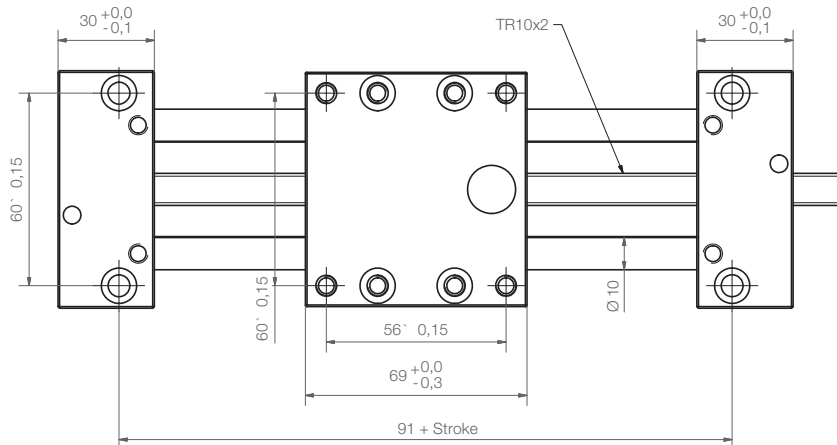
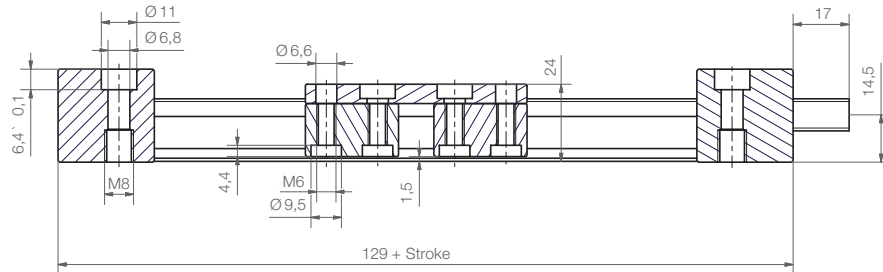
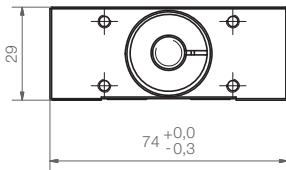

Length and weight (mm)

Part No.	Maximum stroke length (mm)	Linear travel mm/rev	Shaft weight (kg)	Additional weight (kg/100mm)	Max. static* load-bearing capacity	
					axial (N)	radial (N)
SLWE-1040-BB	750	2/12/50	0.7	0.1	*700/150/100	2800/600/400

*1 Dependent on screw pitch 10x2, 10x12 or 10x50

(1N = .225 lbs)



DryLin® Linear Slide Table -HTS SLW - Compact XY-table

DryLin®
Linear Slide Tables

Telephone 1-800-521-2747
Fax 1-401-438-7270

Internet: <http://www.igus.com>
email: sales@igus.com
QuickSpec: <http://www.igus.com/iglide-quickspec>

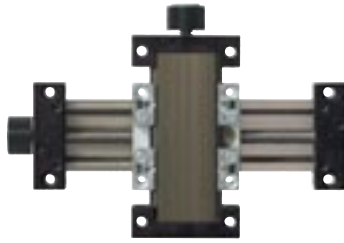

SLW-XY-0630

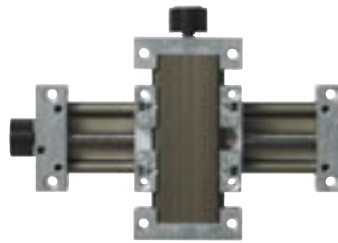

SLW-XY-1040



SLW-XY-1080

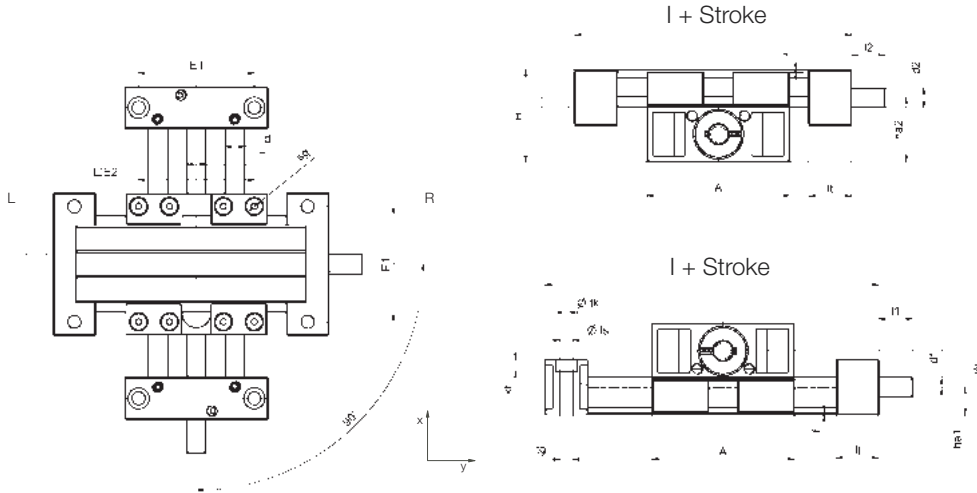

Can be assembled with Turn-To-Fit for clearance adjustment (size 1040 only)

Component Materials

Part No.	End blocks	Carriages	Lead screw	Maximum stroke
SLW-0630-XY	Plastic	Zinc*	Stainless Steel	300
SLW-1040-XY	Zinc*	Zinc*	Mild Steel**	750
SLW-1080-XY	Aluminum	Zinc*	Mild Steel**	750

*Aluminum optional **Stainless Steel optional

Dimensions (mm)

Part No.	Linear travel/rev (mm)	A (mm)	H (mm)	E1 (mm)	E2 (mm)	Basic length lx (mm)	Basic length ly (mm)	f (mm)	lt (mm)	tk (mm)	ts (mm)	tg	kt (mm)
SLW-XY-0630	1.25	54	37.4	40	45	100	100	1.2	20	11	8	-	8
SLW-XY-1040	2	74	48	60	60	117	117	1.5	22	11	6.6	M8	6.4
SLW-XY-1080	108	48	94	94	152	152	105	1.5	22	11	6.6	M8	6.4

Part No.	sg	d (mm)	T	l1 (mm)	d1 standard	d1 optional	l2 (mm)	d2 standard	d2 optional	ha1 (mm)	ha2 (mm)	W (mm)
SLW-XY-0630	M4	5	M8	15	M8	NA	15	M8	NA	9.5	27.9	18.4
SLW-XY-1040	M6	10	TR10x2	17	TR10x2	6h9	17	TR10x2	6h9	18	38	20
SLW-XY-1080	M6	10	TR10x2	17	TR10x2	6h9	17	TR10x2	6h9	14.5	33.5	19

The hand wheel on the y-axis can be ordered installed on the left or the right side.

Order example for left SLW-XY-1040-L-200-300 for 200 mm stroke length on the x-axis and 300 mm on the y-axis.

Order example for right SLW-XY-1040-R-200-300 for 200 mm stroke length on the x-axis and 300 mm on the y-axis.

Lifetime calculation, CAD files online: www.igus.com

DryLin® Linear Slide Tables - HTS SLW-ES - Stainless Steel

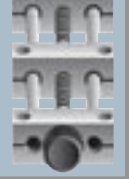

Special properties

- Stainless steel version with corrosion-resistant steel components
- Choice of bearing material:
 - iglide® J - standard
 - iglide® A180 - FDA
 - iglide® T500 - high temperature up to 482°F
- Available accessories

DryLin®
Linear Slide Tables

PDF: www.igus.com/iglide-pdfs
CAD: www.igus.com/iglide-CAD
RoHS info: www.igus.com/RoHS

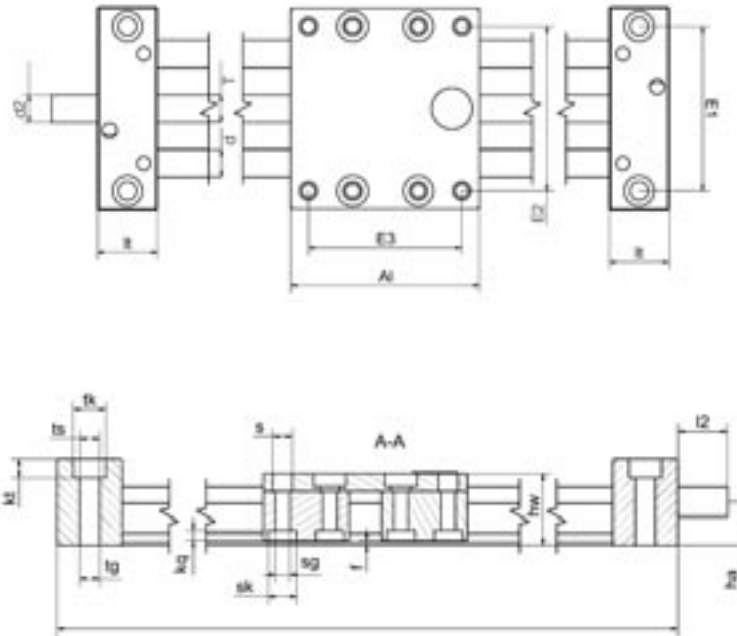
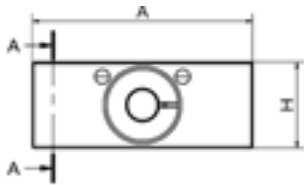

Can be assembled with Turn-To-Fit
For clearance adjustment see page 27.13

Dimensions (mm)

Part No.	A	A1**	H	E1	E2	E3	l	hw	f	lt	tk	ts	tg
	-0.3	-0.3		±0.15	±0.15	±0.15				-0.1			
SLW-ES-1040	74	100	29	60	60	87	113	24	1.5	22	11	6.8	M8
SLW-ES-2080	134	150	46	116	116	132	206	44	1.5	28	15	8.0	M10

Part No.	kt	s	sk	sg	kq	d	T	l2	d2	d2	ha
	±0.1								Standard	Optional	
SLW-ES-1040	6.4	6.6	9.5	M6	4.4	10	TR10x2	17	TR10x2*	6h9	14.5
SLW-ES-2080	8.6	9.0	14.0	M8	5.5	20	TR18x4	26	12 h9	-	23.0

* end of lead screw not machined/jourealed

** Carriages also available in 100, 150, 200 and 250 mm lengths

Length and weight (mm)

Part No.	Maximum stroke length	Linear travel/rev	Lead screw diameter	Shaft weight	Additional weight	Max. static load-bearing capacity	
	(mm)					(mm)	(mm)
SLW-ESJ-1040	750	1.25	10	0.2	0.08	50	200
SLW-ESX-1040	750	2	10	0.7	0.1	700	2800
SLW-ESA180-1040	750	2	10	0.9	0.2	700	2800
SLW-ESJ-2080	1000	4	18	1.5	0.3	1200	4600
SLW-ESA180-2080	1000	5	18	3.0	0.4	1600	6400

1N = .225 lbs





DryLin® Linear Slide Tables

SLW - Compact XY-table, stainless steel

DryLin®
Linear Slide Tables

Telephone 1-800-521-2747
Fax 1-401-438-7270

Internet: <http://www.igus.com>
email: sales@igus.com
QuickSpec: <http://www.igus.com/iglide-quickspec>



Special properties

- For manual adjustments
- Flat and compact
- High torsional stability stiffness
- Complete design with stainless steel 316
- 100% lubrication-free
- Chemical and Corrosion-resistant
- Accessories optional

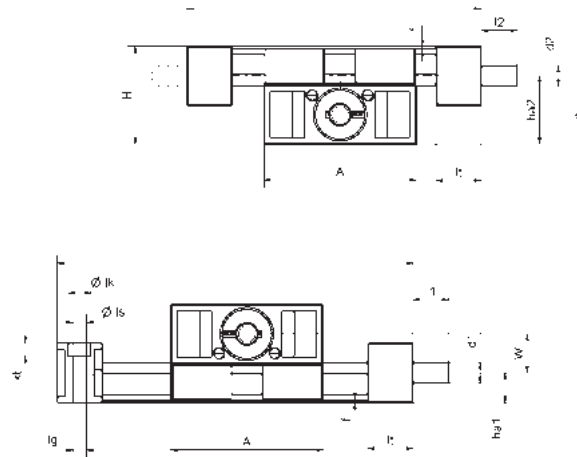
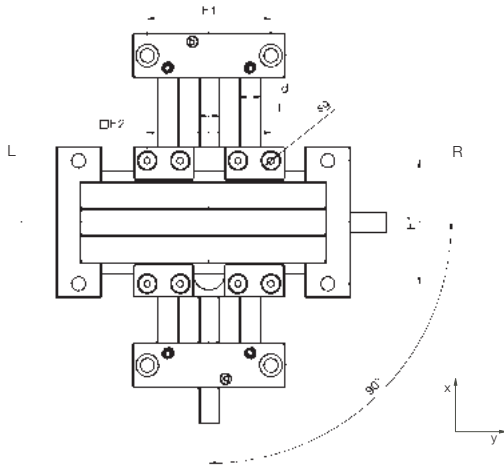

Dimensions (mm)

Part No.	A	H	E1	E2	Base Length lx	Base Length ly	f	lt	tk	ts	tg	kt
SLW-XY-ESJ-1040	-0.3 74	48	±0.15 60	±0.15 60	118	118	1.5	22	-0.1 11	6.6	M8	6.4

Part No.	sg	d	T	l1	d1 Standard	d1 Optional	l2	d2 Standard	d2 Optional	ha1	ha2	W
SLW-XY-ESJ-1040	M6	10	TR10x2	17	TR10x2	6h9	17	TR10x2	6h9	14.5	33.5	19

The hand wheel on the y-axis can be ordered installed on the left or the right side.

Order example for left SLW-XY-ESJ-1040-AWM-200-300 for 200 mm stroke length on the x-axis and 300 mm on the y-axis.

Order example for left SLW-XY-ESJ-1040-AWM-R-200-300 for 200 mm stroke length on the x-axis and 300 mm on the y-axis.

DryLin® Linear Slide Tables

HTS Slide Table System

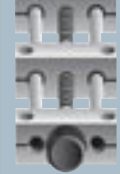

Tough and adaptable, HTS is the most flexible system and is available with several shaft and screw combinations, including hard anodized aluminum and stainless steel. All HTS tables are designed to be simple bolt-on solutions. HTSC offers a compact(act carriage).

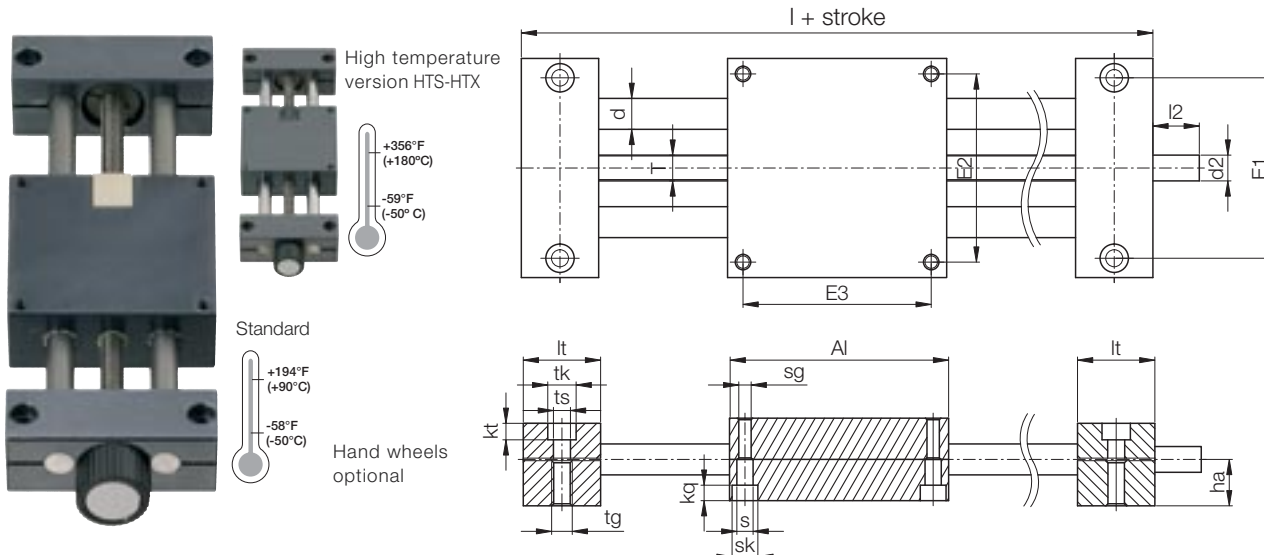

Component Materials

Part No.	Shafting	End blocks/Carriages	Bearings	Lead screw
HTS	Hard Anodized AL*	Anodized AL	iglide® plastic	Mild Steel**
HTS-HTX	Stainless 440C	Anodized AL	iglide® plastic	Stainless 304

*Case hardened carbon (1050) & Hardened stainless (440C) optional

**Stainless (304SS) optional

Length (mm) and Weight

Part No.	Maximum stroke length (mm)	Linear travel/rev (mm)	Aluminum Shaft		Steel Shaft		Max. static load-bearing capacity	
			weight (kg)	add'l weight (per 100 mm) (kg)	weight (kg)	add'l weight (per 100 mm) (kg)	axial (N)	radial (N)
HTS-12-AWM	750	2	1.1	0.1	1.3	0.2	700	2800
HTS-20-AWM	1000	4	3.2	0.3	3.9	0.6	1600	6400
HTS-30-AWM	1250	5	8.6	0.6	10.9	1.4	2500	10000

Hi Temperature (-59°F - 356°F)

HTS-12-EWM-HTX**	750	2	1.1	0.1	1.3	0.2	700	2800
------------------	-----	---	-----	-----	-----	-----	-----	------

(1N = .225 lbs)

Dimensions (mm)

Part No.	A	Al	H	E1	E2	E3	I	R	f	l _t	t _k	t _s
	-0.3	-0.3		±0.15	±0.15	±0.15				±0.1		
HTS-12-AWM	85	85	34	70	73	73	145	42	2	30	11	6.6
HTS-20-AWM	130	130	48	108	115	115	202	72	2	36	15	9.0
HTS-30-AWM	180	180	68	150	158	158	280	96	4	50	20	13.5

Hi Temperature (-59°F - 356°F)

HTS-12-EWM-HTX**	85	85	34	70	73	73	145	42	2	30	11	6.6
------------------	----	----	----	----	----	----	-----	----	---	----	----	-----

Part No.	tg	kt	s	sk	sg	kq	d	T	l ₂	d ₂	h _a
		±0.1								Standard	
HTS-12-AWM	M8	6.4	6.3	10	M6	6.0	12	TR10 x 2	17	TR10 x 2*	18
HTS-20-AWM	M10	8.6	6.4	11	M8	7.0	20	TR18 x 4	26	12 h9	23
HTS-30-AWM	M16	12.6	11.0	18	M12	10.6	30	TR24 x 5	38	14 h9	36

Hi Temperature (-59°F - 356°F)

HTS-12-EWM-HTX**	M8	6.4	6.3	10	M6	6.0	12	TR10 x 2	17	TR10 x 2*	18
------------------	----	-----	-----	----	----	-----	----	----------	----	-----------	----

* TR10x2 lead screw end unmachined (10 mm OD x 2 mm pitch), optional 6mm available

DryLin®
Linear Slide Tables

PDF: www.igus.com/iglide-pdfs
CAD: www.igus.com/iglide-CAD
RoHS info: www.igus.com/RoHS



DryLin® Linear Slide Table

HTS-PL Adjustable Clearance and Anti-Backlash



DryLin®
Linear Slide Tables

Telephone 1-800-521-2747
Fax 1-401-438-7270

Internet: <http://www.igus.com>
email: sales@igus.com
QuickSpec: <http://www.igus.com/iglide-quickspec>



Special properties

- Lubricant-free
- Preloaded trapezoidal lead screw nut, Pretension force 11.2 lbf (50 N)
- Radial clearance is adjustable from both sides
- Low weight

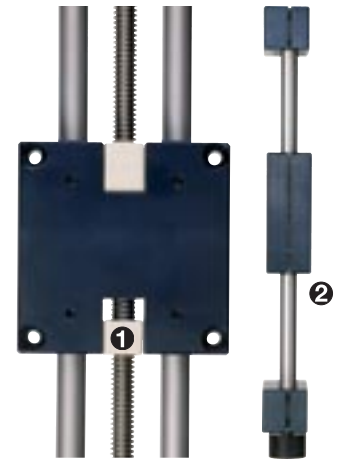
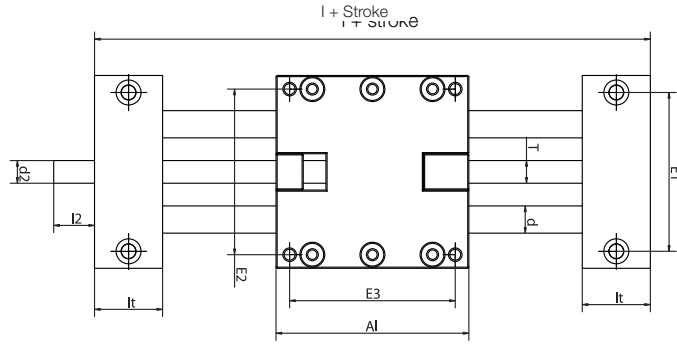

- 1 Preloaded trapezoidal lead screw nut
2 Radial clearance adjustable from both sides

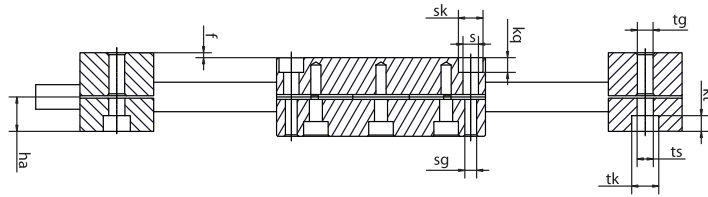
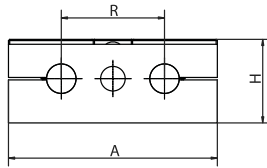

Component Materials

Part No. Shafting End blocks/Carriages Bearings Lead screw

HTS Hard Anodized AL* Anodized AL iglide® plastic Mild Steel**

*Case hardened carbon (1050) & Hardened stainless (440C) optional

**Stainless (304SS) optional

Length (mm) and Weight

Part No.	Maximum stroke length (mm)	Linear travel/rev (mm)	Aluminum shaft weight		Steel shaft weight		Max. static load-bearing capacity	
			weight (kg)	add 'l weight (per 100 mm) (kg)	weight (kg)	add 'l weight (per 100 mm) (kg)	axial (N)	radial (N)
HTS-12-AWM-PL	750	2	1.1	0.1	1.3	0.2	700	2800
HTS-20-AWM-PL	1000	4	3.2	0.3	3.9	0.6	1600	6400
HTS-30-AWM-PL	1250	5	8.6	0.6	10.9	1.4	2500	10000

(1N = .225 lbs)

Dimensions (mm)

Part No.	A	A1	H	E1	E2	E3	I	R	f	lt	tk	ts
	-0.3	-0.3		±0.15	±0.15	±0.15				±0.1		
HTS-12-AWM-PL	85	85	34	70	73	73	145	42	2	30	11	6.6
HTS-20-AWM-PL	130	130	48	108	115	115	202	72	2	36	15	9.0
HTS-30-AWM-PL	180	180	68	150	158	158	280	96	4	50	20	13.5

Part No.	tg	kt ±0.1	s	sk	sg	kq	d	T	l2	d2 Standard	ha
HTS-12-AWM-PL	M8	6.4	6.3	10	M6	6.0	12	TR10x2	17	TR10x2*	18
HTS-20-AWM-PL	M10	8.6	6.4	11	M8	7.0	20	TR18x4	26	12 h9	23
HTS-30-AWM-PL	M16	12.6	11.0	18	M12	10.6	30	TR24x5	38	14 h9	36

* TR10x2 lead screw end unmachined, optional 6mm available

DryLin® Linear Slide Table HTSS Fast Pitch Lead screws



Special properties

- High helix pitch lead screw
HTSS-12 moves 10x12/10x50
HTSS-20 moves 18x100
- High-speed solution
- Maintenance-free
- Dry running
- Hand wheel option

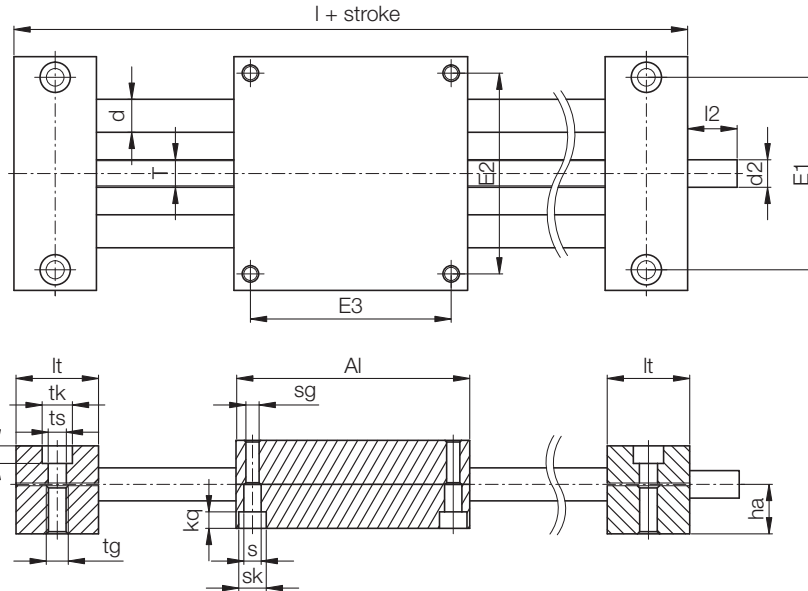

Component Materials

Part No.	Shafting	End blocks/Carriages	Bearings	Lead screw
HTSS	Hard Anodized AL*	Anodized AL	iglide® plastic	Stainless

*Case hardened carbon (1050) & Hardened stainless (440C) optional

Length (mm) and Weight

Part No.	Linear travel/rev (mm)	Maximum stroke length (mm)	Aluminum shaft		Max. static load-bearing capacity	
			weight (kg)	add'l weight (per 100 mm) (kg)	axial (N)	radial (N)
HTSS-12-AWM	12/50	750	0.7	0.1	150/100 ¹⁾	600/400
HTSS-20-AWM	100	1000	1.9	0.3	300	1200

¹⁾ Dependent on screw pitch 10x12 or 10x50

(1N = .225 lbs)

Dimensions (mm)

Part No.	A	Al	H	E1	E2	E3	l	R	f	lt	tk	ts	tg
	-0.3	-0.3		±0.15	±0.15	±0.15				±0.1			
HTSS-12-AWM	85	85	34	70	73	73	145	42	2	30	11	6.6	M8
HTSS-20-AWM	130	130	48	108	115	115	202	72	2	36	15	9.0	M10

Part No.	kt	s	sk	sg	kq	d	T	l2	d2	ha
	±0.1								Standard	
HTSS-12-AWM	6.4	6.3	10	M6	6.0	12	TR10x50	17	TR10x50*	18
HTSS-20-AWM	8.6	6.4	11	M8	7.0	20	TR18x100	26	12 h9	23

* TR10x50 supplied with lead screw end unmachined, optional 6mm available

Available lead screws: 10 mm OD w/ 50 mm pitch
18 mm OD w/100 mm pitch

Lifetime calculation, CAD files online: www.igus.com

DryLin®
Linear Slide Tables

PDF: www.igus.com/iglide-pdfs
CAD: www.igus.com/iglide-CAD
RoHS info: www.igus.com/RoHS



1





DryLin® Linear Slide Table - HTS

HTS-FF - Fast Forward

DryLin®
Linear Slide Tables

Telephone 1-800-521-2747
Fax 1-401-438-7270

Internet: <http://www.igus.com>
email: sales@igus.com
QuickSpec: <http://www.igus.com/iglide-quickspec>



HTS linear tables with quick release mechanism offer a combination of accurate positioning and quick manual adjustment.

Special properties

- Aluminum carriage and end blocks
- For fast format adjustments
- Variable stroke length
- Only recommended for horizontal applications
- Max. static axial load 200 N (horizontal installation position)
- Max. dynamic axial load 50 N
- Hand wheel optional

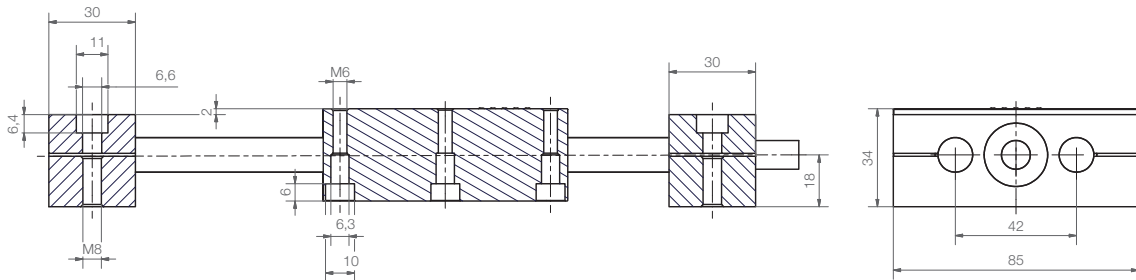
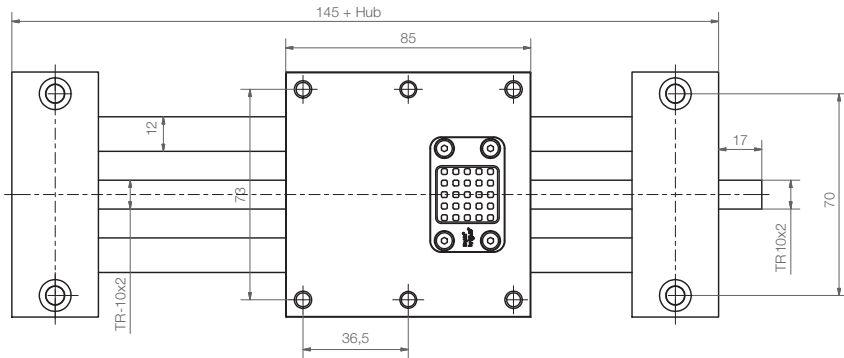

Part number	Max. length of stroke (mm)	Weight (kg)	Additional weight pro 100 mm
SHT-12-AWM-FF	750	1.1	0.1

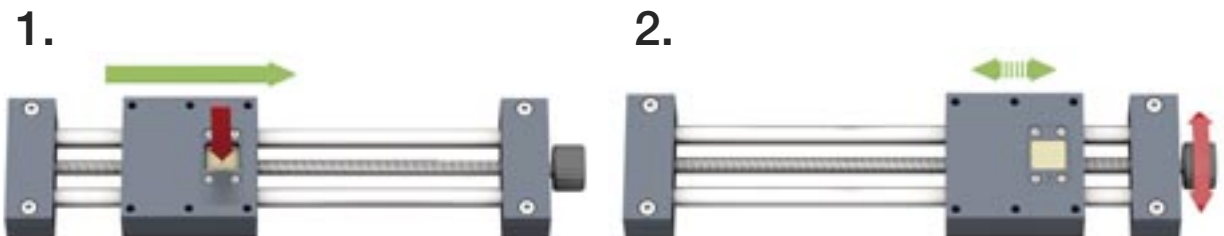

Press > disengage > move manually > click into place > fine-tune

DryLin® Linear Slide Table - HTS

HTS-PL XY Table

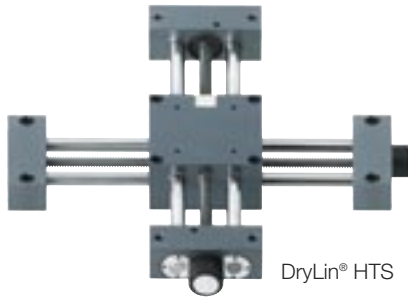
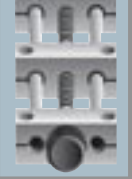

DryLin® HTS

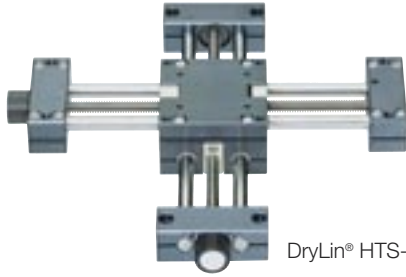

DryLin® HTS-PL

Special properties

- High precision, extreme stiffness and exact alignment, single piece carriage
- Available as standard and preloaded
- Hand wheel optional

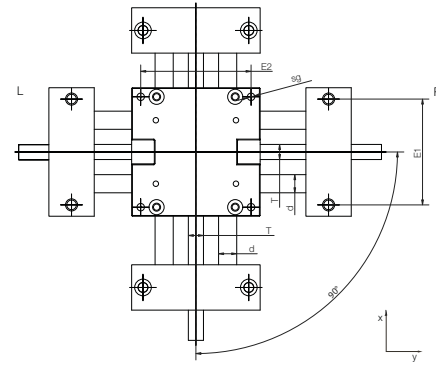
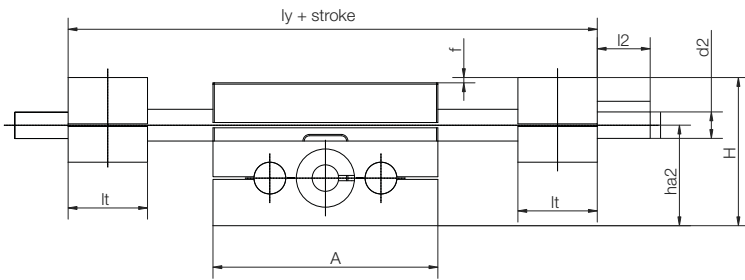
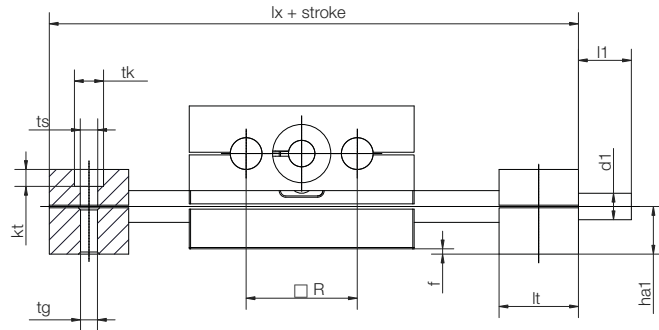

Component Materials

Part No.	Shafting	End blocks/Carriages	Bearings	Lead screw
HTS	Hard Anodized AL*	Anodized AL	iglide® plastic	Mild Steel**

*Case hardened carbon (1050) & Hardened stainless (440C) optional

**Stainless (304SS) optional

Length (mm) and Weight

Part No.	Linear travel/rev (mm)	A (mm)	H (mm)	E1 (mm) ±0.15	E2 (mm) ±0.15	Basic length lx (mm)	Basic length ly (mm)	R (mm)	f (mm)	lt (mm) ±0.1	tk (mm)	ts (mm)	tg (mm)	kt (mm)
HTS-XY-12	2	85	56	70	73	145	145	42	2	30	11	6.6	M8	6.4
HTS-XY-12-PL	2	85	56	70	73	145	145	42	2	30	11	6.6	M8	6.4
HTS-XY-20-EWM-PL	4	130	86	108	115	202	202	72	2	36	15	9.0	M10	8.6

Dimensions (mm)

Part No.	sg	d (mm)	T	l1 (mm)	d1 standard	d1 optional	l2 (mm)	d2 standard	d2 optional	ha1 (mm)	ha2 (mm)	W (mm) ha2 - ha1
HTS-XY-12	M6	12	TR10x2	17	TR 10x2	6h9	17	TR10x2	6h9	18	38	20
HTS-XY-12-PL	M6	12	TR10x2	17	TR 10x2	6h9	17	TR10x2	6h9	18	38	20

PL = HTS-Preload-version

Order example:

The rotary knob on the y-axis can be ordered installed on the left or on the right side.

Order example for left HTS-XY-12-L-200-300 for 200 mm stroke length on the x-axis and 300 mm on the y-axis.

Order example for right HTS-XY-12-R-200-300 for 200 mm stroke length on the x-axis and 300 mm on the y-axis.

DryLin®
Linear Slide Tables

PDF: www.igus.com/iglide-pdfs
CAD: www.igus.com/iglide-CAD
RoHS info: www.igus.com/RoHS





DryLin® Linear Slide Tables - HTS HTSC - Compact Carriages

DryLin®
Linear Slide Tables

Telephone 1-800-521-2747
Fax 1-401-438-7270

Internet: <http://www.igus.com>
email: sales@igus.com
QuickSpec: <http://www.igus.com/iglide-quickspec>



Special properties

- Solid flexible design
- Ideal for 2 carriages
- Dry running and maintenance-free
- Hand wheel optional
- Adjustable radial clearance

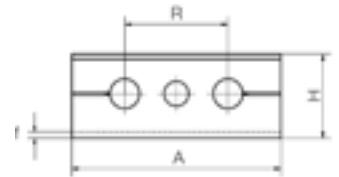
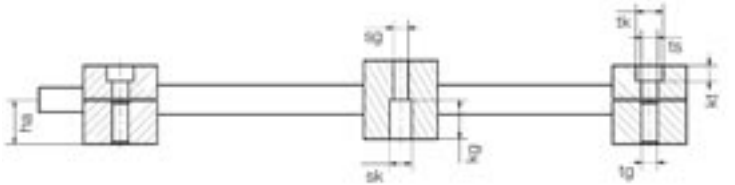
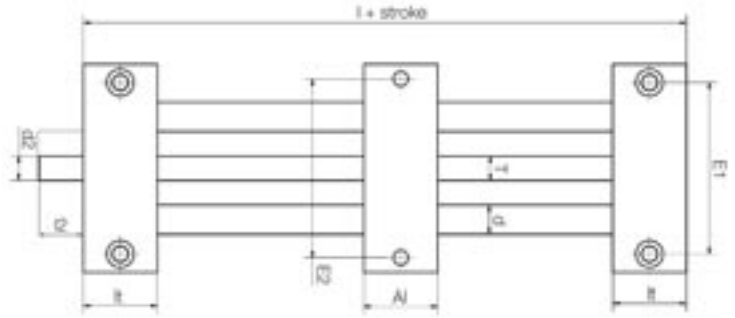

Component Materials

Part No.	Shafting	End blocks/Carriages	Bearings	Lead screw
HTSC	Hard Anodized AL*	Anodized AL	iglide® plastic	Mild Steel**

*Case hardened carbon (1050) & Hardened stainless (440C) optional

**Stainless (304SS) optional

Length (mm) and Weight

Part No.	Maximum stroke length (mm)	Linear travel/rev (mm)	Aluminum shaft		Steel shaft		Max. static load-bearing capacity	
			weight (kg)	add'l weight (per 100 mm) (kg)	weight (kg)	add'l weight (per 100 mm) (kg)	axial (N)	radial (N)
HTSC-12-AWM	750	2	0.7	0.1	0.8	0.2	700	2800
HTSC-20-AWM	1000	4	1.9	0.3	2.3	0.6	1600	6400
HTSC-30-AWM	1250	5	4.6	0.6	5.8	1.4	2500	10000
HTSC-40-AWM	1500	5	11.0	0.9	16.0	2.4	4000	16000
HTSC-50-AWM	1500	6	17.0	1.2	26.3	3.5	6250	25000

(1N = .225 lbs)

Dimensions (mm)

Part No.	A	Al -0.3	H -0.3	E1	E2 ±0.15	I ±0.15	R	f	lt	tk ±0.1	ts	tg
HTSC-12-AWM	85	30	34	70	73	90	42	2	30	11	6.6	M8
HTSC-20-AWM	130	36	48	108	115	108	72	2	36	15	9.0	M10
HTSC-30-AWM	180	50	68	150	158	150	96	4	50	20	13.5	M16
HTSC-40-AWM	230	70	84	202	202	210	122	4	70	20	13.5	M16
HTSC-50-AWM	280	80	100	250	250	240	152	4	80	20	13.5	M16

Part No.	kt ±0.1	sk	sg	kq	d	T	l2	d2 Standard	ha
HTSC-12-AWM	6.4	10	M6	6.0	12	TR10x2	17	TR10x2*	18
HTSC-20-AWM	8.6	11	M8	7.0	20	TR18x4	26	12 h9	23
HTSC-30-AWM	12.6	18	M12	10.6	30	TR24x5	38	14 h9	36
HTSC-40-AWM	12.6	20	M16	39	40	TR26x5	45	16	44
HTSC-50-AWM	12.6	20	M16	49	50	TR30x6	50	20	52

* TR10x2 supplied with lead screw end unmachined, optional 6mm available

DryLin® Linear Slide Tables - HTS HTSC-HYD - Hygienic Design

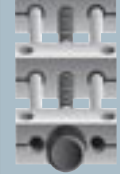

Based on the "hygienic design" idea, this version offers an easily cleaned solution. Even screw connectors are designed easily accessible and the gap dimensions accordingly generous. The materials used are plastic and 300 series stainless steel.



DryLin®
Linear Slide Tables

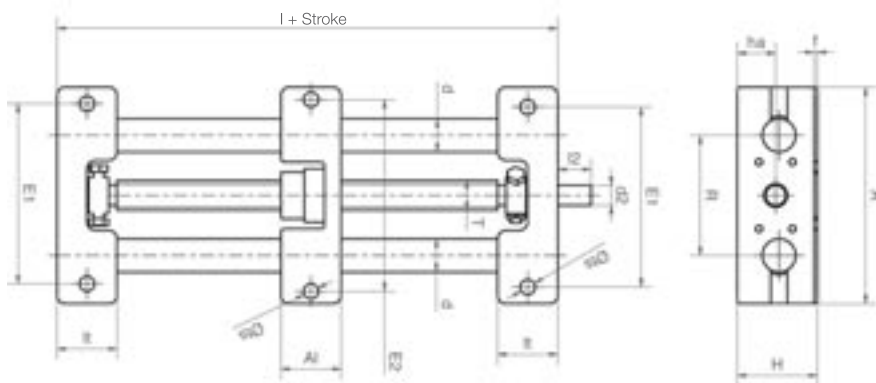

Dimensions (mm)

Part No.	A	Al	H	E1	E2	I	R	f	lt	ts	d	T	l2	d2	ha	
HTSC-20-EWM-HYD	-0.3	-0.3	48	±0.15	±0.15	108	72	2	±0.1	36	9.0	20	tr18x4	26	12h9	23

PDF: www.igus.com/iglide-pdfs
CAD: www.igus.com/iglide-CAD
RoHS info: www.igus.com/RoHS





DryLin® Linear Slide Table - HTS

HTSP - Small, Low Cost and Corrosion Resistant

HTSP is the most cost-effective and lightweight unit available. Recommended for handling low weight applications by hand or low-speed motor. HTSP works well in corrosive environments.

DryLin®
Linear Slide Tables

Telephone 1-800-521-2747
Fax 1-401-438-7270



Special properties

- Small version
- Very low weight
- Low cost
- Corrosion resistant
- Accessories optional (rotary knob, position indicator ...)
- Carriage and end blocks made from high performance polymers
- Hand wheel optional

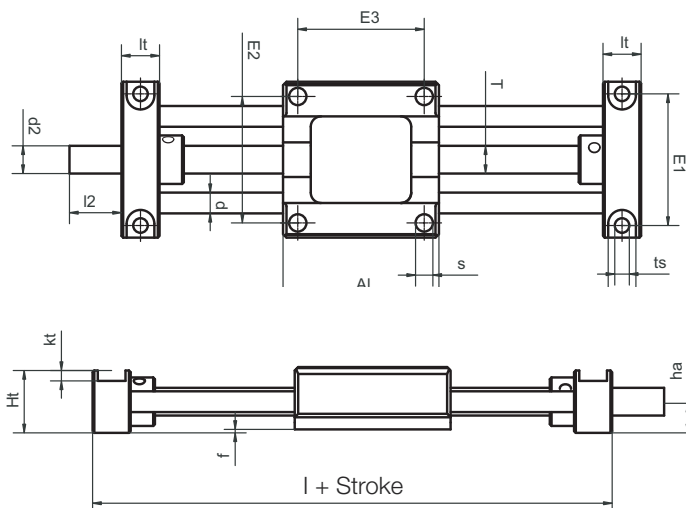
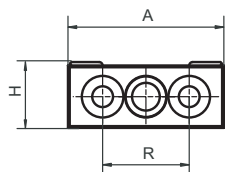

Component Materials

Part No.	Shafting	End blocks/Carriages	Bearings	Lead screw
HTSP	Hard Anodized AL*	Anodized AL	iglide® plastic	Stainless Steel

*Case hardened carbon (1050) & Hardened stainless (440C) optional

Lengths (mm) and Weight

Part No.	Linear travel/rev	Maximum stroke length (mm)	Aluminum shaft		Special properties
			weight (kg)	Add'l weight (kg) (per 100 mm)	
HTSP-01-06	1.25	300	0.11	0.06	Square carriage with four symmetrical connection bores

Dimensions (mm)

Part No.	A	AI	H	Ht	E1	E2	E3	I	R	f	lt	tk	ts
HTSP-01-06	45	45	19	18	38	36.5	36.5	67	25	1	11	8	4.2

Part No.	s	sg	d	T	I2	d2* standard	ha	Max. static load-bearing capacity	
								axial (N)	radial (N)
HTSP-01-06	5.1	-	6	M8	15	M8	9	50	200

(1N = .225 lbs)

* Standard versions supplied with lead screw end unmachined
Lead screw clamp not available

Internet: <http://www.igus.com>
email: sales@igus.com
QuickSpec: <http://www.igus.com/iglide-quickspec>

DryLin® Linear Slide Table - HTS

HTSP - Low Cost and Corrosion Resistance



HTSP is the most cost-effective and lightweight unit available. Recommended for handling low weight applications by hand or low-speed motor. HTSP works well in corrosive environments.

Special properties

- Solid plastic version
- Light weight
- Cost-effective
- Corrosion resistant
- Hand wheel optional

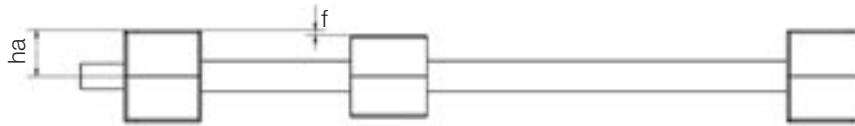
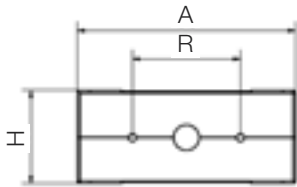
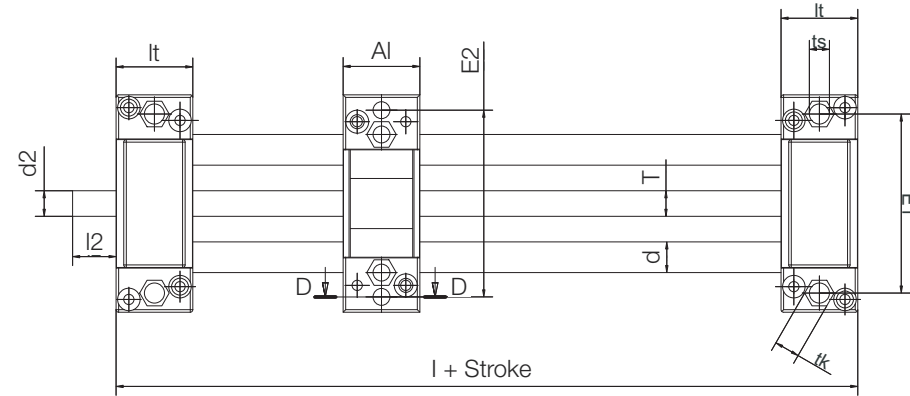
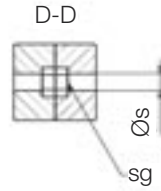

Component Materials

Part No.	Shafting	End blocks/Carriages	Bearings	Lead screw
HTSP	Hard Anodized AL*	iglide® plastic	iglide® plastic	Mild Steel**

*Case hardened carbon (1050) & Hardened stainless (440C) optional

**Stainless (304SS) optional

Length (mm) and Weight

Part No.	Linear travel/rev	Maximum stroke length (mm)	Aluminum shaft		Special properties
			weight (kg)	Add'l weight (kg) (per 100 mm)	
HTSP-01-12	2	500	0.35	0.11	Liners and TR nuts made from iglide® J
HTSP-02-12	2	500	0.35	0.11	Bearing and nut integrated into carriage

Dimensions (mm)

Part No.	A	Al	H	E1	E2	E3	I	R	f	lt	tk	ts
HTSP-01-12	85	30	36	70	73	-	90	42	2	30	10	6.6
HTSP-02-12	85	30	36	70	73	-	90	42	2	30	10	6.6

Part No.	s	sg	d	T standard	l2	d2*	ha	Max. static load-bearing capacity	
								axial (N)	radial (N)
HTSP-01-12	6.3	M6	12	TR10x2	17	TR10x2	18	45	800
HTSP-02-12	6.3	M6	12	TR10x2	17	TR10x2	18	45	800

(1N = .225 lbs)

* Standard versions supplied with lead screw end unmachined, optional 6mm available

Lifetime calculation, CAD files online: www.igus.com

DryLin®
Linear Slide Tables

PDF: www.igus.com/iglide-pdfs
CAD: www.igus.com/iglide-CAD
RoHS info: www.igus.com/RoHS





DryLin® Linear Slide Table - HTS HTSP-FF - Fast Forward

DryLin®
Linear Slide Tables

Telephone 1-800-521-2747
Fax 1-401-438-7270

Internet: <http://www.igus.com>
email: sales@igus.com
QuickSpec: <http://www.igus.com/iglide-quickspec>

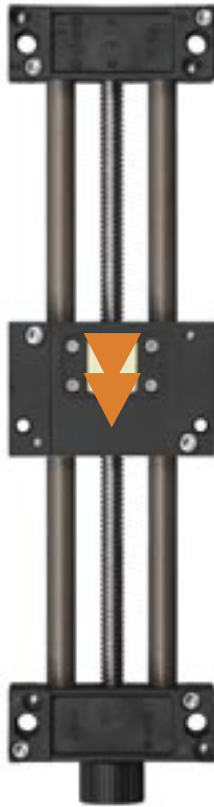

HTSP linear tables with quick release mechanism offer a combination of accurate positioning and quick manual adjustment.

Special properties

- Light solid polymer carriages and end blocks
- For fast format adjustments
- Including self-locking brake
- Variable stroke length
- Only recommended for horizontal applications
- Max. static axial load 200 N
- Max. dynamic axial load 50 N
- Hand wheel optional

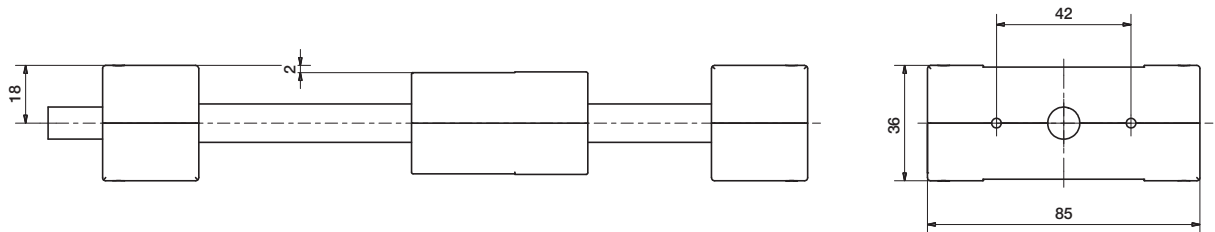
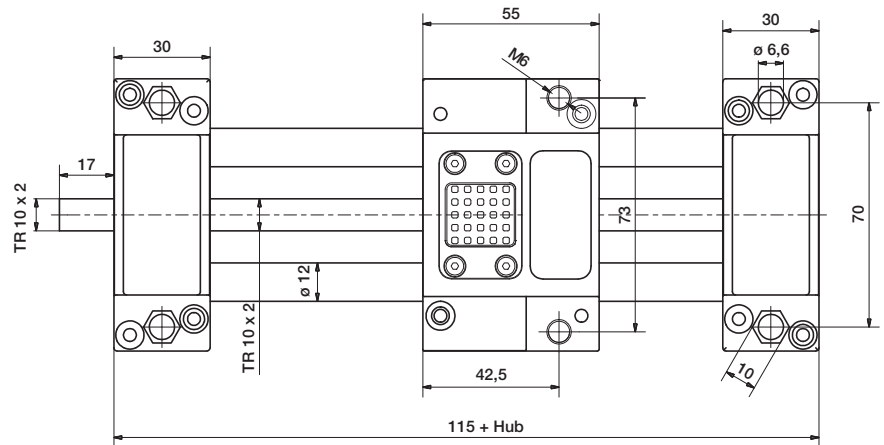

Part number	Max. length of stroke (mm)	Weight (kg)	Additional weight pro 100 mm
HTSP-01-12-AWM-FF*	750	1.1	0.1

*Liners and trapezoidal lead screw nut made of iglide® J

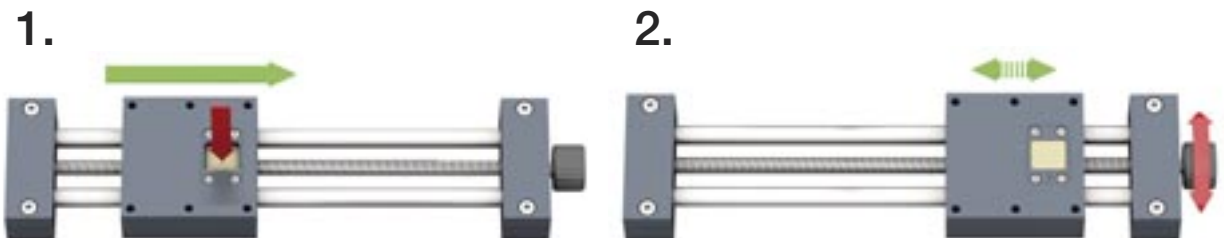

Press > disengage > move manually > click into place > fine-tune

DryLin® Linear Slide Table - SET Easy Tube

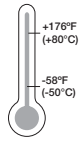

3 Dimensions
2 Styles

This new addition to the DryLin® slide table range has a simple but solid design; the complete system only consists of a few components. The anodized aluminum tube guides the slide carriage and at the same time protects the lead screw. The carriage and the trapezoidal nut are manufactured from a high performance polymer bearing material. The system runs without any lubrication, and gives a low friction value combined with an excellent wear rate. Also, iglide® plain bearings are used in the axial fixing of the lead screw.

Special properties

- Totally lubrication-free
- Corrosion-resistant when specified with a stainless lead screw
- Lightweight (aluminum and polymer)
- Can be driven from both sides by hand or motor drive
- Temperature-resistant up to 176°F (80° C)
- Ideal for washdown applications
- Covered lead screw



Easy Tube with optional accessory (rotary knob, position indicator)



Flange version

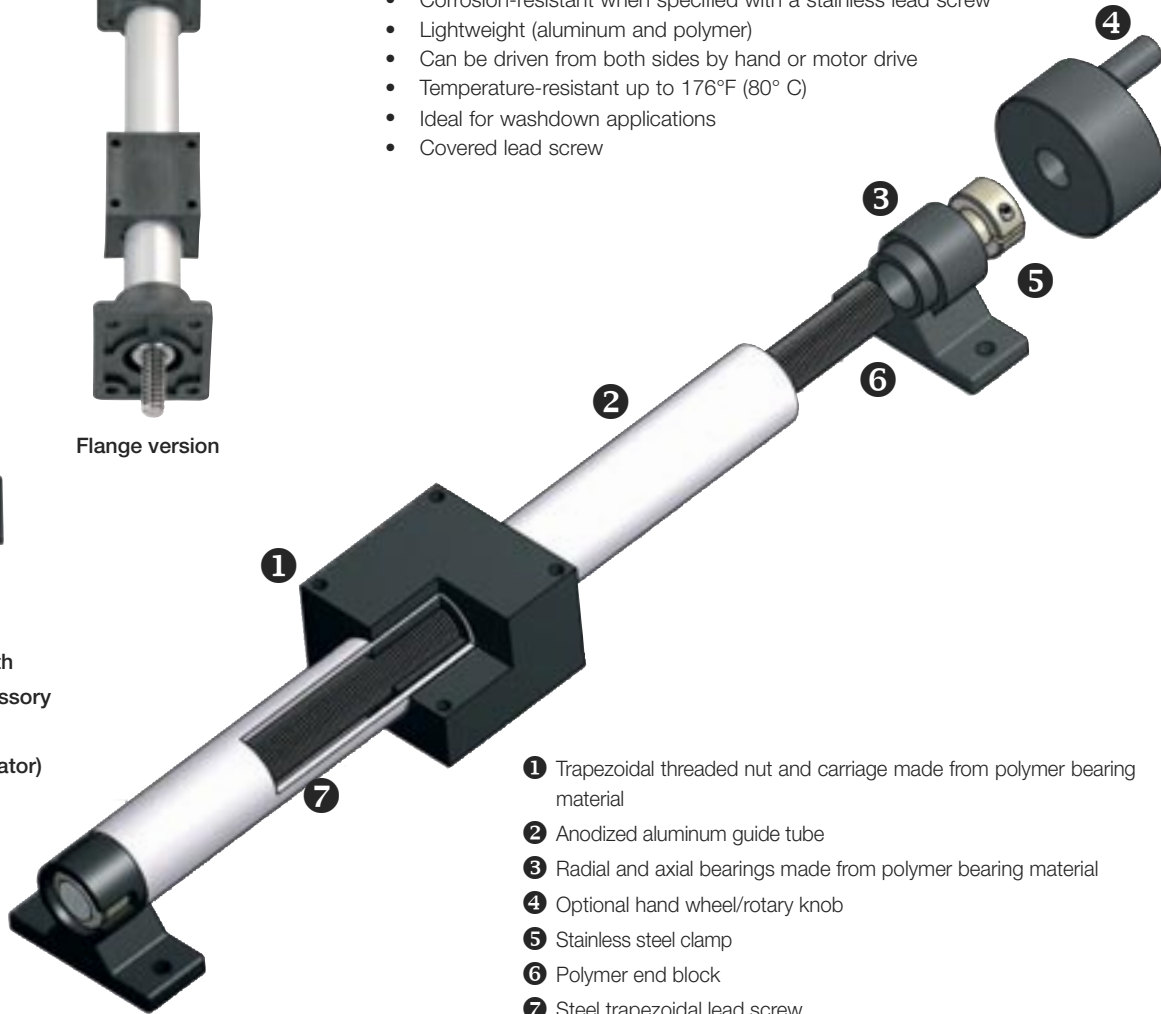

- 1 Trapezoidal threaded nut and carriage made from polymer bearing material
- 2 Anodized aluminum guide tube
- 3 Radial and axial bearings made from polymer bearing material
- 4 Optional hand wheel/rotary knob
- 5 Stainless steel clamp
- 6 Polymer end block
- 7 Steel trapezoidal lead screw

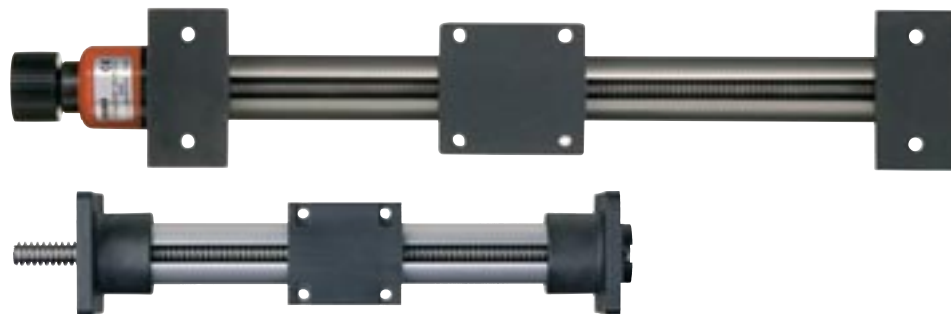

Flange version

DryLin®
Linear Slide Tables

PDF: www.igus.com/iglide-pdfs
CAD: www.igus.com/iglide-CAD
RoHS info: www.igus.com/RoHS





DryLin® Linear Slide Table - SET Easy Tube

DryLin®
Linear Slide Tables

Telephone 1-800-521-2747
Fax 1-401-438-7270

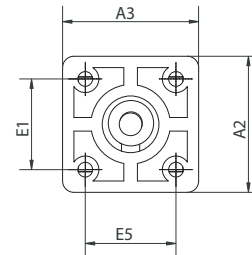
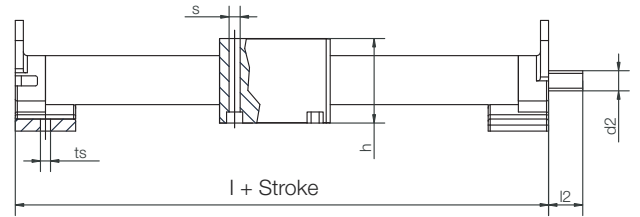
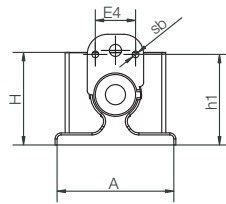
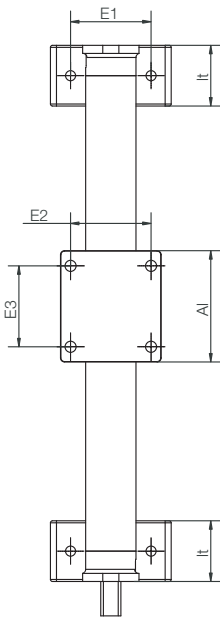

also available as flange version
(for axial fitting)

Stainless shaft/lead screw available upon request

Length (mm) and Weight

Part No.	Linear travel/rev (mm)	Maximum stroke length (mm)	Aluminum Shaft		Max. static load-bearing capacity	
			weight (kg)	add'l weight (per 100 mm) (kg)	axial (N)	radial (N)
SET-12-AWM	.7	200	0.05	0.03	10	20
SET-25-AWM	2	850	0.15	0.12	150	300
SET-30-AWM	3	850	0.20	0.21	200	400

(1N = .225 lbs)

Dimensions (mm)

Part No.	A	A1	H	E1	E2	E3	E4	l	h	h1	lt	ts	s	sb	l2	d2
SET-12-AWM	30	30	23.5	20	20	20	-	60	22	-	15	3.3	4.2	-	10	M4*
SET-25-AWM	60	55	44	40	40	40	20	115	39	45	30	5.2	5.2	M4	17	TR10x2*
SET-30-AWM	80	55	49	60	40	40	20	125	39	50	35	6.5	5.2	M4	20	TR12x3*

Dimensions (mm) – flange version

Part No.	A2	A3	H	E1	E2	E3	E5	l	h	lt	ts	s	l2	d2
SET-25-AWM-F	60	60	49	40	40	40	40	117	39	30	5.2	5.2	27	TR10x2*
SET-30-AWM-F	80	60	59	60	40	40	40	125	39	35	6.5	5.2	30	TR12x3*

* lead screw end unmachined

Internet: <http://www.igus.com>
email: sales@igus.com
QuickSpec: <http://www.igus.com/iglide-quickspec>

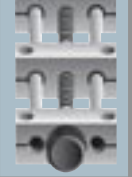

Brackets for X-Y Axes

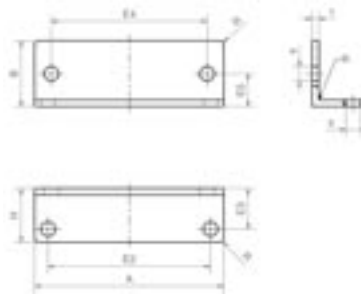

Part No.	A (mm)	H (mm)	B (mm)	E2 (mm)	E3 (mm)	E4 (mm)	E5 (mm)	s (mm)	t (mm)
HTS-WS-12	85	26.5	30	73	20.5	70	15	6.5	3
HTS-WS-20	130	36	35	108	18	115	35	8.5	5

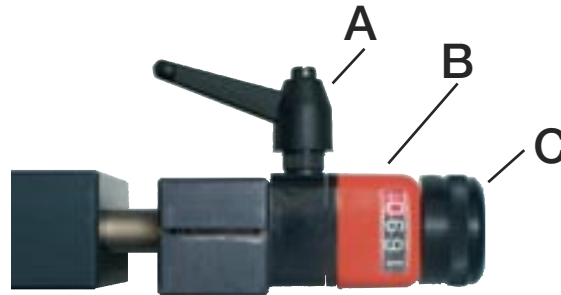

A - Lead screw clamp



Special properties

- Shaft clamping flange for attachment to the position indicator and subsequent mounting on the lead screw
- Provides a mechanical brake to the lead screw
- Material: Plastic housing with aluminum shaft clamp
- Color: Black

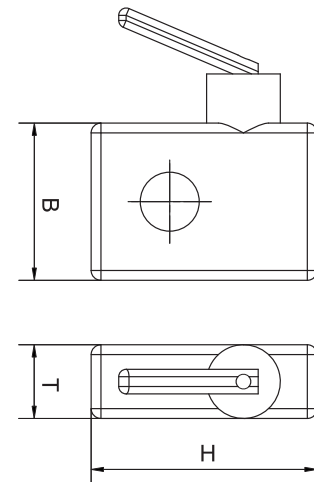

Part No.	HTS-HK-12	HTS-HK-16	HTS-HK-20	HTS-HK-30
Lead screw size	TR10x2	TR14x4	TR18x4	TR24x5
Dimensions (BxHxT) in mm	32x46x15	32x46x15	32x46x15	32x46x15
Corresponding Slide Tables				
HTS	HTS-12		HTS-20	HTS-30
HTSC	HTSC-12		HTSC-20	HTSC-30
HTSP	HTSP-12			
SLW(S)	SLW-1040*	SLW-1660*	SLW-2080*	
SET	SET-25			

* Only possible with an adapter plate





B - Position indicator



Special properties

- Plastic analog indicator for adjustment and direct reading of slide position
- 4-digit counter (red digit indicates tenths)
- Counting takes place clockwise
- Color: Orange

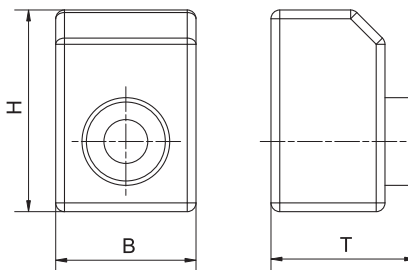
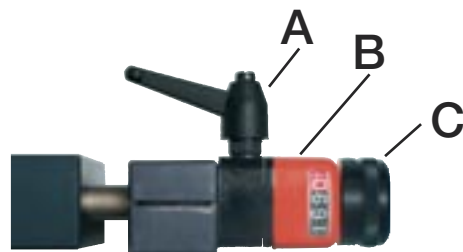

Part No.	Lead screw Size	Dimensions B x H x T (mm)	Corresponding Slide Tables					
			HTS	HTSC	HTSP	SLW	SET	
HTS-PA-06	M8	22x33x31	HTSP-01-06*					
	TR8x1.25							
HTS-PA-12	TR10x2	32x46x33	HTS-12	HTSC-12	HTSP-12	SLW-1040*	SET-25	
	10x12							
	10x50							
	TR10x3							
HTS-PA-16	TR14x4	32x46x33				SLW-1660*		
HTS-PA-20	TR18x4	32x46x33	HTS-20	HTSC-20		SLW-2080*		
	18x100							
HTS-PA-30	TR24x5	32x46x33	HTS-30	HTSC-30				

* Only possible with an adapter plate



0 degrees



90 degrees



180 degrees



270 degrees



A (standard)



B (optional)
for vertical fitting position:
display turned 180°

Pitch	For lead screw	Display after 1 rotation
1.25	M8 x 1.25; TR8x1.25	001.25
2	TR10x2	002.0
3	TR10x3; TR12x3	003.0
4	TR18x4; TR14x4	004.0
5	TR24x5	005.0
12	10 x 12	012.0
50	10 x 50	005.0
100	18 x 100	001.0

The pitch depends on the lead screw used

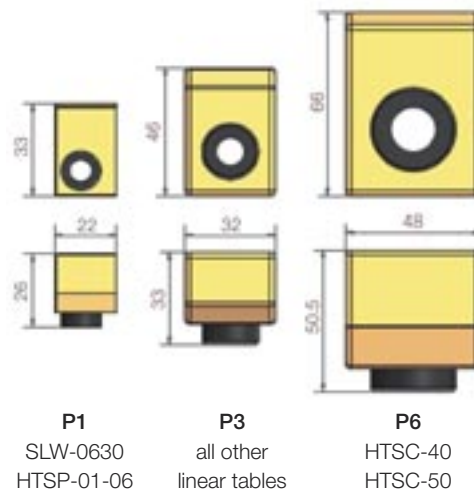

P1
SLW-0630
HTSP-01-06

P3
all other
linear tables

P6
HTSC-40
HTSC-50

DryLin® Linear Slide Tables - HTS Accessories

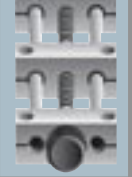

C - Rotary knob



Special properties

- Rotary knob for attachment to the end of the lead screw
- For positioning
- Material: Aluminum and Polymer
- Color: Black

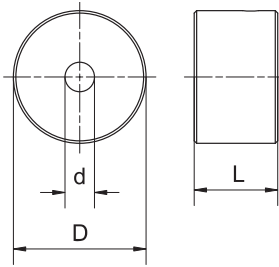
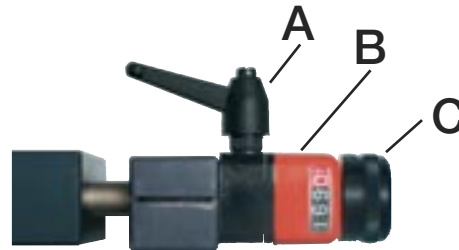

Dimensions (mm)

Part No.	D	L	d	For Slide Tables
HTS-HR-06	27	17	8	HTSP-06, SLW-0630
HTS-HR-12	27	17	10	SLW-1040, SLWS-1040, HTS / HTSC / HTSS / HTSP / 12, SET-25
HTS-HR-16	34	20	14	SLW-1660
HTS-HR-20	42	23	12	SLW-2080, HTS / HTSC / HTSS20
HTS-HR-30	42	23	14	HTS / HTSC-30

Hand Wheel



- Large diameter hand wheel
- Handles are fixed

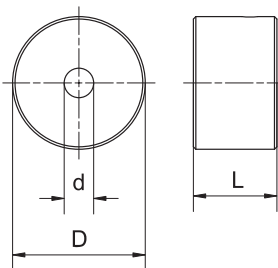

Dimensions (mm)

Part No.	D	L	d	For Slide Tables
HTS-HR12-80RH	27	17	8	SLW-1040, SLWS-1040, HTS / HTSC / HTSS / HTSP/12, SET-25
HTS-HR12-100RH	27	17	10	SLW-1040, SLWS-1040, HTS / HTSC / HTSS / HTSP/12, SET-25
HTS-HR16-120RH	34	20	14	SLW-1660, HTS / HTSC / HTSS30
HTS-HR20-100RH	42	23	12	SLW-2080, HTS / HTSC / HTSS20

DryLin®
Linear Slide Tables

PDF: www.igus.com/iglide-pdfs
CAD: www.igus.com/iglide-CAD
RoHS info: www.igus.com/RoHS





DryLin® Linear Slide Tables - HTS HTS-WT V-DRIVE

DryLin®
Linear Slide Tables

Telephone 1-800-521-2747
Fax 1-401-438-7270

Internet: <http://www.igus.com>
email: sales@igus.com
QuickSpec: <http://www.igus.com/iglide-quickspec>

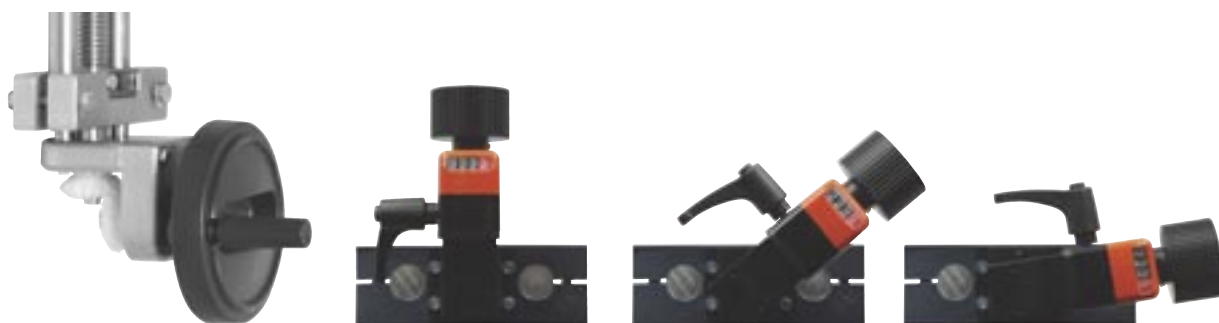

HTS V-drive

The standard for three dimensions as closed system with aluminum housing.

- Suits any application with continuously variable adjustment (can be oscillated 360°)
- Motor or manual operation
- Max. torque 3 Nm
- Adapter for DryLin® lead screw clamp and position indicator
- Compatible with DryLin® HTS/HTSC/HTSS (dimensions 12, 20 and 30)

Hygienic Design V-drive

Following the idea of "Hygienic Design" the V-drive is available as maintenance-free and washable stainless steel/polymer system.

- Lubrication-free
- Max. torque 3 Nm
- Single parts made of stainless steel
- Easy to clean with water
- Compatible with DryLin® HTS/HTSC (dimensions 20 and 30)

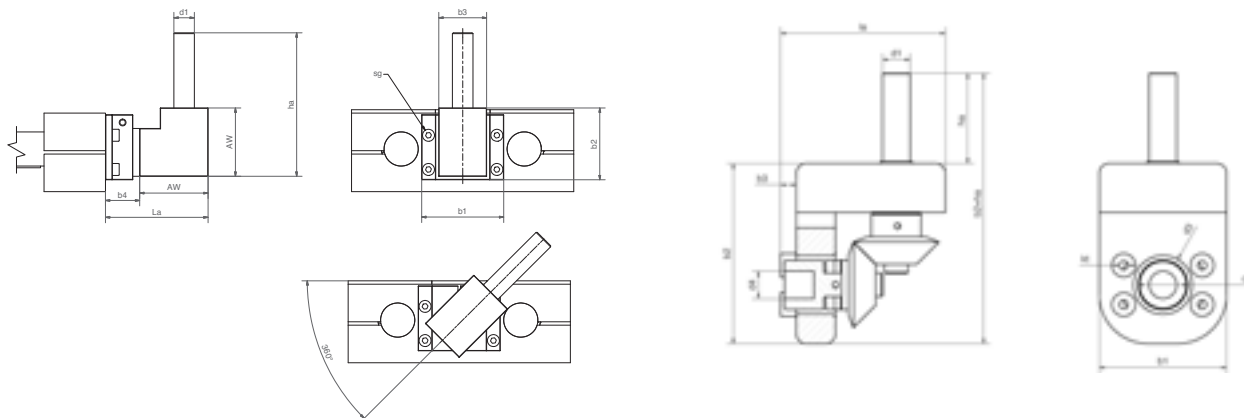

Dimensions (mm)

Part No.	l	AW	La	b1	b2	b3	b4	ha	d1	sg
HTS-WT-3000	30	30	23.5	20	20	20	-	60	22	-

Part No.	l	kt	La	b2+ha	b1	b2	b3	b4	ha	d1	d2	d3	sg
HTSWT20ESHYD	01:01	45	84	variable	65	92	8	8	variable	14	25	30	14

DryLin® Linear Slide Tables - HTS Accessories

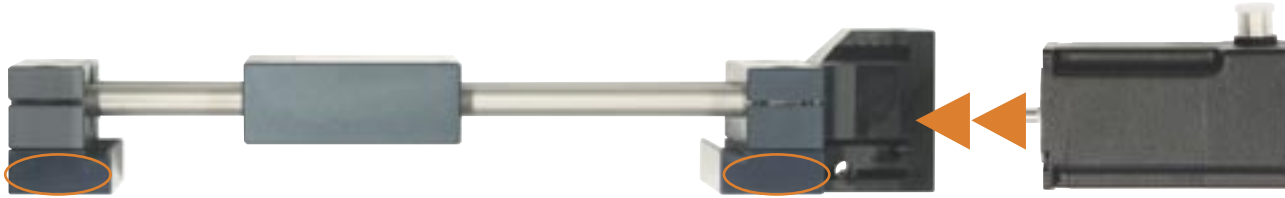

* Motor not supplied

Spacer

The spacer elevates the linear unit to the correct height for use with your NEMA23 motor. These can be retrofitted to existing units

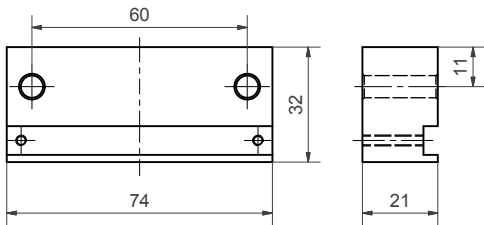

STY-104001

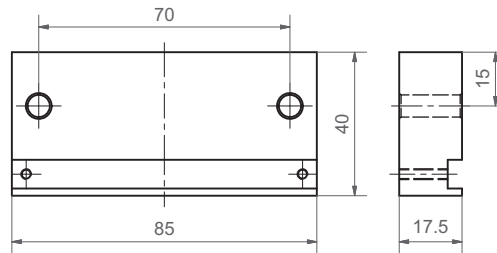

STY-121001

Part No.	For linear unit	For Motor type	Material
STY-104001	SLW-1040 / SLWE-1040	NEMA23	Aluminum, clear anodized
STY-121001	HTS-12 / HTSC-12 / HTS-12-PL / HTSS-12	NEMA23	Aluminum, blue-grey anodized

Motor Flange



The motor flange incorporates the coupling and offers the correct mating dimensions for your NEMA23 motor.

Part No.	For linear unit	For Motor type	Material
MF-2040-NEMA23	SAW-1040 / SLW-1040 / SLWE-1040 HTS-12 / HTSC-12 / HTS-12-PL / HTSS-12	NEMA23	Aluminum, black anodized

Coupling



The coupling connects the lead screw and the drive shaft of the motor and transfers the torque. Elastic elements prevent tensioning between the components.

Part No.	Motor type	ø Motor journal	ø Outer dimension (mm)	From stock available Inner diameter (mm)	Length (mm)
COU-AR-K-XXX	NEMA23	please name	32	5 / 6.35 / 8 / 10 / 12 / 14	32

DryLin®
Linear Slide Tables

PDF: www.igus.com/iglide-pdfs
CAD: www.igus.com/iglide-CAD
RoHS info: www.igus.com/RoHS





DryLin® Linear Slide Table ZLW Belt-Drive System

DryLin®
Linear Slide Tables

Telephone 1-800-521-2747
Fax 1-401-438-7270

Internet: <http://www.igus.com>
email: sales@igus.com
QuickSpec: <http://www.igus.com/iglide-quickspec>

- Developed for high-speed applications with low loads
- Extremely cost-effective versus ball bearing drive systems
- Work well in dirty, dusty environments and clean environments
- Better for high accelerations than ball bearings
- Low-temperature and underwater versions available
- Quiet operation



ZLW-1040 (45mm H x 74mm W)

ZLW-1040-LCB: (Formerly ZLW-1040-B "basic") Low cost basic version uses a glass-reinforced neoprene belt and is meant for lower load and speed applications than version S

ZLW-1040-S: Standard table with steel-reinforced polyurethane belt, enhanced pulley system and other components for higher speed and load applications than version LC

ZLW-1040-UW: Specially made for underwater applications

ZLW-1040-LT: Low temperature version for temps -7.6°F



ZLW-0630 miniature version (31mm H x 54mm W)

ZLW-0630-LCB: (Formerly ZLW-0630-B "basic") Low cost basic version uses a glass-reinforced neoprene belt and is meant for lower load and speed applications than version S

ZLW-0630-S: Standard table with steel-reinforced polyurethane belt, enhanced pulley system and other components for higher speed and load applications than version LC

Maximum load ZLW-0630/1040 100% operating time

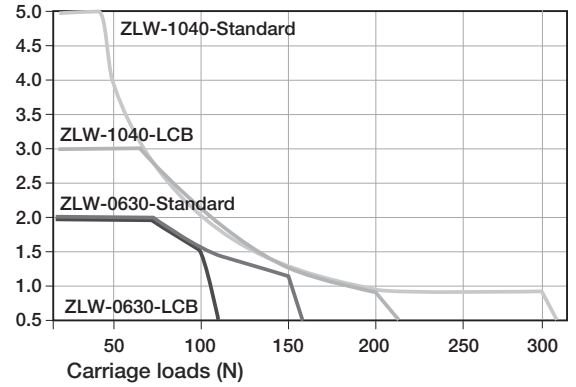

The diagram accounts for the sum of all forces active on the carriage



ZLW used on plasma TV CNC cutting machine

All dimensions in mm (1 mm = 0.04") - 1 N = .225 lbs. See catalog for more details.

Technical Data

	Weight without stroke (kg)	Weight 100 mm stroke (kg)	Max. stroke length* (mm)	Linear travel per rev. (mm)	Gear-teeth	Toothed belt- -material	-width (mm)	-tension N	Max. radial stress N (lbf)	Belt Pulley	Max. Speed at 60% operation (m/s)	Linear positioning tolerance
ZLW-1040												
LCB	0.9	0.14	2,000	66	RPP 3M	Neoprene with GF	15	150	200 (45)	ball bearing	3	±0.35
Standard	1.0	0.14	2,000	70	AT 5	PU + steel cord	16	200	300 (67)	ball bearing	5	±0.2
ZLW-0630												
LCB	0.43	0.08	1,000	54	HDT 3•4	Neoprene with GF	9	70	100 (22)	ball bearing	2	±0.2
Standard	0.43	0.08	1,000	54	MTD 3	PU + steel cord	9	100	150 (34)	ball bearing	2	±0.2

*Larger stroke lengths upon request

**These values were measured with maximum load in horizontal orientation

DryLin® Linear Slide Table - Assembly of the Belt Drive

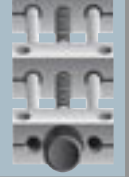

ZAW-1040 cantilever axis

Lightweight and ideal for applications where you want the rail to move, and the carriage static, such as Z-axis applications



ZLW-1040-OD: Opposite drive

2 carriage opposite drive for bi-directional movement

Clearance Adjustment Available



ZLW-1040 can be fitted with Turn-To-Fit carriages for clearance adjustment



DryLin®
Linear Slide Tables

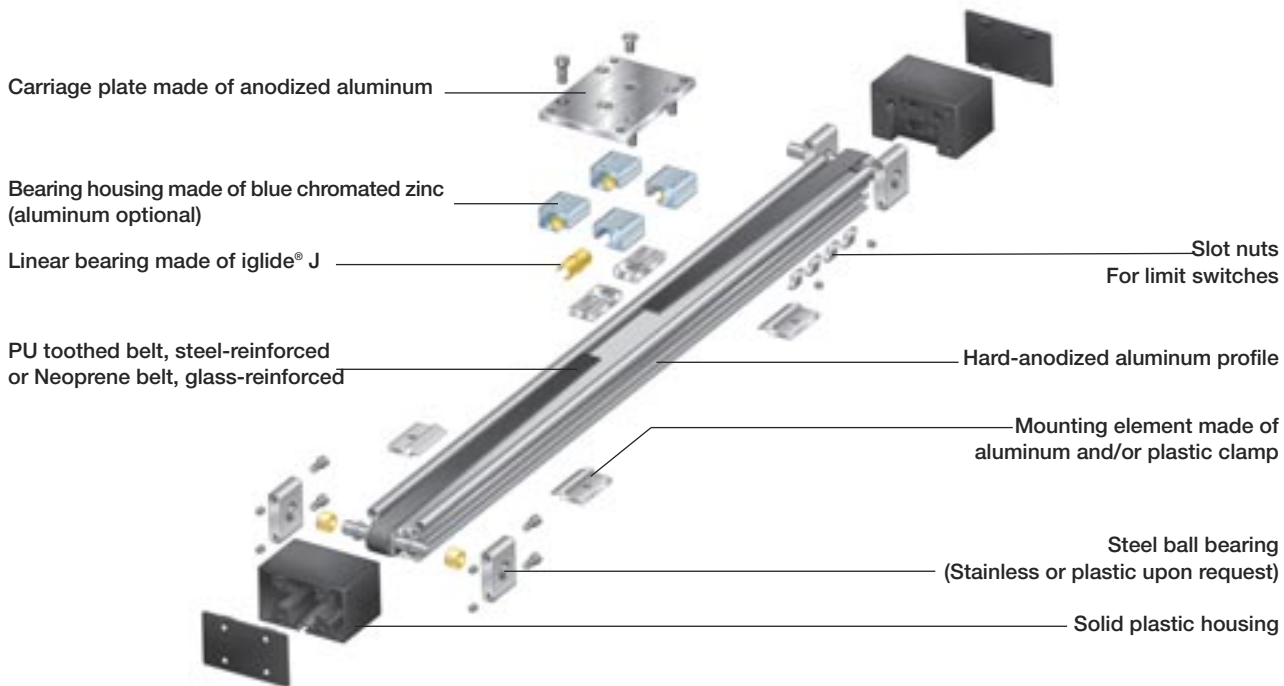

PDF: www.igus.com/iglide-pdfs
CAD: www.igus.com/iglide-CAD
RoHS info: www.igus.com/RoHS



Assembly of the part number

ZLW -1040 -02 -B -100 L XX

Right or left positioning for drive shaft.
Position determined by view towards x!
1 = Left drive shaft
2 = Right drive shaft
x = Line of vision

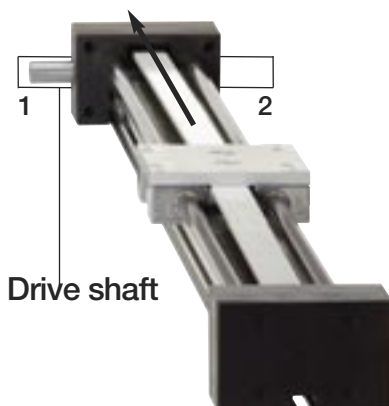

- Stroke length in mm
- L = drive shaft on the left
- R = drive shaft on the right
- L/R = drive shafts left and right
- Slide length in mm (Standard: 100, on request: 50/200 mm)
- Size 1040: 100 (optional 150/200 mm)
- Size 0630: 60
- B = LCB
- S = Standard series
- Version 01 (optional) – Drive shaft with L250 plain bearings
- Version 02 (faster speed) – Drive shafts with ball bearings
- Size 1040 (Guide shaft diameter 10 / Shaft width 40 mm)
- Size 0630 (Guide shaft diameter 6 / Shaft width 30 mm)
- DryLin® W toothed belt linear drive



DryLin® Linear Slide Table - ZLW 0630 Belt Drive

DryLin®
Linear Slide Tables

Telephone 1-800-521-2747
Fax 1-401-438-7270

Internet: <http://www.igus.com>
email: sales@igus.com
QuickSpec: <http://www.igus.com/iglide-quickspec>



Special properties

- Compact size
- Speeds up to 6.5 ft/s
- Maintenance-free
- For strokes up to 1000 mm
- Available in both LC and S versions

ZLW-0630-LCB: (Formerly ZLW-0630-B "basic") Low cost basic version uses a glass-reinforced neoprene belt and is meant for lower load and speed applications than version S

ZLW-0630-S: Standard table with steel-reinforced polyurethane belt, enhanced pulley system and other components for higher speed and load applications than version LC

Technical Data

	Weight without stroke (kg)	Weight 100 mm stroke (kg)	max. stroke length* (mm)	Transmission (mm/U)	Gear-teeth	Toothed belt -material	-width (mm)	-tension (N)	max. radial stress (N)	Pulley	max. speed at 60% operation (m/s)	Linear positioning tolerance
ZLW-0630												
LCB	0.43	0.08	1.000	54	AT 5	Neoprene with GF	9	70	100	ball bearing	2.5	±0.2
Standard	0.43	0.08	1.000	54	MTD3	PU + steel cord	9	100	100	ball bearing	2	±0.2

* Larger stroke lengths upon request.

** These values were measured with maximum load in horizontal orientation

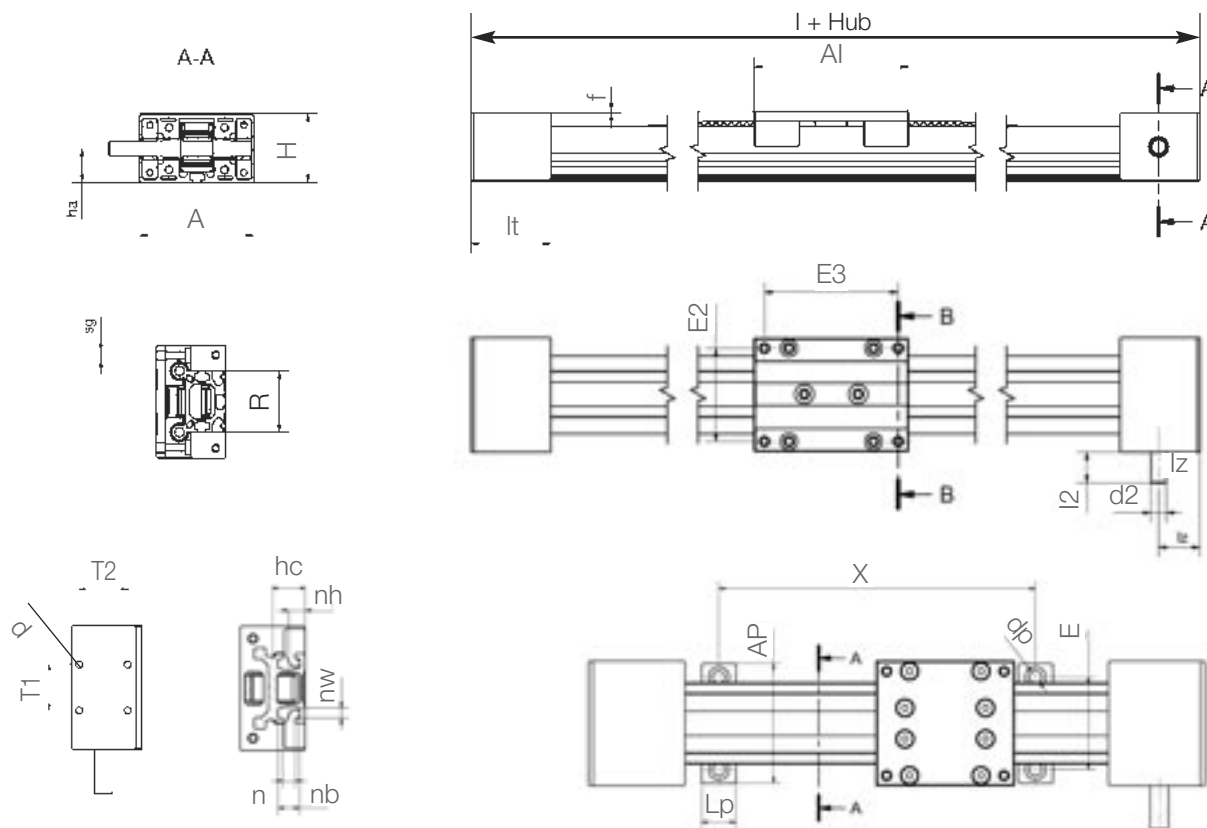

Dimensions (mm) for LCB and S versions

Part No.	A	AI	H	E2	I	hc	E3	R	f	lt	sg	ha	lz	I2	d2
ZLW-0630-02-...	-0.3 54	60	31	±0.15 45	144	13.5	±0.15 51	±0.15 30	3	±0.3 42	M4	14	22	20	*8/10
Part No.	X	E	AP	LP	dp	n	nb	nw	nh	T1	T2	d			
ZLW-0630-02-...	variable	±0.2 40	-1 52	15	5.5	5.2	9.5	4.3	7	±0.25 20	±0.25 21	3.2			

* 'LCB' version has a 6mm square output shaft with 10mm OD plastic adapter. Stainless adapter optional

DryLin® Linear Slide Table - ZLW 0630 Belt Drive

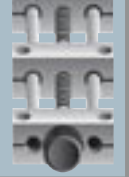

DryLin®
Linear Slide Tables

PDF: www.igus.com/iglide-pdfs
CAD: www.igus.com/iglide-CAD
RoHS info: www.igus.com/RoHS



Horizontal orientation

ZLW-0630-02-LCB

Required drive torque*

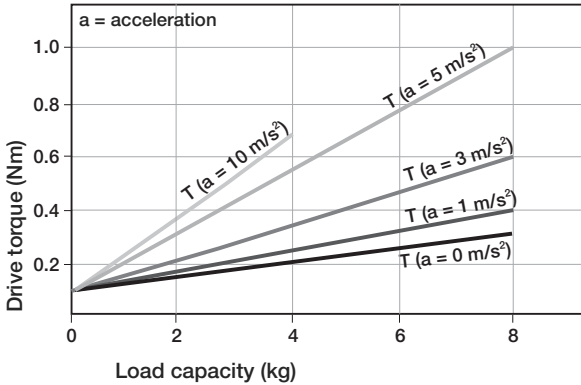

Vertical orientation

ZLW-0630-02-LCB

Required drive torque*

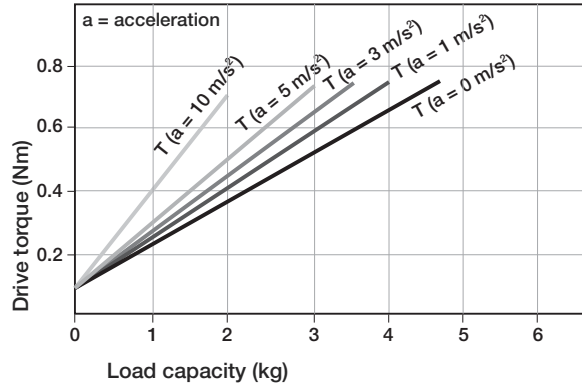

Horizontal orientation

ZLW-0630-02-S

Required drive torque*

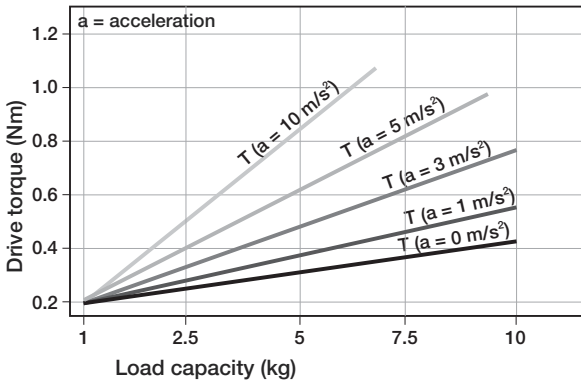

Vertical orientation

ZLW-0630-02-S

Required drive torque*

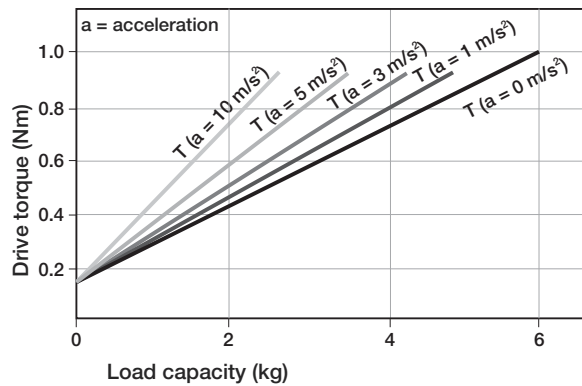

* Assumption: The moving mass is located in a circumscribed circle with a max. R = 100 mm to the middle of the guiding rail, max. permissible torque version 01: 1.3 Nm, a = 0 m/s²; version 02: 2.4 Nm, a = 0 m/s²; constant drive without nominal value acceleration

Maximum load

ZLW-0630/1040

100% operating time

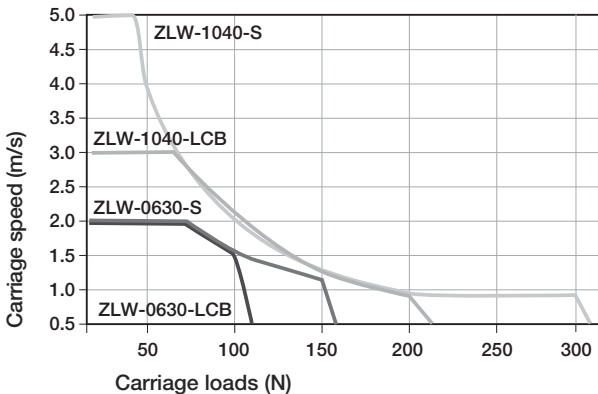

For unsupported applications

Rail deflection between supports

Versions LCB and S

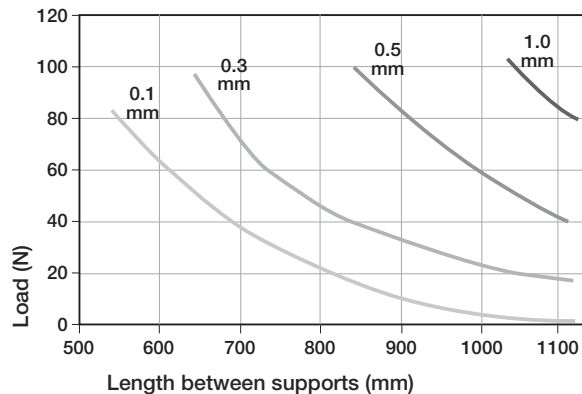

The diagram accounts for the sum of all forces active on the carriage.

Sag permissible up to maximum 2 mm.



DryLin® Linear Slide Table - ZLW 1040 Belt Drive

DryLin®
Linear Slide Tables

Telephone 1-800-521-2747
Fax 1-401-438-7270

Internet: <http://www.igus.com>
email: sales@igus.com
QuickSpec: <http://www.igus.com/iglide-quickspec>

30.38



ZLW-1040-LCB: (Formerly ZLW-1040-B "basic") Cost-effective version uses a glass-reinforced neoprene belt and is meant for lower load and speed applications than version S

ZLW-1040-S: Standard table with steel-reinforced polyurethane belt, enhanced pulley system and other components for higher speed and load applications than version LC

Special properties

- High speed, up to 16.4 ft/s (5 m/s)
- Maintenance-free
- Lightweight
- Cost-effective versus other actuator systems
- Maximum stroke, 2000 mm

	Weight without stroke (kg)	Weight 100 mm stroke (kg)	max. stroke length* (mm)	Transmission (mm/U)	Gear-teeth	Toothed belt- -material	-width (mm)	-tension (N)	max. radial stress (N)	Pulley	max. speed at 60% operation (m/s)	Linear positioning tolerance
ZLW-1040												
LCB	0.9	0.14	2.000	66	RPP 3M	Neoprene with GF	15	150	200	ball bearing	3	±0.35
Standard	1.0	0.14	2.000	70	AT 5	PU + steel cord	16	200	300	ball bearing	5	±0.2

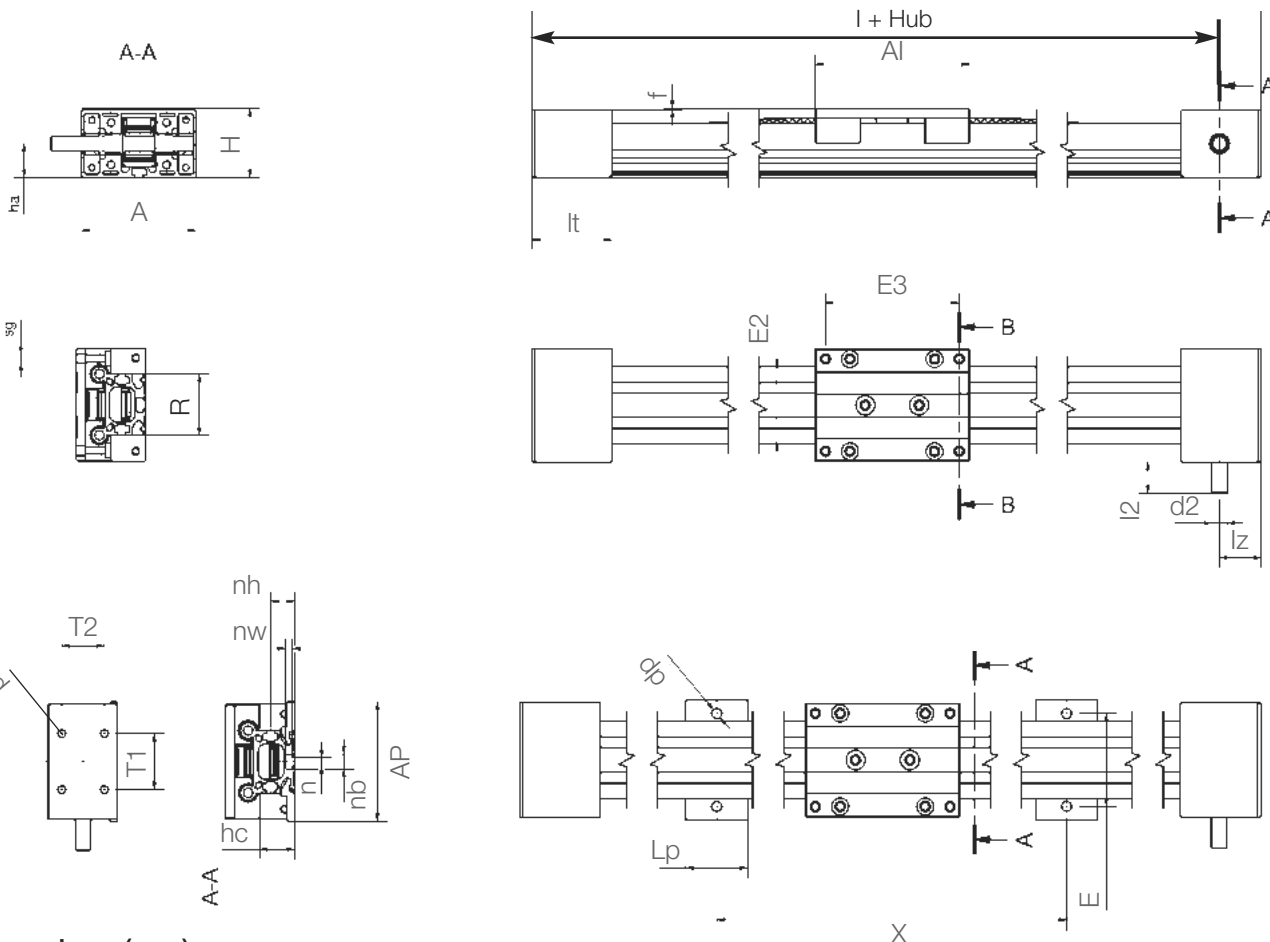

Dimensions (mm)

Part No.	A	AI	H	E2	I	hc	E3	R	f	lt	sg	ha	lz	l2	d2
ZLW-1040-02-...	-0.3			±0.15			±0.15	±0.15		±0.3					
ZLW-1040-02-...	74	100	45	60	204	22.5	87	40	1	52	M6	22	27	20	*10

Part No.	X	E	AP	LP	dp	n	nb	nw	nh	T1	T2	d
ZLW-1040-02-...	variable	±0.2	-1							±0.25	±0.25	
ZLW-1040-02-...		60	78	40	6,4	5.2	9.5	4.3	15.5	36	26.5	5.0

* 'LCB' version has a 6mm square output shaft with 10mm OD plastic adapter. Stainless adapter optional

DryLin® Linear Slide Table - ZLW 1040 Belt Drive

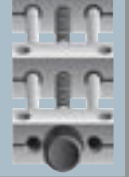

DryLin®
Linear Slide Tables

PDF: www.igus.com/iglide-pdfs
CAD: www.igus.com/iglide-CAD
RoHS info: www.igus.com/RoHS



Horizontal orientation

ZLW-1040-02-LCB

Required drive torque, Nm

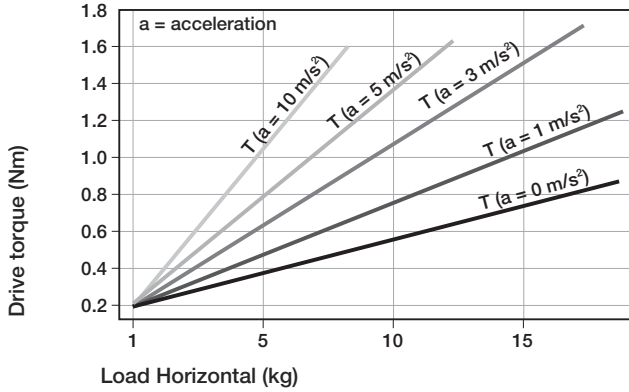

Vertical orientation

ZLW-1040-02-LCB

Required drive torque, Nm

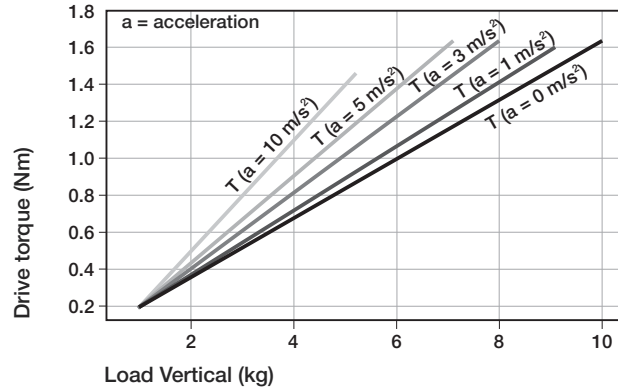

Horizontal orientation

ZLW-1040-02-S

Required drive torque, Nm

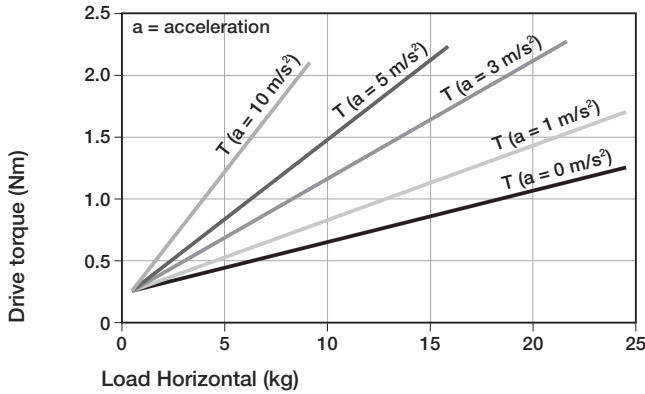

Vertical orientation

ZLW-1040-02-S

Required drive torque, Nm

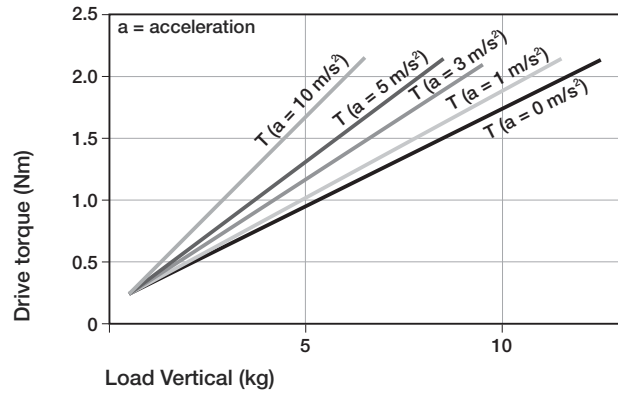

* Assumption: The moving mass is located in a circumscribed circle with a max. R = 100 mm to the middle of the guiding rail, max. permissible torque version 01: 1.3 Nm, a = 0 m/s²; version 02: 2.4 Nm, a = 0 m/s²; constant drive without nominal value acceleration

Maximum load comparison

ZLW-0630 and ZLW-1040

100% operating time

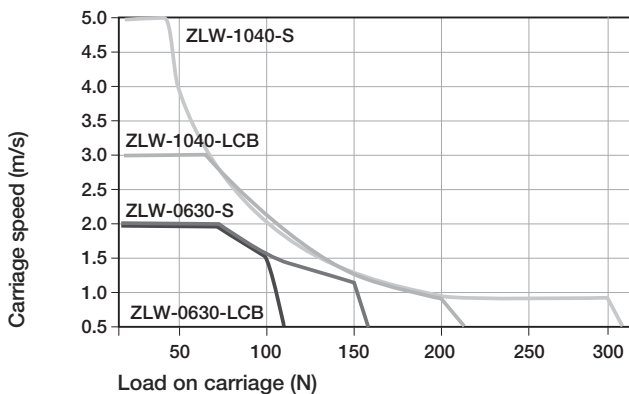

For unsupported applications

Rail deflection between supports

Versions LCB and S

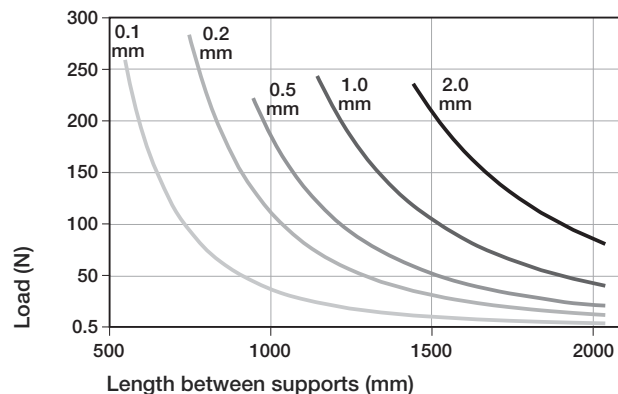

The diagram accounts for the sum of all forces active on the carriage.

Sag permissible up to maximum 2 mm.



DryLin® Linear Slide Table - ZAW

DryLin®
Linear Slide Tables

Telephone 1-800-521-2747
Fax 1-401-438-7270

Internet: <http://www.igus.com>
email: sales@igus.com
QuickSpec: <http://www.igus.com/iglide-quickspec>

Special properties

- Low weight
- Maintenance-free
- High rigidity
- Perfect for applications where the rail moves, but the carriage is stationary

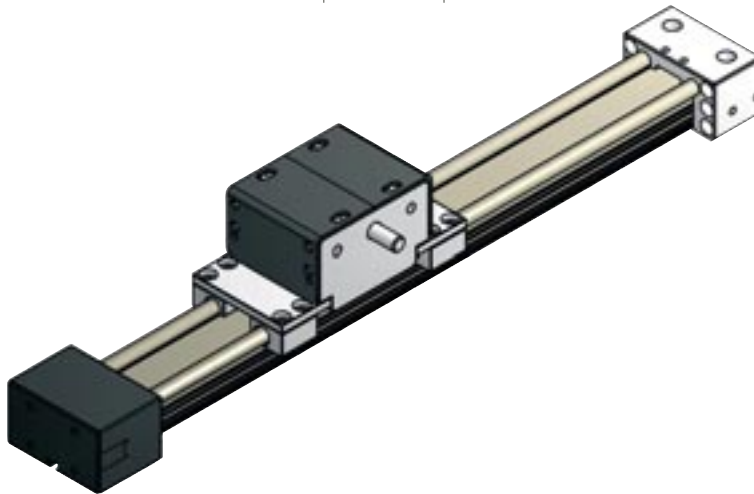
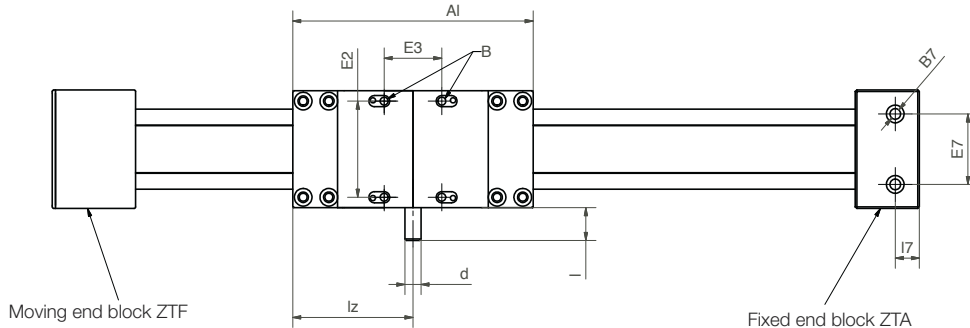
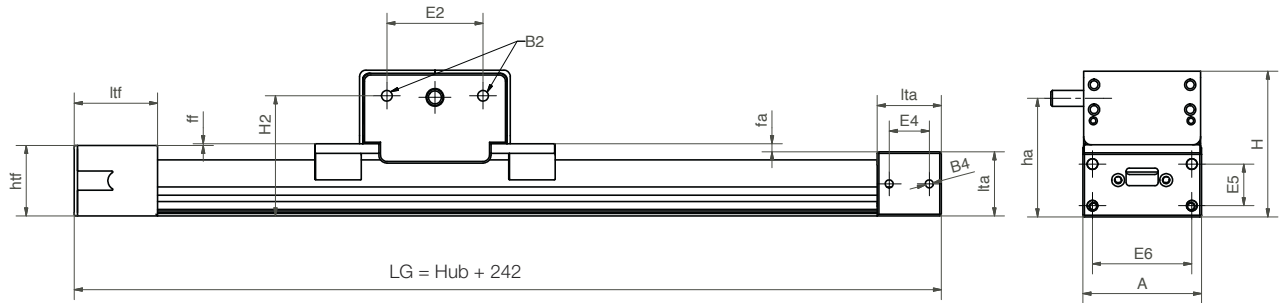

Dimensions (mm)

Part No.	A -0.3 (mm)	H (mm)	LG Hub (mm)	Al ±0.3 (mm)	ha ±0.1 (mm)	d h9 (mm)	l +1 (mm)	l _z (mm)	E2 ±0.15	E3 ±0.15 (mm)
ZAW-1040-02-R/L-LG	74	91	242	150	74	10	20	75	60	60

Part No.	B -0.3	B2	htf Hub (mm)	l _{tf} ±0.3 (mm)	ff ±0.1 (mm)	fa h9 (mm)	l _{ta} +1 (mm)	E4 (mm)	B4 ±0.15	E5 ±0.15 (mm)	E6 (mm)
ZAW-1040-02-R/L-LG	M6	M8	44	52	2	5	40	25	M6	26	62

DryLin® Linear Slide Table - ZLW Belt Drive



The DryLin® ZLW belt drive can be fastened in different ways (clamp and slot nuts included in delivery):

The orientation of the drive is optional. Overhead installation is the best option against fouling.

- 1. Clamping** offers an easy fastening option for the drive, on aluminum machine profiles and other surfaces. Part No. 75.40.
- 2. Slot nuts** enable the mounting on 3 sides (1040: left, right, below) or 2 sides (0630: left, right) as well as the fixing of sensors and proximity switches.
- 3. Screw connection:** Threaded holes are located at each end block face.

1. Clamp mount

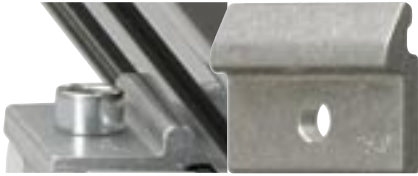

Included in delivery

2. Slot nuts



Ideal for limit switches
Included in delivery

3. Screw connection



4 x M6/M4 (optional)

Directions for installation: The end blocks should not be used as a mechanical stop under any circumstances. A minimum spacing of 10 mm should be provided on both sides. The safety distance provided at both sides of the guide carriage can be reduced provided that it is ensured that the housings of the drive and end blocks do not

collide with the mechanical parts. The iglus® staff would be glad to provide you with more information on the fastening and connecting of the belt drive.

Call 888-803-1895, or write to sales@igus.com

Motor flange



The motor flange can be fastened onto the end block with four screws. Different types of motor flanges are available.
Item no. SAX-104005

The DryLin® ZLW belt drive is also available with hand crank.

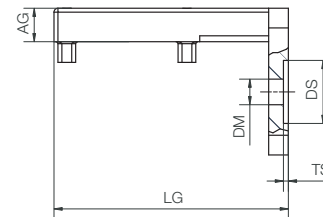
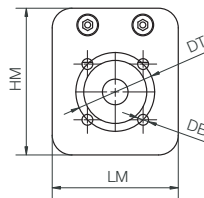
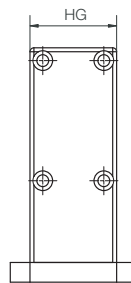

Dimensions in mm

For ZLW-0630

	Base plate			Motor mounting plate						
	LG	HG	AG	HM	LM	DT	DM	DS	TS	DB
NEMA170630	110.5	28	12	53	44	43.8	6	22	2.5	3.5
NEMA230630	120.5	28	12	59	56	66.7	10	38.1	2.5	4.5

For ZLW-1040

	Base plate			Motor mounting plate						
	LG	HG	AG	HM	LM	DT	DM	DS	TS	DB
NEMA171040	138	44	17	63	44	43.8	6	22	2.5	3.5
NEMA231040	138	44	17	70.7	54.6	66.7	14	38.1	2.5	4.5
NEMA341040	138	44	17	85	85	99.0	16	73	2.5	6.5

DryLin®
Linear Slide Tables

PDF: www.igus.com/iglide-pdfs
CAD: www.igus.com/iglide-CAD
RoHS info: www.igus.com/RoHS



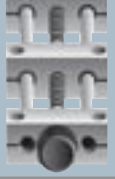

DryLin® Linear Slide Tables

DryLin®
Linear Slide Tables

Telephone 1-800-521-2747
Fax 1-401-438-7270

Internet: <http://www.igus.com>
email: sales@igus.com
QuickSpec: <http://www.igus.com/iglide-quickspec>

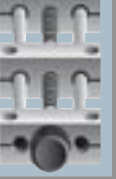

Navigation icons: a plus sign (+), a vertical bar (|), an information icon (i), a unit selector with 'inch' and 'mm' options, and a minus sign (-).

DryLin® Linear Slide Tables

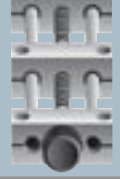

Internet: <http://www.igus.com>
email: sales@igus.com
QuickSpec: <http://www.igus.com/iglide-quickspec>

Telephone 1-800-521-2747
Fax 1-401-438-7270

DryLin®
Linear Slide Tables



DryLin[®] TR Lead Screw Drives



DryLin® TR Lead Screw Drives

Lead screw drives convert a rotary motion into a linear motion. DryLin® TR Lead Screw Drives are based on oil-free self lubricating plastic nuts offering long life. Since the lead screw system does not require lubrication they are ideal for sensitive laboratory and hospital equipment as well as very dirty or corrosive environments.

Product Range

- 20 dimensions
- Up to 5 nut geometries

Special Features



Cleanroom certified -
IPA Fraunhofer



ESD compatible
(electrostatic discharge)



Free of toxins -
RoHS 2002/95/EC

Technical Data

Nuts:

Maintenance-free polymer

Materials:

- iglide® L280
- iglide® J

Temperatures

-20°F to +194°F

(-4 °C to +90 °C)

Optional Features

- Anti backlash
- Self-locking
- High speed pitch

Usage Guidelines



- Dry-running, no lubrication is required
- When dirt/dust resistance is necessary
- If corrosion resistance is required



- If positioning accuracy below 10 µm (0.0004")
- For dynamic load applications
- For required efficiency higher than the 50%

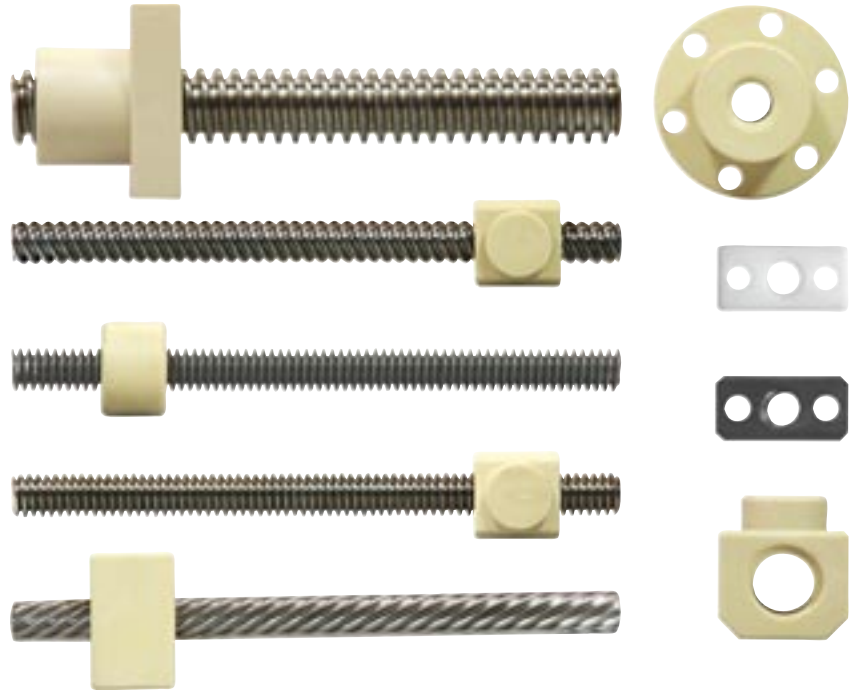

Advantages of DryLin® TR Lead Screw Drives

- Best resistance to binding
- Quiet operation
- Trapezoidal lead screws available in steel, stainless steel and anodized aluminum (on request)
- Left-handed lead screw nuts on request

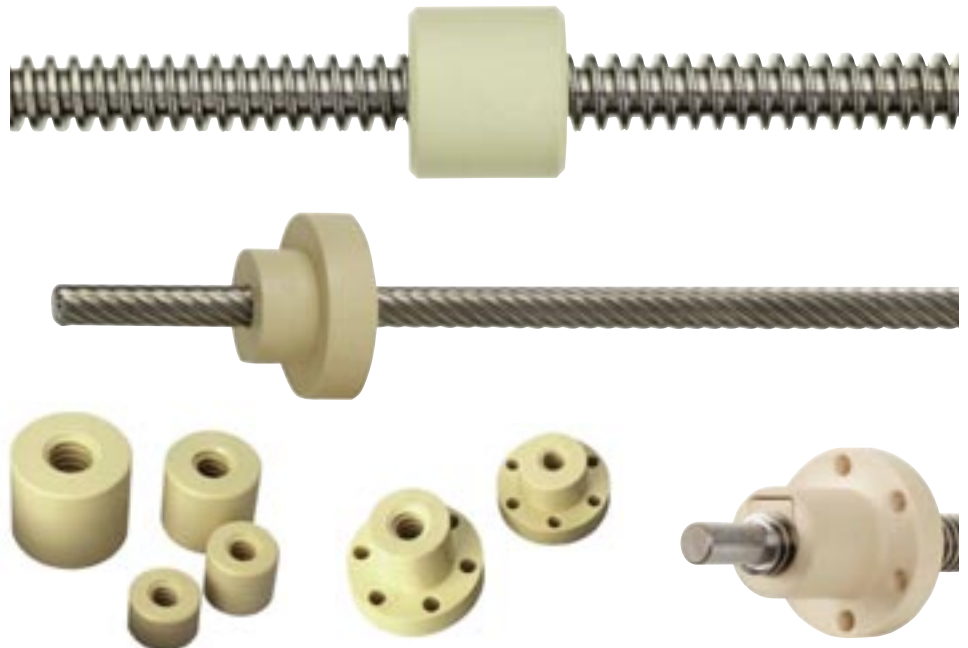

Sleeve

Flange

Anti-backlash



Typical industries and applications

- Lab/medical equipment
- Packaging
- Format adjustment
- Architectural
- Aircraft interiors
- Storage retrieval



Two component mixing unit

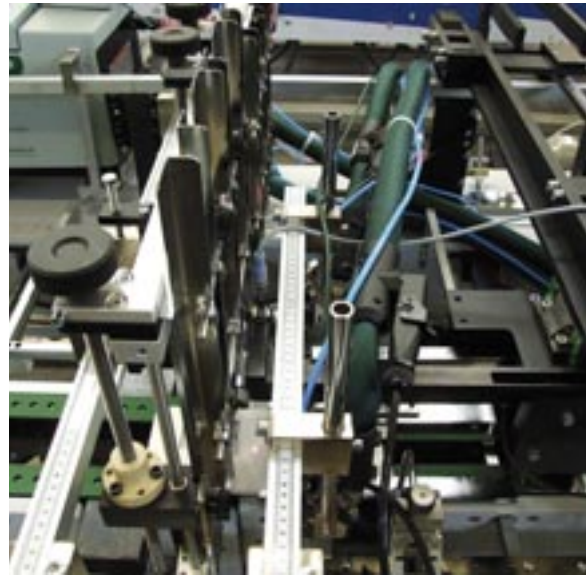

Inspection machinery



Commercial can opener

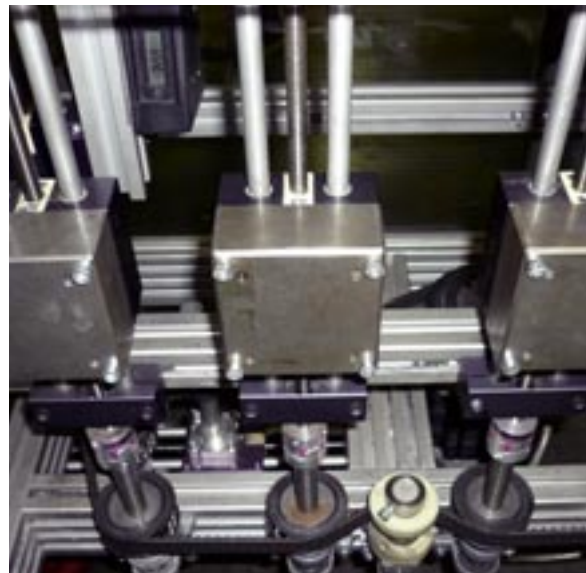

Height adjustment



DryLin® TR Lead Screw Drives Technical Data

DryLin®
Lead Screw Drives

Telephone 1-800-521-2747
Fax 1-401-438-7270

Internet: <http://www.igus.com>
email: sales@igus.com
QuickSpec: <http://www.igus.com/iglide-quickspec>

DryLin® lead screw nuts outperform bronze and other polymer lead screw nuts in many applications, and do not require messy lubrication or continuous maintenance. This makes them particularly ideal for applications in sensitive lab, food, or electronics manufacturing, as well as resistant to dirty environments.

Wet environments

For highly humid applications we recommend nuts made from iglide® J material as it has a very low level of moisture absorption. For applications with extremely critical precision requirements in conjunction with very high heat or humidity please contact igus® for design guidance.

Specifications

DryLin® TR lead screw systems are made in accordance with DIN 103, and checked through the use of plug gauges.

Performance vs. Simple Plastics

igus® has developed plastic bearing compounds for over 50 years. These products have been created to replace metals as well as simple plastic parts. Solid polymer lubricants engineered into the base plastics embed themselves into the microfinish of the lead screw — resulting in a low-friction dry-running system. The over 5000 tests we perform each year results in lower wear and friction plastics.

HTS and SLW

igus® also offers lead screw systems integrated into our HTS and SLW lead screw tables, pre-assembled and cut-to-length from stock. Please refer to Section 30 for more details.



SLW
Page
30.10

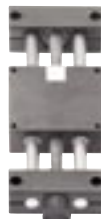

HTS
Page
30.17

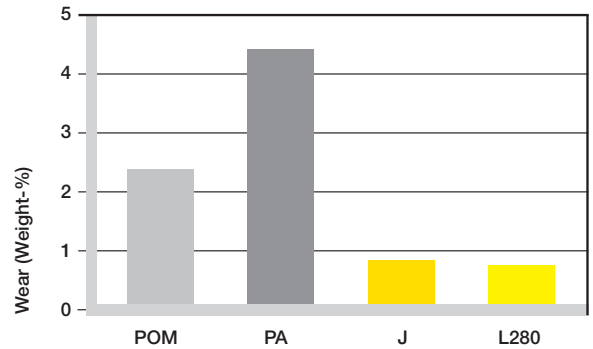

Wear test with 100N (45 lbf) axial load using a cold rolled screw

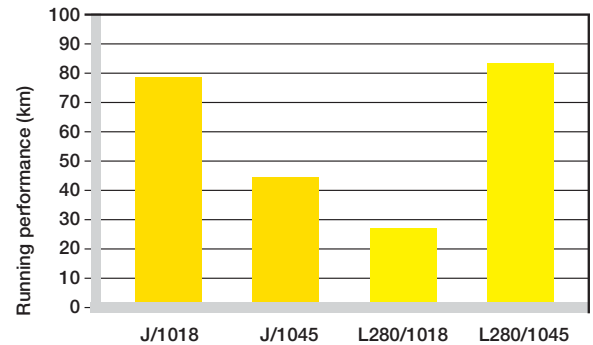

Wear test with 200N (90 lbf) axial load and 50% duty cycle

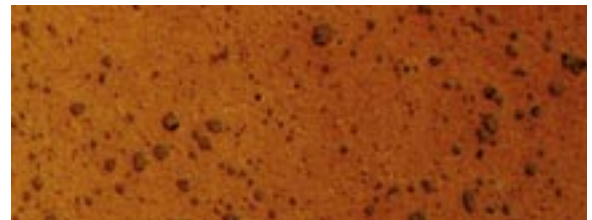

Base plastics without reinforcing materials with solid lubricants, magnified 200 times, dyed.

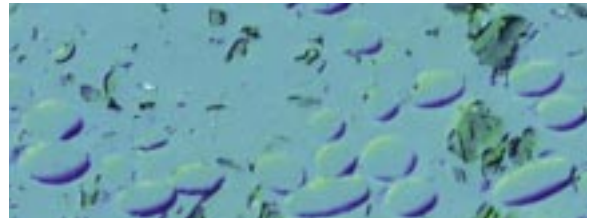

Base plastics with fibers and solid lubricants, magnified 200 times, dyed



Required (running surface)

$$A_e = F_{axial} / p_{permissible} \quad (\text{mm}^2)$$

Selection of the thread size and determination of the effective surface pressure

$$p_{eff} = F_{axial} / A_{e\ eff} \quad (\text{MPa})$$

Permissible sliding speed

$$v_{slide} = p \times v_{max} / p_{eff} \quad (\text{m/s})$$

Maximum permissible RPM

$$N = v_{slide} \times 1.000 \times 60 / (\pi \times d1) \quad (\text{1/min})$$

Feed speed

$$v_{feed} = n \times P / 60.000 \quad (\text{m/s})$$

F_{axial}	Axial force
$p_{permissible}$	Max. permissible surface pressure 5 MPa (iglide® L280) Max. permissible surface pressure 4 MPa (iglide® J)
p_{eff}	Effective surface pressure on a specific thread size
$A_{e\ eff}$	Percentage of surface contact area of the selected nut
P	Pitch
$d1$	Diameter

Calculation of trapezoidal thread loads

Trapezoidal Lead Screw Evaluation

The load capacity of these plastic trapezoidal lead screws nuts depends on the surface pressure, the surface speed and the resultant temperature. The temperature behavior is additionally influenced by the duty cycle as well as the spindle material and its specific heat conductivity. The surface pressure of the DryLin® trapezoidal lead screw nuts should not exceed the value of 5 MPa on a long term. Reference values when using DryLin® plastic nuts without lubrication (with stroke 300 mm)

On time OT	PV-value _{max} (MPa • m/s)
100%	0.08
50%	0.2
10%	0.3

With the PV value and the surface bearing length ratio specified in the dimension tables, the permissible surface speed and the feed rate can be determined for each thread size.





DryLin® TR Lead Screw Drives Trapezoidal Threaded Spindle PTGSG

DryLin®
Lead Screw Drives

Telephone 1-800-521-2747
Fax 1-401-438-7270

Internet: <http://www.igus.com>
email: sales@igus.com
QuickSpec: <http://www.igus.com/iglide-quickspec>

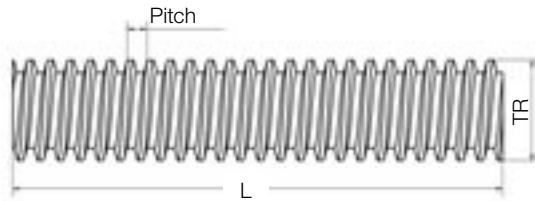

Part number structure

PTGSG-10 x 2-01-R-ES-1000

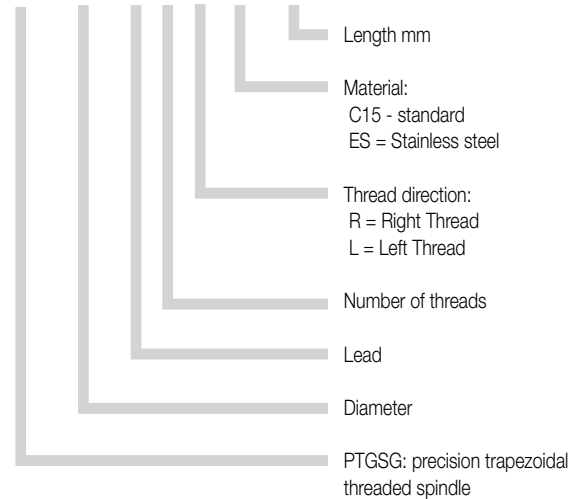

Dimensions (mm)

Part No.	Thread	Diameter	Lead	Max. Length (mm)
PTGSG-08x1.5-R or -L	8 x 1.5	8	1.5	1,000
PTGSG-10x2-R or -L	10 x 2	10	2	1,000
PTGSG-10x3-R or -L	10 x 3	10	3	1,000
PTGSG-12x3-R or -L	12 x 3	12	3	2,000
PTGSG-14x4-R or -L	14 x 4	14	4	3,000
PTGSG-16x4-R or -L	16 x 4	16	4	3,000
PTGSG-18x4-R or -L	18 x 4	18	4	3,000
PTGSG-20x4-R or -L	20 x 4	20	4	3,000
PTGSG-24x5-R or -L	24 x 5	24	5	3,000
PTGSG-26x5-R or -L	26 x 5	26	5	3,000
PTGSG-28x5-R or -L	28 x 5	28	5	3,000
PTGSG-30x6-R or -L	30 x 6	30	6	3,000
PTGSG-36x6-R or -L	36 x 6	36	6	3,000
PTGSG-40x7-R or -L	40 x 7	40	7	3,000
PTGSG-50x8-R or -L	50 x 8	50	8	3,000

DryLin® precision spindles are made of predominantly cold-rolled 1018 material.

Alternatively stainless steel or hard-coated aluminum are available on request.

Left-right and alternative thread shapes are available on request.

Pitch deviation 0.1/300 mm, straightness 0.3/300 mm

DryLin® TR Lead Screw Drives Trapezoidal Lead Screw Sleeve iglide® L280 Material

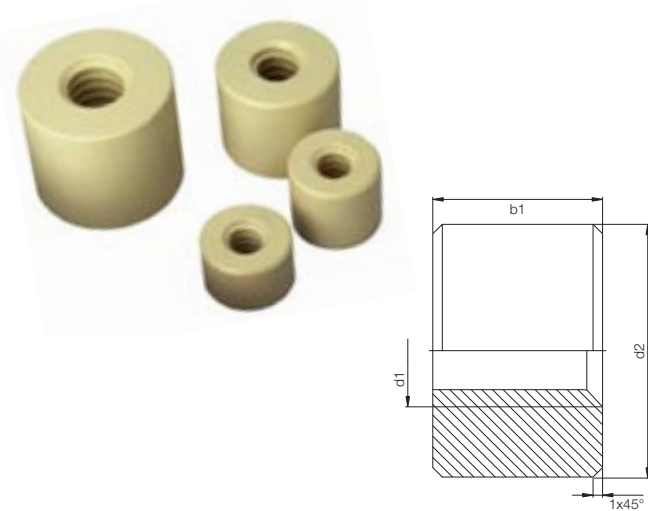

Part number structure

W S R M 22 15 TR 10x2

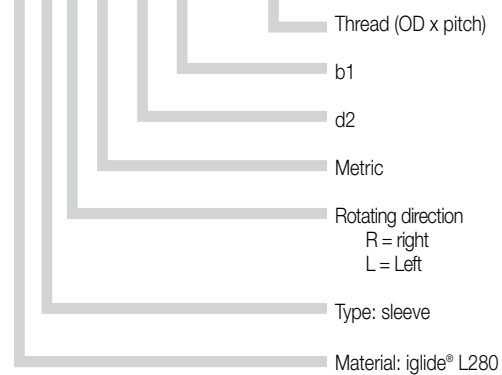

Dimensions (mm)

Part No.	Effective supporting surface (mm²)	d1	d2	b1	TR d1 x P	Max. static F axial (N)
WSRM2215TR10x2	212	10	22	15	TR 10 x 2	1060
WSRM2215TR10x3	200	10	22	15	TR 10 x 3	1000
WSRM2618TR12x3	296	12	26	18	TR 12 x 3	1480
WSRM3021TR14x4	396	14	30	21	TR 14 x 4	1980
WSRM3624TR16x2	564	16	36	24	TR 16 x 2	2820
WSRM3024TR16x4	526	16	30	24	TR 16 x 4	2630
WSRM3624TR16x4	526	16	36	24	TR 16 x 4	2830
WSRM3027TR18x4	678	18	30	27	TR 18 x 4	3390
WSRM4027TR18x4	678	18	40	27	TR 18 x 4	3390
WSRM3025TR20x4	706	20	30	25	TR 20 x 4	3530
WSRM4530TR20x4	848	20	45	30	TR 20 x 4	4240
WSRM5036TR24x5	1214	24	50	36	TR 24 x 5	6070
WSRM5039TR26x5	1438	26	50	39	TR 26 x 5	7190
WSRM6042TR28x5	1680	28	60	42	TR 28 x 5	8400
WSRM6045TR30x6	1906	30	60	45	TR 30 x 6	9530

Long Version

WSRM2220TR10x2	282	10	22	20	TR 10 x 2	1410
WSRM2220TR10x3	266	10	22	20	TR 10 x 3	1330
WSRM2624TR12x3	394	12	26	24	TR 12 x 3	1970
WSRM3028TR14x4	526	14	30	28	TR 14 x 4	2630
WSRM3632TR16x2	702	16	36	32	TR 16 x 2	3510
WSRM3632TR16x4	752	16	36	32	TR 16 x 4	3760
WSRM4036TR18x4	904	18	40	36	TR 18 x 4	4520
WSRM4540TR20x4	1130	20	45	40	TR 20 x 4	5650
WSRM5048TR24x5	1620	24	50	48	TR 24 x 5	8100
WSRM5052TR26x5	1918	26	50	52	TR 26 x 5	9590
WSRM6056TR28x5	2240	28	60	56	TR 28 x 5	11200
WSRM6060TR30x6	2542	30	60	60	TR 30 x 6	12710

DryLin®
Lead Screw Drives

PDF: www.igus.com/iglide-pdfs
CAD: www.igus.com/iglide-CAD
RoHS info: www.igus.com/RoHS





DryLin® TR Lead Screw Drives

Trapezoidal Lead Screw - Sleeve

iglide® J Material

DryLin®
Lead Screw Drives

Telephone 1-800-521-2747
Fax 1-401-438-7270

Internet: <http://www.igus.com>
email: sales@igus.com
QuickSpec: <http://www.igus.com/iglide-quickspec>

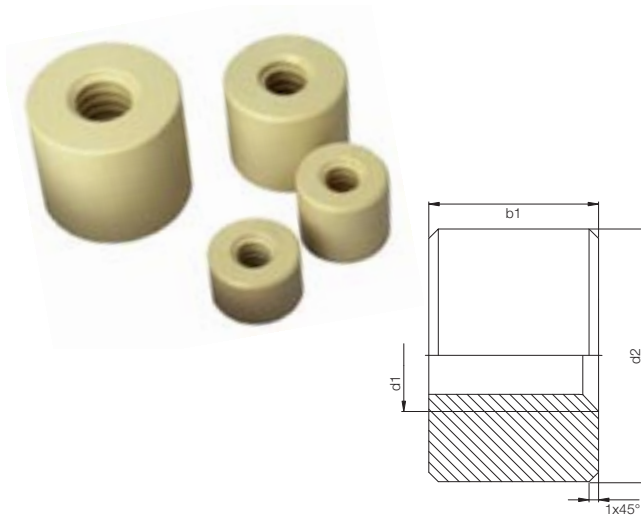

Part number structure

J S R M 22 15 TR 10x2

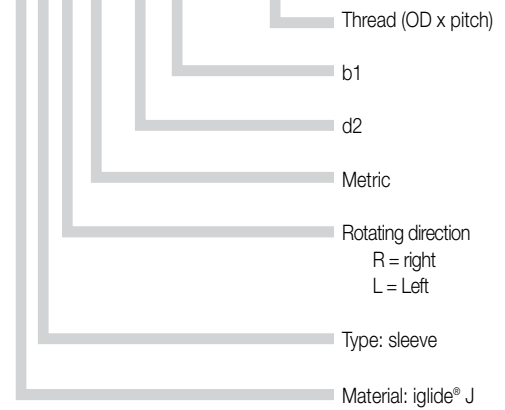

Dimensions (mm)

Part No.	Effective supporting surface (mm²)	d1	d2	b1	TR d1 x P	Max. static F axial (N)
JSRM1812T8x1.5	136	8	18	12	TR 8 X 1.5	400
JSRM2220TR10x2	282	10	22	20	TR 10 x 2	1128
JSRM2220TR10x3	266	10	22	20	TR 10 x 3	1064
JSRM2624TR12x3	394	12	26	24	TR 12 x 3	1576
JSRM3028TR14x4	526	14	30	28	TR 14 x 4	2104
JSRM3632TR16x2	702	16	36	32	TR 16 x 2	2808
JSRM3632TR16x4	752	16	36	32	TR 16 x 4	3008
JSRM4036TR18x4	904	18	40	36	TR 18 x 4	3616
JSRM4540TR20x4	1130	20	45	40	TR 20 x 4	4520
JSRM5048TR24x5	1620	24	50	48	TR 24 x 5	6480
JSRM5052TR26x5	1918	26	50	52	TR 26 x 5	7672
JSRM6056TR28x5	2240	28	60	56	TR 28 x 5	8960
JSRM6060TR30x6	2542	30	60	60	TR 30 x 6	10168
JSRM7572TR36X6	3732	36	75	72	TR 36 x 6	12219
JSRM7680TR40X7	2542	40	76	80	TR 40 x 7	14270
JSRM90100T50X8	7225	50	90	100	TR 50 x 7	16320

DryLin® TR Lead Screw Drives Trapezoidal Lead Screw - Sleeve iglide® L280 or iglide® J Material

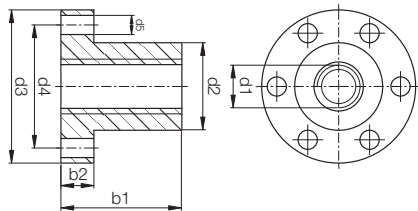

Part number structure

W F R M 22 15 TR 10x2

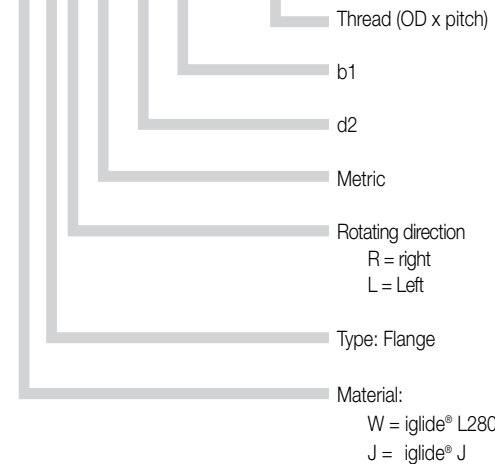

Dimensions (mm)

Part No. Flange	Effective supporting surface (mm ²)	d1	d2	d3	d4	d5*	b1	b2	TR d1 x P	Max. static F axial (N)
WFRM2525TR10x2	352	10	25	42	34	5	25	10	TR 10 x 2	1760
WFRM2835TR12x3	576	12	28	48	38	6	35	12	TR 12 x 3	2880
WFRM2835TR14x4	658	14	28	48	38	6	35	12	TR 14 x 4	3290
WFRM2835TR16x4	768	16	28	48	38	6	35	12	TR 16 x 4	3840
WFRM2835TR18x4	878	18	28	48	38	6	35	12	TR 18 x 4	4390
WFRM3244TR20x4	1242	20	32	55	45	7	44	12	TR 20 x 4	6210
WFRM3244TR24x5	1484	24	32	55	45	7	44	12	TR 24 x 5	7420
WFRM3846TR26x5	1696	26	38	62	50	7	46	14	TR 26 x 5	8480
WFRM3846TR28x5	1840	28	38	62	50	7	46	14	TR 28 x 5	9200
WFRM3846TR30x6	1948	30	38	62	50	7	46	14	TR 30 x 6	9740

* For 2.5 Nm maximum torque for fasteners. Liquid adhesive for thread locknuts recommended for mounting bolts

Part No. Flange	Effective supporting surface (mm ²)	d1	d2	d3	d4	d5*	b1	b2	TR d1 x P	Max. static F axial (N)
JFRM2525TR10x2	352	10	25	42	34	5	25	10	TR 10 x 2	1408
JFRM2835TR12x3	576	12	28	48	38	6	35	12	TR 12 x 3	2304
JFRM2835TR14x4	658	14	28	48	38	6	35	12	TR 14 x 4	2632
JFRM2835TR16x4	768	16	28	48	38	6	35	12	TR 16 x 4	3072
JFRM2835TR18x4	878	18	28	48	38	6	35	12	TR 18 x 4	3512
JFRM3244TR20x4	1242	20	32	55	45	7	44	12	TR 20 x 4	4968
JFRM3244TR24x5	1484	24	32	55	45	7	44	12	TR 24 x 5	5936
JFRM3846TR26x5	1696	26	38	62	50	7	46	14	TR 26 x 5	6320
JFRM3846TR28x5	1840	28	38	62	50	7	46	14	TR 28 x 5	4560
JFRM3846TR30x6	1948	30	38	62	50	7	46	14	TR 30 x 6	3576**

* For 2.5 Nm maximum torque for fasteners. Liquid adhesive for thread locknuts recommended for mounting bolts

**Reduced axial load through narrow flange shapes; special forms on request

DryLin®
Lead Screw Drives

PDF: www.igus.com/iglide-pdfs
CAD: www.igus.com/iglide-CAD
RoHS info: www.igus.com/RoHS





DryLin® TR Lead Screw Drives

Anti-backlash thread nuts - Sleeve or Flange

iglide® J material

DryLin®
Lead Screw Drives

Telephone 1-800-521-2747
Fax 1-401-438-7270

Internet: <http://www.igus.com>
email: sales@igus.com
QuickSpec: <http://www.igus.com/iglide-quickspec>

Backlash refers to the play at direction reversal, which is caused by the axial clearance between the nut and the screw. Anti-backlash nuts constantly reduce this clearance during the entire lifetime (within the permissible wear).



Flange model shown

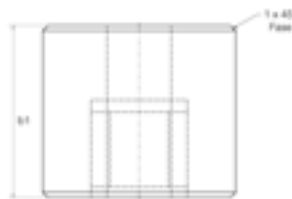

Part number structure

J S R 22 20 A 10 x 2

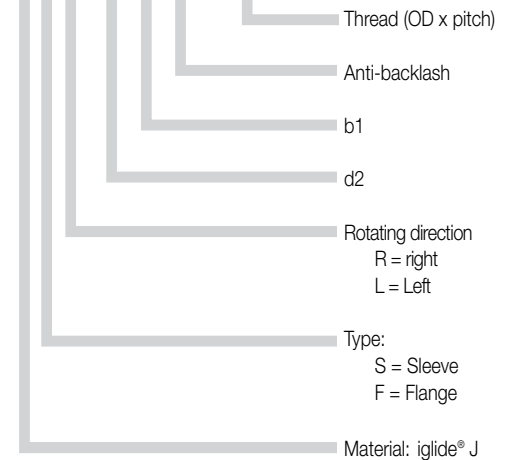

Dimensions (mm)

Part No.	d1	d2	b1	TR d1 x P	Max. static F axial (N)
Sleeve					
JSR2220A10x2	10	20	20	TR 10 x 2	840
JSR4036A18x4	12	40	36	TR 18 x 4	2700
JSR5048A24x5	14	50	48	TR 24 x 5	4800



Dimensions (mm)

Part No.	d1	d2	d3	d4	d5	b1	b2	TR d1 x P	Max. static F axial (N)
Flange									
JFR2525A10x2	10	25	42	34	5	25	10	TR 10 x 2	1160
JFR2835A18x4	12	28	48	38	6	35	12	TR 18 x 4	2890
JFR3244A24x5	14	32	55	45	7	44	12	TR 24 x 5	4890

DryLin® TR Lead Screw Drives

Lead screws and nuts with high helix thread



DryLin®
Lead Screw Drives



High helix lead screw

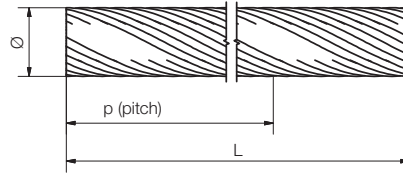

Dimensions (mm)

Part No.	Diameter	Pitch	Max. Length (mm)	Material
PTGSG10x12RES-length in mm	10	12	2000	420 Stainless
PTGSG10x12RES-length in mm	10	50	2000	420 Stainless
PTGSG10x12RES-length in mm	18	100	2000	420 Stainless

Round nut, sleeve

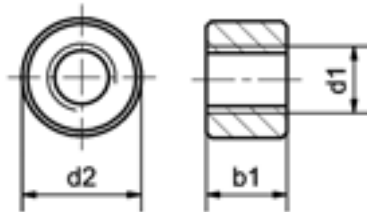

Dimensions (mm)

Part No.	Diameter	Pitch	Max. Length (mm)	Material
JSR2215T10x12	10	12	2000	420 Stainless
JSR2215T10x50	10	50	2000	420 Stainless
JSR3027T18x100	18	100	2000	420 Stainless

Nuts with flange

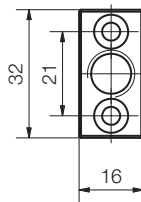

HTS1210SM10x12
HTS1210SM10x50

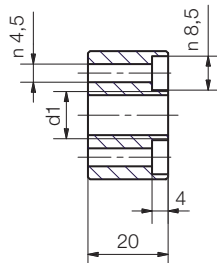

HTS2018SM
To attend: not symmetrical

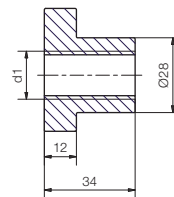
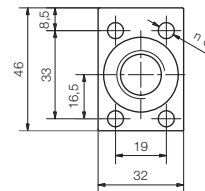

Dimensions (mm)

Part No.	d1	Pitch	Material
HTS2010SM10x12	10	12	iglide® J
HTS2010SM10x50	10	50	iglide® J
HTS2018SM	18	100	iglide® J

PDF: www.igus.com/iglide-pdfs
CAD: www.igus.com/iglide-CAD
RoHS info: www.igus.com/RoHS





DryLin® TR Lead Screw Drives

Lead screw end blocks, fixed and floating

DryLin®
Lead Screw Drives

Telephone 1-800-521-2747
Fax 1-401-438-7270

Internet: <http://www.igus.com>
email: sales@igus.com
QuickSpec: <http://www.igus.com/iglide-quickspec>



Part number structure

SLS-10x2-LL

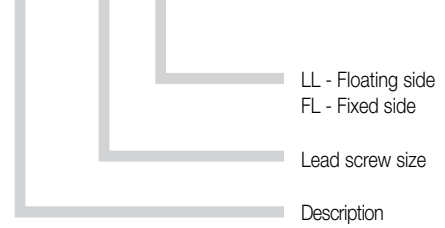

Fixed Side

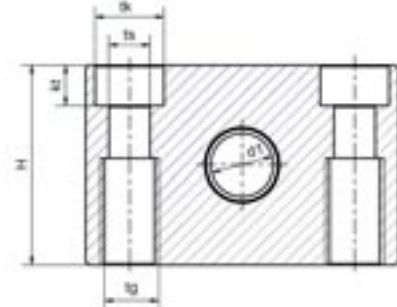
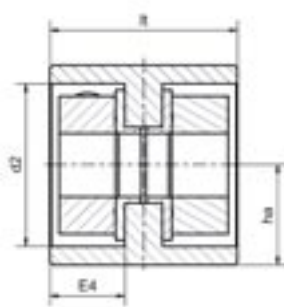
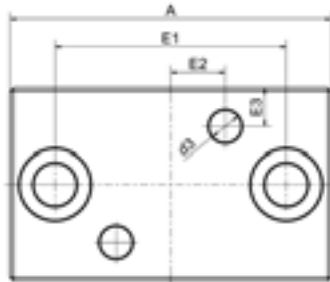

Floating Side

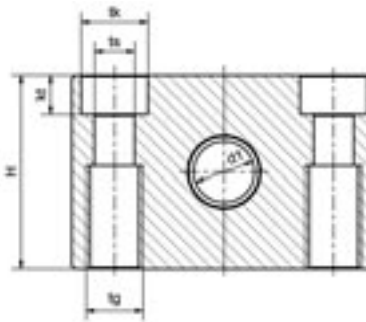
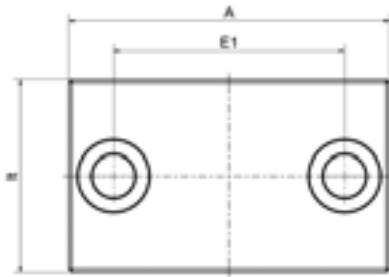

Dimensions (mm)

Part number	A	H	E1	E2	E3	E4	lt	tk	ts	tg	kt	d1	d2	d3	ha	Weight
	[mm]	[mm]	[mm]	[mm]	[mm]	[mm]	[mm]	[mm]	[mm]	[mm]	[mm]	[mm]	[mm]	[mm]	[mm]	[g]
SLS-10x2-LL	50	32	36	-	-	-	30	11	6.6	M8	6.5	10	-	-	16	115
SLS-10x2-FL	50	32	36	8.5	6	12	30	11	6.6	M8	6.5	10	26	5	16	88
SLS-18x4-LL	72	46	54	-	-	-	36	15	9	M10	8.6	12	-	-	23	295
SLS-18x4-FL	72	46	54	13.5	8	15	36	15	9	M10	8.6	18	42	6.6	23	205
SLS-24x5-LL	94	64	70	-	-	-	50	20	13.5	M16	13	14	-	-	32	725
SLS-24x5-FL	94	64	70	17.5	7.5	17	50	20	13.5	M16	13	24	52	8	32	525

DryLin® TR Lead Screw Drives

Quick-release nuts - fast forward



- For fast format adjustments
- Self braking design
- Lubrication-free
- Housing: AL anodized, iglide® J lead screw nut
- Robust and reliable
- Only recommended for horizontal applications
- Max. axial loads stat.: 200 N, dyn.: 50 N

Part number structure

F T R M-FF-10x2

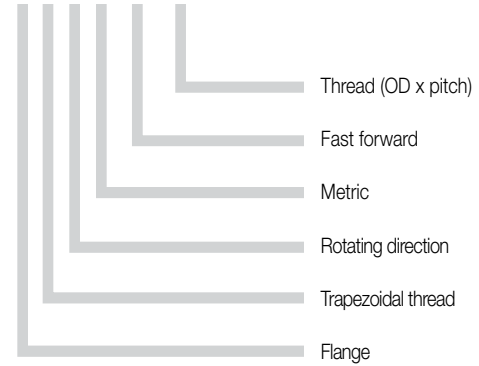

Quick release mechanism: A combination of accurate positioning and quick manual adjustment with trapezoidal lead screw nut. Simply press the square yellow section to release the nut from the thread, and move by hand to desired position.

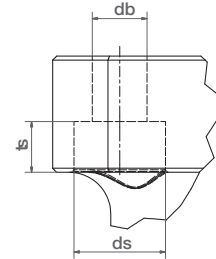
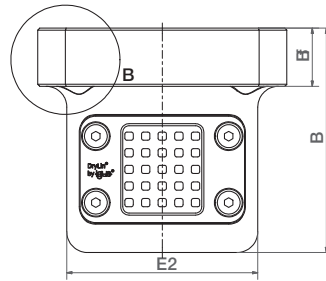
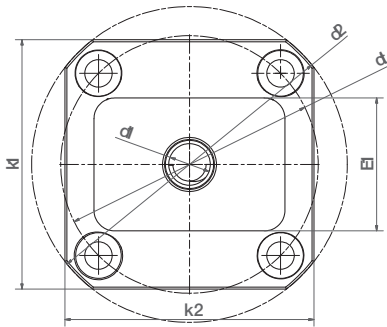

Dimensions (mm)

Part number	d1	d2	dt	B	Bf	ts	db	ds	k1	k2	E1	E2
FTRM-FF-10x2	TR-10x2	76	62	54	14	6.1	6.6	11	60	60	32	46

(Assembled lead screw system HTS-FF shown for example, see page 30.20)

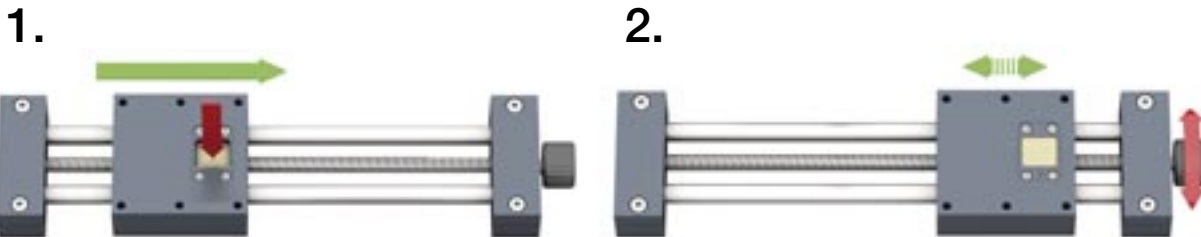

Press > disengage > move manually > click into place > fine-tune

DryLin®
Lead Screw Drives

PDF: www.igus.com/iglide-pdfs
CAD: www.igus.com/iglide-CAD
RoHS info: www.igus.com/RoHS





DryLin® TR Lead Screw Drives

DryLin®
Lead Screw Drives

Telephone 1-800-521-2747
Fax 1-401-438-7270

Internet: <http://www.igus.com>
email: sales@igus.com
QuickSpec: <http://www.igus.com/iglide-quickspec>



**DryLin® W, R, Shafting and
Slide Tables**

The oil-free, self-lubricating qualities of DryLin® linear guide systems are ideal for extreme applications: Saltwater in marine environments, caustic washdown in food processing/packaging equipment and chemicals in biotech/lab machinery to name a few.



Industries and application areas:

- Food processing
- Packaging
- Marine
- Biotech/lab automation
- Electroplating

DryLin® guides and iglide® plastics are well suited for use on stainless steel shafting, and are especially good in applications requiring 300-Series stainless steels, such as 304 and 316. Since the plastic plain bearings do not have the point-to-point contact on shafting that ball bearings do, they do not require more expensive corrosion-prone case-hardened stainless steels such as 440C.



Clean oil-free operation around food in this conveyor/baking application is achieved with DryLin®



DryLin® W is accredited to Cleanroom-set points and in use in this blister packaging machine

DryLin® Double rail and block bearing 316 Stainless Steel



DryLin®

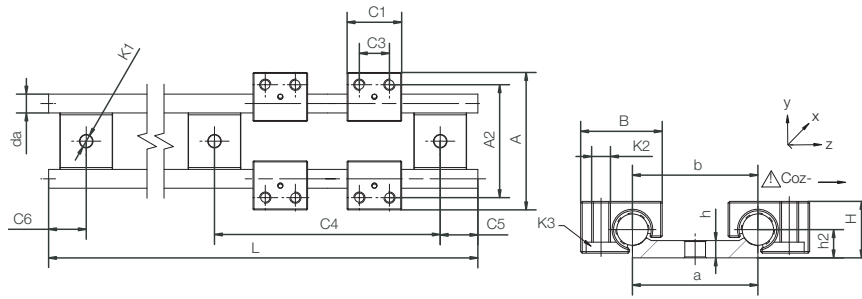

Material for carriage and shaft support 316
316L

DryLin® W guide rail, double, ø 10 mm

Part No.	Suitable bearing (Part No.)	Weight (kg/m)	da h9 (mm)	L Max. (mm)	a -0.3 (mm)	b (mm)	h (mm)	h2 (mm)
WS-10-40ESFG	WJUM-01-10-ES-FG	1.58	10	3000	40	40	5.5	9

Part No.	C4 (mm)	C5 Min. (mm)	C5 Max. (mm)	C6 Min. (mm)	C6 Max. (mm)	K1 for Screw DIN 912
WS-10-40ESFG	120	20	79.5	20	79.5	M6

PDF: www.igus.com/iglide-pdfs
CAD: www.igus.com/iglide-CAD
RoHS info: www.igus.com/RoHS



DryLin® W Stainless Carriage

Part No.	Weight (g)	H ±0,07 (mm)	B (mm)	C1 (mm)	C3 (mm)	A (mm)	A2 (mm)	K2 (mm)	K3 Countersunk- head screw	Stat. Load Capac. Coy (N)	Coz+ (N)	Coz- (N)
WJUM-01-10-ES-FG*	57	18	26	29	16	73	60	M6	M5	3800	3800	950

* alternative with TUMO-01-10 liners for high temperatures available up to 482°F (250°C)
Part number: WTUM-01-10ESFG

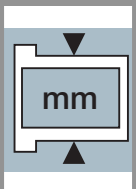

DryLin®
Stainless Steel

DryLin®
Stainless Steel

Telephone 1-800-521-2747
1-401-438-7270
Fax

Internet: <http://www.igus.com>
email: sales@igus.com
QuickSpec: <http://www.igus.com/iglide-quickspec>

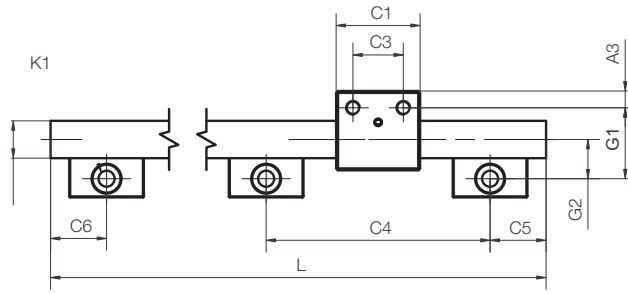

Material for carriage and shaft support 316
316L

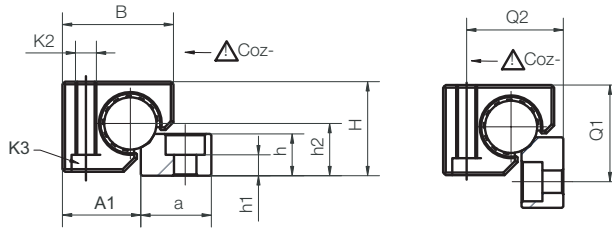

DryLin® W guide rail, single, ø 20 mm

Part No.	Suitable bearing [Part No.]	Weight [kg/m]	da h9 [mm]	L Max. [mm]	a -0.3 [mm]	h [mm]	h2 [mm]	G2 [mm]
WS-20-ESFG	WJUM-01-20-ES-FG	3,37	20	3000	27	16	20	21

Part No.	C4 [mm]	C5 Min. [mm]	C5 Max. [mm]	C6 Min. [mm]	C6 Max. [mm]	K1 for Screw DIN 912	h1 [mm]	ly [mm²]	lz [mm²]	Wby [mm³]	Wbz [mm³]
WS-20-ESFG	120	20	79.5	20	79.5	M8	8	7854	7854	785	785



DryLin® W Stainless Carriages

Part No.	Weight (g)	H ±0,07 (mm)	B (mm)	C1 (mm)	C3 (mm)	A (mm)	A2 (mm)	K2 (mm)	K3 Countersunk-head screw	Stat. Load Capac.		
										Coy (N)	Coz+ (N)	Coz- (N)
WJUM-01-10ESFG*	57	18	26	29	16	73	60	M6	M5	3800	3800	950

* alternative with TUMO-01-10 liners for high temperatures available up to 482°F (250°C)
Part number: WTUM-01-10ESFG

DryLin R Linear Plain Bearing Closed Stainless Steel Adapter 303



DryLin®



Special Properties

- Dimensionally equivalent to standard recirculating ball bearings
- For long-term temperatures up to 194°F (90°C)
- Can use iglide® T500 material liners for long term temperatures up to 482°F (250°C)
- Imperial dimension available upon request



DryLin®
Stainless Steel

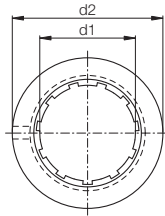
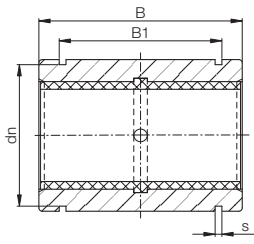

Dimensions (mm)

Part No.	d1	d2 h7	B h10	B1	s	dn
RJUM-01-12-ES	12	22	32	22.6	1.30	20.5
RJUM-01-16-ES	16	26	36	24.6	1.30	24.2
RJUM-01-20-ES	20	32	45	31.2	1.60	29.6
RJUM-01-25-ES	25	40	58	43.7	1.85	36.5
RJUM-01-30-ES	30	47	68	51.7	1.85	43.5

* according to igus® testing method ► Page 29.57

Load Data

Part No.	Shaft ∅ (mm)	Tolerance** Bearing Inner Diameter (mm)	F max. Dynamic** P = 5 MPa (N)	F max. Static** P = 35 MPa (N)	Weight (g)
RJUM-01-12-ES	12	+0.030 +0.088	960	6,720	60
RJUM-01-16-ES	16	+0.030 +0.088	1,440	10,080	84
RJUM-01-20-ES	20	+0.030 +0.091	2,250	15,750	147
RJUM-01-25-ES	25	+0.030 +0.091	3,625	25,375	324
RJUM-01-30-ES	30	+0.040 +0.110	5,100	35,700	486

PDF: www.igus.com/iglide-pdfs
CAD: www.igus.com/iglide-CAD
RoHS info: www.igus.com/RoHS



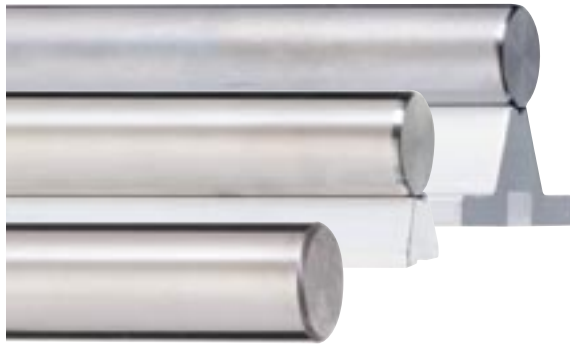

- Materials available
(440c) Hard stainless
(420c) Hard stainless
(304) Soft stainless
(316) Soft stainless
- Supported or unsupported shafts available
- Max undersupport rail length - 600 mm
- Symmetric hole pattern C5 = C6

Dimensions (mm) – Hardened Stainless (440c/1.4125)

Part No.	d ISO h6	Weight (kg/m)	Max. Length (mm)	Hardness Depth (mm)
EWM-06	06	0.222	3000	0.8
EWM-08	08	0.359	4000	0.9
EWM-10	10	0.617	4000	0.9
EWM-12	12	0.888	6000	1.0
EWM-16	16	1.578	6000	1.2
EWM-20	20	2.466	6000	1.6
EWM-25	25	3.853	6000	1.8
EWM-30	30	5.549	6000	2.0
EWM-40	40	9.865	6000	2.2
EWM-50	50	15.413	6000	2.4



Dimensions (mm) – Hardened Stainless (420c/1.4034)

Part No.	d ISO h6	Weight (kg/m)	Max. Length (mm)	Hardness Depth (mm)
EEWM-06	06	0.222	3000	0.8
EEWM-08	08	0.359	4000	0.9
EEWM-10	10	0.617	4000	0.9
EEWM-12	12	0.888	6000	1.0
EEWM-16	16	1.578	6000	1.2
EEWM-20	20	2.466	6000	1.6
EEWM-25	25	3.853	6000	1.8
EEWM-30	30	5.549	6000	2.0
EEWM-40	40	9.865	6000	2.2
EEWM-50	50	15.413	6000	2.4

Dimensions (mm) – Soft Stainless (304/1.4301)

Part No.	d ISO h9	Weight (kg/m)	Max. Length (mm)
EWMR-10	10	0.617	4000
EWMR-12	12	0.888	6000
EWMR-16	16	1.578	6000
EWMR-20	20	2.466	6000
EWMR-25	25	3.853	6000
EWMR-30	30	5.549	6000

Dimensions (mm) – Soft Stainless (316/1.4571)

Part No.	d ISO h9	Weight (kg/m)	Max. Length (mm)
EWMS-10	10	0.617	4000
EWMS-20	20	2.466	6000

DryLin® Stainless Steel Shafts, Supported Partial Aluminum Supports



DryLin®

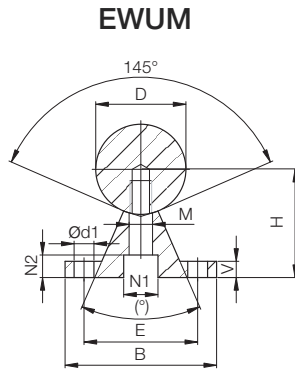

EWUMN

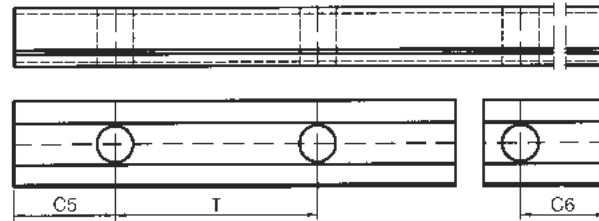
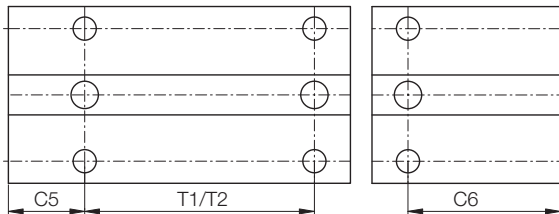
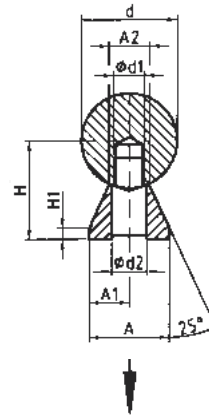

Dimensions (mm) – Supported Stainless (440c)

Part No.	D (mm) h6	B (mm)	H (mm) ±0.02	V (mm)	N1 (mm)	N2 (mm)	d1 (mm)	M (mm)	(°)	E (mm)	T1* (mm) ±0.15	C5/C6		T2 (mm) Standard	C5/C6		Weight (kg/m)
												min.	max. for T1		min.	max. for T2 Standard	
EWUM-12	12	40	22	5	8.0	5.0	4.5	5.8	50	29	75	20	57	120	20	79	1.75
EWUM-16	16	45	26	5	9.5	6.0	5.5	7.0	50	33	100	20	69	150	20	94	2.64
EWUM-20	20	52	32	6	11.0	6.5	6.6	8.3	50	37	100	20	69	150	20	94	3.97
EWUM-25	25	57	36	6	14.0	8.5	6.6	10.8	50	42	120	20	79	200	20	119	5.65
EWUM-30	30	69	42	7	17.0	10.5	9.0	11.0	50	51	150	20	94	200	20	119	7.93
EWUM-40	40	73	50	8	17.0	10.5	9.0	15.0	50	55	200	20	119	300	20	169	12.88
EWUM-50	50	84	60	9	19.0	12.5	11.0	19.0	46	63	200	20	119	300	20	169	19.60

* T1 optional, T2 standard

Dimensions (mm) – Narrow Supported Stainless (440c)

Part No.	d (mm) h6	H (mm)	H1 (mm) ±0.02	A (mm)	A1 (mm)	A2 (mm) ±0.02	d1	d2 (mm)	T (mm)	C5/C6 min.	C5/C6 max.	Weight (kg/m)
EWUMN-12	12	14.5	3	11	5.5	5.4	M4	4.5	75	20	57	1.62
EWUMN-16	16	18	3	14	7.0	7.0	M5	5.5	75	20	57	2.54
EWUMN-20	20	22	3	17	8.5	8.1	M6	6.6	75	20	57	3.81
EWUMN-25	25	26	3	21	10.5	10.3	M8	9.0	75	20	57	5.62
EWUMN-30	30	30	3	23	11.5	11.0	M10	11.0	100	20	69.5	7.63
EWUMN-40	40	39	4	30	15.0	15.0	M12	13.5	100	20	69.5	13.47
EWUMN-50	50	46	5	35	17.5	19.0	M14	15.5	100	20	69.5	20.31

Narrow supports are not assembled

DryLin®
Stainless Steel

PDF: www.igus.com/iglide-pdfs
CAD: www.igus.com/iglide-CAD
RoHS info: www.igus.com/RoHS

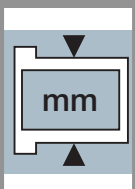

DryLin®
Stainless Steel

Telephone 1-800-521-2747
Fax 1-401-438-7270

Internet: <http://www.igus.com>
email: sales@igus.com
QuickSpec: <http://www.igus.com/iglide-quickspec>

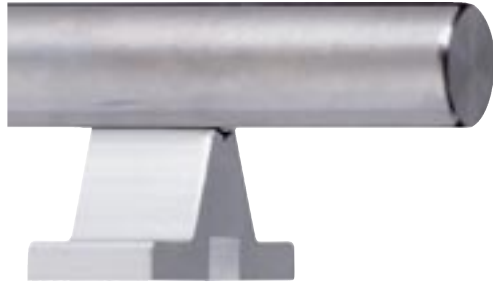

- Shaft support blocks for Ø 20 mm made of 300 Series stainless steel
- Connecting dimensions as standard full length aluminum supports
 - High corrosion and chemical resistance
 - Possible lengths
 - EWUM (440C) max. 6,000 mm
 - EWUMS (316L) max. 3,000 mm

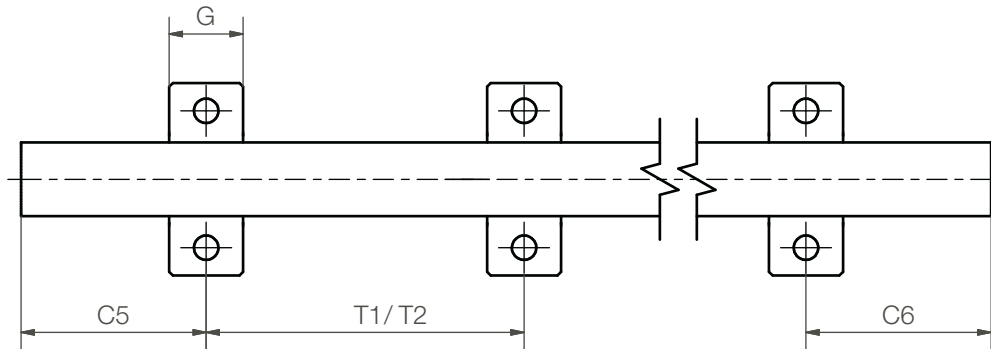
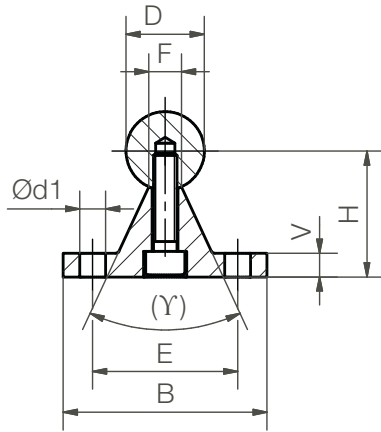

Dimensions (mm) – Supported Stainless

Part number	Shaft material	D h6	B	H ±0.02	V	d1	E	G	T1	C5/C6 for T1		T2	C5/C6 for T2	
										min.	max.		min.	max.
EWUM-ES-20	440C	20	52	32	6	6.6	37	20	100	20	69	150	20	94
EWUMS-ES-20	316L	20	52	32	6	6.6	37	20	100	20	69	150	20	94

DryLin® Linear Slide Tables - HTS SLW-ES - Stainless Steel



DryLin®



DryLin®
Stainless Steel



Special properties

- Stainless steel lead screw assembly with corrosion-resistant steel components
- Choice of bearing material:
 - iglide® J - standard
 - iglide® A180 - FDA
 - iglide® T500 - high temperature up to 482°F (250°C)
- Available accessories

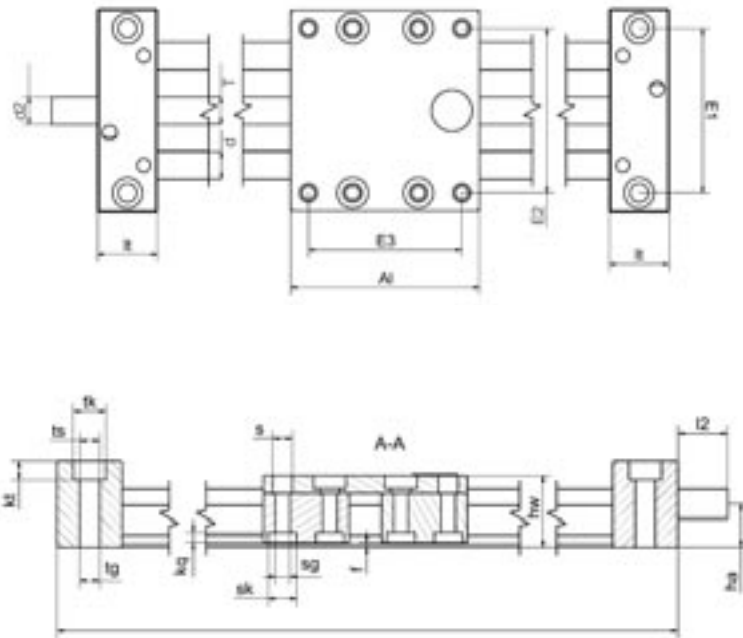
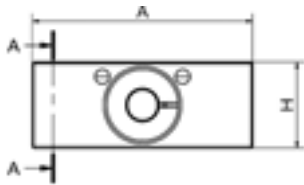

Dimensions (mm)

Part No.	A	A1**	H	E1	E2	E3	l	hw	f	lt	tk	ts	tg
	-0.3	-0.3		±0.15	±0.15	±0.15				-0.1			
SLW-ES-1040	74	100	29	60	60	87	113	24	1.5	22	11	6.8	M8
SLW-ES-2080	134	150	46	116	116	132	206	44	1.5	28	15	8.0	M10

Part No.	kt	s	sk	sg	kq	d	T	l2	d2	d2	ha
	±0.1								Standard	Optional	
SLW-ES-1040	6.4	6.6	9.5	M6	4.4	10	TR10x2	17	TR10x2*	6h9	14.5
SLW-ES-2080	8.6	9.0	14.0	M8	5.5	20	TR18x4	26	12 h9	-	23.0

* end of lead screw not machined/jourealed

** Carriages also available in 100, 150, 200 and 250 mm lengths

Length and weight (mm)

Part No.	Maximum stroke length	Linear travel/rev	Lead screw diameter	Shaft weight	Additional weight	Max. static load-bearing capacity	
	(mm)					(mm)	(kg)
SLW-ESJ-1040	750	1.25	10	0.2	0.08	50	200
SLW-ESX-1040	750	2	10	0.7	0.1	700	2800
SLW-ESA180-1040	750	2	10	0.9	0.2	700	2800
SLW-ESJ-2080	1000	4	18	1.5	0.3	1200	4600
SLW-ESA180-2080	1000	4	18	3.0	0.4	1600	6400

1N = .225 lbs

PDF: www.igus.com/iglide-pdfs
CAD: www.igus.com/iglide-CAD
RoHS info: www.igus.com/RoHS



DryLin®
Stainless Steel

Telephone 1-800-521-2747
Fax 1-401-438-7270

Internet: <http://www.igus.com>
email: sales@igus.com
QuickSpec: <http://www.igus.com/iglide-quickspec>



Based on the "hygienic design" idea, this version offers an easily cleaned solution. Screw connectors are designed easily accessible and the gap dimensions accordingly large for easy cleaning. The materials used are plastic and stainless steel.

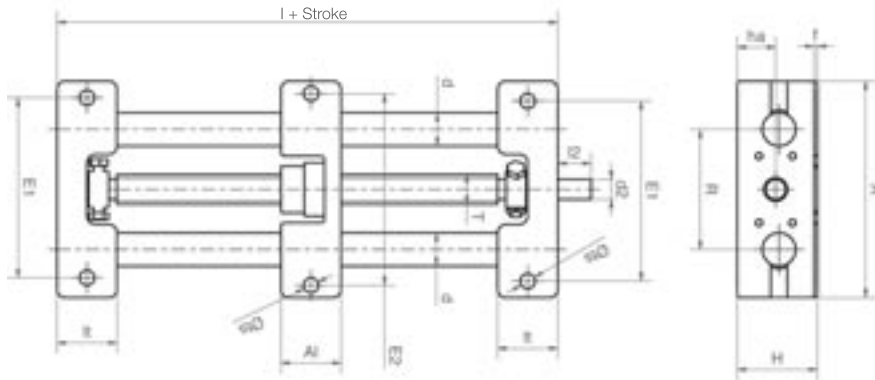

Dimensions (mm)

Part No.	A	Al	H	E1	E2	I	R	f	lt	ts	d	T	l2	d2	ha
HTSC-20-EWM-HYD	-0.3	-0.3	48	±0.15	±0.15	108	72	2	±0.1	9.0	20	tr18x4	26	12h9	23

DryLin® Linear Slide Tables

SLW - Compact XY-table, stainless steel



DryLin®



Special properties

- For manual adjustments
- Compact
- High torsional stability
- 100% lubrication-free
- Chemical and Corrosion-resistant
- Accessories optional

DryLin®
Stainless Steel

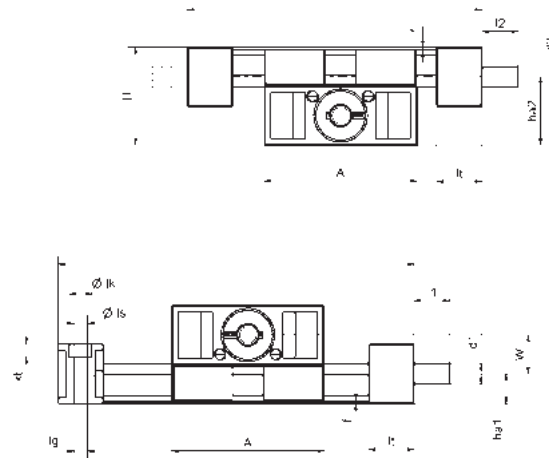
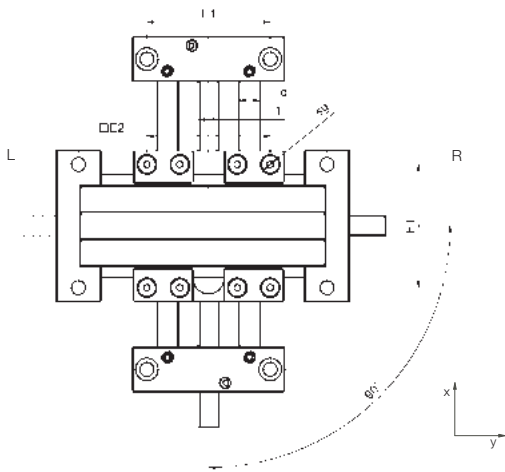

Dimensions (mm)

Part No.	A	H	E1	E2	Base Length	Base Length	f	lt	tk	ts	tg	kt
SLW-XY-ESJ-1040	-0.3 74	48	±0.15 60	±0.15 60	lx 118	ly 118	1.5	22	-0.1 11	6.6	M8	6.4

Part No.	sg	d	T	l1	d1	d1	l2	d2	d2	ha1	ha2	W
					Standard	Optional		Standard	Optional			
SLW-XY-ESJ-1040	M6	10	TR10x2	17	TR10x2	6h9	17	TR10x2	6h9	14.5	33.5	19

The handwheel on the y-axis can be ordered installed on the left or the right side.

Order example for left SLW-XY-ESJ-1040-AWM-200-300 for 200 mm stroke length on the x-axis and 300 mm on the y-axis.

Order example for left SLW-XY-ESJ-1040-AWM-R-200-300 for 200 mm stroke length on the x-axis and 300 mm on the y-axis.

PDF: www.igus.com/iglide-pdfs
CAD: www.igus.com/iglide-CAD
RoHS info: www.igus.com/RoHS





DryLin® Stainless Steel

DryLin®
Stainless Steel

Telephone 1-800-521-2747
Fax 1-401-438-7270

Internet: <http://www.igus.com>
email: sales@igus.com
QuickSpec: <http://www.igus.com/iglide-quickspec>

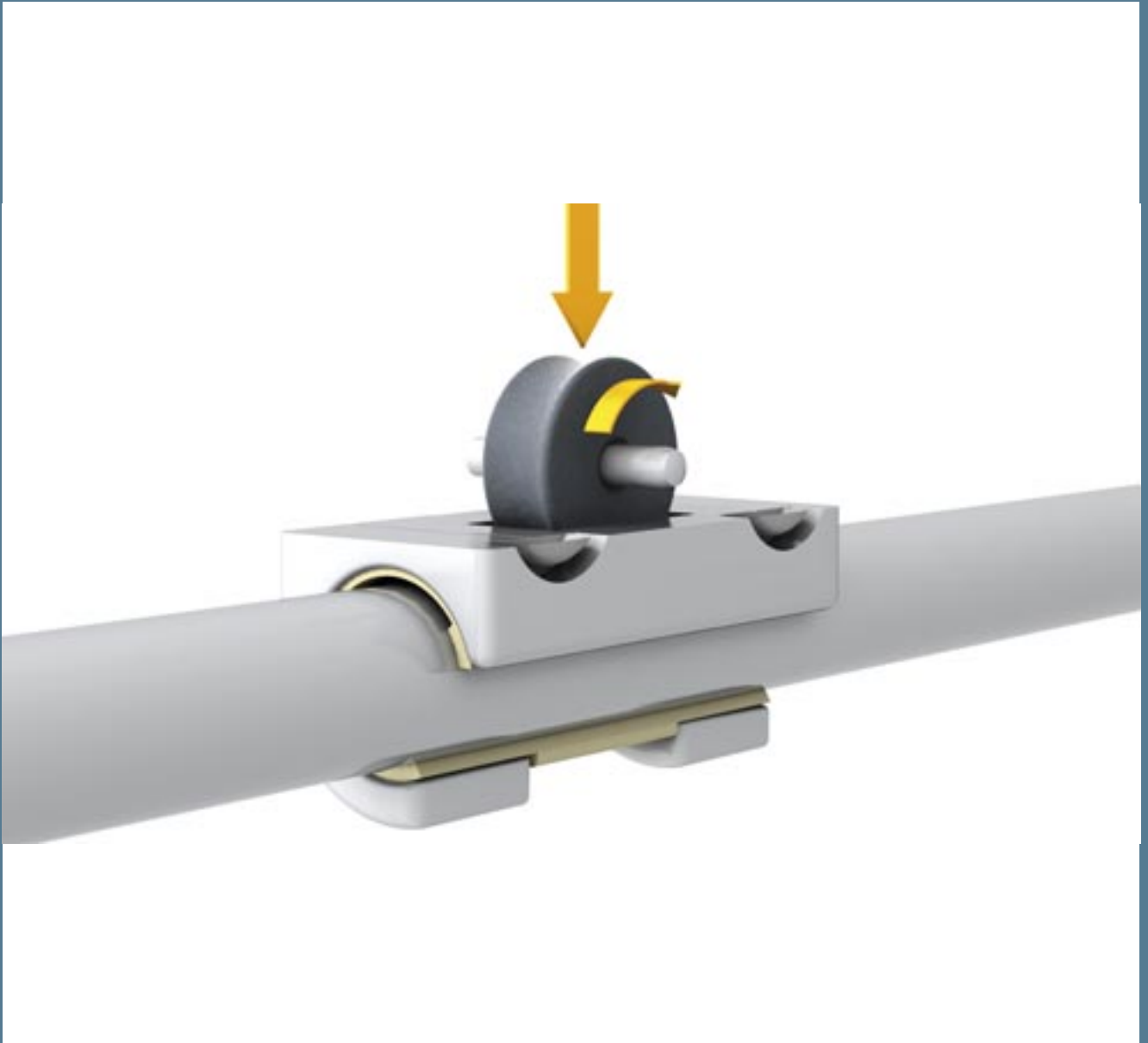

DryLin[®] Specialists

**DryLin® WJRM – Hybrid bearing**

WJRM - Rolling hybrid with reduced friction for hand powered and very low cycle applications.

**DryLin® NT – Telescopic System**

Lubrication-free solid polymer/aluminum guide for maximum extended lengths up to 1,200 mm.

**DryLin® NT - Telescopic Systems with Detent:**

- a) Precision detent with variable pitch (minimum pitch 10 mm)
- b) Detent in end and center positions

**DryLin® WKM – Digital measuring systems**

The DryLin® WKM measuring systems are battery powered. The integrated battery has a life of at least two years. The position value is displayed on a 5-digit LC display, and a magnetic strip is adhered to the guide rail.

**DryLin® WKMEX – Measuring system with signal line output**

Less space is required for the latest DryLin® WKMEX measuring device. The sensor head is integrated in the carriage (total height 36 mm). There are three sensor types available, two are compatible with a TTL Line Driver. We recommend igus® Energy Chain® series E2 micro or E-Z Chain for guiding the signal cable.

**DryLin® Q – Torque-resistant square guide**

DryLin® Q is compact, resistant to torques, and is ideal for handling small parts. Four liners made of iglide® J run on a hard anodized aluminum square tube. This unit is light weight, compact and 100% lubrication-free.

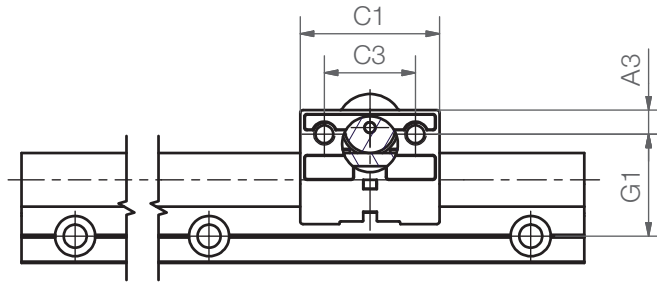

More information available on page 27.20

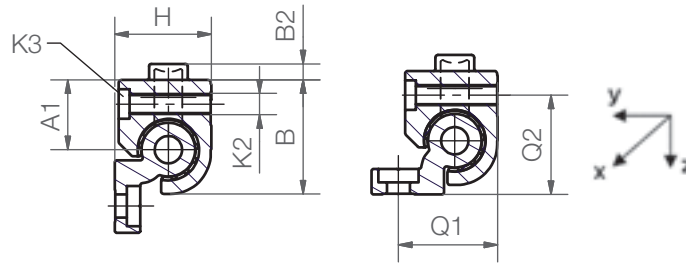

This installation position is not possible for combination of WJRM-01-10 with rail WS-10/WS-10-40/WS-10-80

Load Data and Dimensions

Part No.	Friction in +z direction	Weight (g)	B (mm)	B2 (mm)	C1 (mm)	C3 (mm)	G1 (mm)	A3 (mm)	A1 (mm)	K2 (mm)	K3 (N)	Q1 (mm)	Q2 (mm)
WJRM-01-10	<0.1	46	26	2.5	35	22	27	6.5	16.5	M6	M5	-	-
WJRM-01-16	<0.1	131	34.5	5	48	30	33	9	25	M8	M6	32	28
WJRM-01-20	<0.1	232	42.5	6	52	34	38	9	30	M8	M6	37	37

DryLin® Specialists

PDF: www.igus.com/iglide-pdfs
CAD: www.igus.com/iglide-CAD
RoHS info: www.igus.com/RoHS



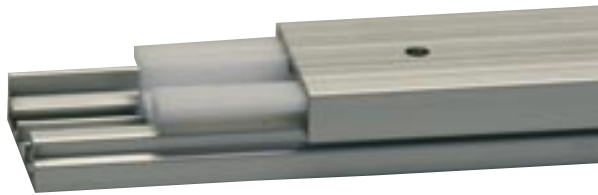

NT-35- "L" – Fully extended



NT-35- "L"- "A" – Partial extension

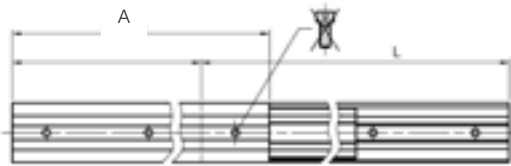

NT-35- "L"- "L+20" – Over extension

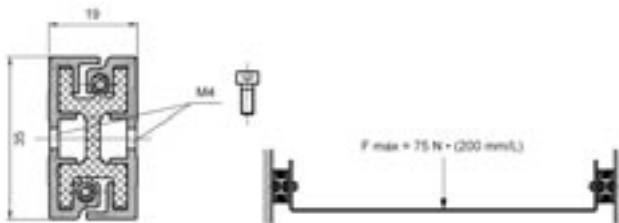
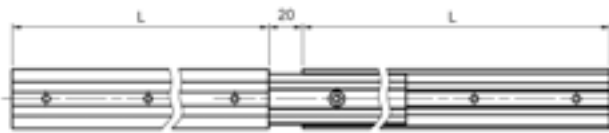

Dimensions (mm)

Part No.	b (mm)	H (mm)	L min. (mm)	L max. (mm)
NT-35-... mm	35	19	100	600

Special properties

- Solid plastic/aluminum design
- Low weight
- Corrosion-free, ideal for lab/hospital applications
- Maximum extension up to 1200 mm (Total length)

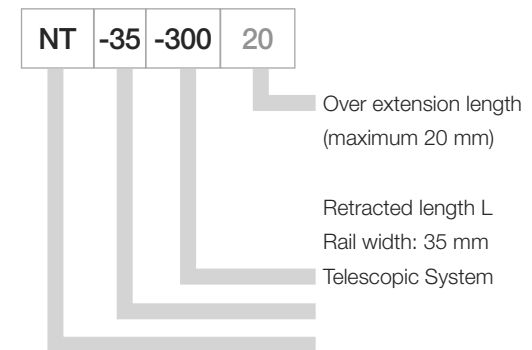
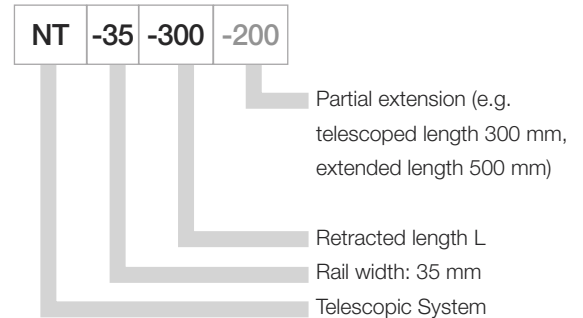
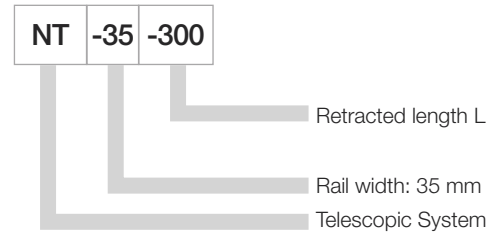

Recommendation:

F_{max} calculated using this formula allows for an easy manual use. The unit can take higher forces than this, but the required driving force will also be higher.

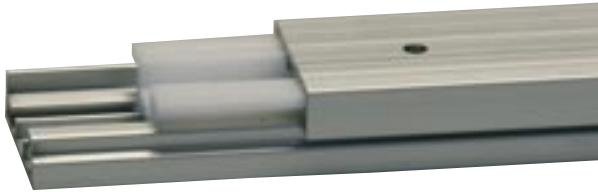

The proven DryLin® N telescopic system is now available with a locking mechanism.

There are two different versions:

- a) Detent in end and center positions
- b) Precision detent with variable pitch (minimum pitch 10 mm)

- Solid plastic/aluminum design
- Low weight
- Corrosion-free
- Maximum extension up to 1200 mm (Total length)

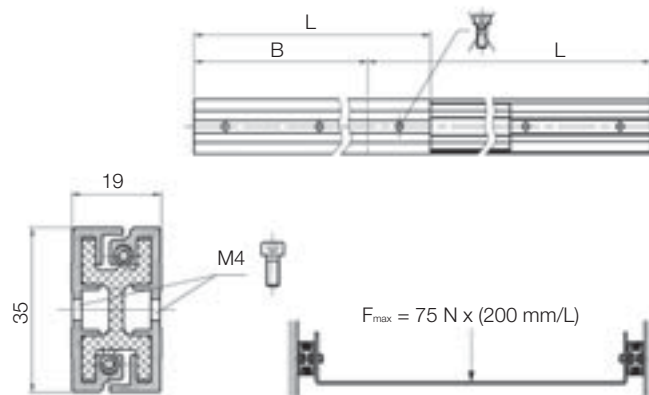
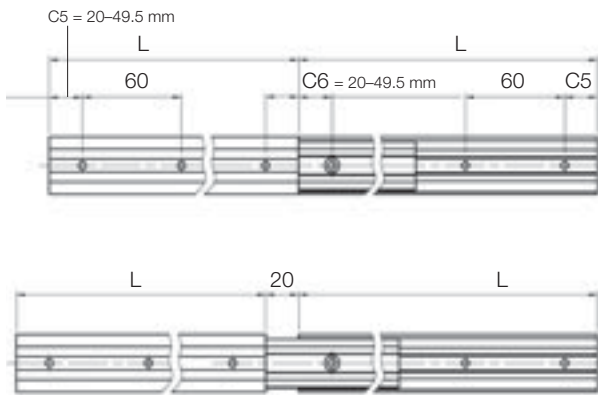

Dimensions (mm)

Detent in end and center position at full extension

Part No.	B (mm)	H (mm)	L min. (mm)	L max. (mm)
NT-LM-35-... mm	35	19	140	600



DryLin® NT-LM in adjustment of guard



DryLin® NT-LM in guard door adjustment in machine tool



The DryLin® WKM measuring systems are battery powered. The integrated battery guarantees two year operating time. This means a virtually absolute distance measurement is possible. Magnetic tapes fitted as standard. The position value is displayed on a 5-digit LC display.

- Measuring principle: magnetic with magnetic tape (10 · 1.4 mm)
- Resolution: 0.1 mm
- Accuracy: $\pm(0.1 + 0.01 \cdot \text{measured length (m)})$ mm
- Service life: over 5 years at 100% switch-on time
- Application temperature: +32 to +140 °C
- Display: LCD
- Repeat accuracy: ± 1 Digit
- Absolute and incremental measuring method capability
- Variable zero point
- Carriage can be clamped
- Display optionally right (R) or left (L) of guide carriage
- Max. rail length 4,000 mm
(Effective measurement max. 3,757 mm)

Type series WKM-10 and -20

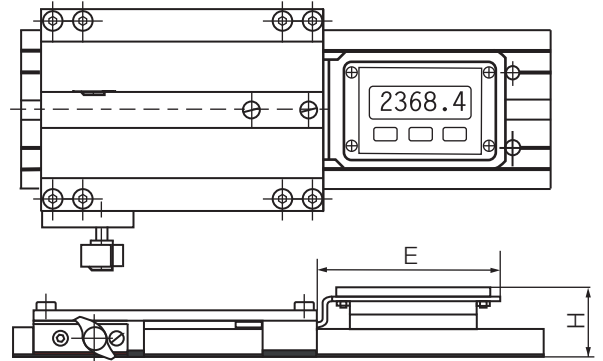

Dimensions (mm)

Part number	DryLin® linear guide	H	E
WKM-108015-01L	WK-10-80-15-01*	36	93
WKM-108015-01R	WK-10-80-15-01*	36	93
WKM-208015-01L	WK-20-80-15-01*	40	93
WKM-208015-01R	WK-20-80-15-01*	40	93

*For use on DryLin® W rail WS-10-80 ► Page 27.16

Type series WKM-11

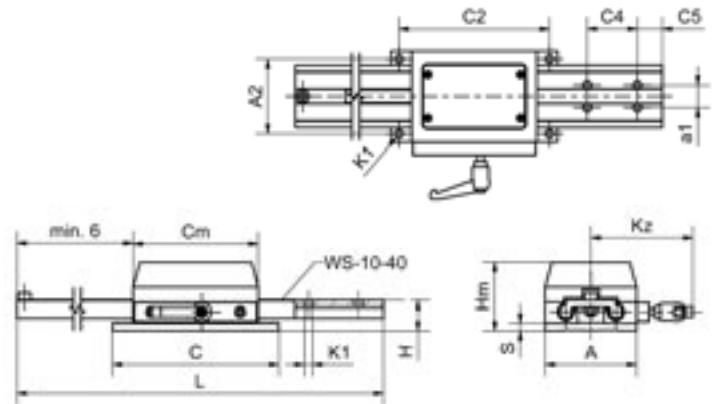

Dimensions (mm)

Part number	L	C4	C5	a1	C2	A2	K1	C	A	H	S	Cm	Hm	kz
WKM-11-40	2,000	40	20	18	120	80	8.6	133	73	24	8	100	54	82

*For use on DryLin® W rail WS-10-40 ► Page 27.16

Much less space is required for the latest DryLin® WKMEX measuring device. The sensor head is integrated in the carriage (total height 36 mm). There are three sensor types available, two are compatible with TTL Line Driver. We recommend igus® Energy Chain® series E2 micro or E-Z Chain for guiding the signal cable.

Type series WKM-10 and -20



- Ready-to-fit measuring device for external signal output
- With 4 edge trigger mode (setting parameters of the display or control, for example, IW4) and +68 °C ambient temperature:
Resolution: $\pm(0.025 + 0.02 \cdot L)$ L = measuring length in meters;
Repeatability: ± 0.025 mm
- With 1 edge trigger mode (setting parameters of the display or control, for example, IW1) and +68 °C ambient temperature:
Resolution: $\pm(0.1 + 0.02 \cdot L)$ L = measuring length in meters;
Repeatability: ± 0.025 mm
- Small sensor with integrated evaluation unit
- Fro use with DryLin® W rail WS-10-80 ▶ Page 27.16

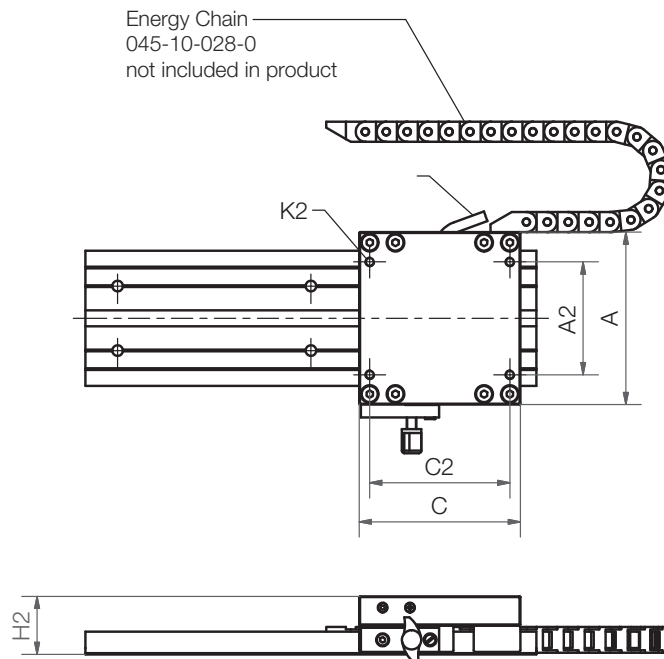

Dimensions (mm)

Part number	H2	C	C2	A	A2	K2	Resolution
WKMEX-10-80	36	100	87	107	70	M6	0.1

Versions

Sensor type	Nominal voltage	Output power	Max. length of signal cable
00	10–30 V	10–30 V	30 m
01	10–30 V	TTL Line Driver	50 m
11	5 V	TTL Line Driver	10 m



Torque resistant square guide

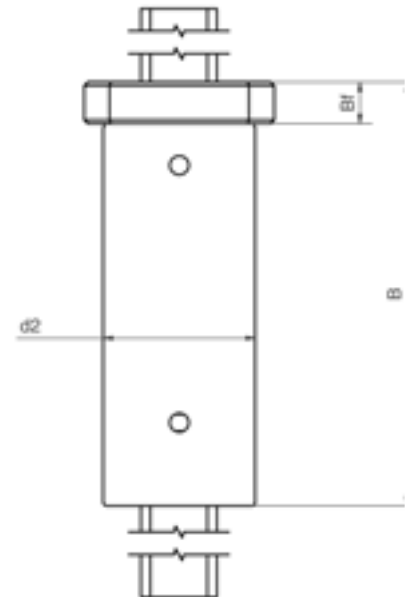
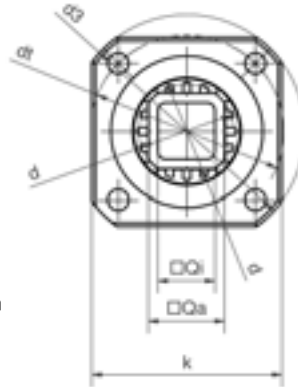

- Square section tube made of hard-anodized aluminum
- Anodized aluminum housing
- Torque resistant without need for second guide
- Tolerates moments up to 10 Nm
- Space saving and low weight
- Tube allows cable guidance
- Lubrication-free

DryLin® Q rail profile

Dimensions (mm)

Part number	Weight (kg)	A	H ±0.02
AWMQ-20	0.55	62	27

DryLin® Q Housing Bearing

Part number	Weight (kg)	A	H ±0.02	H1	dQ	Qa	Qi	E1 ±0.15	E2 ±0.15	d	L
QJRMT-05-20	0.55	62	27	54	25	20	15	48	55	28	85
QJRM-05-20	0.25	62	27	54	25	20	15	48	55	28	40

DryLin® Q Flange Bearing

Part number	Weight (kg)	k	d2 h7	Bf	d	Qa	Qi	d3 ±0.15	dt ±0.15	d	B
QJFMT-02-20	0.24	50	40	11	25	20	15	62	51	28	112
QJFM-02-20	0.14	50	40	11	25	20	15	62	51	28	58

Navigation icons: +, |, i, inch, mm

DryLin®



DryLin® Specialists

DryLin® Specialists

Telephone 1-800-521-2747
Fax 1-401-438-7270

Internet: <http://www.igus.com>
email: sales@igus.com
QuickSpec: <http://www.igus.com/iglide-quickspec>



igubal[®]

Design Guide



Rod ends

igubal® rod ends are available in a wide variety of different sizes and offered in 2 different series. The standard K series made with igumid G and iglide® L280, and our slightly thinner E series (the E Series and any CL version of a Rod End are offered with a variety of spherical ball materials).

Section 35



Clevis Joints

igubal® Clevis Joints are most often used by themselves or in conjunction with our E Series rod ends. There are a variety of different options available.

Section 36



Pillow Block

igubal® Pillow Blocks are especially designed to mount with 2-bolts making their installation easy, and the design and material combination allow for high rigidity and high radial load capacity.

Section 37



Flange Bearings

igubal® Flange Bearings were designed for shaft support. They are designed to have high rigidity and high radial load capacity. They come in a 2-bolt and 4-bolt option.

Section 38



Pressfit Bearings

There are a number of parts that fall under this category. From standard spherical ball in housings to double jointed bearings, pressfit bearings help allow for shaft misalignment.

Section 39



Temperature	Size Range	Maximum Angle of Pivot	Housing Material	Ball Material
-22°F to +176°F (-30°C to +80°C) High temp version -40°F to +392°F (-40°C to 200°C)	From 3/16 to 1" to 3 to 30 mm	14° to 40°	igumid G HT Material iguton G	Standard: iglide® L280 Other options: iglide® R iglide® J iglide® J4 Metal Sleeve Stainless Steel HT Housing: iglide® T500
-22°F to +176°F (-30°C to +80°C)	From 3/16 to 3/4" to 4 to 20 mm	N/A	igumid G	N/A
-22°F to +176°F (-30°C to +80°C)	From 3/16 to 1" to 5 to 50 mm	17° to 30°	igumid G	Standard: iglide® L280 Other options: iglide® R iglide® J iglide® J4
-22°F to +176°F (-30°C to +80°C) High temp version -40°F to +392°F (-40°C to 200°C)	From 3/16 to 1" to 3 to 30 mm	12° to 33°	igumid G HT Material iguton G	Standard: iglide® L280 Other options: iglide® R iglide® J iglide® J4 HT Housing: iglide® T500
-40°F to +482°F (-40°C to +250°C)	From 3/16 to 1" to 3 to 30 mm	5° to 37°	igumid G	Standard: iglide® L280 Other options: iglide® R iglide® J iglide® J4

igubal® self-aligning maintenance-free plain bearings made of high-performance plastics

igubal® offers a complete line of self-aligning bearings including; spherical bearings, pillow blocks, rod ends, clevis joints and flange bearings to name a few. The igubal® line is easy to install and allows the user to adjust for angular deviations.

With igubal®, it is possible to take advantage of the benefits of high-performance plastics including vibration dampening, ability to operate in water or chemicals, and their resistance to dirt and dust which makes them ideal in applications where a standard greased version will not be suitable.

Compared to its metal counterpart, igubal® is up to 80% lighter in weight and in some cases save on installation space due to smaller profiles. The maintenance-free aspect also helps to keep costs down.

Advantages of igubal®

- Cost-effective
- Maintenance-free
- Lubrication-free
- Resistant to dust and dirt
- Corrosion-free
- Can be used in liquid media
- Vibration dampening
- Inner race set in housings with very low clearance
- Dirt can become embedded for shaft protection
- 80% lighter than steel

igubal® Spherical Balls

In the igubal® K series the standard spherical ball is made out of our extremely wear resistant iglide® L280. Spherical balls made out of iglide® L280 material are known for their low coefficient of friction while running dry and extremely low tendency to stick-slip. This is especially important for low loads and very slow movements.

In the igubal® E series or the K series with the CL suffix, the spherical ball may be switched out to offer another alternative depending on application needs. The most popular alternative to iglide® L280 is our iglide® R for its cost advantage and also its low moisture absorption rate for applications where moisture is a concern. iglide® R still maintains a low coefficient of friction. Other specialized alternatives include iglide® J, iglide® J4, iglide® T500 (X) or iglide® UW (meant strictly for underwater applications). See our Materials Section in the front of the catalog for more information on each material

Advantages:

- Tough, resistant thermoplastic alloy
- Very low coefficients of friction while running dry
- High service life
- Vibration dampening
- Very good abrasion resistance
- Excellent wear resistance
- Maintenance-free
- Very good chemical resistance
- Suitable for rotating, oscillating and linear movements
- Also suitable for soft shafts

igubal® housing made of igumid G

The housings are made out of igumid G, a highly shock-resistant, long fiber-reinforced plastic. See page x.xx for material data

Advantages:

- Lightweight
- High mechanical strength
- Shock and impact resistant
- Corrosion-free
- Chemically resistant
- Dimensionally stable



Some models of the igubal® product line



igubal® flange bearings in reflector telescopes at La Palma, Spain, in the adjustment of the individual reflectors



igubal® rod end bearings in the cylinder-controlled steps of an RV



igubal® flange bearings as drive bearings in a conveyor system for bakery products

Loads

The load capacity of the maintenance-free igubal® bearing elements is very high at normal ambient temperatures. igubal® bearing elements absorb high forces and weigh only a fifth of traditional metal bearing housings. The excellent dampening properties are based on the fact that the plastic material of the two-part bearing can absorb vibrations differently than steel.

However, plastic-specific properties, such as temperature and behavior under long-time stressing, must be taken into consideration when using igubal® bearings. The load capacity should therefore be checked in a performance test, particularly if they are to be used under continuous high loads and at elevated temperatures. See each section for appropriate load data per part type.

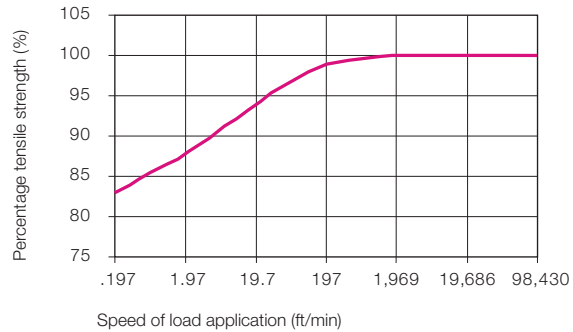

Effect of the speed of load application on the maximum tensile strength of igubal® rod end bearings

Coefficients of Sliding Friction and Speed

One important advantage of igubal® spherical bearings is that rapid, rotary movements of a mounted shaft take place directly in the spherical portion. In metallic rod ends, rotary motion takes place between the race and the spherical bearing. High speeds can be achieved with igubal® bearings.

igubal® bearings are used in such a way that the angular movements of the spherical bearings takes place at the outer diameter. In contrast, rotations of the shaft are supported directly in the I.D. of the spherical portion. The advantage, therefore, lies in the plastic vs. steel relationship. Plastic produces lower friction and permits high speeds, even when running dry.

Application Temperatures

igubal® bearing elements can be used in temperatures from -22 to 176°F. The chart shows the effect of temperature on the loading capacity of the igubal® bearing elements.

Application Temperatures

Minimum	-	22°F
Maximum, long-term	+	176°F
Maximum, short-term	+	248°F

Applications temperatures of igubal® bearing elements

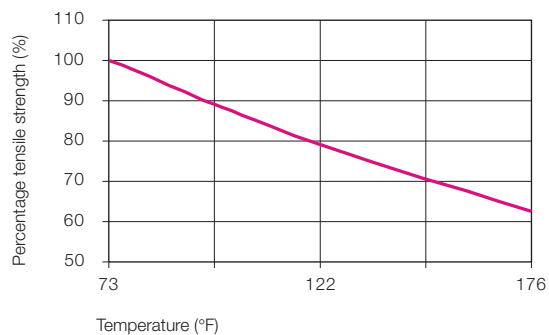

Effect of the temperature on the maximum tensile strength of igubal® rod end bearings

Chemical Resistance

Both the spherical ball made of iglide® L280 and the housing made of igumid G are resistant to weak lyes, weak acids and fuels, as well as all types of lubricants. You will find a chemicals table starting on Page 1.16. The moisture absorption of igubal® with iglide L280 is approximately 1.3% of weight in standard atmosphere. The saturation limit in water is 6.5%. The moisture absorption of igubal® with iglide® R is approximately .2% of weight in standard atmosphere. The saturation in water is 1.1%. This must be taken into account for these types of applications.

Medium	Resistance
Alcohol	+ to 0
Hydrocarbons, chlorinated	+
Greases, oils without additives	+
Fuels	+
Diluted acids	0 to -
Strong acids	-
Diluted alkalines	+
Strong alkalines	0

+ resistant, 0 conditionally resistant, - not resistant

Chemical resistance of iglide® L280

All data given concerns the chemical resistance at room temperature (68°F). For a complete list, see page 1.16



Radiation Resistance

Self-aligning igubal® plain bearings are resistant to radiation up to an intensity of 3×10^2 Gy.

UV Resistance

The corrosion resistance of the igubal® bearings give them special value for outside applications.

igubal® bearing elements are permanently resistant to UV radiation. A small change in color (dark coloration) of the spherical ball due to UV radiation does not effect the mechanical, electrical or thermal properties.

Areas of Application

igubal® bearing elements can be used without problems even in harsh environments. In moist or wet environments, the bearings are corrosion-resistant, and resistant to weak acids and lyes. The application temperatures range from -22 to 176°F. Resistance to dirt and dust is outstanding.

Seals are not necessary, even in extremely contaminated conditions. This is true for fine dust as well as coarse dirt, which is present in agricultural equipment. The housing is made of an impact-resistant composite material which tolerates high alternating loads.



igubal® rod end bearings in the spring loaded rear axle of a bicycle



igubal® flange bearings in the drive shaft of an outdoor cleaning machine



igubal® rod end bearing and spherical ball in a linear position sensor

Online tools.

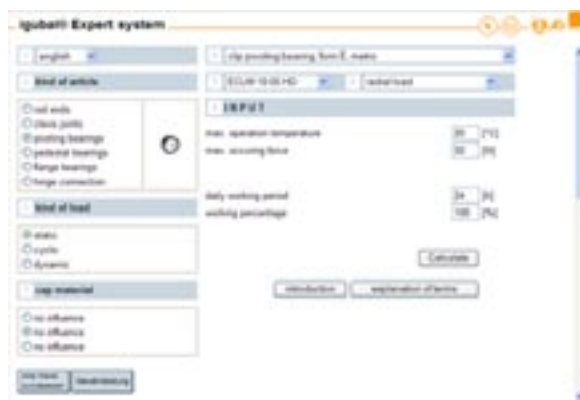

For online calculation visit:
www.igus.com and click on
the calculator

Material Table iglide® J, J4, L280 and R

General Properties	Unit	iglide® J	iglide® J4	iglide® L280	iglide® R
Color		yellow	gray	yellow	red
Max. moisture absorption at 73°F/50% r.h.	% weight	0.3	0.3	1.3	0.2
Max. moisture absorption	% weight	1.3	1.3	6.5	1.1
Mechanical Properties					
Modulus of elasticity	psi	348,000	340,750	507,500	290,000
Tensile strength at 68°F	psi	10,585	10,150	18,125	10,150
Permissible static surface pressure (68°F)	psi	5,075	5,075	8,700	3,335
Shore D-hardness		74	74	77	77
Physical and Thermal Properties					
Max. long-term application temperature	°F	194	194	194	194
Max. short-term application temperature	°F	248	248	356	230
Min. application temperature	°F	-58	-58	-40	-58

General Properties	Unit	igumid G	iglide® UW	iglide® T500
Color		black	black	black
Max. moisture absorption at 73°F/50% r.h.	% weight	1.4	0.2	0.3
Max. moisture absorption	% weight	5.6	0.8	1.1
Mechanical Properties				
Modulus of elasticity	psi	1,131,000	392,300	348,000
Tensile strength at 68°F	psi	34,800	13,000	13,775
Permissible static surface pressure (68°F)	psi	NA	5,800	21,750
Shore D-hardness		81	78	81
Physical and Thermal Properties				
Max. long-term application temperature	°F	248	194	482
Max. short-term application temperature	°F	356	230	590
Min. application temperature	°F	-40	-58	-148

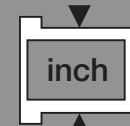

igubal®



igubal®
Spherical Bearings

Telephone 1-800-521-2747
Fax 1-401-438-7270

Internet: <http://www.igus.com>
email: sales@igus.com
QuickSpec: <http://www.igus.com/iglide-quickspec>

igus[®]



igubal[®] Rod Ends



**KBRI
KBLI**
Inner Thread
• inch

Page 35.6

K Series



**EBRI
EBLI**
Inner Thread
• inch

Page 35.7

E Series



**KBRM
KBLM**
Inner Thread
• metric
Also available:
Metal sleeve

Page 35.8

K Series



KBRM CL
Inner Thread
• metric

Page 35.10

K Series



**KCRM
KCLM**
Inner Thread
• metric

Page 35.11

K Series



**EBRM
EBLM**
Inner Thread
• metric

Page 35.12

E Series



**EBRM HT
EBLM HT**
Inner Thread
• metric

Page 35.13

E Series



KARI/KALI
Outer Thread
• inches

Page 35.14

K Series



**KARM
KALM**
Outer Thread
• metric
Also available:
Metal sleeve

Page 35.15

K Series



KARM CL
Outer Thread
• metric

Page 35.16

K Series



**EARM
EALM**
Outer Thread
• metric

Page 35.17

E Series



**EARM HT
EALM HT**
Outer Thread
• metric

Page 35.18

E Series



**PKRM
PKLM**
Accessory
Adapter Bolt

Page 35.19

K Series



**WGRM
WGLM**
Accessory
Ball & Socket Joint
Elbow

Page 35.20



**WGRM-LC
WGLM-LC**
Accessory

Page 35.21



**AGRM
AGLM**
Accessory
Ball & Socket Joint
Axial

Page 35.22



**AGRM-LC
AGLM-LC**
Accessory

Page 35.22

Typical industries and applications

- Industrial
- Machine building
- Industrial
- Packaging etc.



Bicycles



Textile industry



Packaging industry

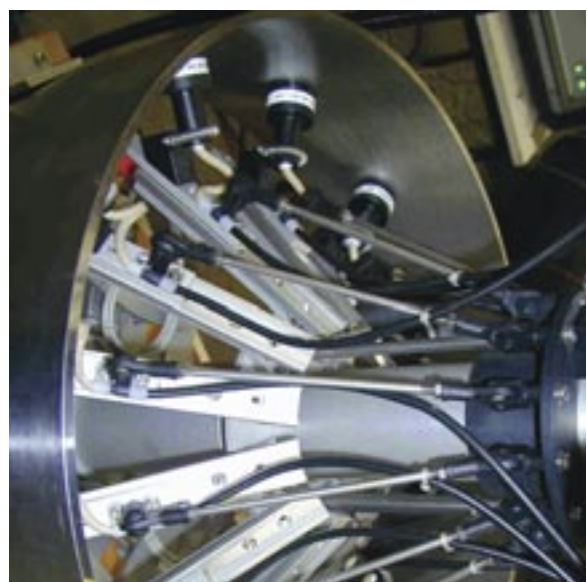

Offshore industry



Product Range

- Standard Styles:
Dimensional Series E
Dimensional Series K
- Type A - with outer threads
- Type B - with inner threads
- For shaft diameters:
Inch sizes from 3/16 - 1 in.
Metric sizes from 2 - 30 mm

Part Number Structure

Part Number Structure

K B R I - 10 - MH

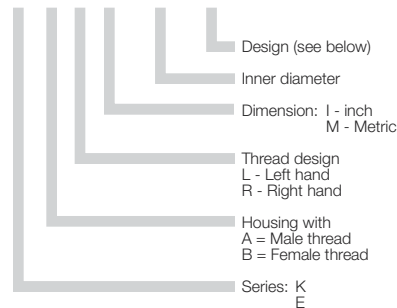

Design codes:

- CL = 2nd generation - only K series offering ability to change spherical ball material
- F = fine thread pitch
- HT = high temperature
- MH = with metal sleeve
- J = with spherical ball made from iglide® J
- J4 = with spherical ball made from iglide® J4
- R = with spherical ball made from iglide® R
- X = with spherical ball made from iglide® X
- EK = with stainless steel ball

The example given is the number for a rod end bearing of the dimensional series K with metric inner-right threading. The inner diameter of the spherical ball is 10 mm. It is a special design with a metal sleeve.

For the most part, the thread diameter of the bolt corresponds to the inner diameter — here it is M10. However, please pay attention to the following tables.

*The E series bearing is slightly thinner and costs less than its K series counterpart.

Usage Guidelines



- If a lightweight option is preferred
- In rotating, oscillating and linear movements
- If vibration dampening is desired
- If quiet operation is desired
- If corrosion resistance is required
- If chemical resistance is required
- If high rigidity is needed



- If temperatures are higher than +194°F
➤ HT version
- If rotation speeds are above 100 fpm
- If the ball is rotating and not the shaft in the ball
- If extreme tensile loads are present
- If dimensions above 1" or 30mm are necessary

The dimensional series K is available in inch dimensions, as well as a special version containing a stainless steel sleeve in the inner race. This allows a significantly higher torque than for the standard plastic race. Please ask us about quantities, availability and pricing.



Advantages

- Maintenance-free
- High strength under impact loads
- Very high tensile strength for varying loads
- Compensation for alignment errors
- Compensation for edge loads
- Resistant to dirt, dust and lint
- Resistant to corrosion and chemicals
- High vibration dampening capacity
- Suitable for rotating, oscillating and linear movements
- Lightweight
- Dimensional series K and E, dimensions according to standard DIN ISO 12240

Recommended Shaft Tolerances

Inch	Shaft		Metric	Shaft	
	Min.	Max.		Min.	Max.
3/16	0.1888	0.1900	2mm	1.975	2.000
1/4	0.2485	0.2500	3mm	2.975	3.000
5/16	0.3110	0.3125	5mm	4.970	5.000
3/8	0.3735	0.3750	6mm	5.970	6.000
7/16	0.4358	0.4375	8mm	7.964	8.000
1/2	0.4983	0.5000	10mm	9.964	10.000
5/8	0.6235	0.6250	12mm	11.957	12.000
3/4	0.7479	0.7500	16mm	15.957	16.000
1	0.9980	1.0000	20mm	19.948	20.000

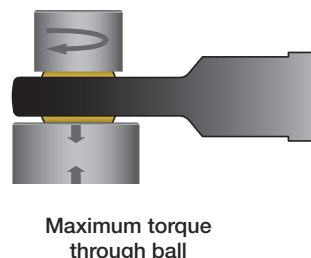
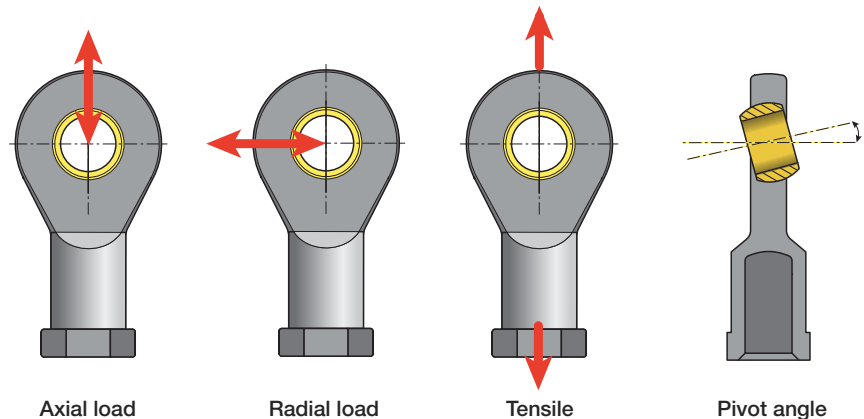



Loads

igubal® rod end bearings handle high loads at normal room temperatures, have excellent dampening properties and weigh only a fifth of traditional metallic rod end bearings. In applications with high continuous loads and high temperatures, the loading capacity of igubal® rod end bearings should be tested in an experiment that duplicates the application. See page 28.4 for load diagram.

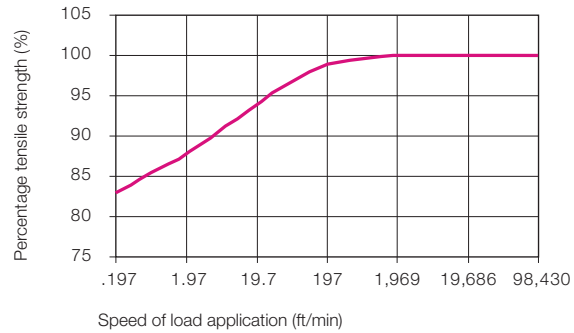

Effect of the speed of load application on the maximum tensile strength of igubal® rod end bearings

Coefficients of Friction and Speed

One important advantage of igubal® spherical bearings is that rapid, rotary movements of a mounted shaft take place directly in the spherical portion. In metallic rod ends, rotary motion takes place between the race and the spherical bearing. High speeds can be achieved with igubal® bearings. igubal® bearings are used in such a way that the angular movements of the spherical bearings take place at the spherical outer diameter. In contrast, rotations of the shaft are supported directly in the inner diameter of the spherical portion. The advantage, therefore, lies in the plastic vs. steel relationship. Plastic produces lower friction and permits high speeds, even when running dry. The maintenance-free igubal® bearing system is also suited for linear and oscillating shaft movements.

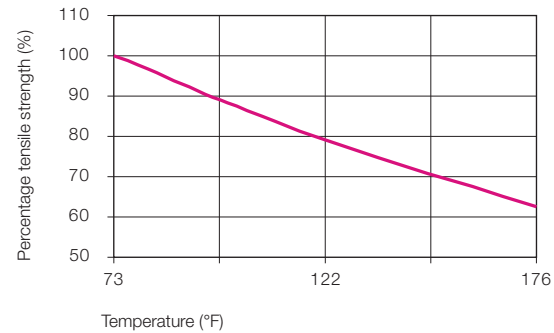

Effect of the temperature on the maximum tensile strength of igubal® rod end bearings

Tolerances

igubal® rod end bearings can be used at different tolerances depending on the individual application. As a standard program, they are designed with a large amount of bearing clearance, which permits secure operation even at high rotational speeds. The bore of the inner race is produced within a standard tolerance range. Shafts should also meet recommended tolerances. Please contact us with any questions regarding tolerances.

► Tolerance Table, Page 1.14



igubal® rod end bearings in the closing mechanism of an outdoor security gate

Thread Name	Pitch (mm)
M 2	0.40
M 3	0.50
M 4	0.70
M 5	0.80
M 6	1.00
M 8	1.25
M 10	1.50
M 10 F	1.25
M 12	1.75
M 12 F	1.25
M 14	2.00
M 16	2.00
M 16 F	1.50
M 18	1.50
M 20	2.50
M 20 M 20	1.50
M 22	1.50
M 24	2.00
M 27	2.00
M 30	2.00

Thread pitches of the igubal® rod end bearings

igubal® Rod Ends

PDF: www.igus.com/iglide-pdfs
CAD: www.igus.com/iglide-CAD
RoHS info: www.igus.com/RoHS

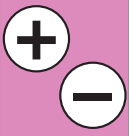



igubal® Spherical Bearings Rod Ends - inch - KBRI / KBLI

igubal® Rod Ends

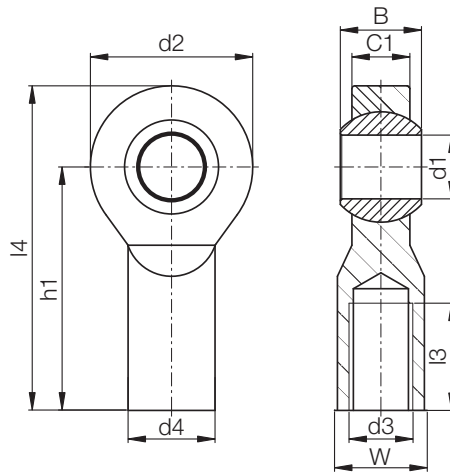

Material:
Housing - igumid G
Ball - iglide® L280
See Section 40 for ball material information

Dimensions (inch)

Part No. Right thread	Part No. Left thread	d1 (E10)	d2	d3	d4	C1	B	h1	L3	L4	W
KBRI-03	KBLI-03	.1900	.625	10-32	.406	.246	.312	1.062	.500	1.374	.312
KBRI-04	KBLI-04	.2500	.750	1/4-28	.469	.272	.365	1.312	.687	1.687	.375
KBRI-05	KBLI-05	.3125	.875	5/16-24	.500	.340	.437	1.375	.687	1.813	.437
KBRI-06	KBLI-06	.3750	1.000	3/8-24	.687	.394	.500	1.625	.812	2.125	.562
KBRI-07	KBLI-07	.4375	1.125	7/16-20	.750	.456	.562	1.812	.937	2.374	.625
KBRI-08	KBLI-08	.5000	1.312	1/2-20	.875	.487	.625	2.125	1.062	2.781	.750
KBRI-10	KBLI-10	.6250	1.500	5/8-18	1.000	.545	.750	2.500	1.375	3.250	.875
KBRI-12	KBLI-12	.7500	1.750	3/4-16	1.125	.676	.875	2.875	1.562	3.750	1.000
KBRI-16	KBLI-16	1.0000	2.750	1-12	1.625	1.000	1.375	4.125	2.125	5.500	1.500

Load Data

Part No. Right thread	Part No. Left thread	Maximum static Tensile Strength		Maximum Radial Load		Minimum Thread Depth (inch)	Maximum Torque Thread Strength ft lbs • force
		Short-term (lbs)	Long-term (lbs)	Short-term (lbs)	Long-term (lbs)		
KBRI-03	KBLI-03	203	102	67	34	.350	1.47
KBRI-04	KBLI-04	248	124	90	45	.480	3.68
KBRI-05	KBLI-05	383	192	112	56	.480	4.42
KBRI-06	KBLI-06	450	225	225	112	.568	5.16
KBRI-07	KBLI-07	518	259	270	135	.655	13.27
KBRI-08	KBLI-08	585	293	337	169	.743	16.96
KBRI-10	KBLI-10	1103	551	382	191	.962	22.12
KBRI-12	KBLI-12	1260	630	517	259	1.093	29.50
KBRI-16	KBLI-16	1349	674	584	293	1.488	33.92

Right thread	Left thread	Maximum Angle of Pivot	Weight (g)
KBRI-03	KBLI-03	25°	3.3
KBRI-04	KBLI-04	25°	5.1
KBRI-05	KBLI-05	25°	7.1
KBRI-06	KBLI-06	22°	12.6
KBRI-07	KBLI-07	22°	16.1
KBRI-08	KBLI-08	22°	26.5
KBRI-10	KBLI-10	22°	38.7
KBRI-12	KBLI-12	22°	54.4
KBRI-16	KBLI-16	20°	197.5

Telephone 1-800-521-2747
Fax 1-401-438-7270

Internet: <http://www.igus.com>
email: sales@igus.com
QuickSpec: <http://www.igus.com/iglide-quickspec>

igubal® Spherical Bearings Rod Ends - inch - EBRI / EBLI

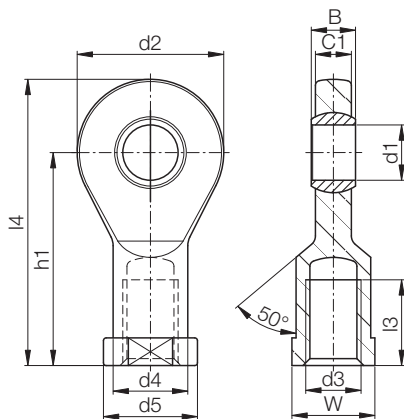

Material:

Housing - igumid G

Ball - iglide® L280

Also available:

iglide® R, iglide® J and iglide® J4

See Section 40 for ball material information

igubal® Rod Ends

Dimensions (inch)

Part No. Right thread	Part No. Left thread	d1 (E10)	d2	d3	d4	d5	C1	B	h1	l3	l4	W	Max. Angle of Pivot
EBRI-03	EBLI-03	0.1900	0.748	10-32	0.3543	0.4331	0.1732	0.1900	1.1811	0.4724	1.5551	0.35	30°
EBRI-04	EBLI-04	0.2500	0.827	1/4-28	0.4331	0.5118	0.1732	0.2500	1.1811	0.4724	1.5945	0.43	25°
EBRI-05	EBLI-05	0.3125	0.945	5/16-24	0.5118	0.6299	0.2362	0.3125	1.4173	0.6299	1.8898	0.55	22°
EBRI-06	EBLI-06	0.3750	1.142	3/8-24	0.5906	0.7480	0.2756	0.3750	1.6929	0.7087	2.2638	0.67	22°
EBRI-07	EBLI-07	0.4375	1.339	7/16-20	0.7087	0.8661	0.3150	0.4063	1.9685	0.7874	2.6378	0.75	18°
EBRI-08	EBLI-08	0.5000	1.339	1/2-20	0.7087	0.8661	0.3150	0.4063	1.9685	0.7874	2.6378	0.75	18°
EBRI-10	EBLI-10	0.6250	1.693	5/8-18	0.8270	1.0230	0.4134	0.5000	2.5394	1.0433	3.3858	0.87	16°
EBRI-12	EBLI-12	0.7500	2.087	3/4-16	1.0630	1.3386	0.5118	0.6250	3.0315	1.2205	4.0748	1.18	14°

Load Data

Part No. Right thread	Part No. Left thread	Max. static Tensile Strength		Max. Cross Force		Min. Thread Depth (inch)	Max. Torque Strength Outer thread (ft•lbs)	Max. Torque Strength Through Ball (ft•lbs)	Weight (g)
		Short-term (lbs)	Long-term (lbs)	Short-term (lbs)	Long-term (lbs)				
EBRI-03	EBLI-03	292	146	34	17	.315	1.48	1.5	3.1
EBRI-04	EBLI-04	337	168	45	22	.315	3.68	1.8	3.8
EBRI-05	EBLI-05	449	224	101	51	.433	4.42	5.2	6.9
EBRI-06	EBLI-06	517	258	112	56	.512	5.17	10.3	11.5
EBRI-07	EBLI-07	741	370	124	62	.551	13.28	18.4	17.6
EBRI-08	EBLI-08	741	370	124	62	.551	16.96	18.4	18.1
EBRI-10	EBLI-10	1124	539	191	96	.709	22.00	22.1	31.9
EBRI-12	EBLI-12	1618	809	405	202	.866	30.00	29.5	61.5

For another spherical bearing material please add J, R or J4 to the part number; e.g. EBRI-08R

► Tolerance Table, Page 1.14

PDF: www.igus.com/iglide-pdfs
CAD: www.igus.com/iglide-CAD
RoHS info: www.igus.com/RoHS

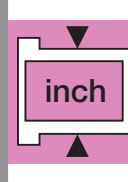
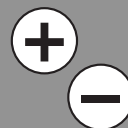



igubal® Spherical Bearings Rod Ends - mm - KBRM / KBLM

igubal® Rod Ends

Telephone 1-800-521-2747
Fax 1-401-438-7270

Internet: <http://www.igus.com>
email: sales@igus.com
QuickSpec: <http://www.igus.com/iglide-quickspec>



Standard Design



Design with Metal Sleeve (MH)

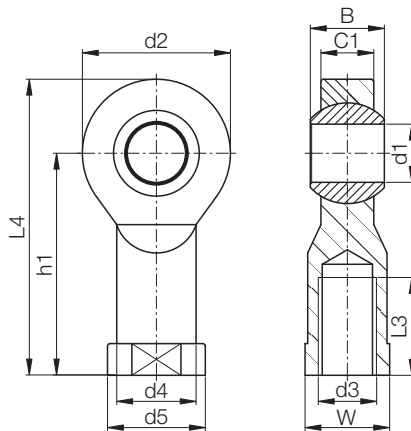

Material:

Housing - igumid G
Ball - iglide® L280, with metal sleeve

See Section 40 for ball material information

Dimensions (mm)

		d1	d2	d3	d4	d5	C1	B	h1	L3	L4	W
Right thread	Left thread	E10										
KBRM-02	KBLM-02	2	9	M02	4.0	4.6	3.0	4	12.5	6	17	SW04
KBRM-03	KBLM-03	3	13	M03	6.5	8.0	4.5	6	18.5	8	25	SW07
KBRM-05 M4	KBLM-05 M4	5	18	M04	9.0	12.0	6.0	8	27	10	36	SW09
KBRM-05	KBLM-05	5	18	M05	9.0	12.0	6.0	8	27	10	36	SW09
KBRM-06	KBLM-06	6	20	M06	10.0	13.0	7.0	9	30	12	40	SW11
KBRM-08	KBLM-08	8	24	M08	13.0	16.0	9.0	12	36	16	48	SW14
KBRM-10	KBLM-10	10	30	M10	15.0	19.0	10.5	14	43	20	58	SW17
KBRM-10 F	KBLM-10 F	10	30	M10 x 1.25	15.0	19.0	10.5	14	43	20	58	SW17
KBRM-12	KBLM-12	12	34	M12	18.0	22.0	12.0	16	50	22	67	SW19
KBRM-12 F	KBLM-12 F	12	34	M12 x 1.25	18.0	22.0	12.0	16	50	22	67	SW19
KBRM-14	KBLM-14	14	38	M14	20.0	25.0	13.5	19	57	25	76	SW22
KBRM-16	KBLM-16	16	42	M16	22.0	27.0	15.0	21	64	28	85	SW22
KBRM-16 F	KBLM-16 F	16	42	M16 x 1.5	22.0	27.0	15.0	21	64	28	85	SW22
KBRM-18	KBLM-18	18	46	M18 x 1.5	25.0	31.0	16.5	23	71	32	94	SW27
KBRM-20	KBLM-20	20	50	M20 x 2.5	28.0	34.0	18.0	25	77	33	102	SW30
KBRM-20 M20	KBLM-20 M20	20	50	M20 x 1.5	28.0	34.0	18.0	25	77	33	102	SW30
KBRM-22	KBLM-22	22	56	M22 x 1.5	30.0	37.0	20.0	28	84	37	112	SW32
KBRM-25	KBLM-25	25	60	M24 x 2.0	32.0	41.0	22.0	31	94	42	124	SW36
KBRM-30	KBLM-30	30	70	M30 x 2.0	37.0	50.0	25.0	37	110	51	145	SW41

Rod end bearings can be ordered in metric dimensions with metal sleeve with the addition of MH after the part numbers listed here
Example: KBRM-10 MH

► Tolerance Table, Page 1.14



Load Data

Part No. Right thread	Part No. Left thread	Max. static Tensile Strength		Max. Radial Load		Min. Thread Depth (mm)	Max. Torque Strength Inner thread (ft•lbs)	Max. Torque Strength	
		Short term (lbs)	Long term (lbs)	Short term (lbs)	Long term (lbs)			Standard (ft•lbs)	MH (ft•lbs)
KBRM-02	KBLM-02	134	67	13	6	4	.22	.74	1.5
KBRM-03	KBLM-03	179	89	22	11	5	.37	1.5	3.0
KBRM-05 M4	KBLM-05 M4	224	112	56	28	7	.55	3.7	8.9
KBRM-05	KBLM-05	224	112	56	28	7	.74	3.7	8.9
KBRM-06	KBLM-06	314	157	89	44	8	1.10	7.4	11.1
KBRM-08	KBLM-08	472	236	157	78	11	7.4	8.9	29.5
KBRM-10	KBLM-10	696	348	179	89	13	11.1	14.8	36.9
KBRM-10 F	KBLM-10 F	696	348	179	89	13	4.4	14.8	36.9
KBRM-12	KBLM-12	809	404	202	101	15	14.8	22.1	51.6
KBRM-12 F	KBLM-12 F	809	404	202	101	15	11.1	22.1	51.6
KBRM-14	KBLM-14	899	449	224	112	17	18.4	25.8	55.3
KBRM-16	KBLM-16	944	472	292	146	19	22.1	29.5	81.1
KBRM-16 F	KBLM-16 F	944	472	292	146	19	20.3	29.5	81.1
KBRM-18	KBLM-18	1034	517	359	179	21	33.2	33.2	110.6
KBRM-20	KBLM-20	1213	606	472	236	22	59.0	40.6	147.5
KBRM-20 M20	KBLM-20 M20	1213	606	472	236	22	44.3	40.6	147.5
KBRM-22	KBLM-22	1573	786	494	247	25	55.3	44.3	166.0
KBRM-25	KBLM-25	1910	955	517	258	28	88.5	44.3	191.8
KBRM-30	KBLM-30	2360	1180	562	281	34	99.5	44.3	221.3

Part No. Right thread	Part No. Left thread	Maximum Angle of Pivot	Weight (g)
KBRM-02	KBLM-02	30°	0.4
KBRM-03	KBLM-03	30°	2.7
KBRM-05 M4	KBLM-05 M4	30°	3.5
KBRM-05	KBLM-05	30°	3.4
KBRM-06	KBLM-06	29°	4.7
KBRM-08	KBLM-08	25°	8.6
KBRM-10	KBLM-10	25°	14.6
KBRM-10 F	KBLM-10 F	25°	14.6
KBRM-12	KBLM-12	25°	22.0
KBRM-12 F	KBLM-12 F	25°	22.0
KBRM-14	KBLM-14	23°	30.9
KBRM-16	KBLM-16	23°	39.6
KBRM-16 F	KBLM-16 F	23°	39.6
KBRM-18	KBLM-18	23°	55.0
KBRM-20	KBLM-20	23°	73.5
KBRM-20 M20	KBLM-20 M20	23°	73.5
KBRM-22	KBLM-22	22°	94.8
KBRM-25	KBLM-25	22°	119.8
KBRM-30	KBLM-30	22°	177.0

igubal® Rod Ends

PDF: www.igus.com/iglide-pdfs
CAD: www.igus.com/iglide-CAD
RoHS info: www.igus.com/RoHS

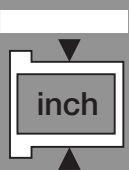
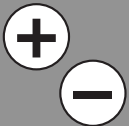



igubal® Spherical Bearings Rod Ends - mm - KBRM CL

igubal® Rod Ends

Telephone 1-800-521-2747
Fax 1-401-438-7270

Internet: <http://www.igus.com>
email: sales@igus.com
QuickSpec: <http://www.igus.com/iglide-quickspec>

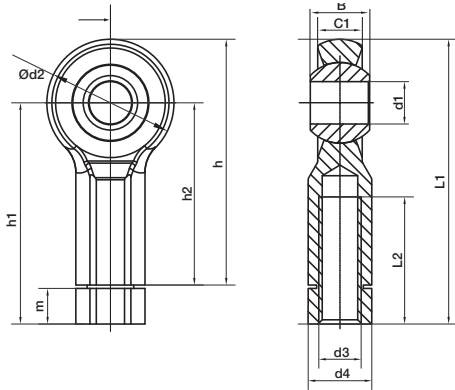

Material:

Housing - igumid G

Ball - iglide® L280

Also available:

iglide® J, iglide® J4, iglide® R,
with metal sleeve

**See Section 40 for ball
material information**



Simple assembly due to the
hexagonal body and the
integrated lock nut.

Dimensions (mm)

Part No.	d1 (E10)	d2	d3	d4	B	C1	h	h1	h2	L2	L1	Max. pivot angle
KBRM-06 CL	6	20	M06	SW10	9	7	40	5,7	30	20	46.5	40°
KBRM-08 CL	8	24	M08	SW13	12	9	48	7,5	36	25	56.3	35°
KBRM-10 CL	10	30	M10	SW15	14	10.5	58	52.2	43	30	67.2	35°

► Tolerance Table, Page 1.14

Load Data

Part No.	Maximum static tensile strength		Maximum radial load		Minimum thread depth (mm)	Max. torque strength outer thread (ft•lbs)	Max. torque through Ball		Weight (g)
	Short term (lbs)	Long term (lbs)	Short term (lbs)	Long term (lbs)			standard (ft•lbs)	MH (ft•lbs)	
KBRM-06 CL	315	158	90	45	8	1.106	7.376	11.060	4.5
KBRM-08 CL	473	236	158	79	11	7.376	8.851	29.500	8.6
KBRM-10 CL	698	349	180	90	13	11.060	14.750	36.880	14.1

For rod end bearings with metal sleeve please add **MH** to the part number, e.g. KBRM-10 CL **MH**.

For another spherical bearing material please add **J, J4, or R** to the part number, e.g. KBRM-10 CL **J**.

igubal® Spherical Bearings Rod Ends - mm - KCRM/KCLM



Special properties

- Available with metal sleeve for higher torque strength

Material:

Housing - igumid G

Ball - iglide® L280

Also available:

iglide® J, iglide® J4, iglide® R,
with metal sleeve

**See Section 40 for ball
material information**

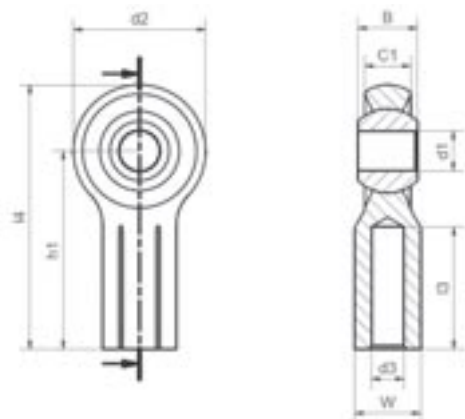

Dimensions (mm)

Part No. Right thread	Part No. Left thread	d1 (E10)	d2	d3	W	B	C1	h1	L3	L4	Max. pivot angle
KCRM-06	KCLM-06	6	20	M06	SW10	9	7	30	13.5	40	40°
KCRM-08	KCLM-08	8	24	M08	SW13	12	9	36	17	48	35°
KCRM-10	KCLM-10	10	30	M10	SW15	14	10,5	43	22	58	35°

► Tolerance Table, Page 1.14

Load Data

Part No. Right thread	Part No. Left thread	Maximum static tensile strength		Maximum Static radial load		Max. torque strength Inner thread (ft•lbs)	Max. torque through Ball		Weight (g)
		Short term (lbs)	Long term (lbs)	Short term (lbs)	Long term (lbs)		Standard (ft•lbs)	MH (ft•lbs)	
KCRM-06	KCLM-06	315	156	67	34	.55	7.376	11.060	4.2
KCRM-08	KCLM-08	472	236	112	56	1.48	8.851	29.500	7.6
KBRM-10	KCLM-10	697	337	180	90	2.2	14.750	36.880	12.8

For rod end bearings with metal sleeve please add **MH** to the part number, e.g. KCRM-10 **MH**.

For another spherical bearing material please add **J, J4, or R** to the part number, e.g. KBRM-10 **CL J**.

PDF: www.igus.com/iglide-pdfs
CAD: www.igus.com/iglide-CAD
RoHS info: www.igus.com/RoHS

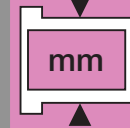
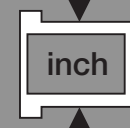
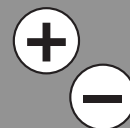



igubal® Spherical Bearings Rod Ends - mm - EBRM / EBLM

igubal® Rod Ends

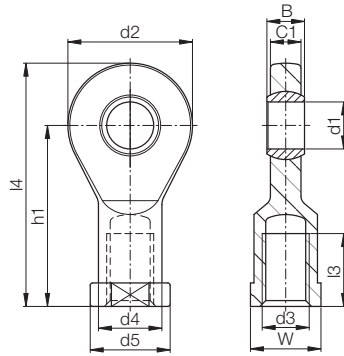

Material:

Housing - igumid G

Ball - iglide® L280

Also available :

iglide® R, iglide® J and iglide® J4

See Section 40 for ball material information

Telephone 1-800-521-2747
Fax 1-401-438-7270

Dimensions (mm)

Part No. Right thread	Part No. Left thread	d1 (E10)	d2	d3	d4	d5	C1	B	h1	l3	l4	W	Max. Angle of Pivot
EBRM-04	EBLM-04	4	15	M04	8.0	9.2	3.5	5	22.5	9.5	30.0	SW08	33°
EBRM-05	EBLM-05	5	19	M05	9.0	11	4.4	6	30	12	39.5	SW09	33°
EBRM-06	EBLM-06	6	21	M06	11.0	13	4.4	6	30	12	40.5	SW11	27°
EBRM-08	EBLM-08	8	24	M08	13.0	16	6.0	8	36	16	48.0	SW14	24°
EBRM-10	EBLM-10	10	29	M10	15.0	19	7.0	9	43	18	57.5	SW17	24°
EBRM-10 F	EBLM-10 F	10	29	M10x1.25	15.0	19	7.0	9	43	18	57.5	SW17	24°
EBRM-12	EBLM-12	12	34	M12	18.0	22	8.0	10	50	20	67.0	SW19	21°
EBRM-12 F	EBLM-12 F	12	34	M12x1.25	18.0	22	8.0	10	50	20	67.0	SW19	21°
EBRM-15	EBLM-15	15	40	M14	21.0	26	10.0	12	61	26	81.0	SW22	21°
EBRM-17	EBLM-17	17	46	M16	24.0	30	11.0	14	67	27	90.0	SW27	21°
EBRM-17 F	EBLM-17 F	17	46	M16x1.5	24.0	30	11.0	14	67	27	90.0	SW27	18°
EBRM-20	EBLM-20	20	53	M20x1.5	27.0	34	13.0	16	77	31	103.5	SW30	16°
EBRM-20 M20	EBLM-20 M20	20	53	M20x2.5	27.0	34	13.0	16	77	31	103.5	SW30	16°
EBRM-25	EBLM-25	25	64	M24x2.0	34.0	41	17.0	20	94	38	126.5	SW36	16°
EBRM-30	EBLM-30	30	73	M30x2.0	41.0	48	19.0	22	110	47	146.5	SW41	13°

► Tolerance Table, Page 1.14

Load Data

Part No. Right thread	Part No. Left thread	Max. static Tensile Strength		Max. Radial Load		Min. Thread Depth (mm)	Max. Torque Strength Inner thread (ft•lbs)	Max. Torque Strength Through Ball (ft•lbs)	Weight (g)
		Short term (lbs)	Long term (lbs)	Short term (lbs)	Long term (lbs)				
EBRM-04	EBLM-04	180	90	22	11	7	.3	1.5	1.8
EBRM-05	EBLM-05	292	146	34	17	8	.4	1.5	3.2
EBRM-06	EBLM-06	337	168	45	22	8	1.1	1.8	4.0
EBRM-08	EBLM-08	449	224	101	51	11	3.7	5.2	6.9
EBRM-10	EBLM-10	517	258	112	56	13	11.1	10.3	11.2
EBRM-10 F	EBLM-10 F	517	258	112	56	13	4.4	10.3	11.2
EBRM-12	EBLM-12	741	370	124	62	14	14.8	18.4	17.1
EBRM-12 F	EBLM-12 F	741	370	124	62	14	11.1	18.4	17.1
EBRM-15	EBLM-15	1079	539	180	90	18	18.4	22.1	28.9
EBRM-17	EBLM-17	1191	595	247	124	19	22.1	25.8	42.4
EBRM-17 F	EBLM-17 F	1191	595	247	124	19	20.3	25.8	42.4
EBRM-20	EBLM-20	1618	809	405	202	22	44.3	29.5	65.8
EBRM-20 M20	EBLM-20 M20	1618	809	405	202	22	59.0	29.5	65.8
EBRM-25	EBLM-25	2248	1124	584	292	27	84.8	40.6	125.9
EBRM-30	EBLM-30	2360	1180	674	337	33	95.9	51.6	184.1

For another spherical bearing material please add **J**, **J4**, or **R** to the part number, e.g. EBRM-10 CL J.

Internet: <http://www.igus.com>
email: sales@igus.com
QuickSpec: <http://www.igus.com/iglide-quickspec>

igubal® Spherical Bearings Rod Ends - mm - EBRM HT / EBLM HT

The EBRMHT / EBLM HT version is for those applications with higher temperature requirements



Special properties

- For temperatures up to 392 °F
- Dimensional series K according to standard DIN ISO 12240

Material:

Housing - iguton G

Ball - iglide® T500

See Section 40 for ball material information

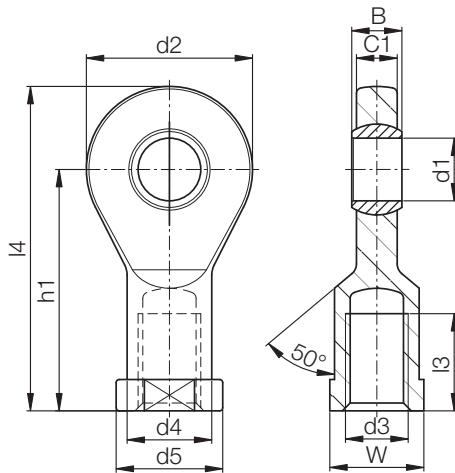

Dimensions (mm)

Part No.	Part No.	d1 (E10)	d2	d3	d4	d5	C1	B	h1	l3	l4	W	Max. angle of pivot	Weight (g)
EBRM-05 HT	EBLM-05 HT	5	19	M05	9.0	11	4.4	6	30	12	39.5	SW09	33°	3.8
EBRM-06 HT	EBLM-06 HT	6	21	M06	11.0	13	4.4	6	30	12	40.5	SW11	27°	5.0
EBRM-08 HT	EBLM-08 HT	8	24	M08	13.0	16	6.0	8	36	16	48.0	SW14	24°	8.5
EBRM-10 HT	EBLM-10 HT	10	29	M10	15.0	19	7.0	9	43	18	57.5	SW17	24°	13.7
EBRM-12 HT	EBLM-12 HT	12	34	M12	18.0	22	8.0	10	50	20	67.0	SW19	21°	21.4

► Tolerance Table, Page 1.14

PDF: www.igus.com/iglide-pdfs
CAD: www.igus.com/iglide-CAD
RoHS info: www.igus.com/RoHS



igubal® Rod Ends



igubal® Spherical Bearings Rod Ends - inch - KARI / KALI

igubal® Rod Ends

Telephone 1-800-521-2747
Fax 1-401-438-7270

Internet: <http://www.igus.com>
email: sales@igus.com
QuickSpec: <http://www.igus.com/iglide-quickspec>

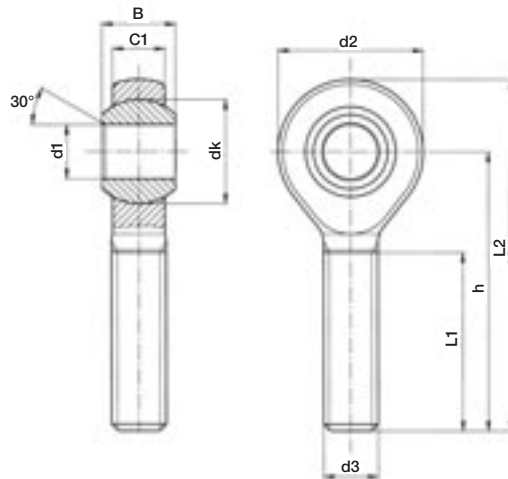

Material:
Housing - igumid G
Ball - iglide® L280
See Section 40 for ball material information

Dimensions (inch)

Part No. Right thread	Part No. Left thread	d1 (E10)	d2	d3	C1	B	h	L1	L2	Max. Pivot angle	Weight (g)
KARI-03	KALI-03	.1900	.625	10-32	.234	.312	1.250	.750	1.563	25°	2.1
KARI-04	KALI-04	.2500	.750	1/4-28	.250	.365	1.562	1.000	1.937	25°	3.5
KARI-05	KALI-05	.3125	.875	5/16-24	.312	.437	1.875	1.250	2.313	25°	6.0
KARI-06	KALI-06	.3750	1.000	3/8-24	.359	.500	1.938	1.250	2.438	22°	8.8
KARI-07	KALI-07	.4375	1.125	7/16-20	.406	.562	2.125	1.375	2.688	22°	12.4
KARI-08	KALI-08	.5000	1.312	1/2-20	.453	.625	2.428	1.500	3.094	22°	18.5
KARI-10	KALI-10	.6250	1.500	5/8-18	.484	.750	2.625	1.625	3.375	22°	27.6
KARI-12	KALI-12	.7500	1.750	3/4-16	.593	.875	2.875	1.750	3.750	22°	42.8

► Tolerance Table, Page 1.14

Load Data

Part No. Right thread	Part No. Left thread	Maximum static Tensile Strength		Maximum Radial Load		Minimum Thread Depth (inch)	Maximum torque Strength Outer thread (ft•lbs)	Maximum Torque through ball (ft•lbs)
		Short-term (lbs)	Long-term (lbs)	Short-term (lbs)	Long-term (lbs)			
KARI-03	KALI-03	87	45	15	7	.525	.36	.37
KARI-04	KALI-04	202	101	22	11	.700	.73	.74
KARI-05	KALI-05	247	123	33	16	.875	1.47	1.48
KARI-06	KALI-06	337	168	78	39	.875	2.21	2.21
KARI-07	KALI-07	449	224	89	45	.962	4.42	4.43
KARI-08	KALI-08	562	281	101	50	1.050	6.63	6.64
KARI-10	KALI-10	786	393	134	67	1.137	8.85	8.85
KARI-12	KALI-12	876	438	224	112	1.226	18.43	18.44

igubal® Spherical Bearings Rod Ends - mm - KARM / KALM



Standard Design



Design with Metal Sleeve (MH)

Rod end bearings can be ordered in metric dimensions with metal sleeve with the addition of MH after the part numbers listed here, i.e. for example: KARM-10 MH Available for delivery

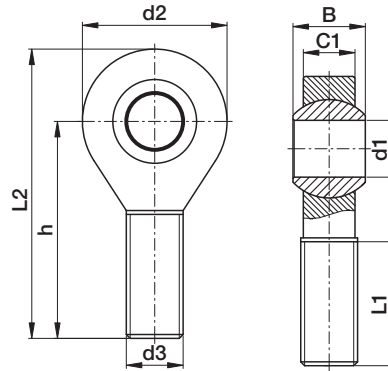

Dimensions (mm)

Part No.	Part No.	d1	d2	d3	C1	B	h	L1	L2	Max. Pivot angle	Min. Thread Depth
Right thread	Left thread	(E10)									(mm)
KARM-05	KALM-05	5	18	M05	6.0	8.0	33	19	42	30°	13
KARM-06	KALM-06	6	20	M06	7.0	9.0	36	21	46	29°	15
KARM-08	KALM-08	8	24	M08	9.0	12.0	42	25	55	25°	18
KARM-10	KALM-10	10	30	M10	10.5	14.0	48	28	63	25°	20
KARM-10 F	KALM-10 F	10	30	M10 x 1.25	10.5	14.0	48	28	63	25°	20
KARM-12	KALM-12	12	34	M12	12.0	16.0	54	32	71	25°	22
KARM-12 F	KALM-12 F	12	34	M12 x 1.25	12.0	16.0	54	32	71	25°	22
KARM-14	KALM-14	14	38	M14	13.5	19.0	61	36	79	25°	25
KARM-16	KALM-16	16	42	M16	15.0	21.0	66	37	88	23°	26
KARM-16 F	KALM-16 F	16	42	M16 x 1.5	15.0	21.0	66	37	88	23°	26
KARM-18	KALM-18	18	46	M18 x 1.5	16.5	23.0	72	41	96	23°	29
KARM-20	KALM-20	20	50	M20 x 2.5	18.0	25.0	78	45	104	23°	32
KARM-20 M20	KALM-20 M20	20	50	M20 x 1.5	18.0	25.0	78	45	104	23°	32
KARM-22	KALM-22	22	56	M22 x 1.5	20.0	28.0	84	48	112	22°	34
KARM-25	KALM-25	25	60	M24 x 2.0	22.0	31.0	94	55	125	22°	39
KARM-30	KALM-30	30	70	M30 x 2.0	25.0	37.0	110	66	147	22°	46

► Tolerance Table, Page 1.14

Load Data

Part No.	Part No.	Max. Static Tensile Strength		Max. Radial Load		Max. Torque Strength Inner threading (ft•lbs)	Max. Torque Strength		Shaft	
		Short-term (lbs)	Long-term (lbs)	Short-term (lbs)	Long-term (lbs)		Standard (ft•lbs)	MH (ft•lbs)	Min.	Max.
KARM-05	KALM-05	180	90	18	9	.3	3.7	8.8	4.970	5.000
KARM-06	KALM-06	225	112	22	11	.4	7.4	11.1	5.970	6.000
KARM-08	KALM-08	382	191	45	22	1.5	8.9	29.5	7.964	8.000
KARM-10	KALM-10	562	281	67	33	3.7	14.8	36.9	9.964	10.000
KARM-10 F	KALM-10 F	562	281	67	33	2.2	14.8	36.9	9.964	10.000
KARM-12	KALM-12	607	303	89	45	4.4	22.1	51.6	11.957	12.000
KARM-12 F	KALM-12 F	607	303	89	45	4.4	22.1	51.6	11.957	12.000
KARM-14	KALM-14	764	382	157	78	8.9	25.8	55.3	13.957	14.000
KARM-16	KALM-16	876	438	179	89	12.5	29.5	81.1	15.957	16.000
KARM-16 F	KALM-16 F	876	438	179	89	12.5	29.5	81.1	15.957	16.000
KARM-18	KALM-18	944	472	224	112	14.8	33.2	110.6	17.957	18.000
KARM-20	KALM-20	1348	674	292	146	18.4	40.6	147.5	19.948	20.000
KARM-20 M20	KALM-20 M20	1348	674	292	146	18.4	40.6	147.5	19.948	20.000
KARM-22	KALM-22	1618	809	337	168	18.4	44.3	166.0	21.948	22.000
KARM-25	KALM-25	1686	843	427	213	33.2	47.9	191.8	24.948	25.000
KARM-30	KALM-30	1978	989	517	258	62.7	51.6	221.3	29.948	30.000

For rod end bearings with metal sleeve please add **MH** to the part number, e.g. KARM-10 **MH**.

igubal® Rod Ends

PDF: www.igus.com/iglide-pdfs
CAD: www.igus.com/iglide-CAD
RoHS info: www.igus.com/RoHS

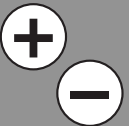



igubal® Spherical Bearings Rod Ends - mm - KARM CL

igubal® Rod Ends



Special properties

- Available with metal sleeve for higher torque strength
- Left-hand thread version KALM in preparation

Material:

Housing - igumid G

Ball - iglide® L280

Also available :

iglide® R, iglide® J and iglide® J4

or with metal sleeve

See Section 40 for ball material information

Telephone 1-800-521-2747
Fax 1-401-438-7270

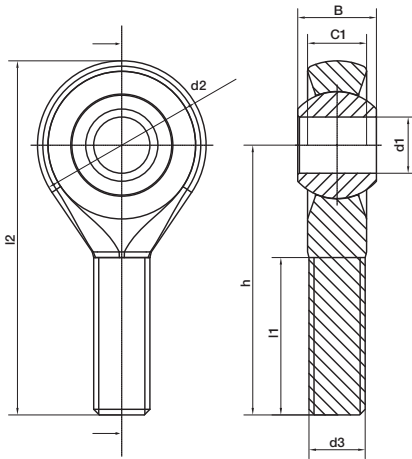

Dimensions (mm)

Part No.	d1 (E10)	d2	d3	C1	B	h	l1	l2	Max. pivot angle	Weight (g)
KARM-06 CL	6	20	M06	7.0	9.0	36	21	46	40°	3.5
KARM-08 CL	8	24	M08	9.0	12.0	42	25	55	35°	6.2
KARM-10 CL	10	30	M10	10.5	14.0	48	28	63	35°	11.2
KARM-12 CL	12	34	M12	12.0	16.0	54	32	71	35°	15.6

► Tolerance Table, Page 1.14

Load Data

Part No.	Maximum static tensile strength		Maximum radial load		Minimum thread depth (mm)	Max. torque strength Outer thread (ft•lbs)	Max. torque though Ball	
	Short term (lbs)	Long term (lbs)	Short term (lbs)	Long term (lbs)			Standard (ft•lbs)	MH (ft•lbs)
KARM-06 CL	225	113	22	11	15	.37	7.37	11.06
KARM-08 CL	382	191	45	22	18	1.48	8.85	29.50
KARM-10 CL	562	281	68	34	20	3.69	14.75	36.88
KARM-12 CL	607	304	90	45	22	4.43	22.13	51.63

For rod end bearings with metal sleeve please add **MH** to the part number, e.g. KABM-10 CL **MH**.

For another spherical bearing material please add **J**, or **R** to the part number, e.g. KARM-10 CL **J**.

Internet: <http://www.igus.com>
email: sales@igus.com
QuickSpec: <http://www.igus.com/iglide-quickspec>

igubal® Spherical Bearings Rod Ends - mm - EARM / EALM

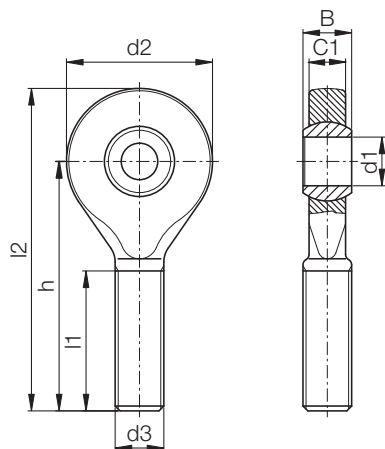

Material:

Housing - igumid G

Ball - iglide® L280

Also available :

iglide® R, iglide® J and iglide® J4

See Section 40 for ball material information

igubal® Rod Ends

Dimensions (mm)

Part No. Right thread	Part No. Left thread	d1 (E10)	d2	d3	C1	B	h	l1	l2	Max. Pivot angle	Weight (g)
EARM-05	EALM-05	5	19	M05	4.4	6	36	20	45.5	33°	2.2
EARM-06	EALM-06	6	21	M06	4.4	6	36	20	46.5	27°	2.5
EARM-08	EALM-08	8	24	M08	6.0	8	41	24	53.0	24°	7.0
EARM-10	EALM-10	10	29	M10	7.0	9	47.5	27	62.0	24°	14.0
EARM-10 F	EALM-10 F	10	29	M10 x 1.25	7.0	9	47.5	27	62.0	24°	14.0
EARM-12	EALM-12	12	34	M12	8.0	10	54	29	71.0	21°	25.0
EARM-12 F	EALM-12 F	12	34	M12 x 1.25	8.0	10	54	29	71.0	21°	25.0
EARM-15	EALM-15	15	40	M14	10.0	12	63	34	83.0	21°	30.0
EARM-17	EALM-17	17	46	M16	11.0	14	69	37	92.0	21°	35.0
EARM-17 F	EALM-17 F	17	46	M16 x 1.5	11.0	14	69	37	92.0	18°	35.0
EARM-20	EALM-20	20	53	M20 x 1.5	13.0	16	80	43	106.5	16°	40.0
EARM-20 M20	EALM-20 M20	20	53	M20 x 2.5	13.0	16	80	43	106.5	16°	40.0
EARM-25	EALM-25	25	64	M24 x 2.0	17.0	20	97	53	129.0	16°	55.0
EARM-30	EALM-30	30	73	M30 x 2.0	19.0	22	113	65	149.5	13°	70.0

► Tolerance Table, Page 1.14

Load Data

Part No. Right thread	Part No. Left thread	Max. static Tensile Strength		Max. Radial Load		Min. Thread Depth (mm)	Max. Torque Strength Outer thread (ft•lbs)	Max. Torque through Ball (ft•lbs)
		Short-term (lbs)	Long-term (lbs)	Short-term (lbs)	Long-term (lbs)			
EARM-05	EALM-05	123	61	11	5	14	.3	1.5
EARM-06	EALM-06	191	95	18	9	14	.4	1.8
EARM-08	EALM-08	359	179	33	16	17	1.5	5.2
EARM-10	EALM-10	584	292	56	28	19	3.7	10.3
EARM-10 F	EALM-10 F	584	292	56	28	19	2.2	10.3
EARM-12	EALM-12	674	337	67	33	20	4.4	18.4
EARM-12 F	EALM-12 F	674	337	67	33	20	4.4	18.4
EARM-15	EALM-15	1011	505	89	45	24	9.2	22.1
EARM-17	EALM-17	1124	562	112	56	26	12.9	25.8
EARM-17 F	EALM-17 F	1124	562	112	56	26	15.5	25.8
EARM-20	EALM-20	1461	730	134	67	30	22.1	29.5
EARM-20 M20	EALM-20 M20	1461	730	134	67	30	18.4	29.5
EARM-25	EALM-25	1910	955	179	89	37	33.2	40.6
EARM-30	EALM-30	2248	1124	224	112	46	62.7	51.6

For another spherical bearing material please add **J**, or **R** to the part number, e.g. EARM-10 **J**.

PDF: www.igus.com/iglide-pdfs
CAD: www.igus.com/iglide-CAD
RoHS info: www.igus.com/RoHS

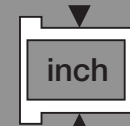



igubal® Spherical Bearings Rod Ends - mm - EARM HT / EALM HT

The EARMHT / EALM HT version is for those applications with higher temperature requirements

igubal® Rod Ends

Telephone 1-800-521-2747
Fax 1-401-438-7270

Special properties

- For temperatures up to 392 °F

Material:

Housing - iguton G
Ball - iglide® T500
See Section 40 for ball material information

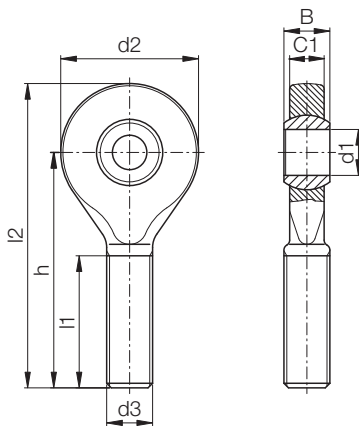

Dimensions (mm)

Part No. Right thread	Part No. Left thread	d1 (E10)	d2	d3	C1	B	h	l1	l2	Max. pivot angle	Weight (g)
EARM-05 HT	EALM-05 HT	5	19	M05	4.4	6	36	20	45.5	33°	2.8
EARM-06 HT	EALM-06 HT	6	21	M06	4.4	6	36	20	46.5	27°	3.4
EARM-08 HT	EALM-08 HT	8	24	M08	6.0	8	41	24	53.0	24°	6.1
EARM-10 HT	EALM-10 HT	10	29	M10	7.0	9	47.5	27	62.0	24°	10.2
EARM-12 HT	EALM-12 HT	12	34	M12	8.0	10	54	29	71.0	21°	15.7

► Tolerance Table, Page 1.14

Internet: <http://www.igus.com>
email: sales@igus.com
QuickSpec: <http://www.igus.com/iglide-quickspec>

igubal® Spherical Bearings Rod End Accessories Adjusting Bolt - mm - PKRM / PKLM



Special properties

- Combined with rod end bearings of the dimensional series K
- Available in left and right threads

Material: igumid G

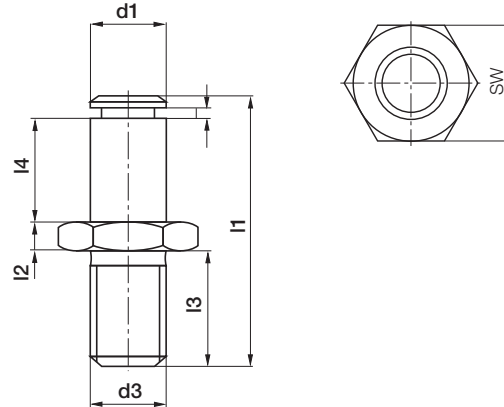

Dimensions (mm)

Part No.	Part No.	d1	d3	l1	l2	l3	l4	SW	Weight
Right thread	Left thread	h11 (mm)	Connection thread	Total Length (mm)	Nut Width (mm)	Thread Length (mm)	Length Adjusting Bolt (mm)	Width across Flats	(g)
PKRM-05	PKLM-05	5	M05	25.0	2.7	11.3	8.5	SW 8	0.7
PKRM-06	PKLM-06	6	M06	28.0	3.2	12.8	9.5	SW 10	1.2
PKRM-08	PKLM-08	8	M08	32.0	4.0	12.5	12.5	SW 13	2.6
PKRM-10	PKLM-10	10	M10	37.5	5.0	14.5	14.5	SW 16	4.0
PKRM-12	PKLM-12	12	M12	42.0	6.0	15.5	16.5	SW 18	7.5
PKRM-14	PKLM-14	14	M14	47.0	7.0	15.5	19.5	SW 21	11.4
PKRM-16	PKLM-16	16	M16	52.0	8.0	16.5	22.0	SW 24	16.9
PKRM-18	PKLM-18	18	M18 x 1.5	59.0	9.0	20.5	24.0	SW 27	16.9
PKRM-20	PKLM-20	20	M20 x 1.5	67.0	10.0	25.0	26.0	SW 30	34.4

► Tolerance Table, Page 1.14

Load Data

Part No.	Part No.	Max. Static Tensile Strength		Max. Static Radial Load	
		Short term	Long term	Short term	Long term
Right thread	Left thread	(lbs)	(lbs)	(lbs)	(lbs)
PKRM-05	PKLM-05	22	11	45	22
PKRM-06	PKLM-06	33	17	56	28
PKRM-08	PKLM-08	56	28	90	45
PKRM-10	PKLM-10	112	56	135	67
PKRM-12	PKLM-12	157	79	202	101
PKRM-14	PKLM-14	179	90	247	124
PKRM-16	PKLM-16	202	101	314	157
PKRM-18	PKLM-18	179	90	382	191
PKRM-20	PKLM-20	112	56	494	247

Available for delivery
Imperial sizes available. Minimum quantities may be required.

► Tolerance Table, Page 1.14

PDF: www.igus.com/iglide-pdfs
CAD: www.igus.com/iglide-CAD
RoHS info: www.igus.com/RoHS





igubal® Spherical Bearings Rod End Accessories WGRM / WGLM Ball & Socket Joint - Elbow

igubal® Rod Ends

Telephone 1-800-521-2747
Fax 1-401-438-7270

Internet: <http://www.igus.com>
email: sales@igus.com
QuickSpec: <http://www.igus.com/iglide-quickspec>



Special properties

- Connection for rotating and oscillating movement
- Easy and fast mounting

Material:

Housing - igumid G
Cap - iglide® L280

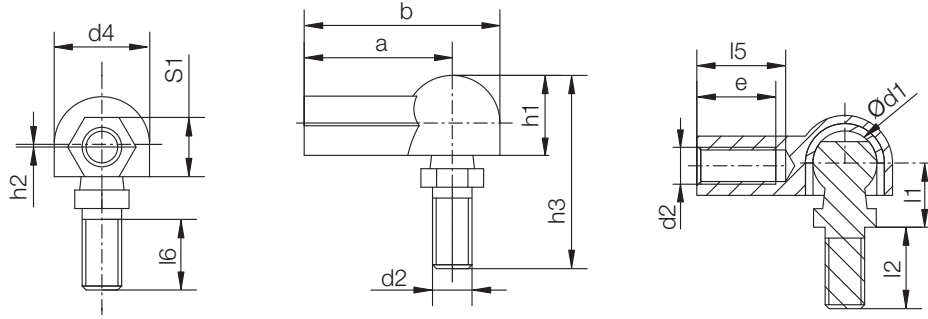

Dimensions (mm)

Part No. Right thread	Part No. Left thread	d1 ±0.1	d2	d4 ±0.5	l1 ±0.2	l2 ±0.3	l5	l6 min.	h1 ±0.4	h2 ±0.5	h3 ±0.5	a ±0.3	b ±0.5	e ±0.5	S1	max. pivot angle
WGRM-05	WGLM-05	8.0	M5	12.8	9.0	10.2	14.0	8.2	10.8	0.65	25.6	22.0	28.4	11.0	SW 8	25°
WGRM-06	WGLM-06	10.0	M6	14.8	11.0	12.5	16.0	10.5	12.3	0.70	30.9	25.0	32.4	13.0	SW 9	25°
WGRM-08	WGLM-08	13.0	M8	19.3	13.0	16.5	18.0	13.5	16.2	1.15	38.8	30.0	39.7	16.0	SW 12	25°
WGRM-10	WGLM-10	16.0	M10	24.0	16.0	20.0	20.0	16.0	20.0	1.15	47.0	35.0	47.0	18.0	SW 14	25°

*MS = metal stud; example: WGRM-05 MS

Load data

Part No. Right thread	Part No. Left thread	max. axial tensile force ball stud axis		max. axial compressive force ball stud axis		max. axial tensile force housing axis		Max. axial tensile force in housing axis with metal ball stud		Weight (g)
		Short term (lbs)	Long term (lbs)	Short term (lbs)	Long term (lbs)	Short term (lbs)	Long term (lbs)	Short term (lbs)	Long term (lbs)	
WGRM-05	WGLM-05	7	3	45	22	22	11	135	67	2.6
WGRM-06	WGLM-05	8	4	67	34	31	16	180	90	4.0
WGRM-08	WGLM-05	56	28	112	56	45	22	337	169	8.2
WGRM-10	WGLM-05	56	28	202	101	90	45	427	214	13.8

igubal® Spherical Bearings
Rod End Accessories WGRM LC / WGLM LC
Low Cost Ball & Socket Joint - Elbow



Special properties

- LC (low cost) version is a two piece assembly with a metal pin

Material:

Housing - igamid G

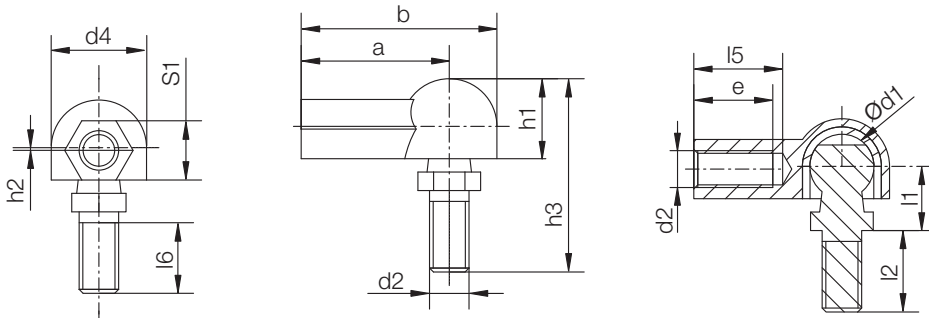

Dimensions (mm)

Part No. Right thread	Part No. Left thread	d1 ±0.1	d2	d4 ±0.5	l1 ±0.2	l2 ±0.3	l5	l6 min.	h1 ±0.4	h2 ±0.5	h3 ±0.5	a ±0.3	b ±0.5	e ±0.5	S1	max. pivot angle
WGRM-05 LC	WGLM-05 LC	8.0	M5	12.8	9.0	10.2	14.0	8.2	10.8	0.65	25.6	22.0	28.4	11.0	SW 8	25°
WGRM-06 LC	WGLM-06 LC	10.0	M6	14.8	11.0	12.5	16.0	10.5	12.3	0.70	30.9	25.0	32.4	13.0	SW 9	25°
WGRM-08 LC	WGLM-08 LC	13.0	M8	19.3	13.0	16.5	18.0	13.5	16.2	1.15	38.8	30.0	39.7	16.0	SW 12	25°
WGRM-10 LC	WGLM-10 LC	16.0	M10	24.0	16.0	20.0	20.0	16.0	20.0	1.15	47.0	35.0	47.0	18.0	SW 14	25°

*** MS = metal ball stud For example: WGRM-05 LC MS

Load data

Part No. Right thread	Part No. Left thread	max. axial tensile force ball stud axis		max. axial compressive force ball stud axis		max. axial tensile force housing axis		Max. axial tensile force in housing axis with metal ball stud		Weight (g)
		Short term (lbs)	Long term (lbs)	Short term (lbs)	Long term (lbs)	Short term (lbs)	Long term (lbs)	Short term (lbs)	Long term (lbs)	
WGRM-05 LC	WGLM-05 LC	7	3	45	22	22	11	135	67	2.6
WGRM-06 LC	WGLM-05 LC	8	4	67	34	31	16	180	90	4.0
WGRM-08 LC	WGLM-05 LC	56	28	112	56	45	22	337	169	8.2
WGRM-10 LC	WGLM-05 LC	56	28	202	101	90	45	427	214	13.8

igubal® Rod Ends

PDF: www.igus.com/iglide-pdfs
CAD: www.igus.com/iglide-CAD
RoHS info: www.igus.com/RoHS

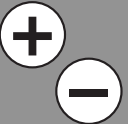



igubal® Spherical Bearings Rod Ends Accessories AGRM / AGLM - AGRM LC / AGLM LC

igubal® Rod Ends

Telephone 1-800-521-2747
Fax 1-401-438-7270



Special properties

- For all mechanical combinations
- Very easy assembling by hand
- Proportion from cohesion to assembling force ca. 10:1

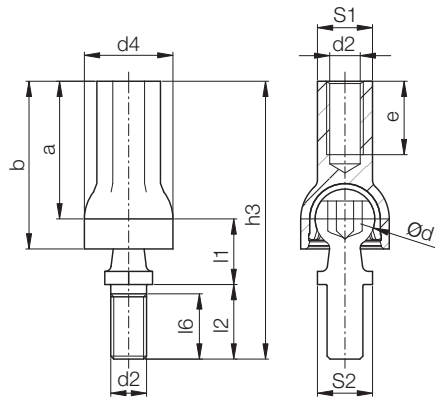

Material:
Housing - igumid G
Cap - iglide® L280

Dimensions (mm)

Part No.		d1	d2	d4	l1	l2	l6	h3	a	b	e	S1	S2	pivot angle	
Right thread	Left thread	±0.1		±0.5	±0.2	±0.3		±0.3	±0.5	min.				Recom.	max.
AGRM-08	AGRM-08	13.0	M8	19.3	13.0	16.5	13.5	59.0	29.5	36.5	16.0	SW12	SW11	18°	25°

Load data

Part No.		max. static axial tensile strength		max. static axial compressive strength		max. assembling force	Weight
		short term	long term	short term	long term		
Right thread	Left thread	(lbs)	(lbs)	(lbs)	(lbs)	(lbs)	(g)
AGRM-08	AGLM-08	56	28	225	112	25	7.8

Internet: <http://www.igus.com>
email: sales@igus.com
QuickSpec: <http://www.igus.com/iglide-quickspec>



Special properties

- For all mechanical combinations
- Very easy assembling by hand
- Proportion from cohesion to assembling force ca. 10:1

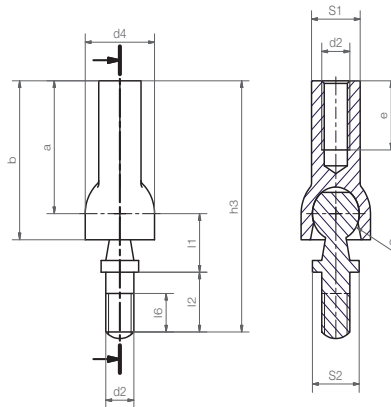

Material:
Housing - igumid G

Dimensions (mm)

Part No.		d1	d2	d4	l1	l2	l6	h3	a	b	e	S1	S2	pivot angle	
Right thread	Left thread	±0.1		±0.5	±0.2	±0.3		±0.3	±0.5	min.				Recom.	max.
AGRM-08 LC	AGRM-08 LC	10.0	M6	14.8	11.0	11.3	7.3	47.3	25.0	29.9	13.0	SW9	10.0	18°	25°

Load data

Part No.		max. static axial tensile strength		max. static axial compressive strength		Weight
		short term	long term	short term	long term	
Right thread	Left thread	(lbs)	(lbs)	(lbs)	(lbs)	(g)
AGRM-08 LC	AGLM-08 LC	22	11	450	225	10.8

igus[®]



igubal[®]
Clevis Joint



Available Components

Available Styles



E Series

Clevis Joint

- Available in left- or right-hand thread
- High tensile strength
- Vibration dampening

GERI/GELI - inch
Page 36.5

GERM/GELM - metric
Page 36.6



E Series

Clevis Joint with Clevis Pin and Circlip

- Available in left- or right-hand thread
- Can be used in combination with Series E rod ends

GERIK/GELIK - inch

Page 36.7

GERMK/GELMK - metric
Page 36.8



E Series

Clevis Joint with Clevis Pin, Circlip and Rod End

- Available in left- or right-hand thread
- Universal corrosion resistance

GERMKE/GELMKE - metric

Page 36.9



E Series

Clevis Joint with Spring Loaded Pin

- Available in left- or right-hand thread
- Easy assembly in hard to reach locations

GERMF/GELMF - metric

Page 36.10



Clevis Joint with Spring Loaded Pin and Rod End

- Available in left- or right-hand thread
- Lightweight

GERMFE/GELMFE - metric

Page 36.11



K Series

Spring Loaded Pin (as separate part)

Clevis Pin (as separate part)

Circlip (as separate part)

- Easy to assemble
- Lightweight

GEFM - Spring loaded pin - metric
Page 36.9

GBM - Clevis pin - metric

GSR - Circlip - metric

Page 36.12

igubal® Spherical Bearings Clevis Joint Application Examples



Typical industries and applications

- Food industry
- Heavy duty
- Packaging
- Automotive
- Disposal Engineering
- Automation, etc.

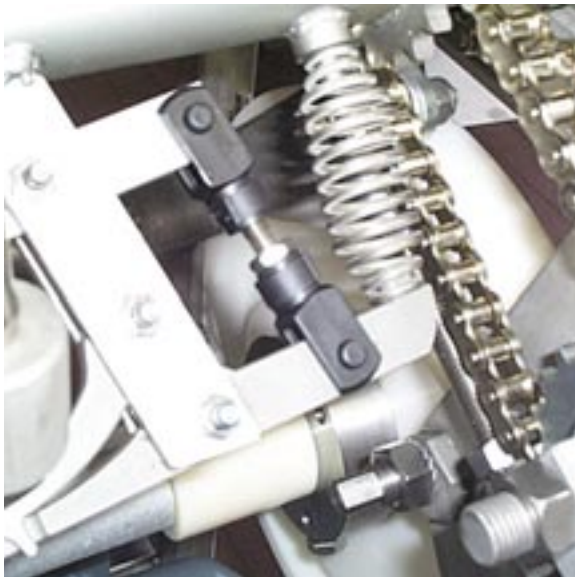

Both the housing material and the universal ball joint are made of materials that are safe in food environments



Packaging industry



A low-cost alternative to stainless steel: igubal® clevis joints combinations made of plastic



Pneumatic cylinder



igubal® Spherical Bearings Clevis Joint

Product Range

- Female threads
- Left hand and right hand threads
- Diameters from 4–20 mm
- With bold and clip or spring loaded pin
- Combination with dimensional Series E

Part Number Structure

Part Number Structure

G E R M K E - 1 2 F

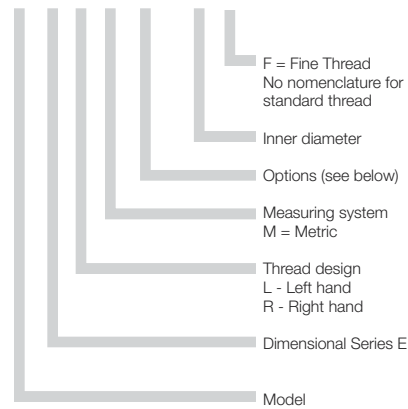

Options:

- K = with clevis pin and clip
- KE = with clevis pin, clip and rod end bearing
- F = with spring-loaded clasp pin
- FE = with spring-loaded clasp pin and rod end bearing



Advantages

- Maintenance-free, dry running
- Self-lubricating
- High strength under impact loads
- Compensation for alignment errors
- Compensation for edge loads
- Chemically resistant
- Vibration damping
- Suitable for rotating, oscillating and linear movements
- High radial loads
- Can be used in liquid media
- Space-saving design
- Easy to install
- Predictable lifetime
- Maintenance-free, lubrication-free

General information

igubal® clevis joints are made of igumid G according to DIN 71752. The clevis joints are available in a variety of configurations. igubal® clevis joints can be used in difficult circumstances without any problems. The clevis joints are corrosion resistant in moist or wet environments and the sliding bearings are resistant to weak acids and alkalis. The operating temperatures range from -22°F to +176°F. igubal® clevis joints are made out of a high-wear resistant material which requires no lubrication.

Loads

The load-bearing capacity of the maintenance-free, polymer clevis joints is very high at normal ambient temperatures. They absorb high forces, possess very good vibration dampening properties and yet weigh only a fifth of conventional metallic bearing housings. However, plastic specific properties, such as dependence on temperature and behavior under long term stressing, must be taken into consideration when using the clevis joints. The load-bearing capacity of the clevis joints in individual cases should therefore be checked in a practical test, particularly if they are to be used under continuously high loads and at elevated temperatures.

Chemical Resistance

igubal® clevis joints are resistant to weak alkalis and weak acids, as well as to fuels and all types of lubricants. Please contact us if you have any questions about the resistance of our igubal® bearings.

Usage Guidelines



- If high rigidity is required
- If corrosion resistance is required
- In applications where lubrication could present an issue
- If simple assembly is necessary
- If a lightweight option is preferred



- If temperatures are higher than 248°F
- If dimensions above 1" or 30 mm are necessary

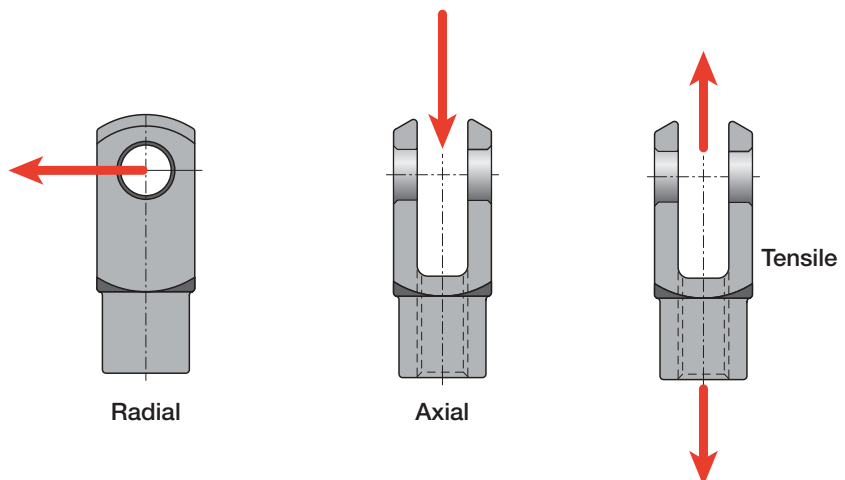

igubal® Spherical Bearings
Clevis Joint
GERI / GELI - inch

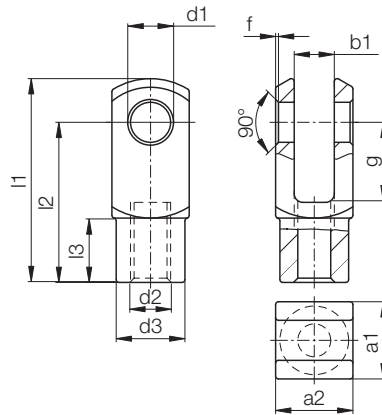

Material:
igumid G

igubal® Clevis Joint

Dimensions (inch)

Right (Left) Thread	d1 H9	g h11	a1	a2 +0.3 -0.16	b1	d2 Thread- Tolerance 6H	d3 +0.3 -0.3	f +0.3 -0.3	l1 +0.5 -0.5	l2 +0.3 -0.3	l3 +0.2 -0.2
GER(L)I-03	0.1875	0.394	0.394	0.394	0.197	10-32	0.354	.02	1.024	0.787	0.295
GER(L)I-04	0.2500	0.472	0.472	0.472	0.236	1/4-28	0.394	.02	1.205	0.945	0.354
GER(L)I-05	0.3125	0.630	0.630	0.630	0.315	5/16-24	0.551	.02	1.638	1.260	0.472
GER(L)I-06	0.3750	0.787	0.787	0.787	0.394	3/8-24	0.709	.02	2.020	1.575	0.591
GER(L)I-07	0.4375	0.945	0.945	0.945	0.472	7/16-20	0.787	.02	2.413	1.890	0.709
GER(L)I-08	0.5000	1.102	1.063	1.063	0.551	1/2-20	0.945	.02	2.807	2.205	0.886

Load Data

Right (Left) Thread	Max. Static Axial Tensile Strength GERI		Weight (g)
	Short-term (lbs)	Long-term (lbs)	
GER(L)I-03	225	112	1.6
GER(L)I-04	270	135	2.9
GER(L)I-05	607	303	6.1
GER(L)I-06	1056	528	13.0
GER(L)I-07	1281	640	16.5
GER(L)I-08	719	360	20.8

► Tolerance Table, Page 1.14

PDF: www.igus.com/iglide-pdfs
CAD: www.igus.com/iglide-CAD
RoHS info: www.igus.com/RoHS

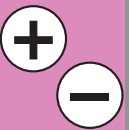



igubal® Spherical Bearings Clevis Joint GERM/GELM - mm

igubal® Clevis Joint

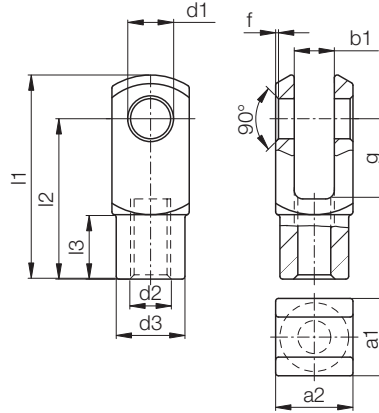

Material:
igumid G

Dimensions (mm)

Right (Left) Thread	d1 H9	g h11	a1	a2 +0.3 -0.16	b1	d2 Thread- Tolerance 6H	d3 +0.3 -0.3	f +0.3 -0.3	l1 +0.5 -0.5	l2 +0.3 -0.3	l3 +0.2 -0.
GER(L)M-04	4	8	8	8	4	M4	8.0	0.5	21.0	20	7.5
GER(L)M-05 DIN M4	5	10	10	10	5	M04	9	0.5	25.5	20	7.5
GER(L)M-05 DIN M5	5	10	10	10	5	M04	9	0.5	25.5	20	7.5
GER(L)M-05	5	12	12	12	6	M05	10.0	0.5	30.6	24.0	9.0
GER(L)M-06	6	12	12	12	6	M06	10.0	0.5	30.6	24.0	9.0
GER(L)M-08	8	16	16	16	8	M08	14.0	0.5	41.6	32.0	12.0
GER(L)M-10	10	20	20	20	10	M10	18.0	0.5	51.3	40.0	15.0
GER(L)M-10 F	10	20	20	20	10	M10x1.25	18.0	0.5	51.3	40.0	15.0
GER(L)M-12	12	24	24	24	12	M12	20.0	0.5	61.3	48.0	18.0
GER(L)M-12 F	12	24	24	24	12	M12x1.25	20.0	0.5	61.3	48.0	18.0
GER(L)M-14	14	28	27	27	14	M14	24.0	0.5	71.3	56.0	22.5
GER(L)M-15	15	28	27	27	14	M14	24.0	0.5	71.3	56.0	22.5
GER(L)M-16	16	32	32	32	16	M16	26.0	1.0	81.9	64.0	24.0
GER(L)M-16 F	16	32	32	32	16	M16x1.5	26.0	1.0	81.9	64.0	24.0
GER(L)M-20	20	40	40	40	20	M20x1.5	34.0	1.0	105.0	80.0	30.0
GER(L)M-20	20	40	40	40	20	M20x2.5	34.0	1.0	105.0	80.0	30.0

Imperial sizes available. Minimum quantities may be required.

➤ Tolerance Table, Page 1.14

Load Data

Right (Left) Thread	Max. Static Tensile Strength GERM		Weight (g)
	Short-term (lbs)	Long-term (lbs)	
GER(L)M-04	179	90	0.9
GER(L)M-05 DIN M4	225	112	1.5
GER(L)M-05 DIN M5	225	112	1.5
GER(L)M-05	270	135	1.5
GER(L)M-06	314	157	2.5
GER(L)M-08	607	303	6.3
GER(L)M-10	1056	528	13.2
GER(L)M-10 F	1056	528	13.2
GER(L)M-12	1281	640	20.2
GER(L)M-12 F	1281	640	20.2
GER(L)M-14	1483	741	29.9
GER(L)M-15	719	360	30.0
GER(L)M-16	1686	843	49.9
GER(L)M-16 F	1686	843	49.9
GER(L)M-20	2136	1068	105.0
GER(L)M-20	2136	1068	105.0

Telephone 1-800-521-2747
Fax 1-401-438-7270

Internet: <http://www.igus.com>
email: sales@igus.com
QuickSpec: <http://www.igus.com/iglide-quickspec>

igubal® Spherical Bearings

Clevis Joint with Pin, Clip and rod end - GERIK / GELIK- inch

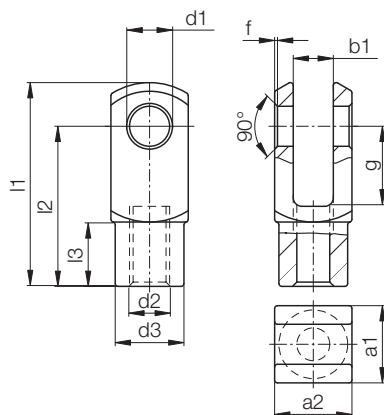

Material:
igumid G

igubal® Clevis Joint

Dimensions (inch)

Right (Left) Thread	d1 H9	g h11	a1	a2 +0.3 -0.16	b1	d2 Thread- Tolerance 6H	d3 +0.3 -0.3	f +0.3 -0.3	l1 +0.5 -0.5	l2 +0.3 -0.3	l3 +0.2 -0.2
GER(L)IK-03	0.1875	0.394	0.394	0.394	0.197	10-32	0.354	.02	1.024	0.787	0.295
GER(L)IK-04	0.2500	0.472	0.472	0.472	0.236	1/4-28	0.394	.02	1.205	0.945	0.354
GER(L)IK-05	0.3125	0.630	0.630	0.630	0.315	5/16-24	0.551	.02	1.638	1.260	0.472
GER(L)IK-06	0.3750	0.787	0.787	0.787	0.394	3/8-24	0.709	.02	2.020	1.575	0.591
GER(L)IK-07	0.4375	0.945	0.945	0.945	0.472	7/16-20	0.787	.02	2.413	1.890	0.709
GER(L)IK-08	0.5000	1.102	1.063	1.063	0.551	1/2-20	0.945	.02	2.807	2.205	0.886

Load Data

Right (Left) Thread	Max. Static Tensile Strength GER(L)IK		Weight (g)
	Short-term (lbs)	Long-term (lbs)	
	GER(L)IK-03	180	
GER(L)IK-04	202	101	3.5
GER(L)IK-05	472	236	7.7
GER(L)IK-06	674	404	16.0
GER(L)IK-07	787	393	21.4
GER(L)IK-08	629	315	26.3

► Tolerance Table, Page 1.14

PDF: www.igus.com/iglide-pdfs
CAD: www.igus.com/iglide-CAD
RoHS info: www.igus.com/RoHS

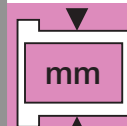
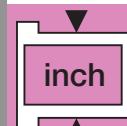



igubal® Spherical Bearings Clevis Joint with Pin and Clip GERMK/GELMK - mm

igubal® Clevis Joint

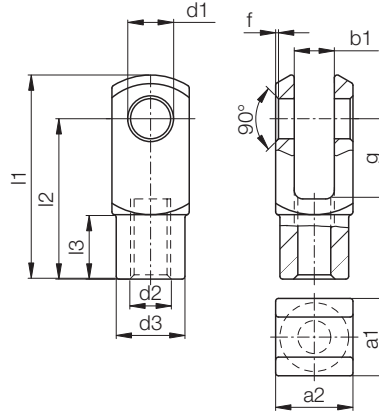

Material:
igumid G

Dimensions (mm)

Right (Left) Thread	d1 H9	g h11	a1	a2 +0.3 -0.16	b1	d2 Thread- Tolerance 6H	d3 +0.3 -0.3	f +0.3 -0.3	l1 +0.5 -0.5	l2 +0.3 -0.3	l3 +0.2 -0.
GER(L)MK-04	4	8	8	8	4	M4	8.0	0.5	21.0	20	7.5
GER(L)MK-05 DIN M4	5	10	10	10	5	M04	9	0.5	25.5	20	7.5
GER(L)MK-05 DIN M5	5	10	10	10	5	M04	9	0.5	25.5	20	7.5
GER(L)MK-05	5	12	12	12	6	M05	10.0	0.5	30.6	24.0	9.0
GER(L)MK-06	6	12	12	12	6	M06	10.0	0.5	30.6	24.0	9.0
GER(L)MK-08	8	16	16	16	8	M08	14.0	0.5	41.6	32.0	12.0
GER(L)MK-10	10	20	20	20	10	M10	18.0	0.5	51.3	40.0	15.0
GER(L)MK-10 F	10	20	20	20	10	M10x1.25	18.0	0.5	51.3	40.0	15.0
GER(L)MK-12	12	24	24	24	12	M12	20.0	0.5	61.3	48.0	18.0
GER(L)MK-12 F	12	24	24	24	12	M12x1.25	20.0	0.5	61.3	48.0	18.0
GER(L)MK-14	14	28	27	27	14	M14	24.0	0.5	71.3	56.0	22.5
GER(L)MK-15	15	28	27	27	14	M14	24.0	0.5	71.3	56.0	22.5
GER(L)MK-16	16	32	32	32	16	M16	26.0	1.0	81.9	64.0	24.0
GER(L)MK-16 F	16	32	32	32	16	M16x1.5	26.0	1.0	81.9	64.0	24.0
GER(L)MK-20	20	40	40	40	20	M20x1.5	34.0	1.0	105.0	80.0	30.0
GER(L)MK-20 M20	20	40	40	40	20	M20x2.5	34.0	1.0	105.0	80.0	30.0

► Tolerance Table, Page 1.14

Load Data

Right (Left) Thread	Max. Static Axial Tensile Strength GER(L)MK		Max. Static Radial Load		Weight (g)
	Short-term (lbs)	Long-term (lbs)	Short-term (lbs)	Long-term (lbs)	
GER(L)MK-04	135	67	56	28	1.3
GER(L)MK-05 DIN M4	202	90	56	28	2.1
GER(L)MK-05 DIN M5	180	90	56	28	2.1
GER(L)MK-05	202	101	56	28	3.3
GER(L)MK-06	292	146	67	33	3.3
GER(L)MK-08	472	236	146	73	7.9
GER(L)MK-10	674	404	180	90	16.4
GER(L)MK-10 F	674	404	180	90	16.4
GER(L)MK-12	787	393	202	101	25.3
GER(L)MK-12 F	787	393	202	101	25.3
GER(L)MK-14	1371	685	224	112	31.2
GER(L)MK-15	629	315	224	112	38.9
GER(L)MK-16	1573	786	270	135	60.8
GER(L)MK-16 F	1573	786	270	135	60.8
GER(L)MK-20	2023	1012	674	337	125.2
GER(L)MK-20 M20	2023	1012	674	337	125.2

Telephone 1-800-521-2747
Fax 1-401-438-7270

Internet: <http://www.igus.com>
email: sales@igus.com
QuickSpec: <http://www.igus.com/iglide-quickspec>

igubal® Spherical Bearings Clevis Joint with Pin, Clip and rod end - GERMKE / GELMKE- mm



Material:
igumid G

Load Data

Right-Thread	Left-Thread	Max. Static Tensile Strength		Max. Static Radial Load		Weight (g)
		Short Term (lbs)	Long Term (lbs)	Short Term (lbs)	Long Term (lbs)	
GERMKE-05 M5	GELMKE-05 M5	202	101	34	17	6.4
GERMKE-06	GELMKE-06	292	146	45	22	7.3
GERMKE-08	GELMKE-08	450	225	101	51	14.6
GERMKE-10	GELMKE-10	517	259	112	56	27.1
GERMKE-10 F	GELMKE-10 F	517	259	112	56	27.1
GERMKE-12	GELMKE-12	742	371	124	62	42.7
GERMKE-12 F	GELMKE-12 F	742	371	124	62	42.7
GERMKE-15	GERMKE-15	630	315	180	90	68.4
GERMKE-16	GERMKE-16	1124	562	191	96	86.9
GERMKE-16 F	GERMKE-16 F	1124	562	191	96	86.9
GERMKE-17	GERMKE-17	809	405	247	124	98.3
GERMKE-17 F	GERMKE-17 F	809	405	247	124	98.3
GERMKE-20	GERMKE-20	1619	809	405	202	175.2
GERMKE-20 F	GERMKE-20 F	1619	809	405	202	175.2

igubal® Clevis Joint

PDF: www.igus.com/iglide-pdfs
CAD: www.igus.com/iglide-CAD
RoHS info: www.igus.com/RoHS

igubal® Spring Loaded Pins - mm - GEFM

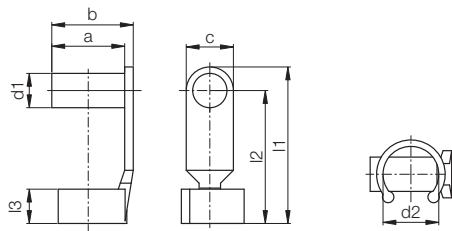

Material:
igumid G

Dimensions (mm)

Part Number	d1 h11	d2	a	b	c	l1 ±0.5	l2	l3	Weight (g)
GEFM-04	4	8	9.5	10.5	8	19	15	4.5	0.5
GEFM-05 DIN	5	9	12	13.5	8	23	19	5.5	0.8
GEFM-05 DIN M5 LS	5	9	12	13.5	8	23	19	5.5	1.0
GEFM-05	5	10	14	15.5	8	27	23	6.5	1.1
GEFM-06 LS	6	10	14	15.5	8	39	35	6.5	1.0
GEFM-06	6	10	14	15.5	8	27	23	6.5	1.2
GEFM-08	8	14	19	21.0	11	35.5	30	8.0	2.8
GEFM-10	10	18	23	25.5	14	45	38	10.0	5.0
GEFM-12	12	20	28	31.0	16	53	45	12.0	8.3
GEFM-16	16	26	36	40.0	22	73	62	16.0	18.3

Imperial sizes available. Minimum quantities may be required.

➤ Tolerance Table, Page 1.14

+

I

inch

mm



igubal® Spherical Bearings
Clevis Joint with Spring Loaded Pin
GERMF/GELMF - mm

igubal® Clevis Joint



Material:
igumid G

Telephone 1-800-521-2747
Fax 1-401-438-7270

Internet: <http://www.igus.com>
email: sales@igus.com
QuickSpec: <http://www.igus.com/iglide-quickspec>

Load Data

Right-Thread	Left-Thread	Max. Static Tensile Strength		Max. Static Radial Load		Weight (g)
		Short Term (lbs)	Long Term (lbs)	Short Term (lbs)	Long Term (lbs)	
GERMF-04 M3.5	GELMF-04 M3.5	112	56	56	28	1.3
GERMF-04	GELMF-04	112	56	56	28	1.3
GERMF-05 DIN M4	GELMF-05 DIN M4	180	90	56	28	2.3
GERMF-05 DIN M5	GELMF-05 DIN M5	180	90	56	28	2.3
GERMF-05 DIN M5 LS	GELMF-05 DIN M5 LS	180	90	56	28	2.3
GERMF-05	GELMF-05	202	101	56	28	3.8
GERMF-06	GELMF-06	292	146	67	34	3.9
GERMF-06 LS	GELMF-06 LS	292	146	29	15	3.9
GERMF-08	GELMF-08	472	236	146	73	9.1
GERMF-10	GELMF-10	674	337	180	90	18.2
GERMF-10 F	GELMF-10 F	674	337	180	90	18.2
GERMF-12	GELMF-12	787	393	202	101	28.6
GERMF-12 F	GELMF-12 F	787	393	202	101	28.6
GERMF-16	GELMF-16	1574	787	270	135	61.8
GERMF-16 F	GELMF-16 F	1574	787	270	135	61.8

igubal® Spherical Bearings
Clevis Joint, Spring Loaded Pin and E-Series Rod End
GERMFE/GELMFE - mm



Material:
Housing - igumid G
Ball - iglide® L280

igubal® Clevis Joint

Load Data

Right-Thread	Left-Thread	Max. Static Tensile Strength		Max. Static Radial Load		Weight (g)
		Short Term (lbs)	Long Term (lbs)	Short Term (lbs)	Long Term (lbs)	
GERMFE-05	GELMFE-05	101	202	34	17	7.0
GERMFE-06	GELMFE-06	146	292	45	22	7.9
GERMFE-08	GELMFE-08	225	450	101	51	15.9
GERMFE-10	GELMFE-10	259	517	112	56	29.2
GERMFE-10 F	GELMFE-10 F	259	517	112	56	29.2
GERMFE-12	GELMFE-12	371	742	124	62	46.0
GERMFE-12 F	GELMFE-12 F	371	742	124	62	46.0
GERMFE-16	GELMFE-16	562	1124	191	96	94.4
GERMFE-16 F	GELMFE-16 F	562	1124	191	96	94.4

PDF: www.igus.com/iglide-pdfs
CAD: www.igus.com/iglide-CAD
RoHS info: www.igus.com/RoHS



igubal® Spherical Bearings Clevis Pin GBI/GBM - inch/mm

igubal® Clevis Joint

Telephone 1-800-521-2747
Fax 1-401-438-7270

Internet: <http://www.igus.com>
email: sales@igus.com
QuickSpec: <http://www.igus.com/iglide-quickspec>

36.12



Material:
Housing - igumid G

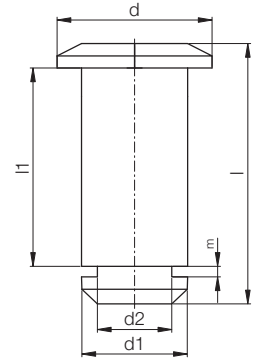

Dimensions (mm)

Part Number Pin	d1	d2	d	l	l1	m	Clip	Weight
GBM-04	4	3.2	7	12.50	8	1.05	GSR-04	0.3
GBM-05	5	4.0	8	16.50	12	1.15	GSR-06	0.5
GBM-05 DIN	5	4.0	8	14.50	10	1.15	GSR-06	0.5
GBM-06	6	4.0	9	16.50	12	1.15	GSR-06	0.7
GBM-08	8	5.0	12	21.50	16	1.15	GSR-08	1.5
GBM-10	10	7.0	15	27.00	20	1.35	GSR-10	3.0
GBM-12	12	9.0	18	31.50	24	1.50	GSR-12	4.8
GBM-14	14	12.0	22	36.00	27	1.70	GSR-16	5.7
GBM-15	15	12.0	23	36.00	27	1.70	GSR-16	8.3
GBM-16	16	12.0	24	42.00	32	1.70	GSR-16	10.4
GBM-17	17	12.0	25	42.00	32	1.70	GSR-16	12.3
GBM-20	20	15.0	30	51.00	40	2.00	GSR-20	19.2

Dimensions (inch)

Part Number Pin	d1	d2	d	l	l1	m	Clip	Weight
GBI-03	.1875	.1260	.3125	.55	.3975	.0472	GSR-04	0.4
GBI-04	.2500	.1969	.3750	.65	.4764	.0512	GSR-08	0.5
GBI-05	.3125	.1969	.4375	.85	.6339	.0512	GSR-08	1.5
GBI-06	.3750	.2756	.5000	1.05	.7953	.0591	GSR-10	2.8
GBI-07	.4375	.3543	.6250	1.25	.9528	.0669	GSR-12	4.6
GBI-08	.5000	.3543	.7500	1.40	1.0709	.0669	GSR-12	5.2

igubal® Clevis Clip GSR - mm



Material:
Housing - igumid G

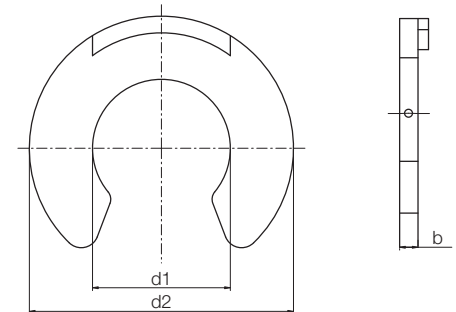

Dimensions (mm)

Part Number	d1	d2	b	Weight
GSR-04	3.20	7.0	1.00	0.05
GSR-06	4.00	9.0	1.10	0.06
GSR-08	5.00	11.0	1.10	0.12
GSR-10	7.00	14.0	1.30	0.16
GSR-12	9.00	18.5	1.40	0.31
GSR-16	12.00	23.0	1.60	0.58
GSR-20	15.00	28.0	1.90	0.96

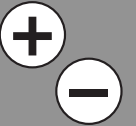



igubal® Spherical Bearings Clevis Joint

igubal® Clevis Joint

Telephone 1-800-521-2747
Fax 1-401-438-7270

Internet: <http://www.igus.com>
email: sales@igus.com
QuickSpec: <http://www.igus.com/iglide-quickspec>



igubal[®]
Pillow Block



Available Materials & Features

Available Styles



K Series

Spherical Ball: iglide[®] L280
Housing: igumid G

- High strength under impact loads
- High vibration dampening

KSTI - inch
Page 37.6

KSTM - metric
Page 37.7



E Series

Spherical Ball: iglide[®] L280
Housing: igumid G

- High radial loads
- Can be used in liquid

ESTM - metric

Page 37.8



E Series

Adapter for Series E Pillow Blocks

- Same depth gauge as metal pillow blocks
- Space-saving

AD-01-ESTM - metric

Page 37.9



E Series

Split Pillow Block/Ball
Spherical Ball: iglide[®] J
Housing: RN33

- Ideal for outdoor use
- low moisture absorption

ESTM-GT - metric

Page 37.10



E Series

Spherical Ball: iglide[®] J
Housing: igumid G

- Lightweight
- Space-saving

ESTM-SL - metric

Page 37.11



K Series

Spherical Ball: iglide[®] J
Housing: RN33

- High rigidity
- Easy assembly and disassembly

KSTM-GT - metric

Page 37.12



Typical industries and applications

- Industrial
- Machine building
- Packaging etc.



Stone processing



Solar industry

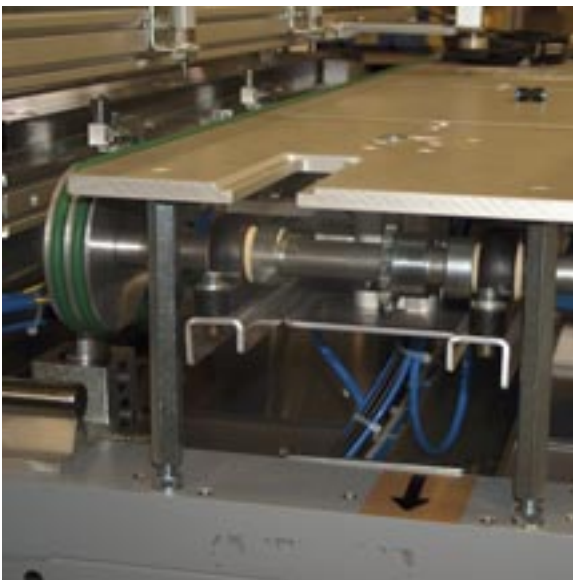

Paper industry



Packaging industry



igubal® Pillow Block Bearing General Information

Product Range

- Closed and split design
- Inner diameters
Inch sizes from: 3/16 to 1 in.
Metric sizes from: 5 to 50 mm

Part Number Structure

Part Number Structure

K ST I - 08

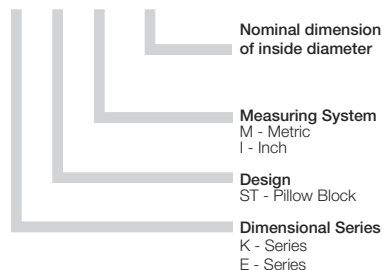

Application Temperatures

Minimum	-22°F
Maximum long-term	+176°F
Maximum short-term	+248°F

Usage Guidelines



- If chemical resistance is required
- When shaft misalignment needs to be resolved
- When easy assembly is requested (see split version)
- When dirt/dust resistant bearings are necessary
- In applications where lubrication could present an issue



- If chemical resistance is required
- When shaft misalignment needs to be resolved
- When easy assembly is requested (see split version)
- When dirt/dust resistant bearings are necessary
- In applications where lubrication could present an issue



The new igubal® pillow block bearings consist of a housing with a bearing insert. igubal® pillow block bearings are especially easy to install, able to compensate for alignment errors and prevent edge loads.

Advantages

- Maintenance-free, dry running
- High rigidity
- High strength under impact loads
- Compensation for alignment errors
- Compensation for edge loads
- Corrosion-free
- Chemically resistant
- Vibration damping
- Suitable for rotating, oscillating and linear movements
- Lightweight
- High radial loads
- Can be used in liquid media
- Space-saving design
- Easy to install
- Predictable lifetime
- Maintenance-free, lubrication-free

Application Use

The ability to pivot allows igubal® pillow block bearings to compensate for misalignment and possible shaft deflection. Applications where these effects cannot be prevented are suited for igubal pillow block bearings.

Tolerances

Maintenance-free igubal® pillow block bearings are designed with inside diameter tolerance of E10. The shaft should be made to tolerance class h6 to h9. These recommended tolerances allow for changes in the bearing due to temperature and moisture absorption. See tolerance table page 1.14.

Mounting

igubal® pillow block bearings are designed for mounting with 2 bolts. Precision mounting of the bearing is not necessary, since the spherical ball compensates for alignment errors.

Product Range

igubal® pillow block bearings are available in the standard dimensions for shafts of 3/16" to 1" or 5 to 50 mm.

Pivot angle

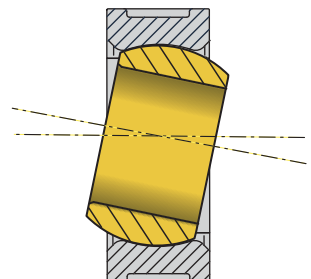

Visit www.igus.com to use our online expert system

igubal® Pillow Block Bearing Axial and Radial Loads



Load

The load capacity of the maintenance-free igubal® bearing elements is very high at normal ambient temperatures. igubal® bearings absorb high forces and weigh only one fifth of traditional, metal bearing housings. The excellent dampening properties are based on the fact that the polymer material of the two part bearing can absorb vibrations differently than steel.

However, plastic specific properties, such as dependence on temperature and behavior under long-term stress, must be taken into consideration when using igubal® bearings. The load capacity of the pillow block should therefore be checked in a practical test, particularly if it will be used under continuous high loads and at elevated temperatures.

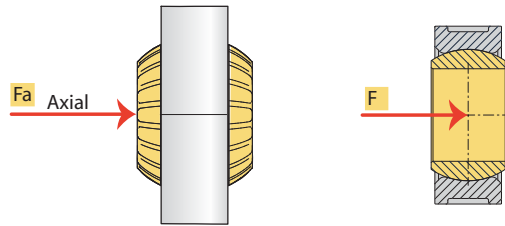

Axial Strength

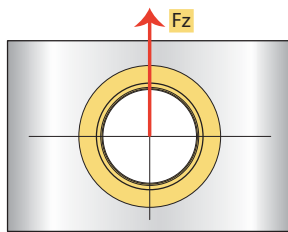

Radial tensile strength
(upward)

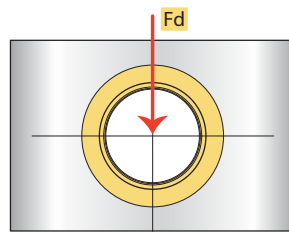

Radial compressive strength
(downward)

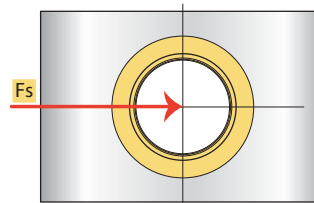

Lateral strength
(radial)





KSTI - Inch

Telephone 1-800-521-2747
Fax 1-401-438-7270

Internet: <http://www.igus.com>
email: sales@igus.com
QuickSpec: <http://www.igus.com/iglide-quickspec>

Material:
Housing - igumid G
Ball - iglide® L280

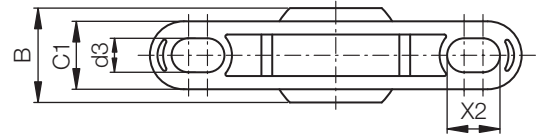
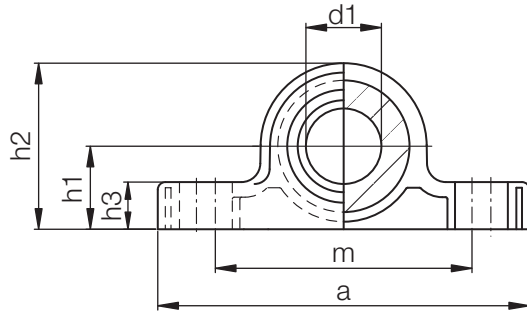

Dimensions (inch)

Part Number	d1 E10	B	C1	h1	h2	h3	a	m	d3	X2	Max. Angle of Pivot
KSTI-03	.1900	.312	.234	.290	.566	.165	1.4000	1.000	.137	.200	25°
KSTI-04	.2500	.375	.250	.390	.705	.205	1.7500	1.250	.137	.250	25°
KSTI-05	.3125	.437	.312	.430	.824	.236	1.9500	1.350	.150	.280	25°
KSTI-06	.3750	.500	.359	.550	1.022	.376	2.4000	1.800	.180	.300	22°
KSTI-07	.4375	.562	.406	.570	1.082	.315	2.5000	1.850	.205	.330	22°
KSTI-08	.5000	.625	.453	.600	1.191	.354	2.8000	2.000	.205	.380	22°
KSTI-10	.6250	.750	.484	.700	1.409	.413	3.3500	2.300	.205	.470	22°
KSTI-12	.7500	.875	.593	.860	1.687	.472	3.7500	2.700	.270	.530	22°
KSTI-16	1.0000	1.375	1.005	1.100	2.163	.630	5.0000	3.500	.520	.680	20°

► Tolerance Table, Page 1.14

Load Data

Part Number	Maximum Static Tensile Strength		Maximum Static Axial Compressive Strength	Maximum Torque for Longitudinal holes	Weight
	Short-term (lbs)	Long-term (lbs)			
KSTI-03	124	62	79	0.4	1.7
KSTI-04	135	67	90	0.4	2.8
KSTI-05	180	90	112	0.6	4.5
KSTI-06	225	112	135	1.0	7.5
KSTI-07	247	124	157	1.8	9.7
KSTI-08	270	135	169	1.8	13.5
KSTI-10	472	236	202	1.8	21.5
KSTI-12	697	348	360	3.3	33.4
KSTI-16	1214	607	495	7.7	85.8

igubal® Pillow Block Bearing KSTM - MM



Material:
Housing - igumid G
Ball - iglide® L280

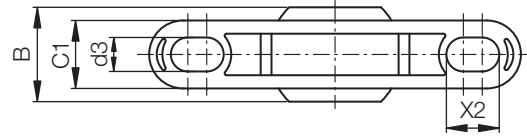
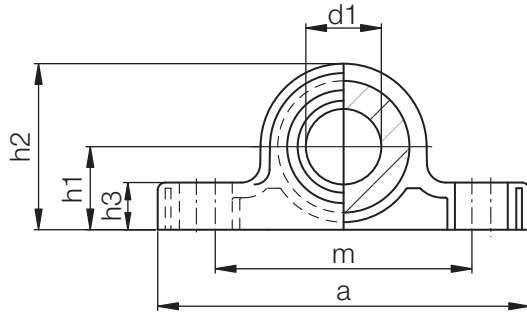

Dimensions (mm)

Part Number	d1 E10	B	C1	h1	h2	h3	a	m	d3	X2	Max. Angle of Pivot
KSTM-05	5	8	6.0	7	14	4	34	25	3.3	5	30°
KSTM-06	6	9	7.0	10	18	5.5	43	33	4.5	6	29°
KSTM-08	8	12	9.0	10	20	6	47	33	4.5	7	25°
KSTM-10	10	14	10.5	14	26	7.5	62	46	5.5	8	25°
KSTM-12	12	16	12.0	14	28	8.5	65	46	5.5	9	25°
KSTM-14	14	19	13.5	18	34	9.5	82	60	6.6	11	23°
KSTM-16	16	21	15.0	18	36	10.5	86	60	6.6	12	23°
KSTM-18	18	23	16.5	22	42	11.5	93	68	9.0	13	23°
KSTM-20	20	25	18.0	22	44	13	98	68	9.0	14	23°
KSTM-22	22	28	20.0	24	48	14	108	74	9.0	16	22°
KSTM-25	25	31	22.0	27	54	16	124	86	9.0	17	22°
KSTM-30	30	37	25.0	32	64	17	139	96	11.0	20	22°

► Tolerance Table, Page 1.14

Load Data

Part Number	Maximum Static Tensile Strength		Maximum Static Axial Compressive Strength	Maximum Torque for Longitudinal holes	Weight
	Short-term (lbs)	Long-term (lbs)			
KSTM-05	157	78	90	0.4	1.7
KSTM-06	247	123	90	1.0	2.9
KSTM-08	292	146	180	1.0	4.6
KSTM-10	337	168	247	1.8	8.6
KSTM-12	494	247	259	1.8	11.8
KSTM-14	539	269	270	3.3	18.4
KSTM-16	674	337	405	3.3	23.7
KSTM-18	786	393	427	7.7	32.2
KSTM-20	1056	528	562	7.7	40.0
KSTM-22	1371	685	607	7.7	54.0
KSTM-25	1483	741	719	7.7	75.3
KSTM-30	1820	910	843	15.9	116.8

KSTM - MM

PDF: www.igus.com/iglide-pdfs
CAD: www.igus.com/iglide-CAD
RoHS info: www.igus.com/RoHS

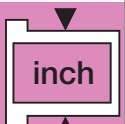



igubal® Pillow Block Bearing ESTM, MM

ESTM - MM



Material:
Housing - igumid G
Ball - iglide® L280

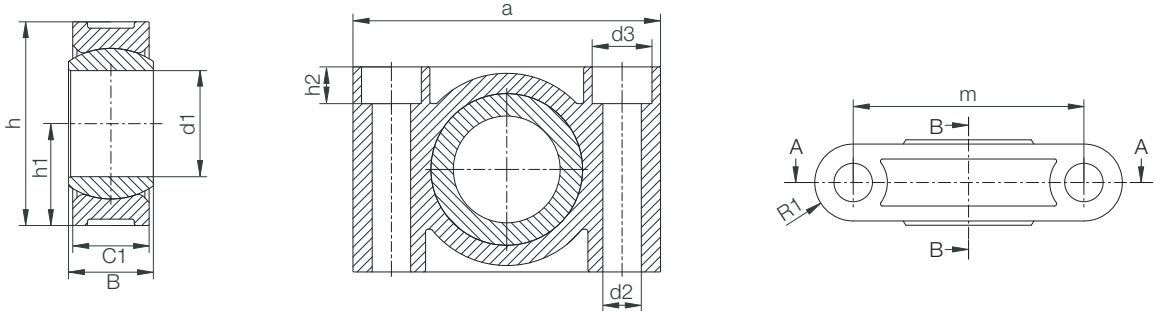

Dimensions (mm)

Part No.	d1 (E10)	d2	d3	h	h1	h2	a	m	C1	B	R1	Max. Angle of Pivot
ESTM-08	8.0	4.5	-	19	9.5	-	31.0	22.0	9.0	8.0	4.5	22°
ESTM-10	10.0	5.5	-	22	11	-	36.0	26.0	10.0	9.0	5.0	22°
ESTM-12	12.0	5.5	-	26	13	-	38.0	28.0	10.0	10.0	5.0	22°
ESTM-16	16.0	6.6	10.6	34	17	6.4	50.0	37.0	13.0	13.0	6.5	22°
ESTM-20	20.0	9.0	14.0	40	20	8.6	62.0	46.0	16.0	16.0	8.0	22°
ESTM-25	25.0	9.0	14.0	48	24	8.6	72.0	54.0	18.0	20.0	9.0	20°
ESTM-30	30.0	11.0	17.0	56	28	10.6	86.0	64.0	22.0	22.0	11.0	20°

► Tolerance Table, Page 1.14

Load Data

Part No.	Max. radial tensile strength		Max. radial compressive strength		Maximum axial strength		Maximum torque bolt holes (ft lbs)	Weight (g)
	Short term (lbs)	Long term (lbs)	Short term (lbs)	Long term (lbs)	Short term (lbs)	Long term (lbs)		
ESTM-08	560	280	965	480	135	65	.95	5.0
ESTM-10	765	380	1190	595	155	80	1.84	7.1
ESTM-12	1010	505	1460	730	165	85	1.84	9.0
ESTM-16	1505	750	1910	955	250	125	3.30	17.5
ESTM-20	1910	955	2470	1290	315	155	3.30	27.4
ESTM-25	3035	1515	4150	2080	515	255	7.75	50.8
ESTM-30*	2250	1125	3710	1855	560	280	7.75	79.7

* Due to the different manufacturing method, the load values of the ESTM-30 are lower than ESTM-25

Telephone 1-800-521-2747
Fax 1-401-438-7270

Internet: <http://www.igus.com>
email: sales@igus.com
QuickSpec: <http://www.igus.com/iglide-quickspec>

igubal® Pillow Block Bearing AD-ESTM, MM



Material:
Housing - igamid G
Ball - iglide® L280

Special properties

- Same dimensions as metallic pillow blocks
- Lightweight
- For E Series pillow blocks
- Corrosion- and chemical-resistant
- Space-saving

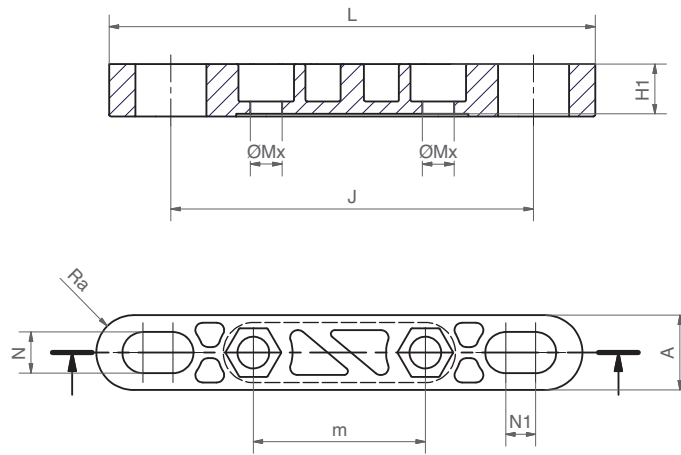
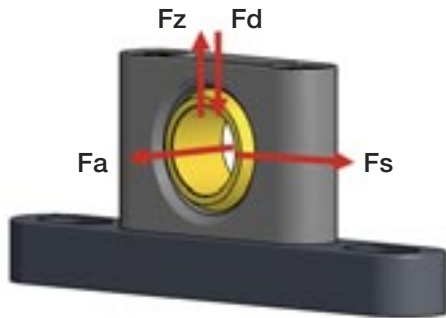

Dimensions [mm]

Part No.	for ESTM-	d1	L	A	Ra	J	H1	N	N1	m	Mx
AD-ESTM-20*	ESTM-20	20	130	20	10	97	14	11	8	46	M8
AD-ESTM-25**	ESTM-25	25	130	20	10	102	12.5	11	9	54	M8
AD-ESTM-30**	ESTM-30	30	158	25	12.5	118	14.9	14	10	64	M10

* Material: plastic

** Material: aluminum

Load data

Part No.	Max. radial tensile strength		Max. radial compressive strength		Maximum axial strength		Maximum lateral strength		Weight (g)
	Short term (lbs)	Long term (lbs)	Short term (lbs)	Long term (lbs)	Short term (lbs)	Long term (lbs)	Short term (lbs)	Long term (lbs)	
AD-01-ESTM-20*	540	270	2,250	1,125	675	335	270	135	29.8
AD-01-ESTM-25**	540	270	2,250	1,125	675	335	270	135	74
AD-01-ESTM-30**	540	270	2,250	1,125	675	335	270	135	124

* Material: plastic

** Material: aluminum

PDF: www.igus.com/iglide-pdfs
CAD: www.igus.com/iglide-CAD
RoHS info: www.igus.com/RoHS



AD-ESTM - MM



ESTM-GT - MM



Special properties

- Save time during assembly and disassembly of shafts, no more threading
- Low installation space and low weight
- High rigidity and fatigue strength
- Adapter available, ► **Page 37.9**

Material:

Housing - RN33

Ball - iglide® J standard

Telephone 1-800-521-2747
1-401-438-7270
Fax

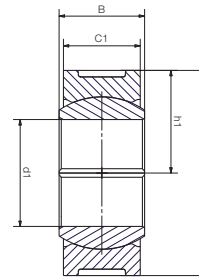
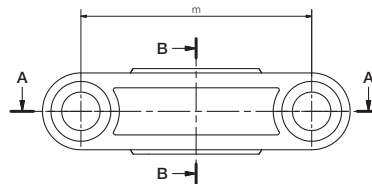
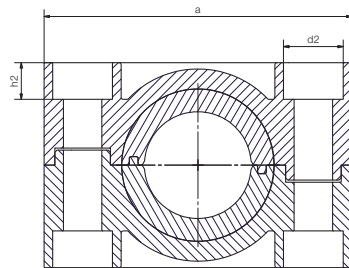

Dimensions [mm]

Part No.	d1	d2	h	h1	h2	a	m	C1	B	R1	Max. pivot Angle
	(E10)										
ESTM-GT16-GT	16.0	10.6	34.0	17.0	6.4	50.0	37.0	13.0	13.0	6.5	22°
ESTM-GT20-GT	20.0	14.0	40.0	20.0	8.6	62.0	46.0	16.0	16.0	8.0	22°
ESTM-GT25-GT	25.0	14.0	48.0	24.0	8.6	72.0	54.0	18.0	20.0	9.0	20°
ESTM-GT30-GT	30.0	11.0	56.0	28.0	10.6	86.0	64.0	22.0	22.0	11.0	22°

► Tolerance Table, Page 1.14

Load Data (mm)

Part No.	Max. static tensile strength		Max. static axial compressive strength		Weight (g)
	Short term	Long term	Short term	Long term	
	(lbs)	(lbs)	(lbs)	(lbs)	
ESTM-GT16-GT	281	165	900	450	18
ESTM-GT20-GT	787	393	1349	674	28
ESTM-GT25-GT	1124	562	787	787	52
ESTM-GT30-GT	1124	618	1124	1124	84

Internet: <http://www.igus.com>
email: sales@igus.com
QuickSpec: <http://www.igus.com/iglide-quickspec>

igubal® Pillow Block Bearing ESTM-XX-SL, MM



Special properties

- Space-saving
- Lightweight
- Maintenance- and lubricant-free
- Predictable lifetime

Material:

Housing - igumid G
Ball - iglide® J standard

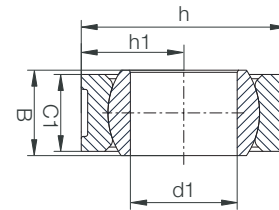
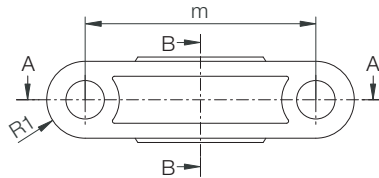
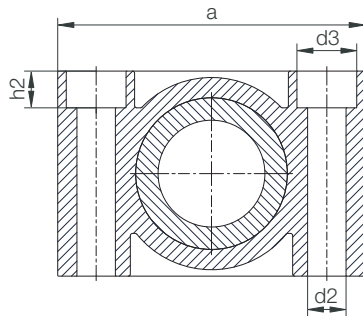

Dimensions (mm)

Part No.	d1 (H10)	d2	h	h1	h2	a	m	C1	Max. Pivot Angle	Weight (g)
ESTM-05-SL	5.0	2.5	18.0	10.0	6.5	16.0	10.0	6.0	17°	1.6
ESTM-06-SL	6.0	2.5	18.0	10.0	6.5	16.0	10.0	6.0	17°	1.7
ESTM-08-SL	8.0	2.5	19.0	10.0	6.5	18.0	12.0	6.0	17°	1.7
ESTM-10-SL	10.0	2.5	20.0	10.0	6.5	20.0	14.0	6.0	17°	1.9

► Tolerance Table, Page 1.14

Load Data (mm)

Part No.	Max. radial tensile strength		Max. radial compressive strength		Maximum lateral strength		Maximum axial strength	
	Short term (lbs)	Long term (lbs)	Short term (lbs)	Long term (lbs)	Short term (lbs)	Long term (lbs)	Short term (lbs)	Long term (lbs)
ESTM-05-SL	337	169	315	157	202	101	34	17
ESTM-06-SL	337	169	315	157	202	101	34	17
ESTM-08-SL	360	180	315	157	214	107	22	11
ESTM-10-SL	360	180	315	157	214	107	22	11

ESTM-XX-SL - MM

PDF: www.igus.com/iglide-pdfs
CAD: www.igus.com/iglide-CAD
RoHS info: www.igus.com/RoHS

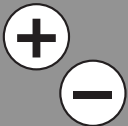



KSTM-GT - MM

Telephone 1-800-521-2747
Fax 1-401-438-7270

Internet: <http://www.igus.com>
email: sales@igus.com
QuickSpec: <http://www.igus.com/iglide-quickspec>

Familiar characteristics such as self-adjustment and zero-maintenance are now available with dimensions of 35, 40, 45 and 50 mm.



Special Properties

- Installation is easy and does not require shaft removal
- Maintenance-free, dry running
- For high static loads
- Space-saving
- Low weight
- High rigidity
- Predictable lifetime

Material:

Housing - RN33
Ball - iglide® J

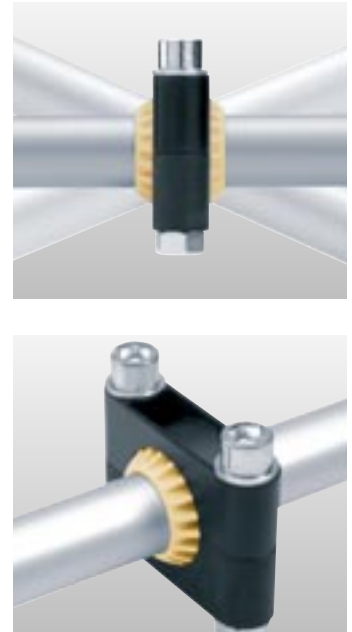
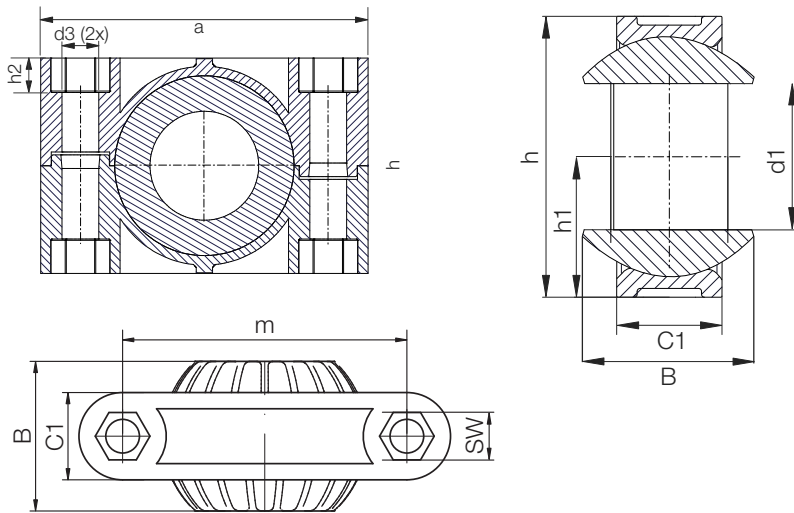

Dimensions (mm)

Part No.	d1 (E10)	d3	h	h1	h2	SW	a	m	C1	B	Max. Pivot Angle
KSTM-GT35*	35.0	13.5	79.0	39.5	12.6	19.0	120.5	91.0	29.5	48.5	24°
KSTM-GT40	40.0	13.5	79.0	39.5	12.6	19.0	120.5	91.0	29.5	48.5	24°
KSTM-GT40 GT**	40.0	13.5	79.0	39.5	12.6	19.0	120.5	91.0	29.5	48.5	24°
KSTM-GT45*	45.0	13.5	100.0	50.0	12.6	19.0	149.0	114.0	35.0	60.0	24°
KSTM-GT50	50.0	13.5	100.0	50.0	12.6	19.0	149.0	114.0	35.0	60.0	24°
KSTM-GT50 GT**	50.0	13.5	100.0	50.0	12.6	19.0	149.0	114.0	35.0	60.0	24°

► Tolerance Table, Page 1.14

Load data

Part No.	Max. radial tensile strength		Max. axial tensile strength		Max. torque		Weight (g)
	Short term (lbs)	Long term (lbs)	Short term (lbs)	Long term (lbs)	through ball (ft lbs)	fixing holes (ft lbs)	
KSTM-GT35*	2,473	1,236	562	281	14.8	11.1	250.3
KSTM-GT40	2,473	1,236	562	281	14.8	11.1	228.4
KSTM-GT40 GT**	2,473	1,236	562	281	14.8	11.1	235.0
KSTM-GT45*	3,372	1,686	674	337	14.8	14.8	405.2
KSTM-GT50	3,372	1,686	674	337	14.8	14.8	370.5
KSTM-GT50 GT**	3,372	1,686	674	337	14.8	14.8	389.2

*Inside diameter achieved with plain iglide® J bearing pressed into ID of spherical ball

**Spherical balls are also available with split design

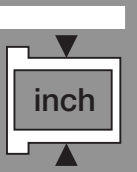
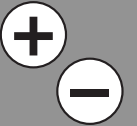



igubal® Pillow Block

Telephone 1-800-521-2747
Fax 1-401-438-7270

Internet: <http://www.igus.com>
email: sales@igus.com
QuickSpec: <http://www.igus.com/iglide-quickspec>



igubal[®] Flange



Available Materials & Features

Available Styles



E Series

Spherical Ball: iglide[®] L280 (standard)
(other options available)
Housing: igumid G

EFOI - inch
Page 38.5

EFOM - metric
Page 38.6



E Series

Spherical Ball: iglide[®] L280 (standard)
(other options available)
Housing: igumid G

EFSI - inch
Page 38.7

EFSM - metric
Page 38.8



K Series

Spherical Ball: iglide[®] J
Housing: RN33

KFSM-GT - metric
Page 38.9



E Series

Spherical Ball: iglide[®] T500
Housing: iguton G
• High temperature option

EFOM-HT - metric
Page 38.10



E Series

Spherical Ball: iglide[®] T500
Housing: iguton G
• High temperature option

EFSM-HT - metric
Page 38.11



Typical industries and applications

- Industrial
- Automation
- Agricultural machines
- Machine building
- Food industry, etc.



Conveyor technique



Solar industry



Rotary sorter



Food industry



igubal®

igubal® Spherical Bearings Flange Technical Data

Product Range

- Flange bearing with 2 and 4 holes
- Dimensional series E
- Diameters from 4 to 50 mm
- Inner diameters:
Inch sizes from 3/8 - 1 in.
Metric sizes from 5 - 50 mm)

Part Number Structure

Part Number Structure

E F O I - 10 - R

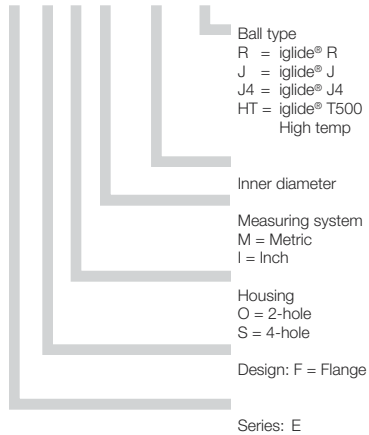

The example shows an inch sized 2-hole flange bearing of the dimensional Series E with a spherical ball inner diameter of 10 mm.

Temperature Range

	Minimum	Maximum
Standard	-22°F	+176°F
High Temp	-40°F	+392°F



- If chemical resistance is required
- If dirt/dust resistant bearings are necessary
- When shaft misalignment needs to be resolved
- In applications where lubrication could present an issue



- If temperatures are higher than +194°F
➤ HT version
- If an integrated fixing collar is required
- If dimensions above 1" or 50 mm are necessary
- If rotation speeds higher than 100 fpm are required



General Properties

igubal® Flange bearings have been developed for the support of shaft ends or for shafts lead-through. Like all igubal® products, these bearings consist of an igumid G housing and an iglide® L280 spherical ball (with other options available). igubal® Flange bearings are made to the dimensional series E and are offered with two or four mounting holes.

Areas of Application

Since igubal® flange bearings are made for maintenance-free use, they are especially suited for applications in which access to the bearing is limited, in moist or wet environments or cleanroom environments. Thus, igubal® flange bearings are also found in electric toothbrushes, awnings, conveyor technology, bakery machines and agriculture to name a few.

Installation

igubal® flange bearings are designed for mounting with 2 or 4 bolts, depending on the design. The 2-hole types are provided with elongated holes, which allow a problem-free adjustment. An exact positioning of the bearing housing is not necessary, since the spherical ball compensates for alignment errors.

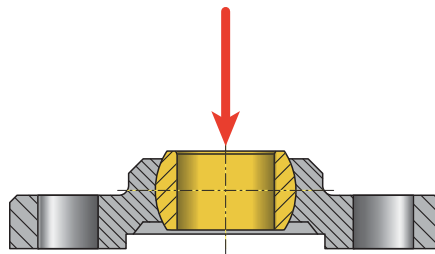

Static axial load

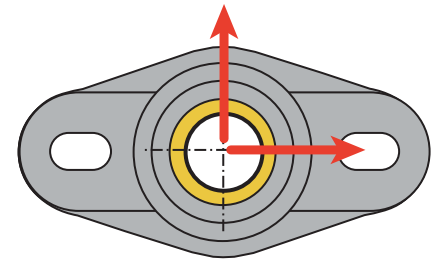

Static radial load

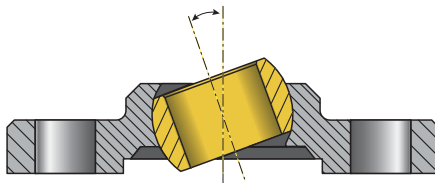

Pivot Angle

igubal® Spherical Bearings Flange Bearing, 2 Hole - inch - EFOI



Flange bearing with
2 mounting holes

Material:

Housing - igumid G

Ball - iglide® L280

Also available :

iglide® R, iglide® J and iglide® J4

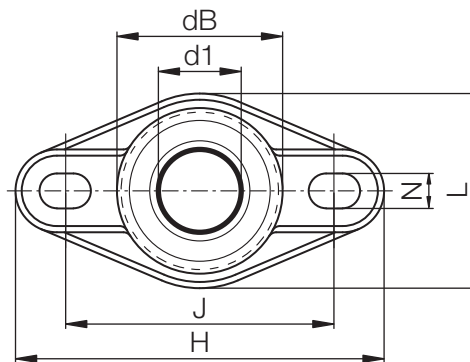
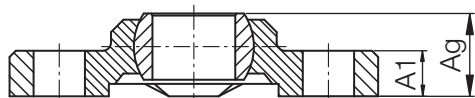

Dimensions (inch)

Part Number	d1 (E10)	dB	H	L	J Hole Pitch	A1 Height of Housing	Ag Total Height	N Bore Diameter d x 1
EFOI-03	0.1900	0.551	1.331	0.630	0.945	0.177	0.312	0.126 x 0.197
EFOI-04	0.2500	0.551	1.331	0.630	0.945	0.177	0.342	0.126 x 0.197
EFOI-05	0.3125	0.709	1.740	0.866	1.220	0.217	0.412	0.169 x 0.256
EFOI-06	0.3750	0.866	2.047	1.024	1.417	0.256	0.483	0.210 x 0.315
EFOI-07	0.4375	0.984	2.232	1.220	1.614	0.276	0.518	0.210 x 0.315
EFOI-08	0.5000	0.984	2.232	1.220	1.614	0.276	0.518	0.210 x 0.315
EFOI-10	0.6250	1.260	2.858	1.496	2.087	0.394	0.683	0.212 x 0.315
EFOI-12	0.7500	1.575	3.504	1.850	2.559	0.433	0.785	0.331 x 0.492
EFOI-16	1.0000	1.909	3.976	2.303	2.953	0.551	0.966	0.331 x 0.492

► Tolerance Table, Page 1.14

Load Data

Part Number	Maximum Static Axial Load		Maximum Static Radial Load		Maximum Static Torque Holes (ft•lbs)	Maximum Pivot angle	Weight (g)
	Short Term (lbs)	Long Term (lbs)	Short Term (lbs)	Long Term (lbs)			
EFOI-03	56	28	168	84	0.44	33°	2.3
EFOI-04	56	28	180	90	0.96	27°	2.0
EFOI-05	156	78	248	124	1.84	24°	4.0
EFOI-06	192	96	450	225	1.84	24°	6.5
EFOI-07	248	124	494	247	1.84	21°	7.5
EFOI-08	248	124	494	247	3.32	21°	12.0
EFOI-10	314	157	630	315	3.32	24°	17.2
EFOI-12	404	202	1236	618	3.32	17°	31.5
EFOI-16	674	337	1348	674	7.74	14°	59.0

For another spherical bearing material please add J, R or J4 to the part number; e.g. EFOI-08R

igubal® Flange

PDF: www.igus.com/iglide-pdfs
CAD: www.igus.com/iglide-CAD
RoHS info: www.igus.com/RoHS

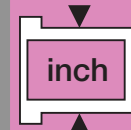
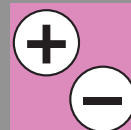



igubal® Spherical Bearings Flange Bearing, 2 Hole - mm - EFOM

igubal® Flange



Flange bearing with
2 mounting holes

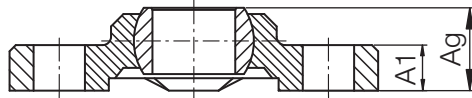

Material:

Housing - igumid G

Ball - iglide® L280

Also available :

iglide® R, iglide® J and iglide® J4

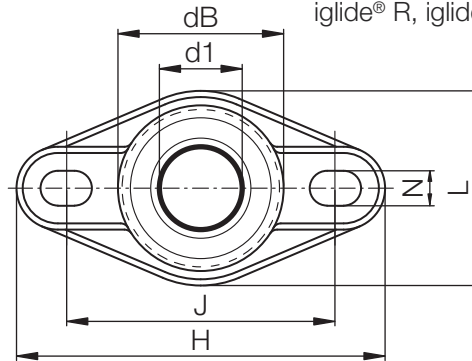

Dimensions (mm)

Part Number	d1 (E10)	dB	H	L	J Hole Pitch	A1 Height of Housing	Ag Total Height	N Bore Diameter d x 1
EFOM-05	5	14.0	33.8	16.0	24.0	4.5	8.5	3.2 x 5.0
EFOM-06	6	14.0	33.8	16.0	24.0	4.5	8.5	3.2 x 5.5
EFOM-08	8	18.0	44.2	22.0	31.0	5.5	10.5	4.3 x 6.5
EFOM-10	10	22.0	52.0	26.0	36.0	6.5	12.0	5.3 x 8.0
EFOM-12	12	25.0	56.7	31.0	41.0	7.0	13.0	5.3 x 8.0
EFOM-15	15	30.0	68.6	36.0	50.0	8.5	15.5	6.4 x 10.0
EFOM-16	16	32.0	72.6	38.0	53.0	10.0	17.5	6.4 x 10.1
EFOM-17	17	35.0	74.6	41.0	55.0	10.0	18.0	6.4 x 10.2
EFOM-20	20	40.0	89.0	47.0	65.0	11.0	20.0	8.4 x 12.5
EFOM-25	25	48.5	101.0	58.5	75.0	14.0	25.0	8.4 x 12.6
EFOM-30	30	55.0	118.0	65.0	87.5	15.0	26.0	10.5 x 16.0

► Tolerance Table, Page 1.14

Load Data

Part Number	Maximum Static Axial Load		Maximum Static Radial Load		Maximum Static Torque Holes (ft•lbs)	Maximum Pivot angle	Weight (g)
	Short Term (lbs)	Long Term (lbs)	Short Term (lbs)	Long Term (lbs)			
EFOM-04	90	45	168	84	0.44	28°	1.9
EFOM-05	90	45	168	84	0.44	29°	2.3
EFOM-06	112	56	180	90	0.44	25°	1.8
EFOM-08	158	78	247	124	0.96	25°	4.1
EFOM-10	191	96	450	225	1.84	25°	6.8
EFOM-12	247	124	495	247	1.84	21°	8.9
EFOM-15	292	146	540	270	3.32	20°	15.0
EFOM-16	315	158	629	315	3.32	27°	17.7
EFOM-17	405	202	719	360	3.32	21°	24.9
EFOM-20	405	202	1236	618	7.74	19°	32.8
EFOM-25	674	337	1348	674	7.74	15°	58.5
EFOM-30	687	393	1461	730	15.86	14°	78.9

For another spherical bearing material please add J, R or J4 to the part number; e.g. EFOM-16R

Telephone 1-800-521-2747
Fax 1-401-438-7270

Internet: <http://www.igus.com>
email: sales@igus.com
QuickSpec: <http://www.igus.com/iglide-quickspec>

igubal® Spherical Bearings

Flange Bearing, 4 Hole - Inch - EFSI

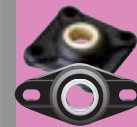

Flange bearing with 4 mounting holes

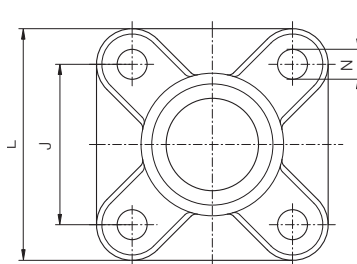

Material:

Housing - igumid G

Ball - iglide® L280

Also available :

iglide® R, iglide® J and iglide® J4

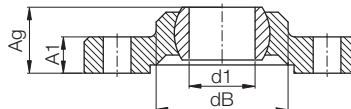

Dimensions (inch)

Part Number	d1 (E10)	dB	L	J Hole Pitch 0.004	A1 Height of Housing	Ag Total Height	N Bore Diameter d x 1
EFSI-03	.1900	.551	.984	.669	.177	.311	.126
EFSI-04	.2500	.551	.984	.669	.177	.343	.126
EFSI-05	.3125	.709	1.299	.866	.217	.413	.169
EFSI-06	.3750	.866	1.496	1.024	.256	.484	.209
EFSI-07	.4375	.984	1.575	1.102	.276	.520	.209
EFSI-08	.5000	.984	1.575	1.102	.276	.520	.209
EFSI-10	.6250	1.260	2.047	1.417	.354	.654	.252
EFSI-12	.7500	1.575	2.559	1.772	.433	.787	.331
EFSI-16	1.000	1.909	2.913	2.047	.551	.965	.331

► Tolerance Table, Page 1.14

Load Data

Part Number	Maximum Static Axial Load		Maximum Static Radial Load		Maximum Static Torque Holes (ft•lbs)	Maximum Pivot angle EFOI	Weight (g)
	Short Term (lbs)	Long Term (lbs)	Short Term (lbs)	Long Term (lbs)			
EFSI-03	50	25	224	112	0.44	33°	2.3
EFSI-04	56	28	224	112	0.96	27°	2.0
EFSI-05	90	45	314	157	1.84	24°	4.0
EFSI-06	112	56	448	224	1.84	24°	6.5
EFSI-07	134	67	562	281	1.84	21°	7.5
EFSI-08	134	67	562	281	3.32	21°	12.0
EFSI-10	282	141	720	360	3.32	24°	17.2
EFSI-12	428	214	900	450	3.32	17°	31.5
EFSI-16	584	292	1258	629	7.74	14°	59.0

For another spherical bearing material please add J, R or J4 to the part number; e.g. EFSI-08R

igubal® Flange

PDF: www.igus.com/iglide-pdfs
 CAD: www.igus.com/iglide-CAD
 RoHS info: www.igus.com/RoHS

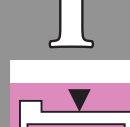



igubal® Spherical Bearings Flange Bearing, 4 Hole - mm - EFSM

igubal® Flange



Flange bearing with
4 mounting holes

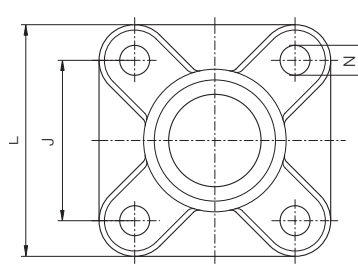

Material:

Housing - igumid G
Ball - iglide® L280
Also available :
iglide® R, iglide® J and iglide® J4

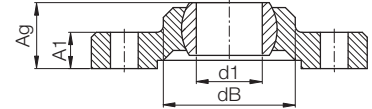

Dimensions (mm)

Part Number	d1 (E10)	dB	L	J Hole Pitch ±0.1mm	A1 Height of Housing	Ag Total Height	N Bore Diameter d x l
EFSM-04	4	14.0	25.0	17.0	4.5	8.5	3.2
EFSM-05	5	14.0	25.0	17.0	4.5	8.5	3.2
EFSM-06	6	14.0	25.0	17.0	4.5	8.5	3.2
EFSM-08	8	18.0	33.0	22.0	5.5	10.5	4.3
EFSM-10	10	22.0	38.0	26.0	6.5	12.0	5.3
EFSM-12	12	25.0	40.0	28.0	7.0	13.0	5.3
EFSM-15	15	30.0	49.0	34.0	8.5	15.5	6.4
EFSM-16	16	32.5	52.0	36.0	9.0	16.5	6.4
EFSM-17	17	35.0	54.0	38.0	10.0	18.0	6.4
EFSM-20	20	40.0	65.0	45.0	11.0	20.0	8.4
EFSM-25	25	48.5	74.0	52.0	14.0	25.0	8.4
EFSM-30	30	55.0	85.0	60.0	15.0	26.0	10.5

► Tolerance Table, Page 1.14

Load Data

Part Number	Maximum Static Axial Load		Maximum Static Radial Load		Maximum Static Torque Holes (ft•lbs)	Maximum Pivot Angle	Weight (g)
	Short Term (lbs)	Long Term (lbs)	Short Term (lbs)	Long Term (lbs)			
EFSM-04	45	22	225	112	0.44	27°	2.0
EFSM-05	67	34	225	12	0.44	24°	4.0
EFSM-06	67	34	225	112	0.44	24°	6.5
EFSM-08	101	51	315	158	0.96	21°	12.0
EFSM-10	158	78	450	225	1.84	24°	17.2
EFSM-12	191	96	562	281	1.84	17°	31.5
EFSM-15	247	124	674	337	3.32	20°	20.2
EFSM-16	304	152	719	360	3.32	14°	59.0
EFSM-17	360	180	764	382	3.32	21°	27.9
EFSM-20	450	225	900	450	7.74	19°	45.0
EFSM-25	540	270	1259	629	7.74	15°	76.0
EFSM-30	629	315	1348	674	15.86	14°	100.7

For another spherical bearing material please add J, R or J4 to the part number; e.g. EFSM-12R

Telephone 1-800-521-2747
Fax 1-401-438-7270

Internet: <http://www.igus.com>
email: sales@igus.com
QuickSpec: <http://www.igus.com/iglide-quickspec>

igubal® Spherical Bearings Flange Bearing - mm - KFSM-GT



Material:
Housing - RN33
Ball - iglide® J

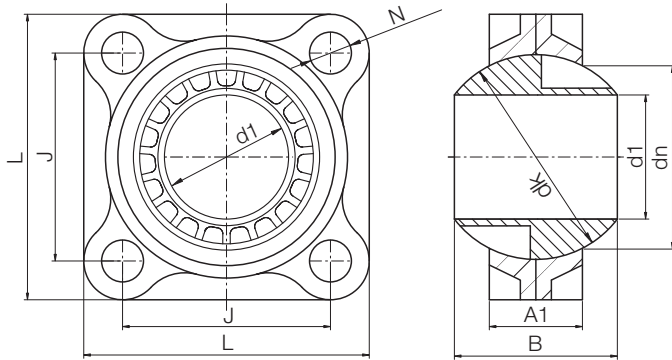

Dimensions (mm)

Part No.	d1 (E10)	dn	d3	dk	A1	A2	B	J	L	N	Max. pivot angle
KFSM-GT35	35.0	59.0	26.0	66.0	30.0	45.0	48.5	66.0	92.0	13.5	24°
KFSM-GT40	40.0	59.0	26.0	66.0	30.0	45.0	48.5	66.0	92.0	13.5	24°
KFSM-GT45	45.0	72.0	26.0	82.0	40.0	60.0	60.0	78.0	104.0	13.5	24°
KFSM-GT50	50.0	72.0	26.0	82.0	40.0	60.0	60.0	78.0	104.0	13.5	24°

► Tolerance Table, Page 1.14

Load Data

Part No.	Maximum static Radial Load		Maximum static Axial Load		Weight (g)
	short term (lbs)	long term (lbs)	short term (lbs)	long term (lbs)	
KFSM-GT35	1125	562	1012	505	183.5
KFSM-GT40	1125	562	1012	505	161.6
KFSM-GT45	1348	674	1125	562	294.6
KFSM-GT50	1348	674	1125	562	260.1

igubal® Flange

PDF: www.igus.com/iglide-pdfs
CAD: www.igus.com/iglide-CAD
RoHS info: www.igus.com/RoHS

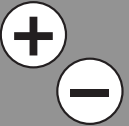



igubal® Spherical Bearings Flange Bearing - mm - EFOM HT

igubal® Flange



Flange bearing with
2 mounting holess

Special Properties

- Temperatures to 392°F
- iglide® T500 highly wear resistant spherical ball

Material:

Housing - iguton G
Ball - iglide® T500

Telephone 1-800-521-2747
Fax 1-401-438-7270

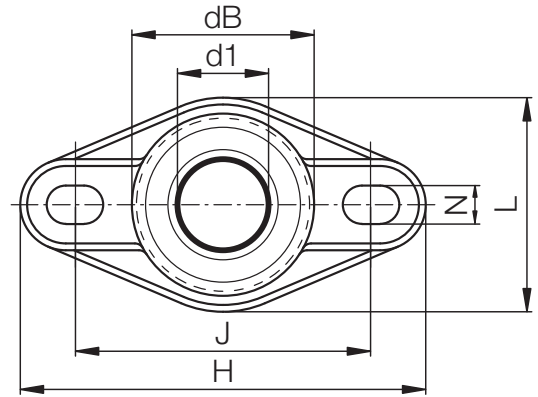
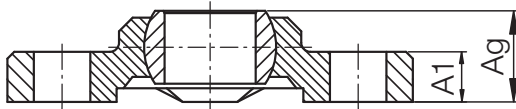

Dimensions (mm)

Part Number	d1 (E10)	dB	H	L	J Hole Pitch	A1 Height of Housing	Ag Total Height	N Bore Diameter d x 1	Maximum Pivot Angle	Weight (g)
EFOM-05-HT	5	14,0	33,8	16,0	24,0	4,5	8,5	3,2 x 5,0	29°	2,5
EFOM-06 HT	6	14,0	33,8	16,0	24,0	4,5	8,5	3,2 x 5,5	27°	2,3
EFOM-08 HT	8	18,0	44,2	22,0	31,0	5,5	10,5	4,3 x 6,5	24°	5,0
EFOM-10 HT	10	22,0	52,0	26,0	36,0	6,5	12,0	5,3 x 8,0	24°	8,3
EFOM-12 HT	12	25,0	56,7	31,0	41,0	7,0	13,0	5,3 x 8,0	21°	10,7

► Tolerance Table, Page 1.14

Internet: <http://www.igus.com>
email: sales@igus.com
QuickSpec: <http://www.igus.com/iglide-quickspec>

igubal® Spherical Bearings Flange Bearing - mm - EFSM HT



Flange bearing with
2 mounting holess

Special Properties

- Temperatures to 392°F
- iglide® T500 highly wear resistant spherical ball

Material:

Housing - iguton G
Ball - iglide® T500

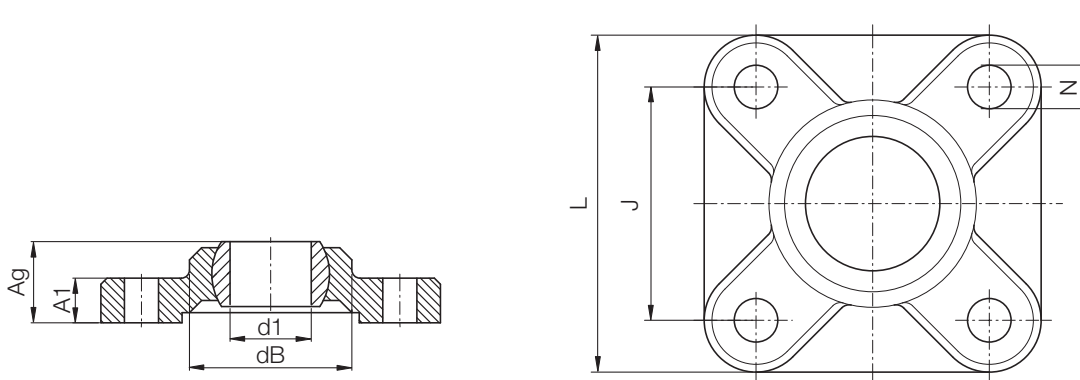

Dimensions (mm)

Part Number	d1 (E10)	dB	L	J Hole Pitch ±0.1	A1 Height of Housing	Ag Total Height	N Bore Diameter d x 1	Maximum Pivot Angle	Weight (g)
EFSM-05-HT	5	14.0	25.0	17.0	4.5	8.5	3.2	29°	3.5
EFSM-06 HT	6	14.0	25.0	17.0	4.5	8.5	3.2	25°	3.3
EFSM-08 HT	8	18.0	33.0	22.0	5.5	10.5	4.3	25°	7.1
EFSM-10 HT	10	22.0	38.0	26.0	6.5	12.0	5.3	25°	11.2
EFSM-12 HT	12	25.0	40.0	28.0	7.0	13.0	5.3	21°	13.3

► Tolerance Table, Page 1.14

igubal® Flange

PDF: www.igus.com/iglide-pdfs
CAD: www.igus.com/iglide-CAD
RoHS info: www.igus.com/RoHS





igubal® Spherical Bearings Flange Bearing

igubal® Flange

Telephone 1-800-521-2747
Fax 1-401-438-7270

Internet: <http://www.igus.com>
email: sales@igus.com
QuickSpec: <http://www.igus.com/iglide-quickspec>



**igubal[®] Pressfit, Clip,
Double Joint & Thrust**



**igubal® Spherical Bearings
Pressfit Bearings**



KGLI - inch
Page 39.5

KGLM - metric
Page 39.6

K Series



EGFM-T - metric

Page 39.13

E Series



EGLM - metric

Page 39.7



ECLM-HD - metric

Page 39.14



KGLI-SL - inch
Page 39.8

KGLM-SL - inch
Page 39.9



EGZM - metric

Page 39.15



KGLM-LC - metric

Page 39.10



KDGM - metric

Page 39.16



ECLM - metric

Page 39.12



WDGM - metric

Page 39.17



Typical industries and applications

- Food industry
- Railway technology
- Automotive
- Industrial, etc.

Ease of installation makes diverse applications possible for igubal® spherical bearings. They can be used anywhere. The self-aligning feature offers design advantages and helps to simplify assembly.



Food industry



Carriage in a crane system



Automotive industry



Hose skiving



Product Range

- Standard Styles:
Dimensional Series E
Dimensional Series K
- Pitch 25-200 mm
- For shaft diameters:
Inch sizes from 3/16 - 1 in.
Metric sizes from 2 - 30 mm

Part Number Structure

Part Number Structure

K GL M - 08 - 02

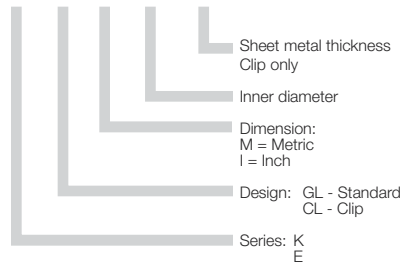

Usage Guidelines



- If chemical resistance is required
- When shaft misalignment needs to be resolved
- If easy assembly is requested
- If dirt/dust resistant bearings are necessary
- In applications where lubrication could present and issue
- When high axial and radial loads exist
- When reduction of installation space is important
- If a cost-effective option is requested



- If temperatures are higher than +194°F
- If rotation speeds are above 100 fpm
- If dimensions above 1" or 30mm are necessary



igubal® Pivoting Bearings

The use of pivoting bearings is usually associated with heavier traditional metal bearings, difficult installation, and high costs. Most of the time, maintenance is still necessary over the long term, and the bearings are only corrosion-resistant in special designs. Often roller bearings or plain bearings malfunction prematurely due to high edge loads, or bearings must be readjusted, reamed, or retrofit in order to compensate for alignment errors.

igubal® pivoting bearings put an end to all of these disadvantages and open up many new possibilities for your engineering design.

Area of Application

Ease of installation makes diverse applications possible for igubal® pivoting bearings. They can be used anywhere the self-adjusting feature offers design advantages or helps to simplify assembly.

Tolerances

Maintenance-free igubal® pivoting bearings are meant to be oversized before being pressfit. After proper installation into a recommended housing bore, the inner diameter adjusts to meet our specified tolerances. Please adhere to the catalog specifications for housing bore and recommended shaft sizes. This will help to ensure optimal performance of iglide plain bearings. Please contact an iglide® technical expert for support.

► Tolerance Table, Page 1.14

Installation

igubal® pivoting bearings are pressfit into a recommended housing bore and axially secured. An exact orientation of the bearing housing is not necessary, since the pivoting bearing compensates for alignment errors.

Dimensions

igubal® spherical bearings are manufactured according to DIN ISO 12240 dimensional series K and E. The product range provides dimensions from 0.19 to 1.0" and 2 to 30mm. Please contact us if you need other dimensions.

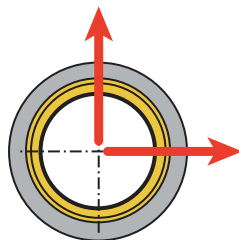

Compressive Strength
Radial

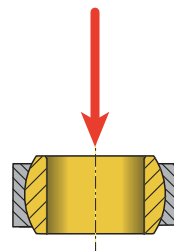

Compressive Strength
Axial

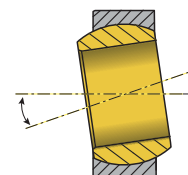

Pivot Angle

igubal® Spherical Bearings Pressfit Bearings - inch - KGLI

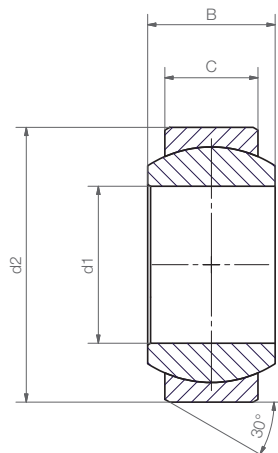

Material:
Housing - igumid G
Ball - iglide® L280

igubal®
Pivoting Bearings

Dimensions (inch)

Part No.	d1 (E10)	d2 Inch	B Inch	C Inch	Max. pivot angle	Weight (g)
KGLI-03	.1900	.5625	.312	.218	34°	1.2
KGLI-04	.2500	.6562	.375	.250	30°	1.7
KGLI-05	.3125	.7500	.437	.281	29°	2.6
KGLI-06	.3750	.8125	.500	.312	25°	3.3
KGLI-07	.4375	.9375	.562	.343	25°	4.9
KGLI-08	.5000	1.0625	.625	.390	25°	7.1
KGLI-10	.6250	1.1875	.750	.500	23°	10.2
KGLI-12	.7500	1.4375	.875	.593	23°	17.5
KGLI-16	1.0000	2.1250	1.375	1.005	23°	62.0

PDF: www.igus.com/iglide-pdfs
CAD: www.igus.com/iglide-CAD
RoHS info: www.igus.com/RoHS

Technical Data

Part No.	Maximum Static Compressive Strength		Maximum Torque for the assembly (ft lbs)	Housing Bore		Shaft Size	
	radial (lbs)	axial (lbs)		Min	Max.	Min.	Max.
KGLI-03	225	34	3.69	.5625	.5630	.1888	.1900
KGLI-04	337	56	7.37	.6562	.6568	.2485	.2500
KGLI-05	450	79	8.85	.7500	.7509	.3110	.3125
KGLI-06	629	90	14.75	.8125	.8134	.3735	.3750
KGLI-07	843	101	22.13	.9375	.9382	.4358	.4375
KGLI-08	955	112	25.82	1.0625	1.0632	.4983	.5000
KGLI-10	1191	169	29.50	1.1875	1.1882	.6233	.6250
KGLI-12	1911	191	40.57	1.4375	1.4383	.7479	.7500
KGLI-16	3057	562	47.94	2.1250	2.1258	.9988	1.0000

► Tolerance Table, Page 1.14
For housing bores (H7)
For shaft sizes (h7)

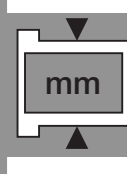
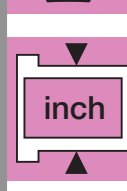
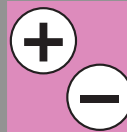



igubal® Spherical Bearings Pressfit Spherical Bearings KGLM - mm

igubal®
Pivoting Bearings

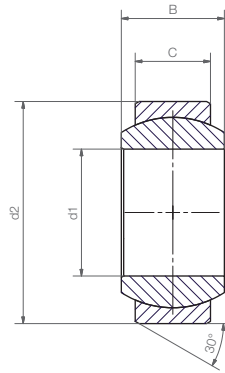

Material:
Housing - igumid G
Ball - iglide® L280

Dimensions (mm)

Part No.	d1 (E10) (mm)	d2 (mm)	B (mm)	C (mm)	Max. pivot angle	Weight (g)
KGLM-02	2	8	4	3.0	32°	0.1
KGLM-03	3	10	6	4.5	32°	0.5
KGLM-05	5	13	8	6.0	30°	1.0
KGLM-06	6	16	9	6.5	29°	1.6
KGLM-08	8	19	12	9.0	25°	2.9
KGLM-10	10	22	14	10.5	25°	4.4
KGLM-12	12	26	16	12.0	25°	7.0
KGLM-14	14	28	19	13.5	23°	9.1
KGLM-16	16	32	21	15.0	23°	12.8
KGLM-18	18	35	23	16.5	23°	16.6
KGLM-20	20	40	25	18.0	23°	24.4
KGLM-22	22	42	28	20.0	22°	28.5
KGLM-25	25	47	31	22.0	22°	39.3
KGLM-30	30	55	37	25.0	22°	62.6

Load Data

Part No.	Maximum Static Compressive Strength		Maximum Torque through the ball (ft lbs)	Housing Bore		Shaft Size	
	radial (lbs)	axial (lbs)		Min.	Max.	Min.	Max.
KGLM-02	67	13	0.7	8.0000	8.0150	1.9900	2.0000
KGLM-03	119	34	2.2	10.0000	10.0150	2.9900	3.0000
KGLM-05	281	56	3.7	13.0000	13.0180	4.9800	5.0000
KGLM-06	393	90	7.4	16.0000	16.0180	5.9800	6.0000
KGLM-08	528	180	8.9	19.0000	19.0210	7.9850	8.0000
KGLM-10	798	202	14.8	22.0000	22.0210	9.9850	10.0000
KGLM-12	944	214	22.1	26.0000	26.0210	11.9820	12.0000
KGLM-14	1281	270	25.8	28.0000	28.0250	13.9820	14.0000
KGLM-16	1686	292	29.5	32.0000	32.0250	15.9820	16.0000
KGLM-18	1910	315	33.2	35.0000	35.0250	17.9820	18.0000
KGLM-20	2203	427	40.6	40.0000	40.0250	19.9790	20.0000
KGLM-22	2630	584	44.3	42.0000	42.0250	21.9790	22.0000
KGLM-25	3057	674	47.9	47.0000	47.0250	24.9790	25.0000
KGLM-30	4496	731	51.6	55.0000	55.0300	29.9790	30.0000

► Tolerance Table, Page 1.14
For housing bores (H7)
For shaft sizes (h7)

Telephone 1-800-521-2747
Fax 1-401-438-7270

Internet: <http://www.igus.com>
email: sales@igus.com
QuickSpec: <http://www.igus.com/iglide-quickspec>

igubal® Spherical Bearings Pressfit Bearings - mm - EGLM

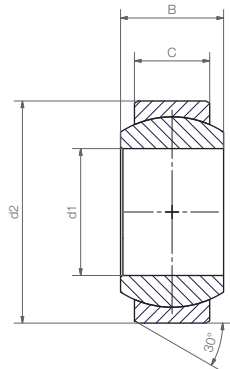

Material:
Housing - igumid G
Ball - iglide® L280

igubal®
Pivoting Bearings

Dimensions (mm)

Part No.	d1 (E10) (mm)	d2 (mm)	B (mm)	C (mm)	Max. pivot angle	Weight (g)
EGLM-04	4	12	5	3.0	37°	0.4
EGLM-05	5	14	6	4.0	33°	0.8
EGLM-06	6	14	6	4.0	27°	0.9
EGLM-08	8	16	8	5.0	24°	1.2
EGLM-10	10	19	9	6.0	24°	1.9
EGLM-12	12	22	10	7.0	21°	2.8
EGLM-15	15	26	12	9.0	21°	6.9
EGLM-16	16	28	13	9.5	21°	9.0
EGLM-17	17	30	14	10.0	21°	10.6
EGLM-20	20	35	16	12.0	18°	16.3
EGLM-25	25	42	20	16.0	16°	29.0
EGLM-30	30	47	22	18.0	13°	37.4

PDF: www.igus.com/iglide-pdfs
CAD: www.igus.com/iglide-CAD
RoHS info: www.igus.com/RoHS

Load Data

Part No.	Maximum Static Compressive Strength		Maximum Torque through the ball (ft lbs)	Housing Bore		Shaft Size	
	radial (lbs)	axial* (lbs)		Min	Max.	Min.	Max.
EGLM-04	135	11	1.5	12.0000	12.0180	3.9800	4.0000
EGLM-05	213	22	1.5	14.0000	14.0180	4.9800	5.0000
EGLM-06	236	28	1.8	14.0000	14.0180	5.9800	6.0000
EGLM-08	303	39	5.2	16.0000	16.0180	7.9850	8.0000
EGLM-10	449	67	10.3	19.0000	19.0210	9.9850	10.0000
EGLM-12	505	101	18.4	22.0000	22.0210	11.9820	12.0000
EGLM-15	775	112	22.1	26.0000	26.0210	14.9820	15.0000
EGLM-16	876	135	23.6	28.0000	28.0210	15.9820	16.0000
EGLM-17	921	157	25.8	30.0000	30.0250	16.9820	17.0000
EGLM-20	1202	269	29.5	35.0000	35.0250	19.9790	20.0000
EGLM-25	1843	393	40.6	42.0000	42.0250	24.9790	25.0000
EGLM-30	2472	562	51.6	47.0000	47.0250	29.9790	30.0000

*Maximum static axial load is determined in a remote location hole.

► Tolerance Table, Page 1.14

For housing bores (H7)

For shaft sizes (h7)

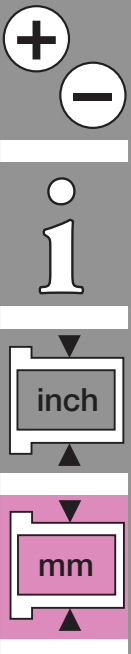



igubal® Spherical Bearings Pressfit Bearings KGLI SL, Slimline - inch

igubal®
Pivoting Bearings

Telephone 1-800-521-2747
Fax 1-401-438-7270

Internet: <http://www.igus.com>
email: sales@igus.com
QuickSpec: <http://www.igus.com/iglide-quickspec>



Special Properties

- 50% thinner than standard KGLM

Material:

Housing - igumid G
Ball - iglide® R

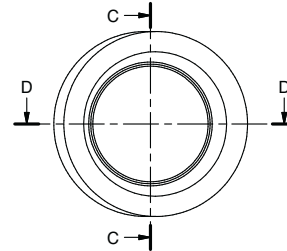
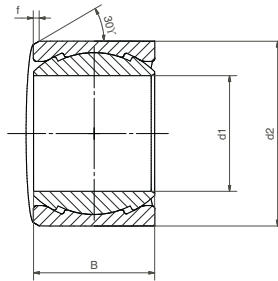
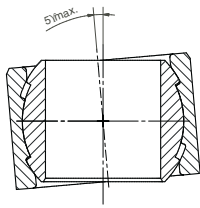

Dimensions (inch)

Part Number	d1 (E10)	d2	B	f	Max. pivot angle	Weight (g)
KGLI-03 SL	0.1900	0.3750	0.1875	0.0200	5°	0.69
KGLI-04 SL	0.2500	0.5000	0.2500	0.0200	5°	0.75
KGLI-05 SL	0.3125	0.5000	0.3125	0.0200	5°	1.0
KGLI-06 SL	0.3750	0.6250	0.3750	0.0200	5°	1.3
KGLI-08 SL	0.5000	0.8125	0.5000	0.2000	5°	2.5

Load Data

Part Number	Max. radial compressive strength		Max. axial compressive strength		Housing Bore		Shaft Size	
	Short term (lbs)	Long term (lbs)	Short term (lbs)	Long term (lbs)	Min.	Max.	Min.	Max.
KGLI-03 SL	225	112	34	17	0.3750	0.3756	0.1888	0.1900
KGLI-04 SL	337	168	56	28	0.5000	0.5007	0.2485	0.2500
KGLI-05 SL	450	225	79	39	0.5000	0.5007	0.3110	0.3125
KGLI-06 SL	630	315	112	56	0.6250	0.6257	0.3735	0.3750
KGLI-08 SL	955	478	135	67	0.8125	0.8133	0.4983	0.5000

igubal® Spherical Bearings

Pressfit Bearings

KGLM SL, Slimline - mm



Special Properties

- 50% thinner than standard KGLM

Material:

Housing - igumid G
Ball - iglide® L280

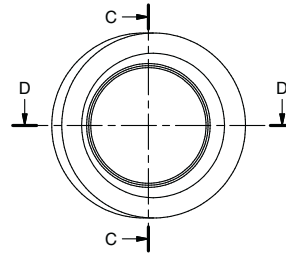
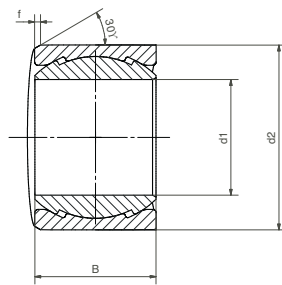
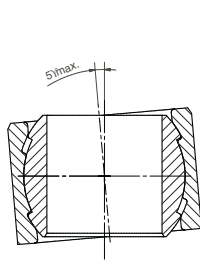

Dimensions (mm)

Part Number	d1 (E10) (mm)	d2 (mm)	B (mm)	f (mm)	Max. Pivot Angle	Weight (g)
KGLM-08 SL	8	14	9.0	0.5	5°	1.1
KGLM-10 SL	10	16	10.5	0.5	5°	1.5
KGLM-12 SL	12	18	12.0	0.5	5°	2.0
KGLM-16 SL	16	22	15.0	0.5	5°	3.1

Load Data

Part Number	Max. radial compressive strength		Max. axial compressive strength		Housing Bore		Shaft Size	
	Short term (lbs)	Long term (lbs)	Short term (lbs)	Long term (lbs)	Min.	Max.	Min.	Max.
KGLM-08 SL	607	304	101	51	14.0000	14.0180	7.9850	8.0000
KGLM-10 SL	899	450	169	84	16.0000	16.0180	9.9850	10.0000
KGLM-12 SL	1012	506	169	84	18.0000	18.0180	11.9820	12.0000
KGLM-16 SL	1461	731	112	56	22.0000	22.0210	15.9820	16.0000

igubal®
Pivoting Bearings

PDF: www.igus.com/iglide-pdfs
CAD: www.igus.com/iglide-CAD
RoHS info: www.igus.com/RoHS

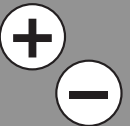



igubal® Spherical Bearings Pressfit Bearings KGLM LC, Split Housing - mm

igubal®
Pivoting Bearings

Telephone 1-800-521-2747
Fax 1-401-438-7270

Internet: <http://www.igus.com>
email: sales@igus.com
QuickSpec: <http://www.igus.com/iglide-quickspec>

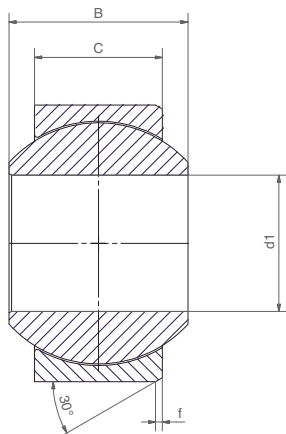
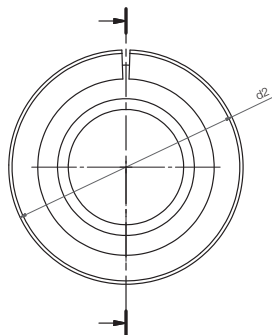

Special Properties

- Easy to install
- Split housing

Material:

Housing - igumid G

Ball - iglide® L280

Also available: iglide® R, iglide® J, iglide® J4

Dimensions (mm)

Part Number	d1 (E10) (mm)	d2 (mm)	B (mm)	C (mm)	f (mm)	Max. pivot angle	Weight (g)
KGLM-10 LC	10	22.0	14	10.5	0.8	25°	4.3
KGLM-12 LC	12	26.0	16	12	0.8	25°	6.9
KGLM-16 LC	16	32.0	21	15	0.8	23°	12.7
KGLM-20 LC	20	40.0	25	18	0.8	23°	23.6
KGLM-25 LC	25	47.0	31	22	0.8	22°	38.9
KGLM-30 LC	30	55.0	37	25	1.0	22°	61.0

Load Data

Part Number	Max. radial compressive strength		Max. axial compressive strength	
	Short term (lbs)	Long term (lbs)	Short term (lbs)	Long term (lbs)
KGLM-10 LC	899	450	315	157
KGLM-12 LC	1214	607	337	169
KGLM-16 LC	1798	899	674	337
KGLM-20 LC	2248	1124	1124	562
KGLM-25 LC	3057	1529	1686	843
KGLM-30 LC	4496	2248	2023	1012

igubal® Spherical Bearings
 Pressfit Bearings
 KGLM H, Split Housing - mm



Special Properties

- Quiet operation
- Low tolerances
- Easy to install
- Meant for joystick applications
- Compensation of misalignment error, precise run

Material:

Housing - igumid G
 Ball - iglide® L250

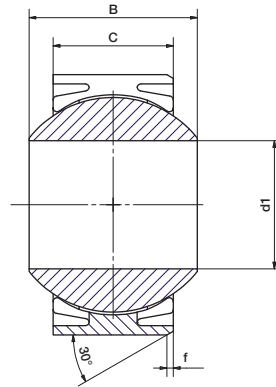
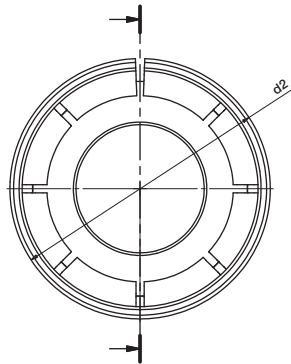

Dimensions (mm)

Part Number	d1	d2	B	C	f	Max. pivot angle	Weight
	(E10) (mm)	(mm)	(mm)	(mm)	(mm)		
KGLM-16 H	16	32.0	21	15	0.8	22°	12.2

Load Data

Part Number	Max. radial compressive strength		Max. axial compressive strength	
	Short term (lbs)	Long term (lbs)	Short term (lbs)	Long term (lbs)
KGLM-16 H	900	450	67	34

igubal®
 Pivoting Bearings

PDF: www.igus.com/iglide-pdfs
 CAD: www.igus.com/iglide-CAD
 RoHS info: www.igus.com/RoHS

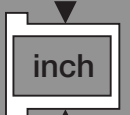
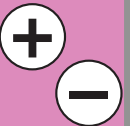



igubal® Spherical Bearings Self-aligning Clip Bearings - mm - ECLM

igubal®
Pivoting Bearings

Telephone 1-800-521-2747
Fax 1-401-438-7270

Internet: <http://www.igus.com>
email: sales@igus.com
QuickSpec: <http://www.igus.com/iglide-quickspec>

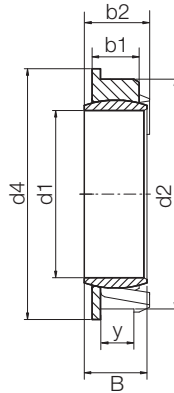
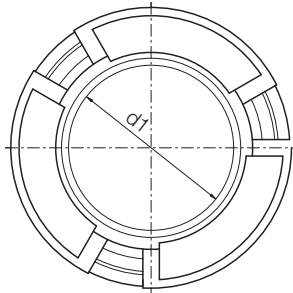

Special Properties

- Extremely easy installation - just clip into sheet metal
- No additional axial retainer required
- Extremely low installation space
- Maintenance-free iglide® spherical balls

Material:

Housing - igumid G
Ball - iglide® J

Dimensions (mm)

Part No.	d1	B	d2	d4	y	b1	b2	Max. Pivot angle
	(E10)	(mm)	(mm)	(mm)	(mm)	(mm)	(mm)	(mm)
ECLM-05-02	5	9	12	13	2.0	3.9	6.0	25°
ECLM-06-02	6	9	12	13	2.0	3.9	6.0	18°
ECLM-08-02	8	10.5	14	15	2.0	3.9	6.0	16°
ECLM-10-03	10	12.4	16	17	3.0	4.5	6.7	12°
ECLM-12-03	12	14.2	18	19	3.0	4.5	6.7	12°
ECLM-16-03	16	18.2	22	24	3.0	4.5	6.7	12°

Load Data

Part Number	Max. radial compressive strength		Max. axial compressive strength		Weight (g)
	Short term (lbs)	Long term (lbs)	Short term (lbs)	Long term (lbs)	
ECLM-05-02	157	79	6	3	0.5
ECLM-06-02	157	79	6	3	0.5
ECLM-08-02	225	112	6	3	0.5
ECLM-10-03	315	157	7	2	0.8
ECLM-12-03	405	202	8	2	0.8
ECLM-16-03	629	315	10	5	1.1

igubal® Spherical Bearings Self-aligning Clip Bearings EGFM T, Heavy Duty - mm

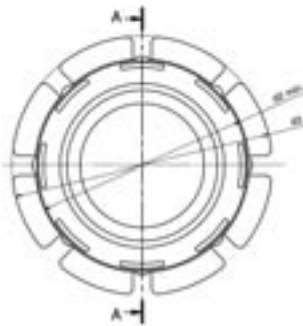

Special Properties

- Maintenance-free, dry-running
- Easy to fit
- Can compensate for a housing tolerance of ± 0.2 mm

Material:

Housing - igumid G
Ball - iglide® L280
Also available: iglide® R,
iglide® J, iglide® J4

Dimensions (mm)

Part No.	d1 (E10) (mm)	d2		d3 (mm)	C (mm)	B (mm)	b2 (mm)	Max. pivot angle	Weight (g)
		min. (mm)	max. (mm)						
EGFM-08 T SL*	8 (H10)	15.8	16.5	18	5.0	6	1.1	11°	0.9
EGFM-10 T	10	20.8	21.6	26	6.0	9	1.0	24°	2.4
EGFM-12 T	12	22.8	23.6	28	7.0	10	1.0	21°	3.0
EGFM-16 T	16	29.8	30.6	35	9.5	13	1.5	21°	6.6
EGFM-20 T	20	34.8	35.6	42	12.0	16	2.0	18°	11.1
EGFM-25 T	25	41.8	42.6	50	16.0	20	2.0	16°	19.0
EGFM-30 T	30	46.8	47.6	55	18.0	22	2.0	13°	24.0

Load data

Part Number	Max. radial compressive strength		Max. axial compressive strength		Housing	
	Short term (lbs)	Long term (lbs)	Short term (lbs)	Long term (lbs)	Min.	Max.
EGFM-08 T SL*	250	124	34	17	15.8	16.2
EGFM-10 T	427	214	50	25	20.8	21.2
EGFM-12 T	560	280	61	30	22.8	23.2
EGFM-16 T	1350	675	135	67	29.8	30.2
EGFM-20 T	2020	1012	180	90	34.8	35.2
EGFM-25 T	3147	1574	630	315	41.8	42.2
EGFM-30 T	3822	1910	675	337	46.8	47.2

*Spherical ball made from iglide® J

igubal®
Pivoting Bearings

PDF: www.igus.com/iglide-pdfs
CAD: www.igus.com/iglide-CAD
RoHS info: www.igus.com/RoHS





igubal® Spherical Bearings Self-aligning Clip Bearings - mm - ECLM HD Heavy Duty

igubal®
Pivoting Bearings

Telephone 1-800-521-2747
Fax 1-401-438-7270

Internet: <http://www.igus.com>
email: sales@igus.com
QuickSpec: <http://www.igus.com/iglide-quickspec>



Special Properties

- High axial and radial loads
- Easily clips into sheet metal
- No additional axial fastening necessary
- Extremely compact design and installation
- Adjustment of axial and radial clearance by pre-loading
- Maintenance-free iglide® spherical balls
- For sheet thickness 5 mm

Material:

Housing - igumid G
Ball - iglide® L280
Also available: iglide® R,
iglide® J, iglide® J4

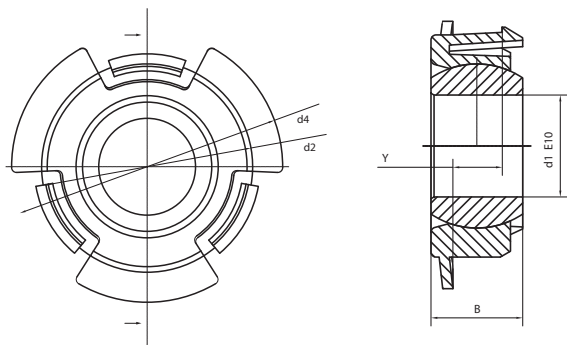

Dimensions [mm]

Part No.	d1 (E10) (mm)	B (mm)	d2 ±0.15 (mm)	d4 (mm)	Y ±0.1 (mm)	Max. pivot angle
ECLM-10-05 HD	10.0	9.0	22.0	28	5.0	24°

Load Data

Part Number	Max. radial compressive strength		Max. axial compressive strength		Weight (g)
	Short term (lbs)	Long term (lbs)	Short term (lbs)	Long term (lbs)	
ECLM-10-05 HD	560	280	34	17	3.1

igubal® Spherical Bearings Pivoting Bearings - mm - EGZM Double Joint



Special Properties

- Mechanical joining link between 2 components
- Special lengths often possible, please contact igus®

Material:

Housing - igumid G
Ball - iglide® L280
Also available: iglide® R, iglide® J, iglide® J4

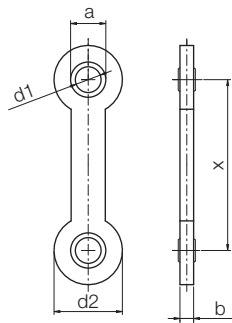

Part Number Structure

For igubal® Double Joint Bearings

E GZ M - 05 - 50



Dimensions [mm] and Load Data

Part No.	d1 (E10) (mm)	d2 (mm)	x (mm)	b (mm)	a (mm)	Maximum radial static tensile strength		Maximum axial static tensile strength		Weight (g)
						Short term	Long term	Short term	Long term	
						(lbs)	(lbs)	(lbs)	(lbs)	
EGZM-04-25	04	20	25	4	10	247	124	292	146	3.5
EGZM-04-50	04	20	50	4	10	247	124	169	84	4.8
EGZM-04-75	04	20	75	4	10	247	124	112	56	6.1
EGZM-05-25	05	20	25	4	10	247	124	292	146	2.2
EGZM-05-50	05	20	50	4	10	247	124	169	84	4.9
EGZM-05-75	05	20	75	4	10	247	124	112	56	6.3
EGZM-06-25	06	20	25	4	10	247	124	292	146	3.4
EGZM-06-50	06	20	50	4	10	247	124	169	84	4.8
EGZM-06-75	06	20	75	4	10	247	124	112	56	3.4
EGZM-08-60	08	30	60	7	15	674	337	787	393	15.2
EGZM-08-100	08	30	100	7	15	674	337	427	214	19.5
EGZM-10-60	10	30	60	7	15	562	281	787	393	15.3
EGZM-10-85	10	30	85	7	15	562	281	517	259	18.1
EGZM-10-100	10	30	100	7	15	562	281	427	214	19.4
EGZM-12-60	12	30	60	7	15	450	225	787	393	14.7
EGZM-12-100	12	30	100	7	15	450	225	427	214	18.8

► Tolerance Table, Page 1.14

igubal®
Pivoting Bearings

PDF: www.igus.com/iglide-pdfs
CAD: www.igus.com/iglide-CAD
RoHS info: www.igus.com/RoHS

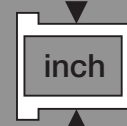
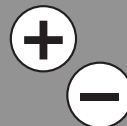



igubal® Spherical Bearings Pivoting Bearings - mm - KDGM Variable Double Joint

igubal®
Pivoting Bearings

Telephone 1-800-521-2747
Fax 1-401-438-7270

Internet: <http://www.igus.com>
email: sales@igus.com
QuickSpec: <http://www.igus.com/iglide-quickspec>



A-Version



B-Version

Special Properties

- Individual center dimensions
- Individual alignment of the bearing position

Material:

Housing - igumid G
Ball - iglide® L280, iglide® R,
iglide® J, iglide® J4, EK

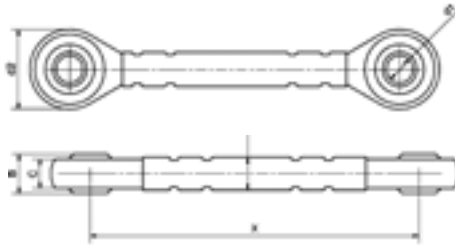

Part Number Structure

For igubal® Double Joint Bearings

K DG M - 06 - 75

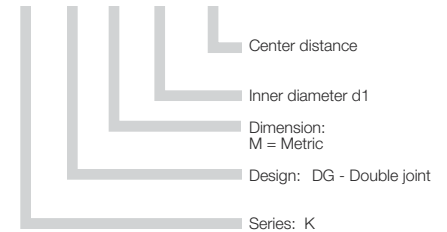

Dimensions (mm)

Part No.	d1 (E10) (mm)	d2 (mm)	d3 (mm)	X (min.) (mm)	B (mm)	C (mm)	Max. pivot angle
KDGM-06-XX-X	6.0	20.0	6.0	50.0	9.0	7.0	40°
KDGM-08-XX-X	8.0	24.0	8.0	65.0	12.0	9.0	35°
KDGM-10-XX-X	10.0	30.0	10.0	80.0	14.0	10.5	35°
KDGM-12-XX-X	12.0	34.0	12.0	90.0	16.0	12.0	35°

Please complete the Part No. with the desired center distance in mm and the alignment of the bearing position.
Order example: KDGM-05-100-A, center distance 100 mm, ball in the same alignment.

igubal® Spherical Bearings Pivoting Bearings - mm - WDM Variable Double Joint with Socket Cup



A-Version



B-Version



C-Version



Special Properties

- Individual center dimensions
- Individual alignment of the bearing position

Material:

Housing - igumid G
Ball stud - igumid G, steel

Part Number Structure

For igubal® Double Joint Bearings

W DG M - 06 - 75

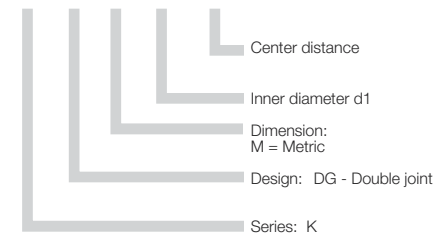

Dimensions (mm)

Part No.	d1 (mm)	d2 (mm)	d3 (mm)	X (min.) (mm)	B (mm)	h1 (mm)	h2 (mm)	Max. pivot angle
WDGM-05-XX-X	M5	12.8	8.0	45.0	10.8	4.6	19.2	23°
WDGM-06-XX-X	M6	14.8	10.0	50.0	12.3	6.1	23.5	25°
WDGM-08-XX-X	M8	19.3	12.0	60.0	16.2	5.9	29.5	24°
WDGM-10-XX-X	M10	24.0	14.0	70.0	20.0	7.9	36.0	25°

Please complete the Part No. with the desired center distance in mm and the alignment of the bearing position.

Order example: WDGM-05-100-A, center distance 100 mm, ball stud in the same alignment.

igubal®
Pivoting Bearings

PDF: www.igus.com/iglide-pdfs
CAD: www.igus.com/iglide-CAD
RoHS info: www.igus.com/RoHS





igubal® Spherical Bearings Pivoting Bearings - mm - EGXM Double Joint

igubal®
Pivoting Bearings

Telephone 1-800-521-2747
Fax 1-401-438-7270

Internet: <http://www.igus.com>
email: sales@igus.com
QuickSpec: <http://www.igus.com/iglide-quickspec>



Special Properties

- Double joint 90° turned
- Easy assembling
- Custom designed with and without ball stud
- Maintenance-free cap made out of iglide® L280

More sizes upon request

Material:

Housing - igumid G
Ball - iglide® L280, iglide® R, iglide® J

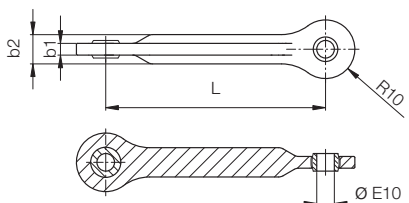

Part Number Structure

For igubal® Double Joint Bearings

E GX M - 06 - 75

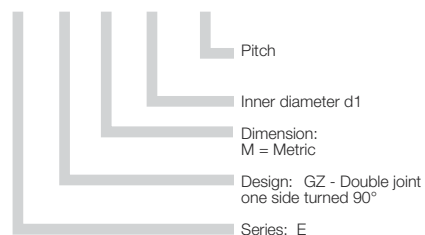

Load Data and Dimensions (mm)

Part No.	Maximum permitted tensile force		Maximum permitted compressive force		Ø Spherical ball d	Center distance L	Head thickness b1	Housing size b2
	Short term (lbs)	Long term (lbs)	Short term (lbs)	Long term (lbs)				
EGXM-06-75	247	124	360	180	6	75	4	10

More combinations Available:

EGXM-06-75 ZM (with metal ball stud)

EGXM-06-75 ZK (with stainless steel ball)

EGXM-06-75 EK (with plastic ball stud)

igubal® Spherical Bearings
Spherical Thrust Bearing
SAM - mm



Material:
Housing - igumid G
Ball stud - iglide® L280



igubal®
Pivoting Bearings

Spherical Washer

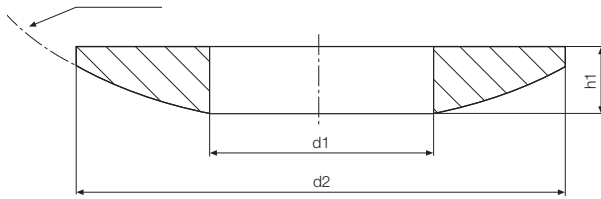

Housing

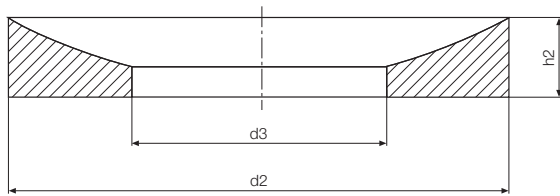

Part Number Structure

SA M - 05



PDF: www.igus.com/iglide-pdfs
CAD: www.igus.com/iglide-CAD
RoHS info: www.igus.com/RoHS

Dimensions (mm)

Part No.	d1 Housing DIN 7168	d3 Spherical Washer DIN 7168	d2	h1 Housing	h2 Spherical Washer	H Total Height	R1 Radius	Compensation angle
SAM-05	7.0	5.2	15.0	3.0	3.5	4.7	15.0	3°
SAM-06	7.5	6.2	16.0	3.0	4.0	5.7	16.0	3°
SAM-08	10.0	8.2	20.0	4.0	5.0	6.4	20.0	2°
SAM-10	12.0	10.2	24.0	4.5	5.5	7.3	24.0	2°
SAM-12	14.5	12.2	30.0	5.0	6.0	7.9	32.0	2°
SAM-16	19.0	16.5	36.0	5.5	6.5	8.5	40.0	2°
SAM-20	23.0	20.2	44.0	6.0	7.0	8.4	45.0	2°

Load Data

Part No.	Maximum Static Axial Tensile Strength		Weight (g)
	Short-term (lbs)	Long-term (lbs)	
SAM-05	900	450	0.9
SAM-06	1124	562	1.1
SAM-08	1798	899	2.2
SAM-10	2248	1124	3.4
SAM-12	2698	1349	5.9
SAM-16	3821	1910	8.5
SAM-20	4946	2473	12.8

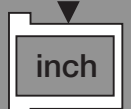
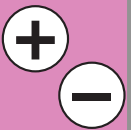



igubal® Spherical Bearings
Pivoting Bearings

igubal®
Pivoting Bearings

Telephone 1-800-521-2747
Fax 1-401-438-7270

Internet: <http://www.igus.com>
email: sales@igus.com
QuickSpec: <http://www.igus.com/iglide-quickspec>



igubal[®]

Spherical Balls



Available Materials & Features

Available Styles



K Series

E Series

iglide[®] L280 (standard)

- extreme wear resistance

WKM/WKI - metric/inch
WEM/WEI - metric/inch

Page 40.5



K Series

E Series

iglide[®] R

- low cost
- low friction values

REI - inch
REM/RKM - metric

Page 40.6



K Series

E Series

iglide[®] T500

- for high temperatures
- resistant to chemicals

TKM - metric
TEM - metric

Page 40.6



K Series

E Series

iglide[®] J

- low friction values
- low moisture absorption

JKM - metric
JEM - metric

Page 40.7



E Series

iglide[®] UW

- for underwater applications

UWEM - metric

Page 40.7



E Series

iglide[®] JV

- pretensioned

J4VEM - metric

Page 40.8

igubal® Spherical Bearings Spherical Balls Application Examples



Typical industries and applications

- Plant construction
- Model building
- Furniture/Industrial design etc.



Drum bearing in a tumble dryer



igubal® spherical balls in the food industry



Carriage in a crane system



igubal used in an office chair



igubal® Spherical Bearings Spherical Balls

Product Range

- Inner diameters:
Inch sizes from 3/16 to 1"
Metric sizes from 2 - 30 mm
- 6 different materials available

Part Number Structure

Part Number Structure

W E M - 12 - 10

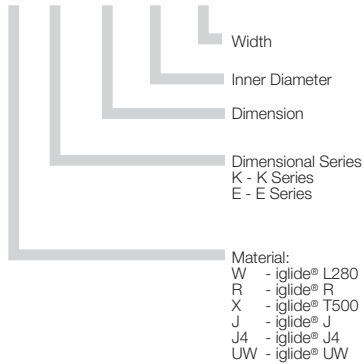

Each iglide® material has its own special properties, which determines the suitability for your special application and requirements.

igubal® spherical bearings are available made from iglide® materials L280 (standard), R, T500, J, J4, and UW. The maintenance-free igubal® spherical bearings have an inside diameter tolerance of E10. The shaft should fall within a tolerance range of h6 to h9. See page 1.14 for details.



Advantages



- If maintenance-free material is requested
- If different iglide® materials should be tested
- If high compressive strength is required
- If high elasticity is required



- If temperatures are higher than 492°F
- If dimensions above 1" or 30 mm are necessary
- If rotation speeds higher than 100 fpm are required
- When a plain bearing is required (See iglide® plain bearing section)

Housing Bore Recommendations

INCH

Nominal Size	Min.	Max.
1/4	0.5000	0.5007
3/8	0.6250	0.6257
1/2	0.8750	0.8758
5/8	1.1250	1.1258
3/4	1.2500	1.2510
1	1.5625	1.5630
1-1/4	2.0000	2.0010
1-1/2	2.3750	2.3760
2	3.0000	3.0010

Housing Bore Recommendations

METRIC

Nominal Size	Min.	Max.
8	16.000	16.018
10	19.000	19.021
12	22.000	22.021
16	26.000	26.021
20	32.000	32.025
25	40.000	40.025
30	47.000	47.025
40	62.000	62.030
50	75.000	75.030



Standard – iglide® L280; extreme wear resistance

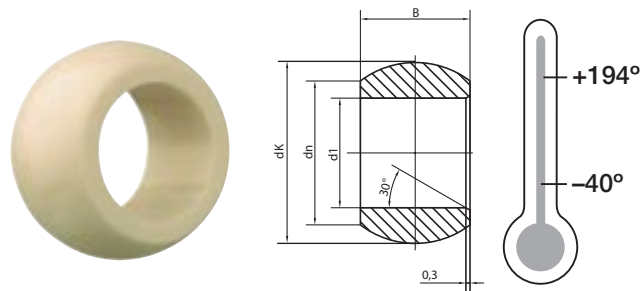
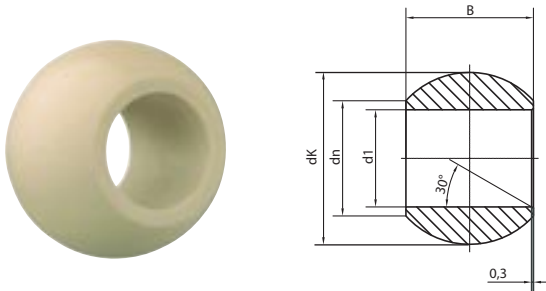

Dimensions (inch)
igubal® Spherical Balls WKI

Part No.	d1 E10	dn	dK	B
WKI-03	.1900	.307	.438	.312
WKI-04	.2500	.354	.516	.375
WKI-05	.3125	.447	.625	.437
WKI-06	.3750	.504	.718	.500
WKI-07	.4375	.601	.828	.562
WKI-08	.5000	.700	.938	.625
WKI-10	.6250	.838	1.125	.750
WKI-12	.7500	.978	1.312	.875
WKI-16	1.0000	1.269	1.750	1.375

Dimensions (inch)
igubal® Spherical Balls WEI

Part No.	d1 E10	dn	dK	B
WEI-03	.1900	.354	.402	.1900
WEI-04	.2500	.314	.402	.2500
WEI-05	.3125	.415	.520	.3125
WEI-06	.3750	.506	.630	.3750
WEI-07	.4375	.581	.709	.4063
WEI-08	.5000	.581	.709	.4063
WEI-10	.6250	.802	.945	.5000
WEI-12	.7500	.951	1.138	.6250
WEI-16	1.0000	1.180	1.398	.7500

Dimensions (mm)
igubal® Spherical Balls WKM

Part No.	d1 E10	dn	dK	B
WKM-02-04	2.00	3.90	5.20	4.00
WKM-03-06	3.00	5.10	7.90	6.00
WKM-05-08	5.00	7.70	11.10	8.00
WKM-06-09	6.00	8.90	12.70	9.00
WKM-08-12	8.00	10.30	15.80	12.00
WKM-10-14	10.00	12.90	19.00	14.00
WKM-12-16	12.00	15.40	22.20	16.00
WKM-14-19	14.00	16.80	25.40	19.00
WKM-16-21	16.00	19.30	28.50	21.00
WKM-18-23	18.00	21.80	31.70	23.00
WKM-20-25	20.00	24.30	34.90	25.00
WKM-22-28	22.00	25.80	38.10	28.00
WKM-25-31	25.00	29.50	42.80	31.00
WKM-30-37	30.00	34.80	51.00	37.00

Dimensions (mm)
igubal® Spherical Balls WEM

Part No.	d1 E10	dn	dK	B
WEM-04-05	4.00	6.25	8.25	5.00
WEM-05-06	5.00	8.00	10.20	6.00
WEM-06-06	6.00	8.00	10.20	6.00
WEM-08-08	8.00	10.00	13.20	8.00
WEM-10-09	10.00	13.00	16.00	9.00
WEM-12-10	12.00	15.00	18.00	10.00
WEM-15-12	15.00	18.00	22.00	12.00
WEM-17-14	17.00	20.00	25.10	14.00
WEM-20-16	20.00	24.00	28.90	16.00
WEM-25-20	25.00	29.00	35.50	20.00
WEM-30-22	30.00	34.00	40.90	22.00

Available from stock

► Tolerance Table, Page 1.14

igubal®
Spherical Balls

PDF: www.igus.com/iglide-pdfs
CAD: www.igus.com/iglide-CAD
RoHS info: www.igus.com/RoHS





igubal® Spherical Bearings
Spherical Balls - inch, mm - REI, REM, RKM
Spherical Ball - mm - XKM, XEM

igubal®
Spherical Balls

Telephone 1-800-521-2747
 Fax 1-401-438-7270

Internet: <http://www.igus.com>
 email: sales@igus.com
 QuickSpec: <http://www.igus.com/iglide-quickspec>

igubal® Spherical Balls - REI, REM, RKM

Low Cost – iglide® R, low friction values, low cost, low moisture absorption

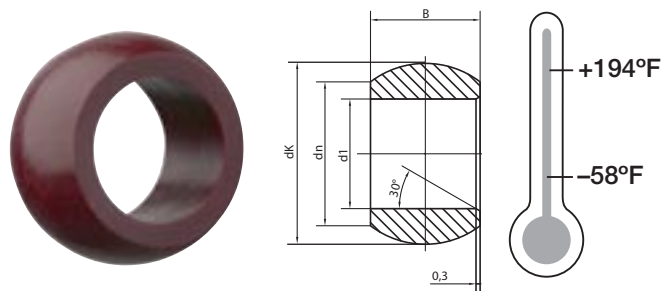
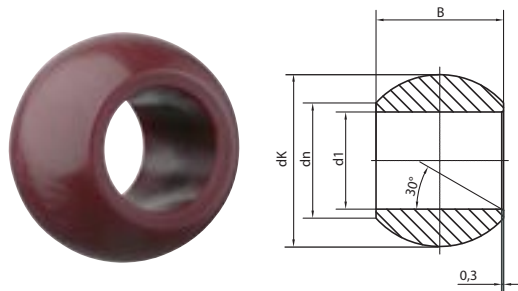

Dimensions (Inch)

igubal® Spherical Bearings REI

Part No.	d1 E10	dn	dK	B
REI-03	.1900	.354	.402	.1900
REI-04	.2500	.314	.402	.2500
REI-05	.3125	.415	.520	.3125
REI-06	.3750	.506	.630	.3750
REI-07	.4275	.581	.709	.4063
REI-08	.5000	.581	.709	.4063
REI-10	.6250	.802	.945	.5000
REI-12	.7500	.951	1.138	.6250
REI-16	1.0000	1.180	1.138	.7500

Dimensions (mm)

igubal® Spherical Bearings REM

Part No.	d1 E10	dn	dK	B
REM-05-06	5.00	8.00	10.20	6.00
REM-06-06	6.00	8.00	10.20	6.00
REM-08-08	8.00	10.00	13.20	8.00
REM-10-09	10.00	13.00	16.00	9.00
REM-12-10	12.00	15.00	18.00	10.00

Dimensions (mm)

igubal® Spherical Bearings RKM

Part No.	d1 E10	dn	dK	B
RKM-10-14	10.00	12.90	19.00	14.00

igubal® Spherical Balls - XKM, XEM

High Temperatures – iglide® T500, resistant to chemicals, high temperatures

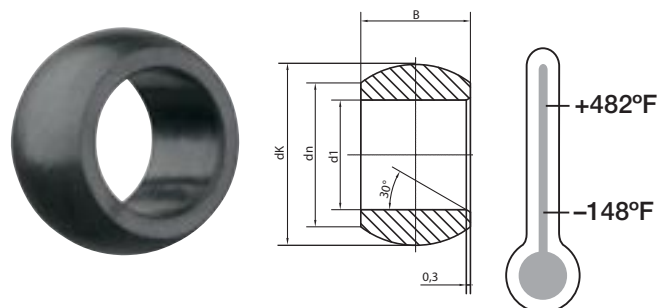
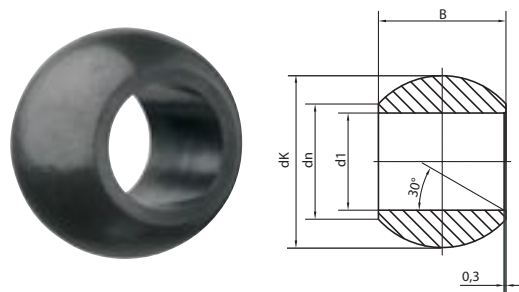

Dimensions (mm)

igubal® Spherical Bearings XKM

Part No.	d1 E10	dn	dK	B
XKM-10-04	10.00	12.90	19.00	14.00

Dimensions (mm)

igubal® Spherical Bearings XEM

Part No.	d1 E10	dn	dK	B
XEM-06-06	6.00	8.00	10.20	6.00
XEM-08-08	8.00	10.00	13.20	8.00
XEM-10-09	10.00	13.00	16.00	9.00
XEM-12-10	12.00	15.00	18.00	10.00

Available for delivery

► Tolerance Table, Page 1.14



igubal® Spherical Balls - JKM, JEM

Low moisture absorption – iglide® J; low friction values

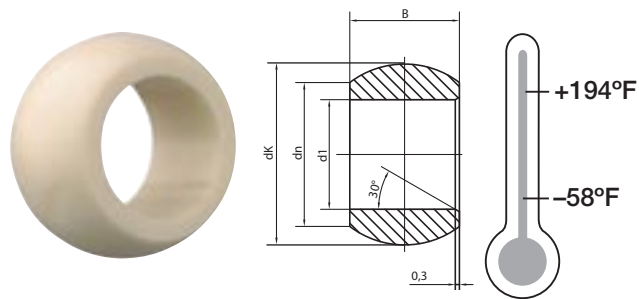
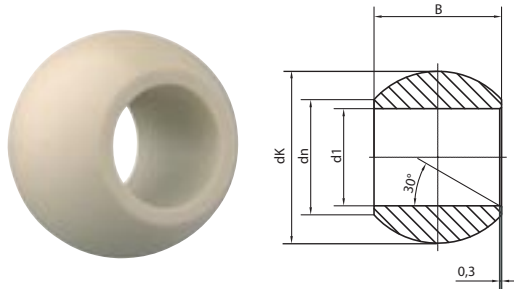

Dimensions (mm)
igubal® Spherical Bearings JKM

Part No.	d1 E10	dn	dK	B
JKM-10-04	10.00	12.90	19.00	14.00

Dimensions (mm)
igubal® Spherical Bearings JEM

Part No.	d1 E10	dn	dK	B
JEM-04-05	4.00	6.25	8.25	5.00
JEM-05-06	5.00	8.00	10.20	6.00
JEM-06-06	6.00	8.00	10.20	6.00
JEM-08-08	8.00	10.00	13.20	8.00
JEM-10-09	10.00	13.00	16.00	9.00
JEM-12-10	12.00	15.00	18.00	10.00
JEM-15-12	15.00	18.00	22.00	12.00
JEM-16-13	16.00	19.50	24.00	13.00
JEM-17-14	17.00	20.00	25.10	14.00
JEM-20-16	20.00	24.00	28.90	16.00
JEM-25-20	25.00	29.00	35.50	20.00
JEM-30-22	30.00	34.00	40.90	22.00

igubal® Spherical Balls - UWEM

Underwater applications – iglide® UW

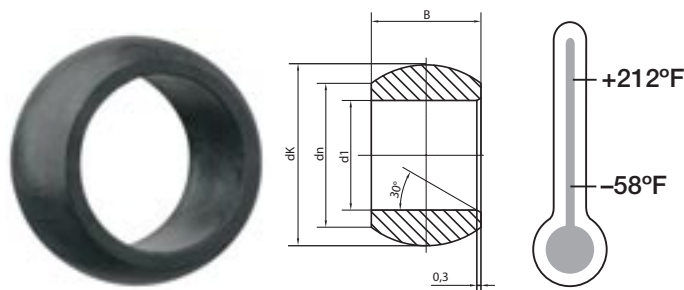

Dimensions (mm)
igubal® Spherical Bearings UWEM

Part No.	d1 E10	dn	dK	B
UWEM-16-13	16.00	19.50	24.00	13.00
UWEM-17-14	17.00	20.00	25.10	14.00
UWEM-25-20	25.00	29.00	35.50	20.00
UWEM-30-22	30.00	34.00	40.90	22.00

igubal®
Spherical Balls

PDF: www.igus.com/iglide-pdfs
CAD: www.igus.com/iglide-CAD
RoHS info: www.igus.com/RoHS





igubal® Spherical Balls -J4VEM

Low moisture absorption – iglide® J4; clearance-free

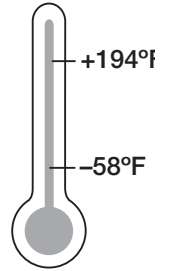
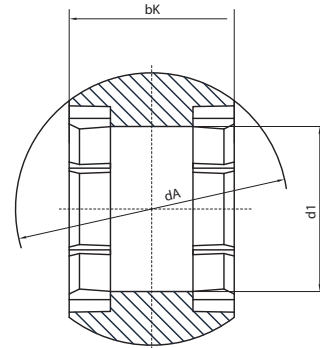
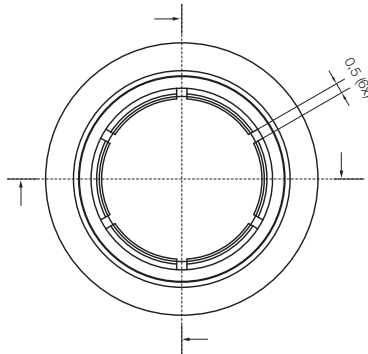

Special Properties

- Can be combined with all housings from design range E
- Sizes 8 to 20 mm
- Pre-loaded
- Totally free from clearance. even in unloaded state
- Material: iglide® J4

5 Sizes available: Ø 8, 10, 12, 16, 20 mm

Can be used in combination with:

igubal® Rod End Bearing	EB(L)RM	➤ Page 35.12
igubal® Rod End Bearing	EA(L)RM	➤ Page 35.17
igubal® Pillow Block Bearing	ESTM	➤ Page 37.8
igubal® Flange Bearing	EFOM	➤ Page 38.6
igubal® Flange Bearing	EFSM	➤ Page 38.8
igubal® Pressfit Bearing	EGLM	➤ Page 39.7
igubal® Pressfit Bearing	EGFM	➤ Page 39.13
igubal® Double Joint	EGZM	➤ Page 39.15

Dimensions (mm)

Clearance-free Spherical Bearing

Part No.	d1 E10	dA	bK
J4VEM-08-08	8	13.2	8
J4VEM-10-09	10	16.0	9
J4VEM-12-10	12	18.0	10
J4VEM-16-13	16	24.0	13
J4VEM-20-16	20	28.9	16

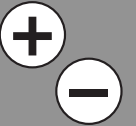



igubal® Spherical Bearings
Spherical Balls

igubal®
Spherical Balls

Telephone 1-800-521-2747
Fax 1-401-438-7270

Internet: <http://www.igus.com>
email: sales@igus.com
QuickSpec: <http://www.igus.com/iglide-quickspec>

General Index

iglide® Design

Plain bearings function	1.2
Base plastics/technical fibers	1.3
Compressive strength	1.3
Pressure and temperature	1.4
Pressure and speed	1.4
Pressure and wear	1.4
Pressure and COF	1.4
Surface speed	1.5
Surface speed and wear	1.5
Surface speed and COF	1.5
P x V value	1.6
Lubrication	1.6
Temperatures	1.7
Temperature and load	1.7
Coefficient of thermal expansion	1.8
Coefficient of friction	1.8
Coefficient of friction and surfaces	1.8
Wear resistance	1.9
Wear and load	1.9
Wear and temperatures	1.9
Wear during abrasive dirt accumulation	1.9
Wear and surfaces	1.10
Shaft materials	1.11
Chemical resistance	1.12
Use in the food industry	1.12
High energy radiation	1.13
UV-radiation	1.13
Vacuum	1.13
Electrical properties	1.13
Tolerances and measuring system	1.14
Machining	1.15
Installation	1.15
Adhesion	1.15
Complete chemical resistance table	1.16
Troubleshooting	1.20

iglide® Materials

M250	2.1
R	3.1
J	4.1
GLW	5.1
G300	6.1
L280	7.1
Q	8.1
P	9.1
H370	10.1
A180	11.1
A200	12.1

T500	13.1
X6	14.1
Z	15.1

Special Bearings

Xiros	16.1
PRT	17.1
Clips	18.1
Clips2	19.1
JV	20.1
Piston Rings	21.1
Bar Stock	22.1
Flange bearing	23.1
Polysorb disc springs	24.1

DryLin® Design

System comparison	25.2
System properties	25.4
Features & benefits	25.6
Bearing materials	25.7
Loading capacity	25.8
Permissible speeds	25.8
The 2:1 Rule	25.8
Coefficients of friction	25.9
Wear behavior	25.10
Stick-slip behavior	25.10
Operating temperatures	25.10
Chemical resistance	25.11
Corrosion behavior	25.11
Cleanroom suitability	25.12
Fixed & floating mounting instructions	25.13
Application examples	25.15

DryLin® N

DryLin® N overview	26.2
Design	26.4
N17	26.8
N27	26.9
N27 Double Length	26.10
N27 Preloaded	26.11
N40	26.12
N80	26.13

DryLin® W

DryLin® W overview	27.2
Design	27.4
Style options	27.5
Sliding elements	27.6
Mounting instructions	27.6
Technical information	27.7

Design notes	27.8
Design Rules	27.9
Single rail square	27.10
Single rail round	27.12
Double rail square	27.14
Double rail round	27.16
Accessories	27.18
Hybrid linear bearing	27.20
Stainless Steel	27.22

DryLin® T

DryLin® T overview	28.2
Design	28.4
Adjustable clearance	28.8
Automatic clearance	28.9
Manual clamping	28.10
Heavy Duty	28.12
Miniature	28.13
Adjusting the clearance	28.14
Calculation variables	28.15
Mounting - horizontal	28.16
Mounting - lateral	28.17
Mounting - vertical	28.18

DryLin® R

Design	29.2
Testing method	29.57
Analysis worksheet	29.68

Linear Bearings - Inch

Liners	29.9
RJUI-01/21	29.12
RJUI-03/23	29.13
TJUI-01/21	29.14
TJUI-03/23	29.15
OJUI-01/21	29.16
OJUI-03/23	29.17

Pillow Blocks - Inch

RJUI-XX	29.18
OJUI-XX	29.19
RJUI-XX (Twin)	29.20
OJUI-XX (Twin)	29.21
FJUI-XX (Flange)	29.22
FJUIT-XX (Twin flange)	29.22

Shafting - Inch

AWI (Aluminum)	29.23
AWUI (Aluminum supported)	29.23

General Index

Linear Bearings - Metric

Liners	29.24
RJUM-01	29.28
RJUM-21	29.29
RJUM-03	29.30
RJUM-23	29.31
TJUM-01	29.32
TJUM-21	29.33
TJUM-03	29.34
TJUM-23	29.35
OJUM-01	29.36
OJUM-21	29.37
OJUM-03	29.38
OJUM-23	29.39
RJUM-02	29.40

Pillow Blocks - Metric

RJUM-05	29.41
RJUME-05 (Short)	29.42
RJUM-06 (Long)	29.43
RJUM-06 LL (Floating)	29.44
TJUM-05 (Split)	29.45
OJUM-06 (Open, long)	29.46
OJUME-06 (Open, long adjustable)	29.47
OJUM-06 LL (Open-floating)	29.48
FJUM-01 (Round flange)	29.49
FJUM-02 (Square flange)	29.50
FJUMT-01 (Round twin flange)	29.51
FJUMT-02 (Square twin flange)	29.52
RQA (Quad block-closed)	29.53
OQA (Quad block-closed)	29.53
RTA (Twin-closed)	29.54
OTA (Twin-open)	29.54
RGA (Closed-long)	29.55
OGA (Open-long)	29.55
RGAS (Closed-short)	29.56
OGAS (Open-short)	29.56

Shafting - Metric

AWM (Aluminum)	29.61
AWUM (Aluminum supported)	29.61
SWM	29.62
SWUM/SWUMN	29.63
EWM/EEWM	29.64
EWMR/ EWMS	29.64
EWUM/EWUMN	29.65
WA (Shaft block)	29.66
WAC (Shaft block-compact)	29.66
WAS (Shaft block-narrow)	29.67
TA (Shaft support-moveable)	29.68
TAF (Shaft support-fixed)	29.68

DryLin Drive Technology

System overview & properties	30.2
Application examples	30.4
Design	30.6
SLW	30.10
SLW (Hi-Helix)	30.11
SLW-PL (Preload)	30.12
SLWE-BB (Ball bearing)	30.13
SLW-XY	30.14
SLW-ES (Stainless)	30.15
SLW-XY (Stainless)	30.16
HTS (Basic)	30.17
HTS-PL (Adjustable clearance)	30.18
HTSS (Fast pitch)	30.19
HTS-FF (Fast forward)	30.20
HTS-PL XY	30.21
HTSC (Compact)	30.22
HTS-HYD (Hygienic design)	30.23
HTSP (Small, low-cost)	30.24
HTSP	30.25
HTSP-FF (Fast forward)	30.26
SET (Easy tube)	30.27

Drive Technology Accessories

Position indicator	30.30
Rotary knob	30.31
Hand wheel	30.31
HTS-WT V-Drive	30.32
Spacer	30.33
Motor Flange	30.33
Coupling	30.33

Belt Drive

Design	30.34
ZLW 0630	30.36
ZLW 1040	30.38
ZAW	30.40

Belt Drive Accessories

Clamp	30.41
Slot Nuts	30.41
Screw connection	30.41
Motor flange	30.29

Trapezoidal Lead Screw Nuts

Design	31.2
Application examples	31.3
PTGSG (Threaded spindle)	31.6
WSRM	31.7
JSRM	31.8
WFRM	31.9
JSR	31.10

PTGSG (Hi-Helix)	31.11
JSR (Round nut Hi-Helix)	31.11
Nuts with flange (Hi-Helix)	31.11
Lead screw end blocks	31.12
Quick release nuts	31.13

DryLin® Stainless

DryLin® W double rail	32.3
DryLin® W block	32.3
DryLin® W single rail	32.4
DryLin® W block	32.4
RJUM-01	32.5
EWM/EEWM Shafting	32.6
EWMR/EWMS Shafting	32.6
EWUM/EWUMN Shafting	32.7
EWUM/EWUMS Supported shafting	32.8
SLW-ES (Stainless)	32.9
HTSC-HYD (Hygienic design)	32.10
SLW-XY (Stainless)	32.11

DryLin® Specialists

Overview	33.2
WJRM	33.3
Telescopic systems	33.4
Measuring systems	33.6
DryLin® Q Square guide	32.5

igubal® Design

System overview	34.2
igubal® advantages	34.4
Loads	34.5
Coefficients of friction	34.5
Temperatures	34.5
Chemical resistance	34.5
Radiation resistance	34.6
UV resistance	34.6
Material tables	34.7

igubal® Rod Ends

Overview	35.2
Application examples	35.3
Design	35.4
KBRI/KBLI	35.6
EBRI/EBLI	35.7
KBRM/KBLM	35.8
KBRM CL	35.10
KGRM/KCLM	35.11
EBRM/EBLM	35.12
EBRM/EBLM HT (High Temp)	35.13
KARI/KALI	35.14

General Index

KARM/KALM	.35.15
KARM CL	.35.16
EARM/EALM	.35.17
EARM/EALM HT (High Temp)	.35.18
PKRM (Adjusting bolt)	.35.19
WGRM/WGLM	.35.20
WGRM LC/WGLM LC	.35.21
AGRM/AGLM	.35.22
AGRM LC/AGLM LC	.35.22

Clevis Joint

Overview	.36.2
Application examples	.36.3
Design	.36.4
GERI/GELI	.36.5
GERM/GELM	.36.6
GERIK/GELIK	.36.7
GERMK/GELMK	.36.8
GERMKE/GELMKE	.36.9
GEFM (Spring loaded pin)	.36.9
GERMF/GELMF	.36.10
GERMFE/GELMFE	.36.11
GBI/GBM (Clevis pin)	.36.12
GSR (Clevis clip)	.36.12

igubal® Pillow Block

Overview	.37.2
Application examples	.37.3
Design	.37.4
KSTI	.37.6
KSTM	.37.7
ESTM	.37.8
AD-ESTM	.37.9
ESTM-GT	.37.10
ESTM SL	.37.11
KSTM-GT	.37.12

igubal® Flange Bearing

Overview	.38.2
Application examples	.38.3
Design	.38.4
EFOI (Two bolt-inch)	.38.5
EFOM (Two bolt-metric)	.38.6
EFSI (Four bolt-inch)	.38.7
EFSM (Four bolt-metric)	.38.8
KFSM-GT	.38.9
EFOM HT (High temperature)	.38.10
EFSM HT (High temperature)	.38.11

Pivoting Bearing

Overview	.39.2
Application examples	.39.3
Design	.39.4
KGLI	.39.5
KGLM	.39.6
EGLM	.39.7
KGLI SL	.39.8
KGLM SL (Slimline)	.39.9
KGLM LC (Low-cost)	.39.10
KGLM H (Split)	.39.11
ECLM (Clip)	.39.12
EGFM T	.39.13
ECLM HD (Clip-Heavy duty)	.39.14
EGZM (double joint)	.39.15
KDGM	.39.16
WDGM	.39.17
EGXM	.39.18
SAM	.39.19

Spherical Balls

Overview	.40.2
Application examples	.40.3
Design	.40.4
WKI/WEI (L280 material-inch)	.40.5
WKM/WEM (L280 material-metric)	.40.5
REI/REM/RKM (R material-metric)	.40.6
XKM/XEM (T500 Material - metric)	.40.6
JKM/JEM (J material-metric)	.40.7
UWEM (UW material-metric)	.40.7
J4VEM (J4 material-clearance free)	.40.8

North American Contacts



igus CANADA

Concord, Ontario
 PHONE: (800) 965-2496
 (905) 760-8448
 FAX: (905) 760-8688

Blainville, Quebec
 PHONE: (405) 419-6506
 FAX: (405) 419-5742

Cochrane, AB
 PHONE: (403) 604-0627
 FAX: (403) 981-3294

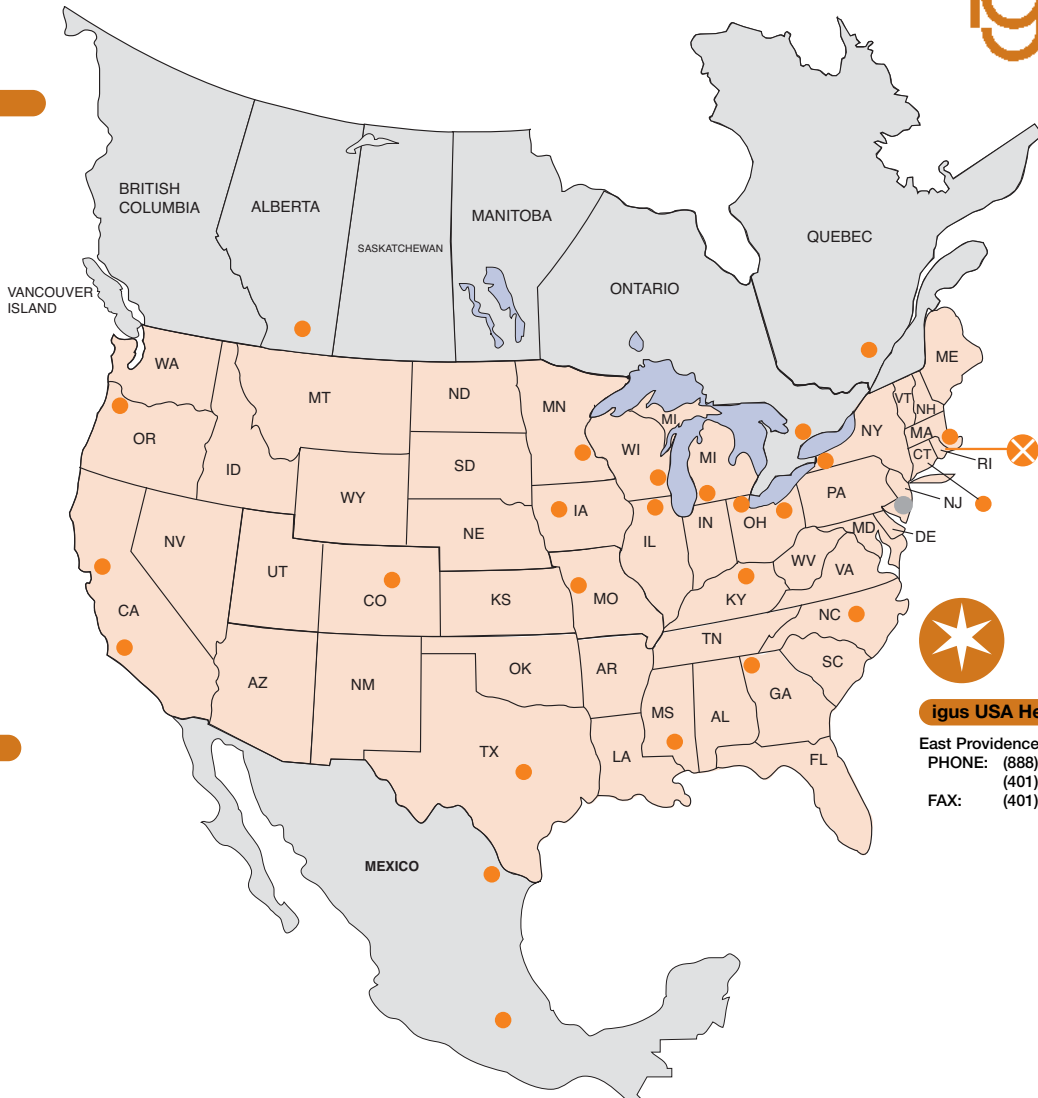

igus USA Headquarters

East Providence, RI
 PHONE: (888) 803-1895
 (401) 438-2200
 FAX: (401) 438-7680

igus MEXICO

Nuevo Leon, Mexico
 PHONE/FAX: (818) 105-4276

Toluca, Mexico
 PHONE: (722) 271-4273
 FAX: (722) 271-4274

igus NORTHERN CALIFORNIA

San Francisco, CA
 PHONE: (415) 593-7747
 FAX: (503) 282-5976

igus SOUTHERN CALIFORNIA

Orange, CA
 PHONE: (714) 283-1165
 FAX: (714) 283-2561

igus COLORADO

Denver, CO
 PHONE: (303) 495-3722
 FAX: (503) 282-5976

igus CONNECTICUT

Kensington, CT
 PHONE: (860) 356-2238
 FAX: (860) 770-6408

igus GEORGIA

Ringgold, GA
 PHONE: (404) 437-6995
 FAX: (404) 437-6383

igus ILLINOIS

Elmhurst, IL
 PHONE: (630) 559-0847
 FAX: (630) 559-0856

igus IOWA

Iowa City, IA
 PHONE: (319) 248-9841
 FAX: (319) 248-9823

igus KENTUCKY

Fort Thomas, KY
 PHONE: (513) 831-7910
 FAX: (513) 831-7920

igus MASSACHUSETTS

PHONE: (401) 484-2140
 FAX: (401) 438-7680

igus MICHIGAN

Toledo, OH
 PHONE/FAX: (419) 478-8765
 Kalamazoo, MI (Auto)
 PHONE/FAX: (269) 372-7370

Midlantic Co.

Pennsauken, NJ
 PHONE: (856) 486-7711
 FAX: (856) 486-7677

igus MINNESOTA

Eden Prairie, MN
 PHONE: (952) 974-3235
 FAX: (952) 974-3236

igus MISSOURI

Kansas City, MO
 PHONE: (913) 538-7427
 FAX: (913) 538-6158

igus MISSISSIPPI

Perkinston, MS
 PHONE: (573) 309-6959

igus NEW YORK

Hamburg, NY
 PHONE: (888) 803-9220
 (716) 648-4500
 FAX: (716) 648-3229

igus NORTH CAROLINA

Wake Forest, NC
 PHONE: (919) 341-2322
 FAX: (919) 341-8532

igus OHIO

Stow, OH
 PHONE: (330) 931-3898
 FAX: (330) 931-3900

igus OREGON

Portland, OR
 PHONE: (888) 803-7237
 (503) 282-1952
 FAX: (503) 282-5976

igus TEXAS

Corinth, TX
 PHONE: (281) 348-9516
 FAX: (281) 348-9517

igus WISCONSIN

Sussex, WI
 PHONE: (888) 803-7235
 (262) 246-0682
 FAX: (262) 246-0689

igus® worldwide

igus® offices

igus® distributors

USA

igus® inc.
50 N. Broadway
P.O. Box 14349
East Providence, RI 02914
Phone +1-401-438 22 00
Fax +1-401-438 72 70
webmaster@igus.com

Germany

igus® GmbH
Spicher Str. 1a
51147 Köln (Porz-Lind)
PO Box 90 61 23
51127 Cologne
Phone +49-22 03-96 49-0
Fax +49-22 03-96 49-222
info@igus.de, www.igus.de

Australia

Treotham Automation Pty. Ltd.
Unit 36, 9 Powells Road,
Brookvale NSW 2100
Phone +61-2-99 07 17 88
Fax +61-2-99 07 17 78
info@treotham.com.au

Austria

**igus® Polymer
Innovationen GmbH**
Ort 55
4843 Ampflwang
Phone +43-76 75-40 05-0
Fax +43-76 75-32 03
igus-austria@igus.at

Argentina

Borimport S.R.L.
Guevara 275 (C1427BRE)-
Capital Federal
Buenos Aires, Argentina
Phone/Fax +54-11-4556-1000
igus@borimport.com

Belgium

igus® B.V.B.A.
Kolonel Begaultlaan 75
3012 Wilsele
Phone +32-16-31 44 31
Fax +32-16-31 44 39
info@igus.be

Brazil

igus® do Brasil Ltda.
Av. Eng. Alberto de Zagottis 655
Santo Amaro
04675-085 São Paulo - SP
Phone +55-11-35 31 44 87
Fax +55-11-35 31 44 88
vendas@igus.com.br

Bulgaria

Atlas Technik EOOD
BG-1612 Sofia
PK 51
Phone +359-885-23 25 95
+359-897-98 16 69
Phone/Fax +359-2-859 76 81
al_popoff@techno-link.com

Bulgaria

Hennlich OOD, BG
4000 Plovdiv
Konstantin Velichkov, 69, Et. 3
Phone +359-32-511 326
Phone/Fax +359-32-621 929
office@hennlich.bg

Canada

igus® Office Canada
201 Millway Ave. Unit 25
Concord
Ontario L4K 5K8
Phone +1-905-760 84 48
Fax +1-905-760 86 88
webmaster@igus.com

China

igus® Shanghai Co., Ltd
No 28 Jiatai Road,
Waigaoqiao Free Trade Zone
Shanghai 200021, P.R.C
Phone +86-21-51 30 31 00
Fax +86-21-51 30 32 00
master@igus.com.cn

China South

igus® China Guangzhou office
Room 2306, West Tower,
Yangcheng International Commercial
Center, Tiyu, East Road,
Guangzhou 510620, P.R.C
Phone +86-20-38 87 17 26
Fax +86-20-38 87 17 68
guangzhou@igus.com.cn

Croatia

Hennlich, Industrijska d.o.o.
Franje Wöfla 4
10000 Zagreb
Phone +385-1-3 87 43 34
Fax +385-1-3 87 43 36
hennlich@hennlich.hr

Czech Republic

Hennlich Industrietechnik spol. s r.o.
o.z. Lin-tech
Českolipská 9
412 01 Litoměřice
Chains +420-416-71 13 32
Bearings +420-416-71 13 39
Fax +420-416-71 19 99
lin-tech@hennlich.cz

Denmark

igus® ApS
Postboks 243
8800 Viborg
Phone +45-86-60 33 73
Fax +45-86-60 32 73
info@igus.dk

Denmark – E-Chains®

Solar AS
Industrivej Vest 43
6600 Vejien
Phone +45-76-96 12 00
Fax +45-75-36 47 59
solar@solar.dk

Finland – E-Chains®

SKS-mekanikka Oy
Martinkyläntie 50
01720 Vantaa
Phone +358-9-85 26 61
Fax +358-9-85 26 824
mekanikka@skks.fi

Finland – Chainflex®

SKS-automaatio Oy
Martinkyläntie 50
01720 Vantaa
Phone +358-9-85 26 61
Fax +358-9-85 26 820
automaatio@skks.fi

France

igus® SARL
49, avenue des Pépinières
Parc Médicis
94832 Fresnes Cedex
Phone +33-1-49 84 04 04
Fax +33-1-49 84 03 94
info@igus.fr

Greece – Energy Chains®

Chrismotor s.a.
71, Sp. Patsi str.
118 55 Athens
Phone +30-210-34 25 574
Fax +30-210-34 25 595
info@chrismotor.gr

Greece – iglide® Bearings

J. & E. Papadopoulos S.A.
23, Retsina Street
185 45 Piraeus
Phone +30-210-411 31 33
Fax +30-210-411 67 81
sales@papadopoulos-sa.com

Hong Kong

Sky Top Enterprises Ltd
Room 1707, Block C; Wah Tat Ind
Centre; Wah Sing Street; Kwai
Chung; Hong Kong
Phone +852-22 43 42 78
Fax +852-22 43 42 79
skytop@ctimail.com

Hungary

igus® Hungária Kft.
Mogyoródi u.32.
1149 Budapest
Phone +36-1-306-64 86
Fax +36-1-431-03 74
info@igus.hu

Hungary

Tech-Con Kft.
Véső utca 9-11
1133 Budapest
Phone +36-1-412 41 61
Fax +36-1-412 41 71
tech-con@tech-con.hu

India

igus (India) Pvt. Ltd.
199/1, 22 nd Main
HSR Layout, Agara,
Bangalore - 560 048
Phone +91-80-25 72 71 06
Fax +91-80-25 72 71 08
sales-india@igus.de

Indonesia

Pt. Energi Canggih Indonesia
Kelapa Gading Selatan
BJ 08 / 14 Gading Serpong
Tangerang 15810
Phone +62-21-547 43 64
Fax +62-21-547 43 65
jakarta@energicanggih.com

Iran

**Tameen Ehtiajat Fani Tehran
(TAF CO.)**
72, Iranshar Ave., Unit 5
15816 Tehran, Iran
Phone +98-21-8831 78 51
Fax +98-21-8882 02 68
info@taf-co.com

Israel

Conlog LTD
P.O. Box 35 71
Petach Tikva 49134
Phone +972-3-926 95 95
Fax +972-3-923 33 67
conlog@conlog.co.il

Italy

igus® S.r.l.
Via delle Rovedine, 4
23899 Robbiate (LC)
Phone +39-039 5906.1
Fax +39-039 5906.222
igusitalia@igus.it

Japan

igus® k.k.
Arcacentral 7F, 1-2-1 Kinshi,
Sumida-ku Tokyo JAPAN, 130-
0013
Phone +81 3 58 19 20 30
Fax +81 3 58 19 20 55
info@igus.co.jp

Malaysia

**Automation Industry & Systems
(M) SDN.BHD.**
50, Lorong Nagasari 11,
Taman Nagasari, 13600 Prai, Penang
Phone +60-4-390 56 07
Fax +60-4-399 73 27
autoind@pgo.jaring.my

Mexico

igus® México S. de R.L. de C.V.
Av. Tecnológico 496 Nite
Col. Agrícola-Bellavista
52149 Toluca
Phone +52-722-27 14 273
Fax +52-722-27 14 274
fmarquez@igus.com

27 Netherlands

igus® Nederland
Sterrenbergweg 9
3769 BS Soesterberg
Phone +31-346-35 39 32
Fax +31-346-35 38 49
igus.nl@igus.de

Netherlands – Bearings

Elcee Holland BV
Kamerlingh Onnesweg 28
NL-3316 GL Dordrecht
Phone +31-78-654 47 77
Fax +31-78-654 47 33
info@elcee.nl

New Zealand

Automation Equipment Ltd.
P.O. Box 5656 Frankton
45 Colombo Street
Frankton, Hamilton
Phone +64-7-847 20 82
Fax +64-7-847 71 60
sales@autoequip.co.nz

Norway / Iceland

ASI Automatikk AS
Ingv. Ludvigsgensgate 23
3007 Drammen
Phone +47-32-82 92 90
Fax +47-32-82 92 98
info@asiautomatikk.no

Poland

igus® Sp zo.o
ul. Parowcowa 10 b
02-445 Warszawa
Phone +48-22-863 57 70
Fax +48-22-863 61 69
igus.pl@igus.com.pl

Portugal

igus® Lda.
R. Eng. Ezequiel Campos, 239
4100-231 Porto
Phone +351-22-610 90 00
Fax +351-22-832 83 21
info@igus.pt

Romania

TechCon Industry SRL
Calea Crangasi nr. 60
Bucuresti 060346
Phone +40-21-2219-640
Fax +40-21-2219-766
automatizari@meteor.ro

Romania

Hennlich S.R.L.
Str. Patria, Nr17
310106 Arad
Phone +40-257-21 10 19
Fax +40-257-21 10 21
stein@hennlich.ro

Russia

Eka-Service Kompani
1-aja Dubrowskaja, 2A, k. 35
109044 Moskau
Phone +7-495-632 66 23
Fax +7-495-677 17 78
info@ekaservice.ru

Serbia

Hennlich doo Beograd
Ul. S. Markovica 3/4
11400 Mladenovac
Phone +381-11 82 36 002
Fax +381 11 23 17 815
office@hennlich.rs

Singapore – HQ ASEAN

igus® Singapore Pte Ltd.
15 Shaw Road, #03-02 Singapore
367953
Phone +65-64 87 14 11
Fax +65-64 87 15 11
Malaysia-Hotline +60-12-709 30 41
Thailand-Hotline +66-9-160 73 69
asia-sales@igus.de

Slovakia

Hennlich Industrietechnik s.r.o.
Kašicka 52
821 08 Bratislava
Phone +421-2-50 20 43 08
Fax +421-2-50 20 43 11
technik@hennlich.sk

Slovenia

Hennlich, d.o.o.
Industrijska tehnika
Podnart 33
SI-4244 Podnart
Phone +386-4-532 06 10
Fax +386-4-532 06 20
info@hennlich.si

South Africa

igus® Pty. Ltd.
Unit 14, Heron Park
80 Corobrik Road
PO Box 4214
4017 Riverhorse Valley
Phone +27-31-569 6633
Fax +27-31-569 6636
sales.sa@igus.de

South Korea

igus® Korea Co. Ltd.
25BL 13LT Namdong Ind. Complex
446-11 Nonhyundong, Namdonggu
Incheon City, 405-300
Phone +82-32-821 29 11
Fax +82-32-821 29 13
sales-korea@igus.de

Spain

igus® S.L.
C/ Llobatona, 6
Polígono Noi del Sucre
08840 Viladecans - Barcelona
Phone +34-93-647 39 50
Fax +34-93-647 39 51
igus.es@igus.es

Sweden

igus® ab
Knut Påls väg 8
256 69 Helsingborg
Phone +46-42-32 92 70
Fax +46-42-21 15 85
info@igusab.se

Sweden – Energy Chains®

OEM Automatic AB
Box 1011 Dalagatan 4
573 28 Tranås
Phone +46-75-242 41 00
Fax +46-75-242 41 59
info@aut.oem.se

Sweden – iglide® Bearings

incl. DryLin®:
Colly Components AB
P.O. Box 76
164 94 Kista
Phone +46-8-7030 100
Fax +46-8-7039 841
info@me.colly.se

Switzerland

igus® Schweiz GmbH
Industriestr. 11
4623 Neuendorf
Phone +41-62-38 89 797
Fax +41-62-38 89 799
info.ch@igus.ch

Taiwan

igus® Taiwan Company Limited
2F, No 82, 32nd Road
Taichung Industrial Park
40768 Taichung
Phone +886-4-23 58-1000
Fax +886-4-23 58-1100
igus-taiwan@igus.com.tw

Thailand

Autoflexible Engineering Co., Ltd.
111 Soi. Sukhumvit, 62/1
Bangjak, Phakanong
Bangkok 10260
Phone +66-2-311 21 11
Fax +66-2-332 79 00
kwanchai@autoflexible.com

Turkey

HIDREL Hidrolik Elemanlar
Sanayi ve Ticaret A.S.
Percemli Sk. No. 7
Tünel Mevkii
80000 Karaköy / Istanbul
Phone +90-212-249 48 81
Fax +90-212-292 08 50
info@hidrel.com.tr

United Kingdom

igus® UK Ltd.
51A Caswell Road
Brackmills
Northampton NN4 7PW
Phone +44-1604-67 72 40
Fax Chain +44-01604 67 72 42
Fax Bearing +44-01604 67 72 45
sales_uk@igus.co.uk

Ukraine

Cominpro Ltd.
Romana Rollana 12, Office 220
61058 Kharkov
Phone +38-057 717 49 14
Fax +38-057 717 49 14
cominpro@gmail.com

Also From **igus**[®]



The Energy Chain Systems[®] catalog features hundreds of all-plastic Energy Chain[®]/Tube cable carriers for guidance and protection of automated cables and hoses. The complete line of Chainflex[®] continuous-flex cables, and a broad range of strain relief, mounting brackets, shelving and separation accessories are also included.

IN THE USA:

P.O. Box 14349
East Providence, RI 02914
Customer Service/Sales
Tel.: 1-888-803-1895
Fax: 1-401-438-7680

IN MEXICO

Av. Tecnológico 496 Nte
Col. Agrícola-Bellavista
Toluca, Mexico 52149
Tel.: (52) 722-271-4273
Fax: (52) 722-271-4274

IN CANADA:

201 Millway Avenue, Units 24 & 25
Concord, Ontario
Canada L4K 5K8
Tel.: 1-800-965-2496
Fax: 1-905-760-8688

Website: www.igus.com

email: sales@igus.com

Or Refer to Your Local Sales Office

Listed on the Last Two Pages of this Catalog



**ISO 9001:2008
Certified**