



rolling bearings



6310



**ball bearings
needle bearings
inner rings
pillow blocks**

contents

Symbols and units in the catalog	5
Engineering data	6 - 24
Deep groove ball bearings	25 - 35
Series 6..	
Series 618/619..	
Series 60..	
Series 62..	
Series 63..	
Double-row angular contact ball bearings	36 - 37
Series 32..	
Series 33..	
Needle roller bearings	38 - 79
Series IR	
Series IRZ	
Series K	
Series HK/BK	
Series HK..RS/HK..2RS/BK..RS	
Series SCE/SCH	
Series BCE/BCH	
Series AXK/AS	
Series NTA TRA/C/D	
Series HF/HFL	
Series RC/RCB	
Series B/BH	

symbols and units in the catalogue

a_1	reliability factor
a_2	material factor
a_3	operation condition factor
B	nominal inner ring (shaft washer) width, mm
b_m	material factor
C	nominal outer ring (housing washer) width, mm
C_0	basic static load rating, kN
C_r	basic dynamic radial load rating, kN
D	bearing housing bore diameter or outer ring external diameter, mm
D	bearing nominal outer diameter, mm
D_i	inner ring raceway diameter, mm
D_w	ball diameter, mm
D_h	housing outside diameter, mm
D_e	outer ring raceway diameter, mm
D_r	mean diameter of rolling elements, mm
d	bearing nominal inner diameter, mm
d_0	hollow shaft inner diameter, mm
E_w	circumscribed circle diameter
F_r	radial load, kN
F_a	axial load, kN
F_w	inscribed circle diameter
f_m	torque load factor
f_d	impact load factor
f_1	load factor
f_2	load distribution factor
f_n	speed factor
f_h	life factor
f_c	factor related to bearing part geometry
i	row number of ball bearings or roller bearings
L	bearing basic rating life, r
L_h	bearing basic rating life, h
L_{10}	basic rating life, $10^6 r$
L_{10h}	basic rating life, h
L_{na}	adjusted rating life, $10^6 r$
M	bearing friction torque, Nm
N	allowable speed in actual bearing operation, r/min
N_0	bearing limit speed, r/min
n	speed, r/min
P	bearing equivalent load, kN
P_m	dynamic equivalent load considering torque load, kN
P_d	dynamic equivalent load considering impact load, kN
p	life index, $p=3$ for ball bearings; $p=10/3$ for roller bearings
r_s	chamfer
S	working clearance, mm
S_0	theoretical clearance, mm
S_f	clearance decrease amount caused by fit
S_{ri}	inner ring raceway diameter expansion amount, mm
S_{ro}	outer ring raceway diameter shrink amount, mm
S_{t1}	clearance decrease amount caused by inner and outer ring temperature difference, mm
S_{t2}	clearance decrease amount caused by rolling elements temperature rise, mm
t	chamfer length of IR series
t_i	inner ring temperature rise, °C
t_e	outer ring temperature rise, °C
t_r	rolling element temperature rise, °C
X	radial load factor
Y	axial load factor
Z	ball number or roller number in single-row bearings
Δ_{deff}	inner ring effective interference, mm
Δ_{Deff}	outer ring effective interference, mm
α_1	liner expansion coefficient of bearing steel, $(12.5 \times 10^{-6})/^\circ\text{C}$
α	bearing nominal contact angle

Rolling bearing structure and type

Structure

Rolling bearings are normally composed of bearing rings (inner rings, outer rings), rolling elements, cages, seals, etc. There are a number of rolling elements between inner rings and outer rings. Cages are used to keep rolling elements of a certain interval distance to avoid contact and to achieve proper lubrication. Based on the number of rows of rolling elements, bearings are divided in one-row, double-row and multi-row (three-row, four-row, etc) bearings.

◇ Ring (inner ring, outer ring)

The rolling paths of the rolling elements on the rings are called raceways. The path surface is called raceway surface. The raceways of ball bearing rings are also called raceway grooves. Generally, inner rings and outer rings are fitted with shafts and housings separately. Inner rings and outer rings of thrust bearings are called shaft washers and housing washers separately.

◇ Rolling element

Rolling elements have two kinds of balls and rollers. Rollers have various types, e.g. short cylindrical rollers, needle rollers, taper rollers, spherical rollers and etc.

◇ Cage

Cages partly surround the rolling elements and keep them of a certain distance in circumferential direction. Cages include pressed cages, machined cages, plastic cages, etc. Compared with full complement bearings, bearings with cages have lower friction torque and are suitable for high speed applications.

Type

Contact angle: for loaded bearings, the loading direction between rings and rolling elements and the surface vertical to bearing center line form an angle, which is called contact angle. Based on different contact angle α , bearings can be divided in:

- * radial bearings ($\alpha = 0^\circ$) mainly sustain radial load
- * radial angular contact bearings ($0^\circ < \alpha \leq 45^\circ$) mainly sustain axial and radial combined load
- * thrust angular contact bearings ($45^\circ < \alpha \leq 90^\circ$) mainly sustain axial load

How to select rolling bearings

Bearings have a large variety and a wide size range. In order to select the most suitable bearing to meet the design requirements, it is necessary to make a comprehensive analysis of many aspects like operation conditions, bearing performance requirements, bearing surrounding specifications, even the market and economic factors. During bearing selection, the shaft diameter has to be determined in advance; bearing type is then decided based on bearing inner diameter, bearing mounting space, bearing arrangement and other working conditions. Next, analyze and calculate bearing life which must be enough for its working service and determine the bearing size. Bearing internal specifications like accuracy class, internal clearance, cage and lubrication method are determined as required in the end. The following figure is the normal bearing selection procedure and the conditions to be considered. It is not necessary to strictly adhere to this procedure, but the most important features must be met.

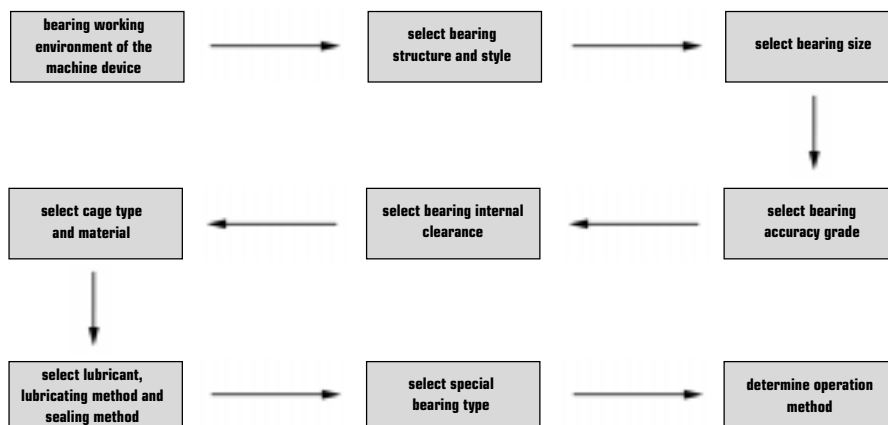





Table 1. Comparison between bearing types

name	load capacity				arrangement							
	radial load	axial load	combined load	vibration impact	high-speed	high-accuracy rotation	low noise low torque	stiffness	allowance title of inner ring and outer ring	separation of inner ring and outer ring	for fixed end	for floating end
 Deep groove ball bearings	○ ↔	○	○	△	◎	◎	◎		○	×	■ ↔	□
 Needle roller bearings	◎	×	×	○	○		○	△	■		×	■
 Thrust needle roller bearings	×	◎ ←	×	○	△		◎	×	■※			

* ◎ excellent ○ good △ common × impermissible ↔ double-direction ← single-direction ■ suitable □ suitable, but the matching surface will be used to avoid shaft shrinkage

Table 2. Bearing type selection

Bearing Types		
Bearing mounting space	As to the bearing type in the mounting space	<ul style="list-style-type: none"> the shaft diameter, i.e. bearing ID, has to be determined first because the shaft stiffness and strength are important when designing the shaft system. Bearings have various sizes, series and types. The most suitable bearing type should be chosen.
Load	Bearing load, direction and feature (bearing load capacity is expressed by basic load rating, the values are listed in the bearing dimension table)	<ul style="list-style-type: none"> Bearing load is likely to vary, e.g. variable load; only radial load or not; single direction or double-direction load; variation degree or impact strength, etc. Take all these factors into consideration to choose the most suitable bearing type. Generally, bearing radial loading capacity of the same inner ring diameter series is as follows: (deep groove ball bearings < angular contact ball bearings < cylindrical roller bearings < taper roller bearings < spherical roller bearings)
Speed	Bearing types adaptable to machinery rotation speed (Basic bearing rotation limit is expressed by the speed limit, the values are listed in the bearing dimension table)	<ul style="list-style-type: none"> Bearing speed limit does not only depend on bearing type, but also on bearing dimension, cage type, accuracy class, loading condition, lubrication method and etc. Therefore why all this information must be considered when choosing bearings. Bearings listed below are used for high-speed rotation speed: (deep groove ball bearings; angular contact ball bearings; cylindrical roller bearings)
Running accuracy	Bearing types meeting running accuracy requirements (Bearing dimension tolerance and running accuracy have been standardized according to JIS)	Machine tool spindles, turbine engines and control devices require high running accuracy, high speed and low friction bearings. Above tolerance class 5 bearings are the choice. Bearings listed below are for these applications (deep groove ball bearings; angular contact ball bearings; cylindrical roller bearings)
Stiffness	Bearing types meeting stiffness requirements of the machinery shaft system (lower elastic deformation at the contact position between rolling elements and raceways for loaded bearings)	<ul style="list-style-type: none"> As to machine tool spindles and the end-step speed-reducing devices, not only bearing stiffness must be improved, but also its stiffness. Roller bearings have smaller deformation than ball bearings. Preload (negative clearance) can improve bearing stiffness. The method applies to angular contact ball bearings and taper roller bearings.
Relative title of inner rings and outer rings	Analyze the factors affecting the relative title of inner rings and outer rings (e.g. shaft bending caused by load; bad accuracy of the shaft and housing or mounting error), and choose appropriate bearing types according to these factors (bearing allowance title angles (or aligning angle) are listed in front of bearing dimension tables.)	<ul style="list-style-type: none"> If the angle between inner rings and outer rings is too large, bearing will be damaged by inside load. Choose appropriate bearing types to deal with this kind of title. Generally, allowance title angle (or aligning angle) increases in the following order (cylindrical roller bearings < taper roller bearings < deep groove ball bearings (angular contact ball bearings) < self-aligning roller (ball) bearings)
Mounting and dismounting	Inspection frequency and dismounting method	<ul style="list-style-type: none"> When frequent mounting and dismounting are required, choose separable cylindrical roller bearings, needle roller bearings and taper roller bearings.

Select bearing size

◇ Bearing life

When bearings are rotating under load, the bearing ring raceway and the rolling surfaces of rolling elements continuously have a kind of changing-load action. Even in normal working conditions, fish scale damages appear on the raceways because of material fatigue (referred to as spalling or flaking).

The total round number ahead of this rolling fatigue damage is called bearing fatigue life.

Even bearings of the same structure, size, material and manufacturing method, working in the same conditions, bearing fatigue different. This is due to the fatigue dispersion of the material itself and should be considered from a statistical aspect.

Therefore, when the same batch of bearings rotate under same conditions, bearing basic rating life (i.e. 90% reliability life) refers to the total round number, at which 90% bearings will not have rolling fatigue damage. If the bearings rotate at a fixed speed, it can be expressed by the total rotating hours.

But in actual operation, apart from rolling fatigue damage, other kinds of damages may also appear (e.g. wear, burn, creep, indentation, fracture etc.), which can be avoided by correct selection of bearing type, bearing mounting and lubrication.

◇ Bearing life calculation

• Dynamic equivalent load

Most bearings sustain combined load of radial load and axial load. The load and its direction are changing all the time, it is not appropriate to compare actual load with basic dynamic rating load directly.

At this time, the actual load has to be assumed as a fixed load, which passes through the bearing center in one direction. Bearings have the same life under the assumed load as they are under actual load. This converted assumed load is called dynamic equivalent load and is expressed as P .

• Basic dynamic load rating

Bearing basic dynamic load rating is determined at assumed conditions. The loading condition is that radial bearings only have radial load, while thrust bearings only have axial load. Actually, in most applications, bearings sustain radial and axial load simultaneously. So in bearing life calculation, the actual load must be changed to dynamic equivalent load which is in accordance with dynamic load rating. Radial dynamic equivalent load is a constant radial load, expressed as C_r . Axial dynamic equivalent load is a constant center axial load, under which rolling bearings have the same life as in actual load condition. It is expressed as C_a .

◇ Radial ball bearing

• Basic dynamic radial load rating

Basic dynamic load rating C_r for radial contact and angular contact ball bearings is:

$$\text{when } D_w \leq 25.4\text{mm, } C_r = b_m f_c (i \cos \alpha)^{0.7} Z^{2/3} D_w^{1.8}$$

$$\text{when } D_w > 25.4\text{mm, } C_r = 3.647 b_m f_c (i \cos \alpha)^{0.7} Z^{2/3} D_w^{1.4}$$

C_r	basic dynamic radial load rating, N
b_m	material factor
f_c	factor related to bearing part geometry
i	row number of ball bearings or roller bearings
α	bearing nominal contact angle
Z	ball number or roller number in single-row bearings
D_w	ball diameter, mm

Table 3 lists b_m values. Table 4 lists f_c values. These values apply to radial contact and angular contact ball bearings with their inner ring raceway curvature radius $\leq 0.52D_w$ and outer ring raceway curvature radius $\leq 0.53D_w$, and self-aligning ball bearings with the inner ring raceway curvature radius $\leq 0.53D_w$.

Bearing loading capacity may not be improved if smaller raceway curvature radius is adopted, and larger raceway curvature radius will decrease the bearing loading capacity.

Table 3. b_n values for radial ball bearings

bearing type	b_n
radial contact and angular contact ball bearings & self-aligning ball bearings	1.3
bearings with filling slots	1.1
insert bearings	1

Table 4. f_c values of radial ball bearings

$\frac{D_w \cos \alpha^a}{D_{pw}}$	single-row radial contact groove type ball bearings, single-row and double-row angular contact groove type ball bearings	double-row radial self-aligning ball bearings	single-row and double-row self-aligning ball bearings	separable single-row radial contact ball bearings (magneto bearing)
0.01	29.1	27.5	9.9	9.4
0.02	35.8	33.9	12.4	11.7
0.03	40.3	38.2	14.3	13.4
0.04	43.8	41.5	15.9	14.9
0.05	46.7	44.2	17.3	16.2
0.06	49.1	46.5	18.6	17.4
0.07	51.1	48.4	19.9	18.5
0.08	52.8	50.0	21.1	19.5
0.09	54.3	51.4	22.3	20.6
0.10	55.5	52.6	23.4	21.5
0.11	56.6	53.6	24.5	22.5
0.12	57.5	54.5	25.6	23.4
0.13	58.2	55.2	26.6	24.4
0.14	58.8	55.7	27.7	25.3
0.15	59.3	56.1	28.7	26.2
0.16	59.6	56.5	29.7	27.1
0.17	59.8	56.7	30.7	27.9
0.18	59.9	56.8	31.7	28.8
0.19	60.0	56.8	32.6	29.7
0.20	59.9	56.8	33.5	30.5
0.21	59.8	56.6	34.4	31.3
0.22	59.6	56.5	35.2	32.1
0.23	59.3	56.2	36.1	32.9
0.24	59.0	55.9	36.8	33.7
0.25	58.6	55.5	37.5	34.5
0.26	58.2	55.1	38.2	35.2
0.27	57.7	54.6	38.8	35.9
0.28	57.1	54.1	39.4	36.6
0.29	56.6	53.6	39.9	37.2
0.30	56.0	53.0	40.3	37.8
0.31	55.3	52.4	40.6	38.4
0.32	54.6	51.8	40.9	38.9
0.33	53.9	51.1	41.1	39.4
0.34	53.2	50.4	41.2	39.8
0.35	52.4	49.7	41.3	40.1
0.36	51.7	48.9	41.3	40.4
0.37	50.9	48.2	41.2	40.7
0.38	50.0	47.4	41.0	40.8
0.39	49.2	46.6	40.7	40.9
0.40	48.4	45.8	40.4	40.9

a) For the medium values of $\frac{D_w \cos \alpha}{D_{pw}}$, the value of f_c can be calculated by linear interpolation method

• Dynamic equivalent radial load

Dynamic equivalent radial load P for radial ball bearings under constant radial and axial load:

$$P = XF_r + YF_a$$

- P dynamic equivalent load, N
- F_r radial load, N
- F_a axial load, N
- X radial load factor, see table 6
- Y axial load factor, see table 6

◇ Basic rating life

The relations of basic dynamic load rating, equivalent dynamic load and basic rating life is as for the following equation

$$L_{10} = (C/P)^p$$

$$L_{10h} = (10^6/60n) (C/P)^p$$

- L_{10} basic rating life, 10^6 r
- L_{10h} basic rating life, h
- P equivalent dynamic load, kN
- C basic dynamic load rating, kN
- n rotating speed, r/min
- p life factor, $p=3$ for ball bearings and $p=10/3$ for roller bearings

In addition, as bearing steel is improving, bearing fatigue life is extended accordingly. According to EHD lubrication theory, the oil film thickness at the contact position between raceway and rolling elements will affect bearing fatigue life. Taking the above into consideration, bearing basic rating life has to be adjusted and referred to as adjusted rating life, which is expressed as for the following equation.

$$L_{na} = a_1 a_2 a_3 L_{10}$$

- L_{na} adjusted rating life, 10^6 r
- a_1 reliability factor, see table 5
- a_2 material factor
- a_3 operation condition factor

• Reliability factor

Generally, bearing fatigue life is evaluated by 90% reliability, in which $a_1=1$. For applications where reliability above 90% is required, a_1 is chosen according to table 6.

Table 5. adjusted reliability factor

reliability %	90	95	96	97	98	99
a_1	1.00	0.62	0.53	0.44	0.33	0.21

Table 6. X and Y values of radial ball bearings

bearing type	"relative bearing load" ^{a,b}		single-row bearing				Double-row bearing				e
			$\frac{F_a}{F_r} \leq e$		$\frac{F_a}{F_r} > e$		$\frac{F_a}{F_r} \leq e$		$\frac{F_a}{F_r} > e$		
			X	Y	X	Y	X	Y	X	Y	
radial deep groove ball bearing	$\frac{f_a F_a}{C_{or}}$	$\frac{F_a}{iZD_w^2}$									
	0.172	0.172				2.3			2.3	0.19	
	0.345	0.345				1.99			1.99	0.22	
	0.689	0.689				1.71			1.71	0.26	
	1.03	1.03				1.55			1.55	0.28	
	1.38	1.38	1	0	0.56	1.45	1	0	0.56	1.45	0.3
	2.07	2.07				1.31			1.31	0.34	
	3.45	3.45				1.15			1.15	0.38	
	5.17	5.17				1.04			1.04	0.42	
	6.89	6.89				1			1	0.44	
angular contact type ball bearing	$\frac{f_a F_a}{C_{or}}$	$\frac{F_a}{ZD_w^2}$									
	0.173	0.172						2.78	3.74	0.23	
	0.346	0.345						2.4	3.23	0.26	
	0.692	0.689						2.07	2.78	0.3	
	1.04	1.03	1	0			1	1.87	0.78	2.52	0.34
	1.38	1.38						1.75	2.36	0.36	
	2.08	2.07						1.58	2.13	0.4	
	3.46	3.45						1.39	1.87	0.45	
	5.19	5.17						1.26	1.69	0.5	
	6.92	6.89						1.21	1.63	0.52	
	0.175	0.172				1.88		2.18	3.06	0.29	
	0.35	0.345				1.71		1.98	2.78	0.32	
	0.7	0.689				1.52		1.76	2.47	0.36	
	1.05	1.03				1.41		1.63	2.29	0.38	
	1.4	1.38	1	0	0.46	1.34	1	1.55	0.75	2.18	0.4
	2.1	2.07				1.23		1.42	2	0.44	
	3.50	3.45				1.1		1.27	1.79	0.49	
	5.25	5.17				1.01		1.17	1.64	0.54	
	7	6.89				1		1.16	1.63	0.54	
	0.178	0.172				1.47		1.65	2.39	0.38	
0.357	0.345				1.4		1.57	2.28	0.4		
0.714	0.689				1.3		1.46	2.11	0.43		
1.07	1.03				1.23		1.38	2	0.46		
1.43	1.38	1	0	0.44	1.19	1	1.34	0.72	1.93	0.47	
2.14	2.07				1.12		1.26	1.82	0.5		
3.57	3.45				1.02		1.14	1.66	0.55		
5.35	5.17				1		1.12	1.63	0.56		
7.14	6.89				1		1.12	1.63	0.56		
$\alpha=20^\circ$	-	-			0.43	1		1.09	0.7	1.63	0.57
$\alpha=25^\circ$	-	-			0.41	0.87		0.92	0.67	1.41	0.68
$\alpha=30^\circ$	-	-	1	0	0.39	1.76	1	0.78	0.63	1.24	0.8
$\alpha=35^\circ$	-	-			0.37	1.66		0.66	0.6	1.07	0.95
$\alpha=40^\circ$	-	-			0.35	1.57		0.55	0.57	0.93	1.14
$\alpha=45^\circ$	-	-			0.33	0.5		0.47	0.54	0.81	1.34

a the allowed max value depends on bearing design (clearance and groove depth). Values in column 1 and column 2 may be adopted according to the given conditions.

b as to "relative axial load" or the medium values of the contact angle, the values of X, Y and e can be calculated by linear interpolation method

c see GB/T 4662-2003 for f_c values

engineering data

- **Material factor**

If steel has extremely small inclusion content or has been specially treated, take $a_2 > 1$. If special heat treatment leads to lower material hardness and shorter bearing life, take the corresponding smaller a_2 value. If bearings work in bad lubricating conditions, above 1 values cannot be taken.

- **Operation's condition factor**

In ideal lubrication conditions, which is enough to form elastic hydrodynamic oil films on the bearing rolling surfaces to greatly reduce the fatigue damage probability caused by surface failures, take $a_3 > 1$.

In bad lubricating condition, the dynamic viscosity of the lubricant under working temperature is $13 \text{ mm}^2/\text{s}$ for ball bearings, $20 \text{ mm}^2/\text{s}$ for roller bearings. Then take $a_3 < 1$ for extremely low speed conditions ($n \times D_w < 10000$).

To simplify calculation, take 500 hours as the base of rating life, introducing speed factor f_n and life factor f_h :

$$f_n = \left[\frac{100}{3} / n \right]^{(1/\epsilon)} \quad f_h = \left[L_{10h} / 500 \right]^{(1/\epsilon)}$$

Bearing life formula can then be changed in:

$$C = (f_h / f_n) P$$

According to bearing working speed n and expected service life L_{10h} , find f_n and f_h values from bearing life curve (table 7), then it is easy to determine the basic dynamic load rating of the available bearing.

table 7 bearing life table

ball bearing

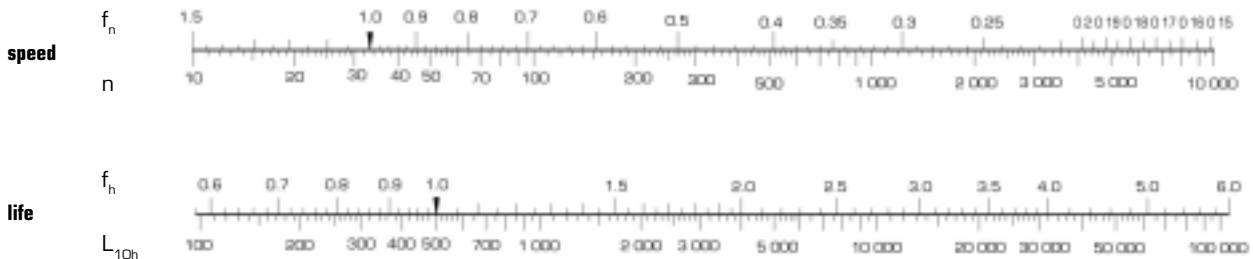

roller bearing

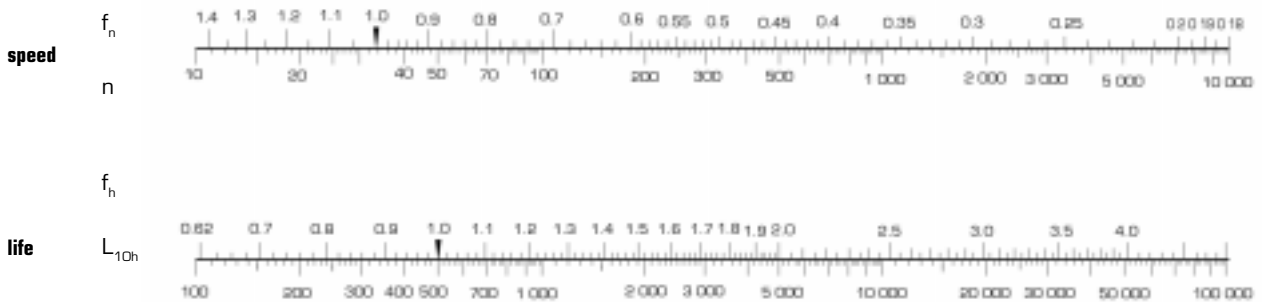

• **Dynamic equivalent load calculation**

Dynamic equivalent load calculation is as follows:

$$P = XF_r + YF_a$$

- P dynamic equivalent load, kN
- F_r radial load, kN
- F_a axial load, kN
- X radial load factor
- Y axial load factor

For single-row radial bearings, when $F_a/F_r \leq e$, take $X=1, Y=0$, therefore, dynamic equivalent load at this time is $P_r=F_r$.

For single-row angular contact ball bearings and taper roller bearings, axial component force will occur when radial loaded; normally two bearings are used in face-to-face or back-to-back arrangement. At this time, the axial component force is calculated as:

$$P_a = F_r/2Y$$

For thrust ball bearings with contact angle $\alpha = 90^\circ$, only axial load is supported, dynamic equivalent load is $P_a=F_a$.

Under constant torque load, bearing dynamic equivalent load is calculated as:

$$P_m = f_m P$$

- In which, P_m dynamic equivalent load considering torque load, kN
- f_m torque load factor (2 for large torque load, 1.5 for small torque load)

Under impact load, bearing dynamic equivalent load is calculated as:

$$P_d = f_d P$$

- in which, P_d dynamic equivalent load considering torque load, kN
- f_d impact load factor, see table 8

Table 8. impact load factor table

load	f_d	examples
no impact or little impact	1.0-1.2	motors, ventilators, water pumps
medium load	1.2-1.8	vehicles, machine tools, lifting machines, diesel engines
strong impact	1.8-3.0	destroyers, steel rolling mills, petroleum drillers

basic static load rating and static equivalent load

◇ **Basic static load rating**

If rolling bearings are used under larger static load or under impact load at low speeds, permanent deformation will occur on the contact surface between rolling elements and raceways. The deformation gets more serious as the load increases. Normal rotation will be affected once it exceeds the limit.

Basic static load rating is the static load, under which the following calculated contact stress is produced at the contact surface center between the most loaded rolling element and the raceway.

- Self-aligning ball bearings.....4600MPa
- other ball bearings.....4200MPa
- roller bearings.....4000MPa

Under this contact stress, the permanent deformation amount of rolling elements and raceways is about 0.0001 time of the rolling element diameter.

Basic static load ratings of radial bearings and thrust bearings are called basic static radial load rating and basic static axial load rating separately and expressed as C_{0r}, C_{0a} .

engineering data

◇ Static equivalent load

Static equivalent radial load of rolling bearings is a radial static load, under which equivalent contact stress of actual load conditions is produced at the contact surface center between the most loaded rolling element and the raceway. Static equivalent axial load of rolling bearings is a axial static load, under which equivalent contact stress of actual load conditions is produced at the contact surface center between the most loaded rolling element and the raceway.

• **Static equivalent radial load of radial bearings is calculated as the following formula**

$\alpha = 0^\circ$ and roller bearings support only radial load

$$P_{or} = F_r$$

radial ball bearings and radial roller bearings with $\alpha \neq 0^\circ$

$$P_{or} = X_0 F_r + Y_0 F_a$$

$$P_{or} = F_r \quad \text{take the larger value}$$

• **Static equivalent axial load of thrust bearings is calculated as the following formula:**

thrust bearings with $\alpha = 90^\circ$

$$P_{oa} = F_a$$

thrust bearings with $\alpha \neq 90^\circ$

$$P_{oa} = 2.3 F_r \operatorname{tg} \alpha + F_a$$

Limit speed of rolling bearings

Rolling bearing limit speed is the speed value when bearing reaches the highest heat balance temperature under certain working conditions. Bearing limit speed relates to bearing type, structure design, dimensions, load, lubrication, tolerance class, cage, cooling and etc. The limit speeds listed in this catalogue are determined in grease and oil lubrication conditions. The applicable ranges are:

1. bearings, tolerance class 0
2. radial bearings support only radial load, thrust bearings support only axial load
3. bearing load $P \leq 0.1C$
4. rigid bearing housing and shaft
5. normal lubrication and cooling condition

When bearing load $P > 0.1C$ or under combined load, the allowance speed in actual situation will lower than the limit speed listed in the catalogue. At this time, it should be calculated as:

$$N = f_1 \cdot f_2 \cdot N_0$$

in which N bearing allowable speed in actual situation, r/min

N_0 bearing limit speed, r/min

f_1 load factor, see fig 2

f_2 load distribution factor, see fig 3

If bearing allowable speed can not meet the operation requirements, other methods will be adopted to improve bearing performance, e.g. changing lubrication method, improving cooling conditions, improving bearing accuracy, increasing bearing clearance properly, change to special bearing material and adopting special cage, etc.

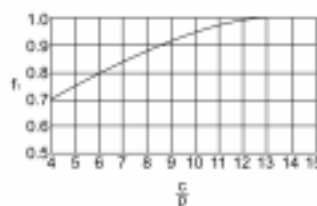

adjusted factor related to load conditions f_1

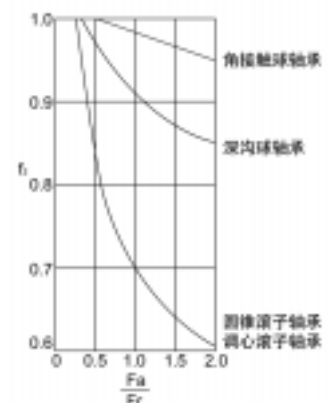

adjusted factor related to combined load conditions f_2

Bearing accuracy

Bearing accuracy and tolerance classes

Rolling bearings have dimensional accuracy and running accuracy.

- dimension tolerance (items related to the mounting of shaft and housing)
 - allowable deviation of ID, OD, width and mounting width
 - allowable deviation of roller sets inscribed circle diameter and encircle diameter
 - allowable limit of chamfer dimension
 - allowable deviation and allowance variation of taper bore
- running accuracy (items related to rotating element run-out)
 - allowance radial run-out and axial run-out of bearing inner rings and outer rings
 - allowance variation of thrust bearing raceway thickness

Table 9. Lists various bearing tolerance classes and the comparison of international standards

Table 9-29. List various bearing size accuracy and running accuracy

Table 9. Comparison of bearing tolerance classes of different countries

bearing type							
ISO	Radial ball bearings	Normal Class	Class 6X	Class 6	Class 5	Class 4	Class 2
	Thrust ball bearings	Normal Class	/	Class 6	Class 5	Class 4	/
DIN/BS/NF	Radial orThrust ball bearings	Normal Class	Class 6X	Class 6	Class 5	Class 4	Class 2
	Radial ball bearings	ABEC-1	/	ABEC-3	ABEC-5	ABEC-7	ABEC-9
ABMA/ANSI		RBEC-1	/	RBEC-3	RBEC-5	RBEC-7	RBEC-9
	Taper roller bearings	Class 4	/	Class 2	Class 3	Class 0	Class 00
JIS B	Deep groove ball bearings	Class 0	/	Class 6	Class 5	Class 4	Class 2
	Angular contact ballbearings	Class 0	/	Class 6	Class 5	Class 4	Class 2
	Sslf-aligning ball bearings	Class 0	/	/	/	/	/
JIS B	Cylindrical roller bearings	Class 0	/	Class 6	Class 5	Class 4	Class 2
	Machined roller bearings	Class 0	/	Class 6	Class 5	Class 4	/
	Taper roller bearings	Class 0	Class 6X	Class 6	Class 5	Class 4	/
GB		P0	P6X	P6	P5	P4	P2

ISO:International Organization for Standardization

ANSI:American National Standards Institute ,Inc

DIN: Deutsches Institute for Normung

JIS: Japanese Industrial Standards

BS: British Standards Institution

NF: Association Francaise de Normalisation

GB: Chinese National Standard

ABMA:American Bearing Manufactures Association

Table 10. Radial bearing (except taper roller bearings) inner ring, tolerance class 0

d mm		Δ_{dmp}		V _{dp} diameter series			V _{dmp}	K _{ia}	Δ_{Bs}			V _{BS}
over	to	up	down	7,8,9	0,1	2,3,4	max	max	all	normal	adjusted	max
				max			max	max	upper	lower		max
0.6	2.5	0	-8	10	8	6	6	6	0	-40	/	12
2.5	10	0	-8	10	8	6	6	6	0	-120	-250	15
10	18	0	-8	10	8	6	6	6	0	-120	-250	20
18	30	0	-10	13	10	8	8	8	0	-120	-250	20
30	50	0	-12	15	12	9	9	9	0	-120	-250	20
50	80	0	-15	19	19	11	11	11	0	-150	-380	25
80	120	0	-20	25	25	15	15	15	0	-200	-380	25
120	180	0	-25	31	31	19	19	30	0	-250	-500	30
180	250	0	-30	38	38	23	23	40	0	-300	-500	30
250	315	0	-35	44	44	26	26	50	0	-350	-500	35
315	400	0	-40	50	50	30	30	60	0	-400	-630	40
400	500	0	-45	56	56	34	34	65	0	-450	/	50
500	630	0	-50	63	63	38	38	70	0	-500	/	60
630	800	0	-75	/	/	/	/	80	0	-750	/	70
800	1000	0	-100	/	/	/	/	90	0	-1000	/	80

Table 11. Radial bearing (except taper roller bearings) outer ring, tolerance class 0

d mm		Δ_{dmp}		V _{dp} diameter series			V _{dmp}	K _{ia}	Δ_{BS}		V _{BS}
over	to	up	down	7,8,9	0,1	2,3,4	max	max	all	normal	max
				max			max	max	upper	lower	max
0.6	2.5	0	-8	10	8	10	6	15			
2.5	10	0	-8	10	8	10	6	15			
10	18	0	-8	12	9	12	7	15			
18	30	0	-10	14	11	16	8	20			
30	50	0	-12	16	13	20	10	25	equivalent to Δ_{BS} and V _{BS} of the same bearing inner ring		
50	80	0	-15	19	19	26	11	35			
80	120	0	-20	23	31	30	14	40			
120	180	0	-25	31	31	38	19	45			
180	250	0	-30	38	38	/	23	50			
250	315	0	-35	44	44	/	26	60			
315	400	0	-40	50	50	/	30	70			
400	500	0	-45	56	56	/	34	80			
500	630	0	-50	63	63	/	38	100			
630	800	0	-75	94	94	/	55	120			
800	1000	0	-100	125	125	/	75	140			

Table 12. Radial bearing (except taper roller bearings) inner ring, tolerance class 6

d mm		Δ_{dmp}		V_{dp} diameter series			V_{dmp}	K_{ia}	Δ_{BS}			V_{BS}
over	to	up	down	7,8,9	0,1	2,3,4	max	max	all	normal	adjusted	max
				max			max	max	upper	lower		max
0.6	2.5	0	-7	9	7	5	5	5	0	-40	/	12
2.5	10	0	-7	9	7	5	5	6	0	-120	-250	15
10	18	0	-7	9	7	5	5	7	0	-120	-250	20
18	30	0	-8	10	8	6	6	8	0	-120	-250	20
30	50	0	-10	13	10	8	8	10	0	-120	-250	20
50	80	0	-12	15	15	9	9	10	0	-150	-380	25
80	120	0	-15	19	19	11	11	13	0	-200	-380	25
120	180	0	-18	23	23	14	14	18	0	-250	-500	30
180	250	0	-22	28	28	17	17	20	0	-300	-500	30
250	315	0	-25	31	31	19	19	25	0	-350	-500	35
315	400	0	-30	38	38	23	23	30	0	-400	-630	40
400	500	0	-35	44	44	26	26	35	0	-450	/	45
500	630	0	-40	50	50	30	30	40	0	-500	/	50

Table 13. Radial bearing (except taper roller bearings) outer ring, tolerance class 6

d mm		Δ_{dmp}		V_{dp} diameter series			V_{dmp}	K_{ia}	Δ_{BS}		V_{BS}
over	to	up	down	7,8,9	0,1	2,3,4	max	max	all	normal	max
				max			max	max	upper	lower	max
0.6	2.5	0	-7	9	7	5	5	8			
2.5	10	0	-7	9	7	5	5	8			
10	18	0	-8	10	8	6	6	9			
18	30	0	-9	11	9	7	7	10			
30	50	0	-11	14	11	8	8	13	equivalent to Δ_{BS} and V_{BS} of the same bearing inner ring		
50	80	0	-13	16	16	10	10	18			
80	120	0	-15	19	19	11	11	20			
120	180	0	-18	23	23	14	14	23			
180	250	0	-20	25	25	15	15	25			
250	315	0	-25	31	31	19	19	30			
315	400	0	-28	35	35	21	21	35			
400	500	0	-33	41	41	25	25	40			
500	630	0	-38	48	48	29	29	50			
630	800	0	-45	56	56	34	34	60			
800	1000	0	-60	75	75	45	45	70			

Table 14. Radial bearing (except taper roller bearings) inner ring, tolerance class 5

d mm		Δ_{dmp}		V _{dip} diameter series		V _{dmp}	K _{ia}	S _d	S _{ia}	Δ_{BS}			V _{BS}
over	to	up	down	7,8,9	0,1,2,3,4	max	max	max	max	all	normal	adjusted	max
0.6	2.5	0	-5	5	4	3	4	7	7	0	-40	-250	5
2.5	10	0	-5	5	4	3	4	7	7	0	-40	-250	5
10	18	0	-5	5	4	3	4	7	7	0	-80	-250	5
18	30	0	-6	6	5	3	4	8	8	0	-120	-250	5
30	50	0	-8	8	6	4	5	8	8	0	-120	-250	5
50	80	0	-9	9	7	5	5	8	8	0	-150	-250	6
80	120	0	-10	10	8	5	6	9	9	0	-200	-380	7
120	180	0	-13	13	10	7	8	10	10	0	-250	-380	8
180	250	0	-15	15	12	8	10	11	13	0	-300	-500	10
250	315	0	-18	18	14	9	13	13	15	0	-350	-500	13
315	400	0	-23	23	18	12	15	15	20	0	-400	-630	15

Table 15. Radial bearing (except taper roller bearings) outer ring, tolerance class 5

d mm		Δ_{dmp}		V _{dip} diameter series		V _{dmp}	K _{ia}	S _D	S _{ea}	Δ_{BS}		V _{BS}
over	to	up	down	7,8,9	0,1,2,3,4	max	max	max	max	all	normal	max
0.6	2.5	0	-5	5	4	3	5	8	8			5
2.5	10	0	-5	5	4	3	5	8	8			5
10	18	0	-6	6	5	3	6	8	8			5
18	30	0	-7	7	5	4	7	8	8			5
30	50	0	-9	9	7	5	8	8	10	equivalent to Δ_{BS} and V _{BS} of the same bearing inner ring		6
50	80	0	-10	10	8	5	10	9	11			8
80	120	0	-11	11	8	6	11	10	13			8
120	180	0	-13	13	10	7	13	10	14			8
180	250	0	-15	15	11	8	15	11	15			10
250	315	0	-18	18	14	9	18	13	18			11
315	400	0	-20	20	15	10	20	13	20			13
400	500	0	-23	23	17	12	23	15	23			15
500	630	0	-28	28	21	14	25	18	25			18
630	800	0	-35	35	26	18	30	20	30			20

Bearing internal clearance

Bearing internal clearance refers to the movement amount of the inner (outer) ring when the other outer (inner) ring is fixed. Radial movement amount is called radial internal clearance, while axial moving amount is called axial internal clearance, see fig 4.

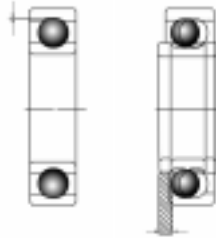

Fig 4. Radial clearance and axial clearance

How to select bearing internal clearance

Mounting clearance, the theoretical clearance minus bearing ring expansion amount or shrink amount caused by the interference fit when mounting on the shaft or in the housing.

Effective clearance, mounting clearance minus plus bearing dimension variation caused by internal temperature difference.

$$S = S_0 - (S_f + S_{t1} + S_{t2})$$

Clearance decrease amount S_f caused by fit:

$$\text{For hollow shaft, } S_{fi} = \Delta_{\text{deff}} d/D_i (1 - d_o^2/d^2)(1 - d_o^2/D_i^2) \quad S_{fo} = \Delta_{\text{deff}} D_e/D (1 - D^2/D_h^2)(1 - D_e^2/D_h^2)$$

$$\text{For solid shaft, } S_{fi} = \Delta_{\text{deff}} d/D_i \quad S_{fo} = \Delta_{\text{deff}} D_e/D$$

$$\text{Clearance decrease amount } S_{t1} \text{ caused by inner and outer ring temperature difference: } S_{t1} = \alpha (D_i \cdot t_i - D_e \cdot t_e)$$

$$\text{Clearance decrease amount } S_{t2} \text{ caused by rolling elements temperature rise: } S_{t2} = 2 \alpha \cdot D_r \cdot t_r$$

which:	S	working clearance, mm
	S_0	theoretical clearance, mm
	S_f	clearance decrease amount caused by fit
	S_{fi}	inner ring raceway diameter expansion amount, mm
	S_{fo}	outer ring raceway diameter shrink amount, mm
	S_{t1}	clearance decrease amount caused by inner and outer ring temperature difference, mm
	S_{t2}	clearance decrease amount caused by rolling elements temperature rise, mm
	Δ_{deff}	inner ring effective interference, mm
	d	bearing nominal inner diameter, mm
	d_o	hollow shaft inner diameter, mm
	D_i	inner ring raceway diameter, mm
	Δ_{Deff}	outer ring effective interference, mm
	D_h	housing outside diameter, mm
	D_e	outer ring raceway diameter, mm
	D	bearing nominal outer diameter, mm
	α	liner expansion coefficient of bearing steel, $(12.5 \times 10^{-6}) / ^\circ\text{C}$
	D_r	mean diameter of rolling elements, mm
	t_i	inner ring temperature rise, $^\circ\text{C}$
	t_e	outer ring temperature rise, $^\circ\text{C}$
	t_r	rolling element temperature rise, $^\circ\text{C}$

Bearing internal clearances before mounting list in table 16-18

Table 16. radial internal clearance of deep groove ball bearings with cylindrical bore

bearing nominal ID		clearance									
over	to	C2		C0		C3		C4		C5	
		min	max	min	max	min	max	min	max	min	max
2.5	6	0	7	2	13	8	23	14	29	20	37
6	10	0	7	2	13	8	23	14	29	20	37
10	18	0	9	3	18	11	25	18	33	25	45
18	24	1	10	5	20	13	28	20	36	28	48
24	30	1	11	5	20	13	28	23	41	30	53
30	40	1	11	6	20	15	33	28	46	40	64
40	50	1	11	6	23	18	36	30	51	45	73
50	65	1	15	8	28	23	43	38	61	55	90
65	80	1	15	10	30	25	51	46	71	65	105
80	100	1	18	12	36	30	58	53	84	75	120
100	120	2	20	15	41	36	66	61	97	90	140
120	140	2	23	18	48	41	81	71	114	105	160
140	160	2	23	18	53	46	91	81	130	120	180
160	180	2	25	20	61	53	102	91	147	135	200
180	200	2	30	25	71	63	117	107	163	150	230
200	225	2	35	25	85	75	140	125	195	175	265
225	250	2	40	30	95	85	160	145	225	205	300
250	280	2	45	35	105	90	170	155	245	225	340
280	315	2	55	40	115	100	190	175	270	245	370
315	355	3	60	45	125	110	210	195	300	275	410
355	444	3	70	55	145	130	240	225	340	315	460

Table 17. radial internal clearance of double-row angular contact ball bearings

bearing nominal ID		clearance					
over	to	CD2		CDN		CD3	
		min	max	min	max	min	max
2.5	10	0	7	2	10	8	18
10	18	0	7	2	11	9	19
18	24	0	8	2	11	10	21
24	30	0	8	2	13	10	23
30	40	0	9	3	14	11	24
40	50	0	10	4	16	13	27
50	65	0	11	6	20	15	30
65	80	0	12	7	22	18	33
80	100	0	12	8	24	22	38
100	120	0	13	9	25	24	42
120	140	0	15	10	26	25	44
140	160	0	16	11	28	26	46
160	180	0	17	12	30	27	47
180	200	0	18	14	32	28	48

Table 18. Radial internal clearance of deep groove ball bearings for electric motors

bearing nominal ID		clearance CD2	
over	to	min	max
10	18	4	11
18	30	5	12
30	50	9	17
50	80	12	22
80	120	18	30
120	160	24	38

Lubrication

◇ Lubrication purpose

The purpose of rolling bearing lubrication is to reduce bearing internal friction and wear, prevent burning. Lubrication functions include:

- **Reduce friction and wear**

Prevent metal contacts and reduce frictional wear at the inter-contact positions between bearing rings, rolling elements and cage.

- **Extend fatigue life**

Good lubrication on the contact surfaces will extend bearing fatigue life; otherwise, lower oil viscosity and uneven-distributed lubricating oil film will shorten bearing life.

- **Take away frictional heat , cooling**

Circulating lubrication takes away the heat produced by friction or from outside to prevent bearing over-heat and avoid oil deterioration.

- **Prevent external substance from entering bearing and prevent rust or corrosion.**

◇ Grease lubrication

Amount of grease fill lubricating

Generally speaking, the grease fill amount is about 1/3-1/2 of the effective space of bearings. If too much grease is used , the grease is easy to deteriorate or soften because of stirring heat.

Lubricating grease replenishment and replacement

Lubricating grease has a limit service life. Its lubricating function becomes weaker during operation and more wear debris produced. Therefore the grease has to be replenished or replaced at certain intervals in most supporting systems applications. The replenishment period is related to bearing structure, size, rotation speed, and temperature and environmental conditions.

Lubricating grease mixture

Different brands of lubricating grease can't be mixed together. Mixture of greases with different thickness is harmful to the structure and viscosity of the grease. Mixture of greases with different base oils will cause two-element-liquids and affect continuous lubrication. Therefore, it is generally advised not to mix various greases together. If a different brand grease must be used, it is highly recommended to thoroughly remove the original grease before adding the new grease.

◇ Oil lubrication

Lubricating oil type

- **Oil bath lubrication** oil bath lubrication is used for low and medium speed bearings. Part of the bearing is immersed in the oil tank. The lubrication oil is brought up by the rotating bearing and then back to the oil tank. When bearing is in a static condition, keep the oil surface at the center of the lowest rolling element.

- **Oil drop lubrication** oil drop lubrication is used for higher speed small bearings. The bearing is lubricated by oil drops through a visible oil cup. Normally, several drops per minute.

- **Splash lubrication** Bearings is lubricated with splashed oil produced by rotating gears or simple blades mounted on the shaft. It is widely used in automobiles, differential gear devices and gear boxes in machine tools.

- **Spray lubrication** an oil pump is used to spray high-pressure oil onto the bearing surface through a nozzle. The oil passes through the bearing inside and runs into an oil tank. For high-speed bearings, when the bearing is running, the rolling elements and cage are also rotating in a rather high speed. The surrounding air forms an air flow in this circumstance, which will lead to larger resistance, it is difficult to input lubricating oil into the bearing by usual lubrication methods and spray lubrication is the best choice at this time. The nozzle position should point to the gap between the inner ring and cage.

- **Oil mist lubrication** oil mist is made by mixing filtered dry and clean pressured air and lubricating oil and is sprayed into the bearing. The air flow inside bearing housing will cool the bearing. It is suitable for high speed and high temperature bearing lubrication.

Viscosity is an important index of lubricating oil and the most important factor in lubricating oil selection. Oil viscosity is closely related to temperature and decreases when temperature rises. To ensure efficient lubricating oil film on the contact surface between rolling elements and the raceway, oil viscosity must be kept at a certain level during operation. Lower viscosity will form inefficient oil film and lead to abnormal bearing wear and reduce bearing life in the end. While higher viscosity will lead to over heating and serious energy loss because of the viscous resistance.

In general, low viscosity oil is for high speed applications. High viscosity oil is for heavy load applications. The replenishment interval mainly depends on running conditions and oil amount. As to oil bath lubrication, replace the oil once a year if the running temperature is lower than 50°C and in good environment with little dust. Higher temperatures require more frequent oil replacement.

rolling bearing fit

To prevent skidding between bearing inner ring and shaft, bearing outer ring and housing bore, it is very important to choose and keep correct bearing fit. In order to choose a proper fit, all factors like bearing load and load type, bearing type and other design or performance requirements must be considered simultaneously.

◆ How to choose rolling bearing fit bearings with cylindrical bore

When choosing bearing fit, the following factors must be taken into account.

load type

• Fixed load

It is a combined radial load acting on bearing rings, which is sustained at local raceway areas and is transferred to the corresponding local areas of the shaft and housing. Bearing rings under fixed load usually have loose fit.

• Rotary load

It is a combined radial load acting on bearing rings, which rotates in raceway circular direction and sustained at any raceway positions. Bearing rings under rotary load should have transition or interference fit with the shaft or housing bore. If clearance fit is adopted, temperature will rise sharply and the bearing will be destroyed in a short time. The interference amount depends on running conditions and basic principle is that there is no "creep" on the fit surface of bearing rings with the shaft or housing bore.

• Oscillatory load

It is a combined radial load acting on bearing rings, which makes relative oscillatory movement in certain raceway areas and sustained at certain raceway positions. It may be an impact load with variable directions and values. For bearings under oscillatory load, especially under heavy load, the inner and outer rings must have interference fit. If inner ring rotates, normally has the fit as under rotary load. But sometimes the outer ring must move freely in bearing housing, another case is a looser fit than under rotary load when bearing outer ring is under lighter load.

Load

Under the radial load component, bearing rings are pressed and have a loose fit surface as a result. Especially when under heavy rotary load, skidding is easy to occur. Therefore, for heavy load applications, normally choose tighter fit than under light load and normal load applications. Heavier load needs larger interference fit amount.

Equivalent dynamic radial load is divided as "light" "normal" and "heavy" load, see table 19

Table 19. bearing load type

P_r	ball bearing	roller bearing (except taper roller bearing)	taper roller bearing
light load	$P_r \leq 0.07C_r$	$P_r \leq 0.08C_r$	$P_r \leq 0.13C_r$
normal load	$0.07C_r < P_r \leq 0.15C_r$	$0.08C_r < P_r \leq 0.18C_r$	$0.13C_r < P_r \leq 0.26C_r$
heavy load	$0.15C_r < P_r$	$0.18C_r < P_r$	$0.26C_r < P_r$

In which, C_r is the basic dynamic radial load rating

Bearing size

Larger bearing size needs larger interference amount in interference fit and larger clearance in clearance fit.

Bearing clearance

Interference fit will result in smaller bearing clearance. Bearing clearance must be checked after mounting to see if it is meet the operation requirement and correctly choose bearing fit and bearing clearance.

Working temperature

When bearings are running, bearing ring temperature is usually higher than its adjacent parts. The inner ring may have loose contact with the shaft because of heat expansion. The outer ring may affect axial movement of the bearing because of the heat expansion. Temperature difference and heat transfer direction must be taken into account when choosing bearing fit.

Bearing rotation accuracy

When higher rotation accuracy and operation stability is required, in order to eliminate the effect of elastic deformation and vibration, clearance fit must be avoided.

Easy mounting and dismounting

In many applications, clearance fits are adopted for easy mounting and dismounting. According to running condition, if interference fit must be applied, usually have separable bearings or taper bore bearings for the purpose of easy mounting and dismounting.

• **Floating end bearing displacement**

Floating end bearings require a certain axial movable amount of one ring. Generally the ring under fixed load is mounted with clearance fit. If cylindrical roller bearings with no inner ring (outer ring) rib or needle roller bearings are mounted at the floating end, both inner ring and outer ring can be mounted with interference fit.

• **Bearings with taper bore**

Bearings with taper bore have the character of easy mounting and dismounting, which can be mounted directly onto the tapered shaft neck or onto cylindrical shaft by way of a middle sleeve with tapered external surface. Fit requirements for bearing outer ring and the housing bore is the same as bearings with cylindrical bore.

◇ **Bearing fit with shaft and housing**

Bearing fit with shaft adopts basic bore system, bearing fit with housing adopts basic shaft system. Shaft fit tolerance band of radial bearings is chosen from table 20. Shaft fit tolerance band of thrust bearings is chosen from table 21. Housing bore tolerance band of radial bearings is chosen from table 22. Housing bore tolerance band of thrust bearings is chosen from table 23.

Table 20. shaft tolerance band for mounting radial bearings

inner ring working condition		examples	deep groove ball bearing aligning ball bearing angular contact ball bearing	cylindrical roller bearing taper roller bearing	spherical roller bearing	tolerance band
rotating condition	load		bearing nominal ID d mm			
inner ring rotates or oscillates related to load direction	light load	electric meters, machine tool spindles, ventilators, conveyers	$d \leq 18$	/	/	h5
			$18 < d \leq 100$	$d \leq 40$	$d \leq 40$	j6*
			$100 < d \leq 200$	$40 < d \leq 140$	$40 < d \leq 140$	k6*
	normal load	motors, turbines, pumps, diesel engine, gear box	/	$140 < d \leq 200$	$140 < d \leq 200$	m6*
			$d \leq 18$	/	/	j5 js5
			$18 < d \leq 100$	$d \leq 40$	$d \leq 40$	k5*
			$100 < d \leq 140$	$40 < d \leq 100$	$40 < d \leq 65$	m5*
			$140 < d \leq 200$	$100 < d \leq 140$	$65 < d \leq 100$	m6
			$200 < d \leq 280$	$140 < d \leq 200$	$100 < d \leq 140$	n6
	heavy load	railroad vehicles, shaft box in electric buses, rolling mills, destroyers	/	$200 < d \leq 400$	$140 < d \leq 280$	p6
			/	/	$280 < d \leq 500$	r6
			/	$50 < d \leq 140$	$50 < d \leq 100$	n6***
static inner ring related to load direction	all loads	inner ring movable on the shaft	various static wheels on the shaft	all sizes	f6*	
		inner ring not movable on the shaft	tension pulleys, string pulleys	all sizes	g6*	
	pure axial load	all applications				j6 js6
			all loads			
all loads	shaft boxes of train and electric bus		all dimensions mounted on the withdraw sleeve			h8****
	normal machinery and transmission shaft		all dimensions mounted on adapter sleeve			h9****

note: * as to higher accuracy requirement applications, choose j6,k6 instead of j5,k5... etc.

** taper roller bearings and angular contact ball bearings fits have little effect to clearance, may choose k6,m6 instead of k5,m5.

*** heavy-loaded bearings choose clearance group O.

**** as to higher accuracy or speed requirements applications, choose h7 instead of h8.

Table 21. Shaft tolerance band for mounting thrust bearings

housing washer working condition		thrust ball bearing and thrust roller bearing		thrust spherical roller bearing	tolerance band	
		bearing nominal ID d mm				
		all dimension		all dimension		j6 or js6
radial and axial combined load	static inner ring related to load direction	/		d ≤ 250	j5	
	inner ring rotates or oscillates related to load direction	/		250 < d	js6	
	inner ring rotates or oscillates related to load direction	/		d ≤ 200	k6	
		/		200 < d ≤ 400	m6	
		/		400 < d	n6	

Note: 1> if smaller interference required, you may choose j6, k6, m6 instead of k6, m6, n6

Table 22. tolerance band of the housing hole when mounting radial bearings

outer ring working condition				examples	ball bearing	roller bearing
rotation condition	load	axial displacement limit	others			
static outer ring related to load direction	light, normal and heavy load impact load	free axial movement	shaft in high temperature application split-housing axial movable	dry column general machinery, shaft boxes in railroad vehicles shaft boxes in railroad vehicles	G7* H7 J7, Js7	
outer ring oscillates related to load direction	light, normal load normal, heavy load strong impact load	axial movement	integral housing	motors, pumps, crank spindles motors, pumps, crank spindles traction motor	K7 M7	
outer ring rotates related to load direction	light load normal and heavy load strong impact load	no axial movement	thin section, integral housing	intension pulley hubs with ball bearings hubs with cylindrical roller bearings	J7 J7, M7 /	K7 / N7, P7

note: 1) choose parallel tolerance from left to right as the dimension increases. When higher rotation accuracy is required, you may choose one class higher tolerance.
2) *unsuitable for split housing

Table 23. tolerance band of the housing hole when mounting thrust bearings

housing washer working condition		bearing type	tolerance band	
pure axial load		thrust ball bearing	H8	
		thrust cylindrical, needle roller bearing	H7	
radial and axial combined load	housing washer relative to load direction static	thrust aligning roller bearing	H7	
	housing washer relative to load direction rotation or oscillation		K7	normal load
			M7	heavy load

deep groove ball bearings

Miniature deep groove ball bearing

Series 6..

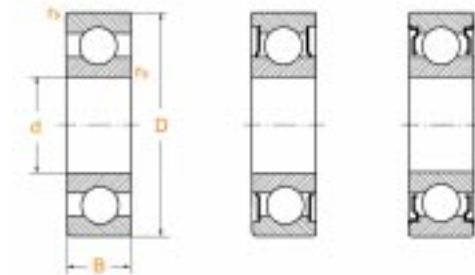

	2RS	ZZ		2RS	ZZ
--	-----	----	--	-----	----

Designation	Dimensions				Basic radial load(kN)		Speed limit		Weight kg
	d mm	D	B	r _s min.	dyn. C _r	stat. C _{0r}	grease r/min	oil r/min	
624	4	13	5	0.2	1.29	0.49	38 000	45 000	0.0032
624 ZZ		13	5	0.2	1.29	0.49	38 000		
634	4	16	5	0.3	1.73	0.67	34 000	40 000	0.0051
634 ZZ		16	5	0.3	1.73	0.67	34 000		
625	5	16	5	0.3	1.32	0.44	34 000	40 000	0.0048
625 ZZ		16	5	0.3	1.32	0.44	34 000		
625 2RS		16	5	0.3	1.32	0.44	22 000		
635	5	19	6	0.3	2.55	1.04	32 000	38 000	0.0080
635 ZZ		19	6	0.3	2.55	1.04	32 000		
626	6	19	6	0.3	2.55	1.04	32 000	38 000	0.0081
626 ZZ		19	6	0.3	2.55	1.04	32 000		
626 2RS		19	6	0.3	2.55	1.04	22 000		
607	7	19	6	0.3	2.55	1.04	32 000	38 000	0.0080
607 ZZ		19	6	0.3	2.55	1.04	32 000		
607 2RS		19	6	0.3	2.55	1.04	22 000		
627	7	22	7	0.3	3.25	1.37	30 000	36 000	0.0130
627 ZZ		22	7	0.3	3.25	1.37	30 000		
627 2RS		22	7	0.3	3.25	1.37	20 000		
608	8	22	7	0.3	3.25	1.37	30 000	36 000	0.0120
608 ZZ		22	7	0.3	3.25	1.37	30 000		
608 2RS		22	7	0.3	3.25	1.37	20 000		
609	9	24	7	0.3	3.65	1.63	30 000	36 000	0.0140
609 ZZ		24	7	0.3	3.65	1.63	30 000		
609 2RS		24	7	0.3	3.65	1.63	20 000		
629	9	26	8	0.3	4.55	1.96	28 000	34 000	0.0200
629 ZZ		26	8	0.3	4.55	1.96	28 000		
629 2RS		26	8	0.3	4.55	1.96	18 000		

deep groove ball bearings

Thin section deep groove ball bearing

Series 618/619..

Normal deep groove ball bearing

Series 60/62/63..

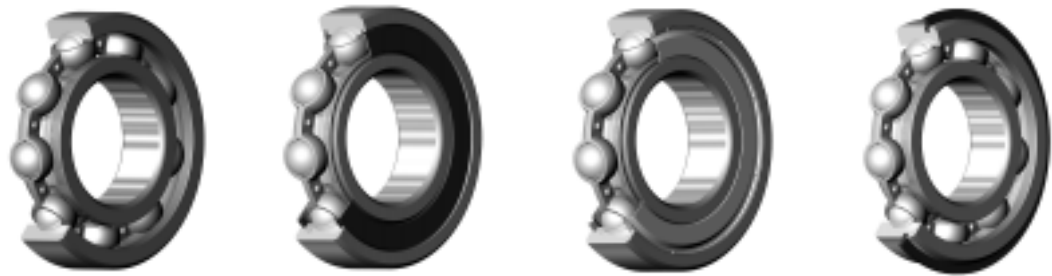

Designation	Dimensions				Basic radial load(kN)		Speed limit		Weight
	d mm	D	B	r _s min.	dyn. C _r	stat. C _{0r}	grease r/min	oil r/min	kg
61800		19	5	0.3	1.72	0.84	34 000	40 000	0.005
61800 ZZ	10	19	5	0.3	1.72	0.84	32 000		
61800 2RS		19	5	0.3	1.72	0.84	18 000		
61900		22	6	0.3	2.7	1.27	30 000	36 000	0.019
61900 ZZ	10	22	6	0.3	2.7	1.27	30 000		
61900 2RS		22	6	0.3	2.7	1.27	18 000		
6000		26	8	0.3	4.58	1.97	28 000	34 000	0.0190
6000 ZZ	10	26	8	0.3	4.58	1.97	28 000		
6000 2RS		26	8	0.3	4.58	1.97	17 000		
6200		30	9	0.6	5.11	12.39	26 000	38 000	0.0320
6200 ZZ	10	30	9	0.6	5.11	12.39	26 000		
6200 2RS		30	9	0.6	5.11	12.39	17 000		
6300		35	11	0.6	7.65	3.47	20 000	26 000	0.0532
6300 ZZ	10	35	11	0.6	7.65	3.47	20 000		
6300 2RS		35	11	0.6	7.65	3.47	14 000		
61801		21	5	0.3	1.92	1.04	30 000	36 000	0.006
61801 ZZ	12	21	5	0.3	1.92	1.04	30 000		
61801 2RS		21	5	0.3	1.92	1.04	18 000		
61901		24	6	0.3	2.89	1.46	28 000	34 000	0.011
61901 ZZ	12	24	6	0.3	2.89	1.46	28 000		
61901 2RS		24	6	0.6	2.89	1.46	18 000		
6001		28	8	0.3	5.11	2.39	26 000	32 000	0.021
6001 ZZ	12	28	8	0.3	5.11	2.39	26 000		
6001 2RS		28	8	0.3	5.11	2.39	17 000		
6201		32	10	0.6	6.82	3.06	22 000	28 000	0.035
6201 ZZ	12	32	10	0.6	6.82	3.06	22 000		
6201 2RS		32	10	0.6	6.82	3.06	15 000		
6301		37	12	1	9.72	5.09	19 000	24 000	0.0574
6301 ZZ	12	37	12	1	9.72	5.09	19 000		
6301 2RS		37	12	1	9.72	5.09	12 000		

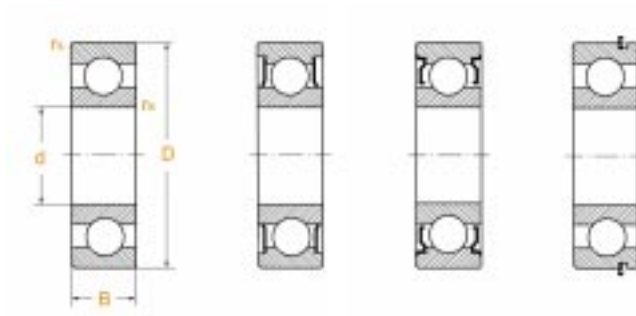

2RS	ZZ	NR
-----	----	----

Designation	Dimensions				Basic radial load(kN)		Speed limit		Weight kg	
	snap ring	d mm	D	B	r _s min.	dyn. C _r	stat. C _{0r}	grease r/min		oil r/min
61802			24	5	0.3	2.07	1.26	28 000	34 000	0.007
61802 ZZ	15		24	5	0.3	2.07	1.26	28 000		
61802 2RS			24	5	0.3	2.07	1.26	16 000		
61902			28	7	0.3	4.35	2.26	26 000	32 000	0.016
61902 ZZ	15		28	7	0.3	4.35	2.26	26 000		
61902 2RS			28	7	0.3	4.35	2.26	15 000		
6002			32	9	0.3	5.59	2.84	22 000	28 000	0.030
6002 ZZ	15		32	9	0.3	5.59	2.84	22 000		
6002 2RS			32	9	0.3	5.59	2.84	14 000		
6202			35	11	0.6	7.64	3.72	19 000	24 000	0.045
6202 ZZ	15		35	11	0.6	7.64	3.72	19 000		
6202 2RS			35	11	0.6	7.64	3.72	13 000		
6302			42	13	1	11.44	5.43	17 000	20 000	0.0804
6302 ZZ	15		42	13	1	11.44	5.43	17 000		
6302 2RS			42	13	1	11.44	5.43	11 000		
61803			26	5	0.3	2.63	1.57	26 000	32 000	0.008
61803 ZZ	17		26	5	0.3	2.63	1.57	26 000		
61803 2RS			26	5	0.3	2.63	1.57	15 000		
61903			30	7	0.3	4.6	2.55	24 000	30 000	0.018
61903 ZZ	17		30	7	0.3	4.6	2.55	24 000		
61903 2RS			30	7	0.3	4.6	2.55	14 000		
6003			35	10	0.3	6	3.25	20 000	26 000	0.040
6003 ZZ	17		35	10	0.3	6	3.25	20 000		
6003 2RS			35	10	0.3	6	3.25	12 000		
6203			40	12	0.6	9.57	4.79	17 000	20 000	0.064
6203 ZZ	17		40	12	0.6	9.57	4.79	17 000		
6203 2RS			40	12	0.6	9.57	4.79	11 000		
6203 NR	SP40		40	12	0.6	9.57	4.79	17 000	20 000	
6303			47	14	1	13.58	6.58	16 000	19 000	0.1096
6303 ZZ	17		47	14	1	13.58	6.58	16 000		
6303 2RS			47	14	1	13.58	6.58	11 000		

deep groove ball bearings

Thin section deep groove ball bearing

Series 618/619..

Normal deep groove ball bearing

Series 60/62/63..

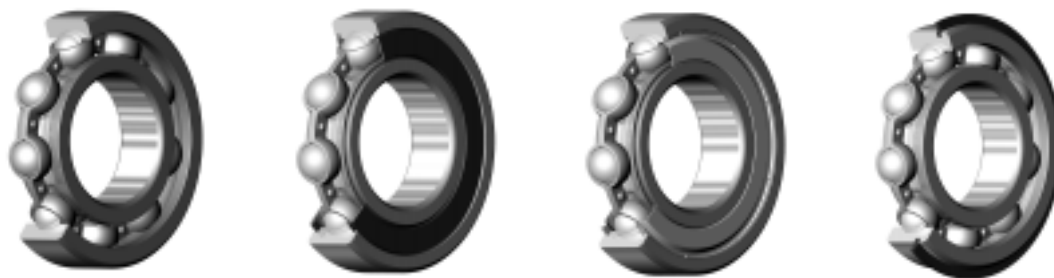

2RS

ZZ

NR

Designation	Dimensions				Basic radial load(kN)		Speed limit		Weight kg	
	snap ring	d mm	D	B	r _s min.	dyn. C _r	stat. C _{0r}	grease r/min		oil r/min
61804			32	7	0.3	4.00	2.47	19 500	23 500	0.019
61804 ZZ		20	32	7	0.3	4.00	2.47	19 500		
61804 2RS			32	7	0.3	4.00	2.47	11 500		
61904			37	9	0.3	6.40	3.70	17 500	20 500	0.036
61904 ZZ		20	37	9	0.3	6.40	3.70	17 500		
61904 2RS			37	9	0.3	6.40	3.70	10 000		
6004			42	12	0.6	9.38	5.03	17 000	20 000	0.068
6004 ZZ		20	42	12	0.6	9.38	5.03	17 000		
6004 2RS			42	12	0.6	9.38	5.03	11 000		
6204			47	14	1	12.84	6.65	15 000	18 000	0.103
6204 ZZ		20	47	14	1	12.84	6.65	15 000		
6204 2RS			47	14	1	12.84	6.65	10 000		
6204 NR	SP47		47	14	1	12.84	6.65	15 000		
6304			52	15	1.1	15.94	7.88	13 000	16 000	0.1417
6304 ZZ		20	52	15	1.1	15.94	7.88	13 000		
6304 2RS			52	15	1.1	15.94	7.88	8 000		
6304 NR	SP52		52	15	1.1	15.94	7.88	13 000		
61805			37	7	0.3	4.3	2.95	17 000	20 000	0.022
61805 ZZ		25	37	7	0.3	4.3	2.95	17 000		
61805 2RZ			37	7	0.3	4.3	2.95	9 800		
61905			42	9	0.3	7.05	4.55	15 000	18 000	0.042
61905 ZZ		25	42	9	0.3	7.05	4.55	15 000		
61905 2RS			42	9	0.3	7.05	4.55	9 000		
6005			47	12	0.6	10.06	5.85	15 000	18 000	0.079
6005 ZZ		25	47	12	0.6	10.06	5.85	15 000		
6005 2RS			47	12	0.6	10.06	5.85	9 000		
6205			52	15	1	14.02	7.88	12 000	15 000	0.127
6205 ZZ		25	52	15	1	14.02	7.88	12 000		
6205 2RS			52	15	1	14.02	7.88	8 000		
6205 NR	SP52		52	15	1	14.02	7.88	12 000		
6305			62	17	1.1	22.38	11.69	11 000	14 000	0.2193
6305 ZZ		25	62	17	1.1	22.38	11.69	11 000		
6305 2RS			62	17	1.1	22.38	11.69	7 500		
6305 NR	SP62		62	17	1.1	22.38	11.69	11 000		

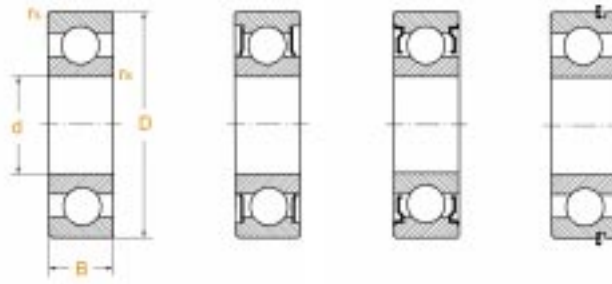

2RS

ZZ

NR

Designation	snap ring	Dimensions			Basic radial load(kN)		Speed limit		Weight kg	
		d mm	D	B	r _s min.	dyn. C _r	stat. C _{0r}	grease r/min		oil r/min
61806		30	42	7	0.3	4.5	3.45	14 500	17 500	0.026
61806 ZZ			42	7	0.3	4.5	3.45	14 500		
61806 2RS			42	7	0.3	4.5	3.45	8 400		
61906			47	9	0.3	7.25	5.00	13 500	16 000	0.048
61906 ZZ			47	9	0.3	7.25	5.00	13 500		
61906 2RS			47	9	0.3	7.25	5.00	8 100		
6006			55	13	1	13.23	8.30	12 000	15 000	0.113
6006 ZZ			55	13	1	13.23	8.30	12 000		
6006 2RS			55	13	1	13.23	8.30	7 000		
6006 NR	SP55		55	13	1	13.23	8.30	12 000		
6206			62	16	1	19.46	11.31	10 000	13 000	0.202
6206 ZZ			62	16	1	19.46	11.31	10 000		
6206 2RS			62	16	1	19.46	11.31	7 500		
6206 NR	SP62		62	16	1	19.46	11.31	10 000	10 000	
6306			72	19	1.1	27.00	15.19	9 000	11 000	0.3498
6306 ZZ			72	19	1.1	27.00	15.19	9 000		
6306 2RS			72	19	1.1	27.00	15.19	6 000		
6306 NR	SP72		72	19	1.1	27.00	15.19	9 000		
61807		35	47	7	0.3	4.75	3.90	13 000	15 500	0.029
61807 ZZ			47	7	0.3	4.75	3.90	13 000		
61807 2RS			47	7	0.3	4.75	3.90	7 300		
61907			55	10	0.6	10.60	7.25	11 500	14 000	0.074
61907 ZZ			55	10	0.6	10.60	7.25	11 500		
61907-2RS			55	10	0.6	10.60	7.25	7 000		
6007			62	14	1	16.21	10.42	10 000	13 000	0.149
6007 ZZ			62	14	1	16.21	10.42	10 000		0.164
6007 2RS			62	14	1	16.21	10.42	7 000		
6007 NR	SP62		62	14	1	16.21	10.42	10 000		
6207			72	17	1.1	25.67	15.30	9 000	11 000	0.287
6207 ZZ			72	17	1.1	25.67	15.30	9 000		
6207 2RS			72	17	1.1	25.67	15.30	6 000		
6207 NR	SP72		72	17	1.1	25.67	15.30	9 000		
6307			80	21	1.5	33.36	19.21	8 500	10 000	0.4542
6307 ZZ			80	21	1.5	33.36	19.21	8 500		
6307 2RS			80	21	1.5	33.36	19.21	5 600		
6307 NR	SP80		80	21	1.5	33.36	19.21	8 500		

deep groove ball bearings

Thin section deep groove ball bearing

Series 618/619..

Normal deep groove ball bearing

Series 60/62/63..

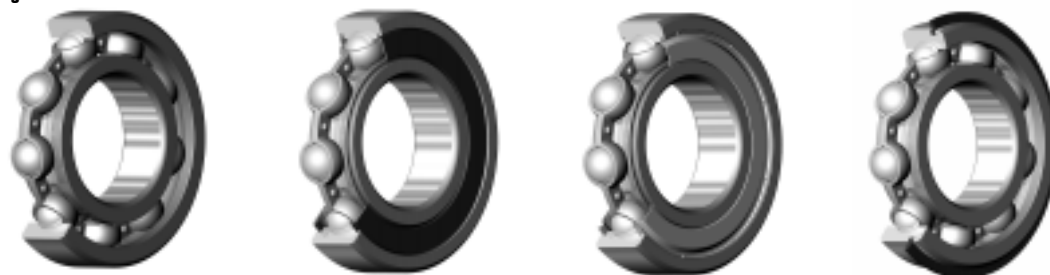

2RS

ZZ

NR

Designation	snap ring	Dimensions			r_s mm	Basic radial load(kN)		Speed limit		Weight kg
		d mm	D	B		dyn. C _r	stat. C _{0r}	grease r/min	oil r/min	
61808			52	7	0.3	4.90	4.35	11 500	14 000	0.033
61808 ZZ		40	52	7	0.3	4.90	4.35	11 500		
61808 2RS			52	7	0.3	4.90	4.35	6 500		
61908			62	12	0.6	13.70	10.00	10 000	12 000	0.110
61908 ZZ		40	62	12	0.6	13.70	10.00	10 000		
61908 2RS			62	12	0.6	13.70	10.00	6 100		
6008			68	15	1	17.03	11.70	9 500	12 000	0.185
6008 ZZ		40	68	15	1	17.03	11.70	9 500		
6008 2RS			68	15	1	17.03	11.70	6 000		
6008 NR	SP68		68	15	1	17.03	11.70	9 500		
6208			80	18	1.1	29.52	18.14	8 500	10 000	0.367
6208 ZZ		40	80	18	1.1	29.52	18.14	8 500		
6208 2RS			80	18	1.1	29.52	18.14	5 600		
6208 NR	SP80		80	18	1.1	29.52	18.14	8 500		
6308			90	23	1.5	40.75	24.01	7 500	9 000	0.6394
6308 ZZ		40	90	23	1.5	40.75	24.01	7 500		
6308 2RS			90	23	1.5	40.75	24.01	5 000		
6308 NR	SP90		90	23	1.5	40.75	24.01	7 500		
61809			58	7	0.3	5.35	5.25	10 500	12 500	0.040
61809 ZZ		45	58	7	0.3	5.35	5.25	10 500		
61809 2RS			58	7	0.3	5.35	5.25	5 800		
61909			68	12	0.6	14.10	10.90	9 100	11 000	0.128
61909 ZZ		45	68	12	0.6	14.10	10.90	9 100		
61909 2RS			68	12	0.6	14.10	10.90	5 000		
6009			75	16	1	21.09	14.77	9 000	11 000	0.231
6009 ZZ		45	75	16	1	21.09	14.77	9 000		
6009 2RS			75	16	1	21.09	14.77	5 600		
6009 NR	SP75		75	16	1	21.09	14.77	9 000		
6209			85	19	1.1	31.67	20.68	7 500	9 000	0.416
6209 ZZ		45	85	19	1.1	31.67	20.68	7 500		
6209 2RS			85	19	1.1	31.67	20.68	5 300		
6209 NR	SP85		85	19	1.1	31.67	20.68	7 500	9 500	
6309			100	25	1.5	52.86	31.83	6 700	8 000	0.8363
6309 ZZ		45	100	25	1.5	52.86	31.83	6 700		
6309 2RS			100	25	1.5	52.86	31.83	4 500		
6309 NR	SP100		100	25	1.5	52.86	31.83	6 700		

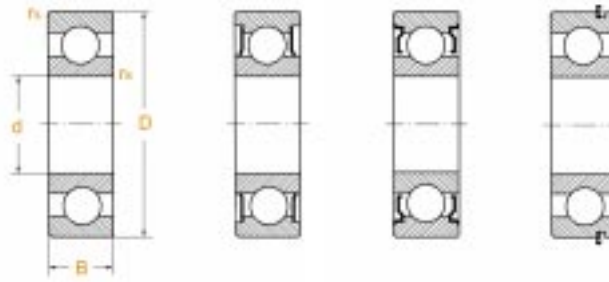

2RS	ZZ	NR
-----	----	----

Designation	snap ring	Dimensions			r _s min.	Basic radial load(kN)		Speed limit		Weight kg
		d mm	D	B		dyn. C _r	stat. C _{0r}	grease r/min	oil r/min	
61810			65	7	0.3	6.40	6.20	9 300	11 000	0.052
61810 ZZ		50	65	7	0.3	6.40	6.20	9 300		
61810 2RS			65	7	0.3	6.40	6.20	5 100		
61910			72	12	0.6	14.50	11.70	7 900	9 500	0.132
61910 ZZ		50	72	12	0.6	14.50	11.70	7 900		
61910 2RS			72	12	0.6	14.50	11.70	4 500		
6010			80	16	1	22.02	16.25	8 500	10 000	0.250
6010 ZZ		50	80	16	1	22.02	16.25	8 500		
6010 2RS			80	16	1	22.02	16.25	5 300		
6010 NR	SP80		80	16	1	22.02	16.25	8 500		
6210			90	20	1.1	35.07	23.18	7 000	8 500	0.462
6210 ZZ		50	90	20	1.1	35.07	23.18	7 000		
6210 2RS			90	20	1.1	35.07	23.18	4 500		
6210 NR	SP90		90	20	1.1	35.07	23.18	7 000		
6310			110	27	2	61.86	37.94	6 000	7 000	1.0822
6310 ZZ		50	110	27	2	61.86	37.94	6 000		
6310 2RS			110	27	2	61.86	37.94	4 000		
6310 NR	SP110		110	27	2	61.86	37.94	6 000		
61811			72	9	0.3	9.10	7.60	8 400	10 000	0.083
61811 ZZ		55	72	9	0.3	9.10	7.60	8 400		
61811 2RS			72	9	0.3	9.10	7.60	4 700		
61911			80	13	1.0	16.0	11.5	7 700	9 200	0.180
61911 ZZ		55	80	13	1.0	16.0	11.5	7 700		
61911 2RS			80	13	1.0	16.0	11.5	5 000		
6011			90	18	1.1	30.26	21.43	7 500	9 000	0.362
6011 ZZ		55	90	18	1.1	30.26	21.43	7 500		
6011 2RS			90	18	1.1	30.26	21.43	4 500		
6011 NR	SP90		90	18	1.1	30.26	21.43	7 500		
6211			100	21	1.5	43.38	29.22	6 300	7 500	0.602
6211 ZZ		55	100	21	1.5	43.38	29.22	6 300		
6211 2RS			100	21	1.5	43.38	29.22	4 000		
6211 NR	SP100		100	21	1.5	43.38	29.22	6 300		
6311			120	29	2	71.57	44.76	5 300	6 300	1.3676
6311 ZZ		55	120	29	2	71.57	44.76	5 300		
6311 2RS			120	29	2	71.57	44.76	3 600		
6311 NR	SP120		120	29	2	71.57	44.76	5 300		

deep groove ball bearings

Normal deep groove ball bearing
Series 60/62/63..

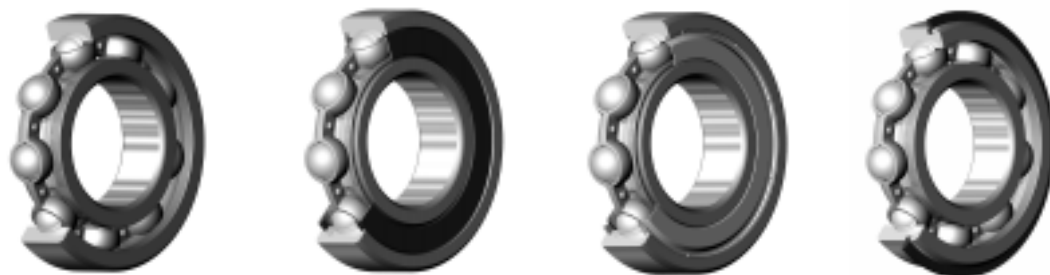

Designation	snap ring	Dimensions			r_s min.	Basic radial load(kN)		Speed limit		Weight kg
		d mm	D	B		dyn. C_r	stat. C_{0r}	grease r/min	oil r/min	
6012			95	18	1.1	31.66	24.22	6 700	8 000	0.385
6012 ZZ		60	95	18	1.1	31.66	24.22	6 700		
6012 2RS			95	18	1.1	31.66	24.22	4 300		
6012 NR	SP95		95	18	1.1	31.66	24.22	7 000	8 000	
6212			110	22	1.5	47.76	32.93	6 000	7 000	0.789
6212 ZZ		60	110	22	1.5	47.76	32.93	6 000		
6212 2RS			110	22	1.5	47.76	32.93	4 000		
6212 NR	SP110		110	22	1.5	47.76	32.93	6 000		
6312			130	31	2.1	81.75	51.85	5 000	6 000	1.7095
6312 ZZ		60	130	31	2.1	81.75	51.85	5 000		
6312 2RS			130	31	2.1	81.75	51.85	3 400		1.720
6312 NR	SP130		130	31	2.1	81.75	51.85	5 000		
6013			100	18	1.1	32.06	24.89	6 300	7 500	0.408
6013 ZZ		65	100	18	1.1	32.06	24.89	6 300		
6013 2RS			100	18	1.1	32.06	24.89	4 000		
6013 NR	SP100		100	18	1.1	32.06	24.89	6 300		
6213			120	23	1.5	57.21	40	5 300	6 300	0.990
6213 ZZ		65	120	23	1.5	57.21	40	5 300		
6213 2RS			120	23	1.5	57.21	40	3 600		
6213 NR	SP120		120	23	1.5	57.21	40	5 300		
6313			140	33	2.1	93.87	60.44	4 800	5 600	2.097
6313 ZZ		65	140	33	2.1	93.87	60.44	4 800		
6313 2RS			140	33	2.1	93.87	60.44	3 000		
6313 NR	SP140		140	33	2.1	93.87	60.44	4 800		

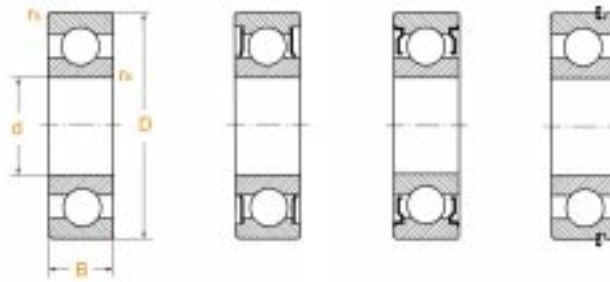

2RS	ZZ	NR
-----	----	----

Designation	snap ring	Dimensions			Basic radial load(kN)		Speed limit		Weight kg	
		d mm	D	B	r _s min.	dyn. C _r	stat. C _{0r}	grease r/min		oil r/min
6014			110	20	1.1	38.59	30.43	6 000	7 000	0.573
6014 ZZ		70	110	20	1.1	38.59	30.43	6 000		
6014 2RS			110	20	1.1	38.59	30.43	3 600		
6014 NR	SP110		110	20	1.1	38.59	30.43	6 000		
6214			125	24	1.5	60.83	45.03	5 000	6 000	1.084
6214 ZZ		70	125	24	1.5	60.83	45.03	5 000		
6214 2RS			125	24	1.5	60.83	45.03	3 400		
6214 NR	SP125		125	24	1.5	60.83	45.03	5 000		
6314			150	35	2.1	104.13	68.04	4 500	5 300	2.543
6314 ZZ		70	150	35	2.1	104.13	68.04	4 500		
6314 2RS			150	35	2.1	104.13	68.04	2 800		
6314 NR	SP150		150	35	2.1	104.13	68.04	4 500		
6015			115	20	1.1	40.18	33.18	5 600	6 700	0.603
6015 ZZ		75	115	20	1.1	40.18	33.18	5 600		
6015 2RS			115	20	1.1	40.18	33.18	3 400		
6015 NR	SP115		115	20	1.1	40.18	33.18	5 600		
6215			130	25	1.5	66.11	49.50	4 800	5 600	1.171
6215 ZZ		75	130	25	1.5	66.11	49.50	4 800		
6215 2RS			130	25	1.5	66.11	49.50	3 200		
6215 NR	SP130		130	25	1.5	66.11	49.50	4 800		
6315			160	37	2.1	113.42	76.97	4 000	4 800	3.096
6315 ZZ		75	160	37	2.1	113.42	76.97	4 000		
6315 2RS			160	37	2.1	113.42	76.97	2 800		
6315 NR	SP160		160	37	2.1	113.42	76.97	4 000		

deep groove ball bearings

Normal deep groove ball bearing

Series 60/62/63..

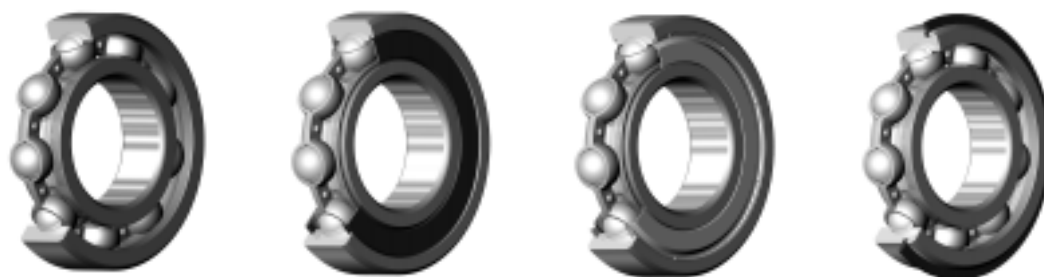

	2RS	ZZ	NR
--	-----	----	----

Designation	snap ring	Dimensions			r_s min.	Basic radial load(kN)		Speed limit		Weight kg
		d mm	D	B		dyn. C _r	stat. C _{0r}	grease r/min	oil r/min	
6016			125	22	1.1	47.6	39.8	5 300	6 300	0.854
6016 ZZ		80	125	22	1.1	47.6	39.8	5 300		
6016 2RS			125	22	1.1	47.6	39.8	3 600		
6016 NR	SP125		125	22	1.1	47.6	39.8	5 300		
6216			140	26	2	72.7	53	4 500	5 300	1.400
6216 ZZ		80	140	26	2	72.7	53	4 500		
6216 2RS			140	26	2	72.7	53	3 000		
6216 NR	SP140		140	26	2	72.7	53	4 500		
6316			170	39	2.1	123	86.5	3 800	4 500	3.590
6316 ZZ		80	170	39	2.1	123	86.5	3 800		
6316 2RS			170	39	2.1	123	86.5	3 800		
6316 NR	SP170		170	39	2.1	123	86.5	3 800		
6017			130	22	1.1	49.5	43.1	5 000	6 000	0.890
6017 ZZ		85	130	22	1.1	49.5	43.1	5 000		
6017 2RS			130	22	1.1	49.5	43.1	3 400		
6017 NR	SP130		130	22	1.1	49.5	43.1	5 000		
6217			150	28	2	84	61.9	4 300	5 000	1.790
6217 ZZ		85	150	28	2	84	61.9	4 300		
6217 2RS			150	28	2	84	61.9	2 800		
6217 NR	SP150		150	28	2	84	61.9	4 300		
6317			180	41	3	133	96.6	3 600	4 300	4.230
6317 ZZ		85	180	41	3	133	96.6	3 600		
6317 2RS			180	41	3	133	96.6	3 600		
6317 NR	SP180		180	41	3	133	96.6	3 600		
6018			140	24	1.5	58.2	49.7	4 500	5 300	1.020
6018 ZZ		90	140	24	1.5	58.2	49.7	4 500		
6018 2RS			140	24	1.5	58.2	49.7	3 000		
6018 NR	SP140		140	24	1.5	58.2	49.7	4 500	5 600	
6218			160	30	2	96	71.5	3 800	4 500	2.150
6218 ZZ		90	160	30	2	96	71.5	3 800		
6218 2RS			160	30	2	96	71.5	3 800		
6218 NR	SP160		160	30	2	96	71.5	3 800		
6318			190	43	3	143	107	3 400	4 000	4.910
6318 ZZ		90	190	43	3	143	107	3 400		
6318 2RS			190	43	3	143	107	3 400		
6318 NR	SP190		190	43	3	143	107	3 400		

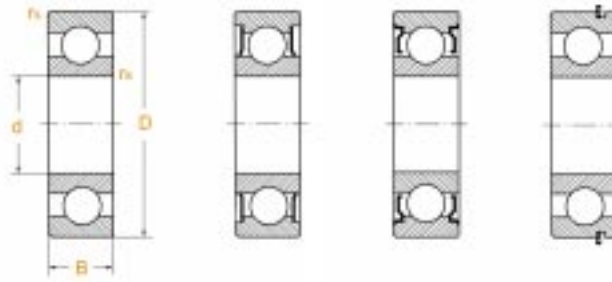

2RS	ZZ	NR
-----	----	----

Designation	snap ring	Dimensions			r_s min.	Basic radial load(kN)		Speed limit		Weight kg
		d mm	D	B		dyn. C _r	stat. C _{0r}	grease r/min	oil r/min	
6019			145	24	1.5	60.5	53.6	4 300	5 000	1.080
6019 ZZ		95	145	24	1.5	60.5	53.6	4 300		
6019 2RS			145	24	1.5	60.5	53.6	2 800		
6019 NR	SP145		145	24	1.5	60.5	53.6	4 300		
6219			170	32	2.1	109	81.9	3 600	4 300	2.620
6219 ZZ		95	170	32	2.1	109	81.9	3 600		
6219 2RS			170	32	2.1	109	81.9	3 600		
6219 NR	SP170		170	32	2.1	109	81.9	3 600		
6319			200	45	3	153	118	3 200	3 800	5.670
6319 ZZ		95	200	45	3	153	118	3 200		
6319 2RS			200	45	3	153	118	3 200		
6020			150	24	1.5	60.5	54	4 300	5 000	0.910
6020 ZZ		100	150	24	1.5	60.5	54	4 300		
6020 2RS			150	24	1.5	60.5	54	2 800		
6020 NR	SP150		150	24	1.5	60.5	54	4 300		
6220			180	34	2.1	124	93	3 400	4 000	3.140
6220 ZZ		100	180	34	2.1	124	93	3 400		
6220 2RS			180	34	2.1	124	93	3 400		
6320			215	47	3	173	140	3 000	3 600	7.000
6320 ZZ		100	215	47	3	173	140	3 000		
6320 2RS			215	47	3	173	140	3 000		

double row angular contact ball bearings

Series 32/33..



ZZ

2RS

Designation	Dimensions					Basic radial load(kN)		Speed limit	Weight
	d mm	D	B	r _s min.	a	dyn. C _r	stat. C _{0r}	grease r/min	kg
3200		30	14.0	0.6	18	7.8	4.6	16 000	0.051
3200 ZZ	10	30	14.0	0.6	18	7.8	4.6	16 000	
3200 2RS		30	14.0	0.6	18	7.8	4.6	16 000	
3201		32	15.9	0.6	20	10.6	5.9	15 000	0.058
3201 ZZ	12	32	15.9	0.6	20	10.6	5.9	15 000	
3201 2RS		32	15.9	0.6	20	10.6	5.9	15 000	
3202		35	15.9	0.6	22	11.8	7.1	14 000	0.066
3202 ZZ	15	35	15.9	0.6	22	11.8	7.1	14 000	
3202 2RS		35	15.9	0.6	22	11.8	7.1	14 000	
3302		42	19	1.0	26	17.7	10.3	10 000	0.130
3302 ZZ	15	42	19	1.0	26	17.7	10.3	10 000	
3302 2RS		42	19	1.0	26	17.7	10.3	10 000	
3203		40	17.5	0.6	25	14.8	9.1	11 000	0.096
3203 ZZ	17	40	17.5	0.6	25	14.8	9.1	11 000	
3203 2RS		40	17.5	0.6	25	14.8	9.1	11 000	
3303		47	22.2	1.0	29	21.1	12.5	9 500	0.180
3303 ZZ	17	47	22.2	1.0	29	21.1	12.5	9 500	
3303 2RS		47	22.2	1.0	29	21.1	12.5	9 500	
3204		47	20.6	1.0	30	19.9	12.6	10 000	0.160
3204 ZZ	20	47	20.6	1.0	30	19.9	12.6	10 000	
3204 2RS		47	20.6	1.0	30	19.9	12.6	10 000	
3304		52	22.2	1.1	32	24.5	15.8	9 000	0.220
3304 ZZ	20	52	22.2	1.1	32	24.5	15.8	9 000	
3304 2RS		52	22.2	1.1	32	24.5	15.8	9 000	
3205		52	20.6	1.0	33	21.6	14.9	9 000	0.180
3205 ZZ	25	52	20.6	1.0	33	21.6	14.9	9 000	
3205 2RS		52	20.6	1.0	33	21.6	14.9	9 000	
3305		62	25.4	1.1	38	32.5	21.6	7 900	0.350
3305 ZZ	25	62	25.4	1.1	38	32.5	21.6	7 900	
3305 2RS		62	25.4	1.1	38	32.5	21.6	7 900	

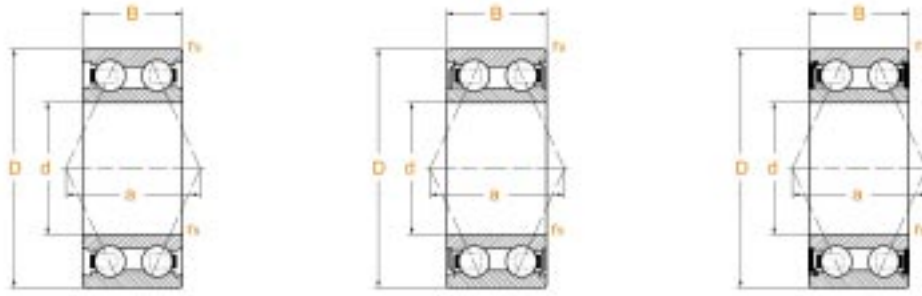

ZZ

2RS

Designation	Dimensions					Basic radial load(kN)		Speed limit	Weight kg
	d mm	D	B	r _s min.	a	dyn. C _r	stat. C _{0r}	grease r/min	
3206		62	23.8	1.0	38	30.0	21.4	7 100	0.290
3206 ZZ	30	62	23.8	1.0	38	30.0	21.4	7 100	
3206 2RS		62	23.8	1.0	38	30.0	21.4	7 100	
3306		72	30.2	1.1	44	45.5	31.5	6 200	0.530
3306 ZZ	30	72	30.2	1.1	44	45.5	31.5	6 200	
3306 2RS		72	30.2	1.1	44	45.5	31.5	6 200	
3207		72	27.0	1.1	45	39.5	29	5 600	0.440
3207 ZZ	35	72	27.0	1.1	45	39.5	29	5 600	
3207 2RS		72	27.0	1.1	45	39.5	29	5 600	
3307		80	34.9	1.5	49	56	39.5	5 100	0.730
3307 ZZ	35	80	34.9	1.5	49	56	39.5	5 100	
3307 2RS		80	34.9	1.5	49	56	39.5	5 100	
3208		80	30.2	1.1	49	50	37.5	5 000	0.580
3208 ZZ	40	80	30.2	1.1	49	50	37.5	5 000	
3208 2RS		80	30.2	1.1	49	50	37.5	5 000	
3308		90	36.5	1.5	56	69	49.5	4 700	0.950
3308 ZZ	40	90	36.5	1.5	56	69	49.5	4 700	
3308 2RS		90	36.5	1.5	56	69	49.5	4 700	
3209		85	30.2	1.1	52	50	38.5	4 800	0.630
3209-ZZ	45	85	30.2	1.1	52	50	38.5	4 800	
3209-2RS		85	30.2	1.1	52	50	38.5	4 800	
3309		100	39.7	1.5	64	82	60	4 000	1.400
3309 ZZ	45	100	39.7	1.5	64	82	60	4 000	
3309-2RS		100	39.7	1.5	64	82	60	4 000	
3210		90	30.2	1.1	56	54	44	4 000	0.740
3210 ZZ	50	90	30.2	1.1	56	54	44	4 000	
3210 2RS		90	30.2	1.1	56	54	44	4 000	
3310		110	44.4	2.0	73	96	72	3 200	1.950
3310 ZZ	50	110	44.4	2.0	73	96	72	3 200	
3310 2RS		110	44.4	2.0	73	96	72	3 200	

inner rings

Series IR

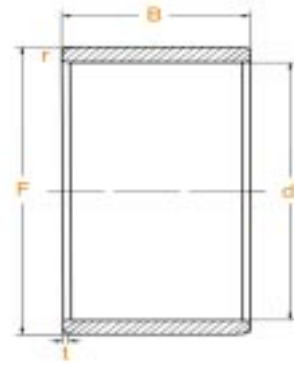

Shaft diameter	Designation	Dimensions				Chamfer t	Weight ≈ kg
		d mm	F	B	r min.		
5	IR	5x8x12			0,3	1	0.0028
	IR	5x8x16			0,3	1	0.0037
6	IR	6x9x12			0,3	1	0.003
	IR	6x9x16			0,3	1	0.0043
	IR ¹⁾	6x10x10			0,3	1	0.0037
	IR ²⁾	6x10x12			0,3	/	0.0046
7	IR	7x10x10,5			0,3	1	0.0031
	IR	7x10x12			0,3	1	0.0036
	IR	7x10x16			0,3	1	0.0049
8	IR ¹⁾	8x12x10			0,3	1	0.0048
	IR	8x12x12,5			0,3	1	0.005
	IR ²⁾	8x12x12			0,3	/	0.0056
	IR	8x12x12,5			0,3	1	0.0059
9	IR	9x12x12			0,3	1	0.0044
	IR	9x12x16			0,3	1	0.006
10	IR	10x13x12,5			0,3	1	0.0052
	IR ¹⁾	10x14x12			0,3	1	0.0073
	IR	10x14x13			0,3	1	0.0074
10	IR ²⁾	10x14x14			0,3	1	0.0081
	IR	10x14x16			0,3	1	0.0092
	IR	10x14x20			0,3	1	0.0115
12	IR	12x15x12			0,3	1	0.0057
	IR	12x15x12,5			0,3	1	0.0061
	IR	12x15x16			0,3	1	0.0076
12	IR	12x15x16,5			0,3	/	0.0081
	IR	12x15x22,5			0,3	1	0.00109
	IR ¹⁾	12x16x12			0,3	1	0.0079

Shaft diameter	Designation	Dimensions				Chamfer t	Weight ≈ kg
		d mm	F	B	r min.		
12	IR	12x16x13			0,3	1	0.0085
	IR ²⁾	12x16x14			0,3	/	0.0094
12	IR	12x16x16			0,3	1	0.0107
	IR	12x16x20			0,3	1	0.0135
	IR	12x16x22			0,3	1	0.0149
14	IR	14x17x17			0,3	1	0.0095
15	IR	15x18x16			0,3	1	0.0094
	IR	15x18x16,5			0,3	1	0.0098
	IR	15x19x16			0,3	1	0.0129
	IR	15x19x20			0,3	1	0.0163
15	IR ¹⁾	15x20x12			0,3	1,5	0.0122
	IR	15x20x13			0,3	1,5	0.0135
	IR ²⁾	15x20x14			0,3	/	0.0146
17	IR	15x20x23			0,3	1,5	0.0244
	IR	17x20x16			0,3	1	0.0106
17	IR	17x20x16,5			0,3	1	0.0111
	IR	17x20x20			0,3	1	0.0135
17	IR	17x20x20,5			0,3	1	0.0138
	IR	17x20x30,5			0,3	1	0.0206
17	IR	17x21x16			0,3	1	0.015
	IR	17x21x20			0,3	1	0.018
17	IR	17x22x13			0,3	1,5	0.0149
	IR ²⁾	17x22x14			0,3	1	0.0164
	IR	17x22x16			0,3	1,5	0.0184
	IR	17x22x23			0,3	1,5	0.0271
17	IR	17x24x20			0,6	1,5	0.0338

1) with lubrication hole

2) with lubrication hole but no assembly chamfer on the outside surface

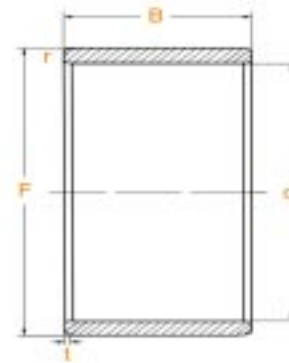

Shaft diameter	Designation	Dimensions				Chamfer t	Weight ≈ kg
		d mm	F mm	B mm	r min.		
20	IR	20x24x16			0,3	1	0.015
	IR	20x24x20			0,3	1	0.0213
	IR ¹⁾	20x25x16			0,3	1.5	0.024
20	IR	20x25x16,5			0,3	1.5	0.025
	IR ²⁾	20x25x17			0,3	/	0.0242
	IR	20x25x18			0,3	1.5	0.0275
	IR	20x25x20,5			0,3	1.5	0.0274
20	IR	20x25x26,5			0,3	1.5	0.038
	IR	20x25x30			0,3	1.5	0.0404
	IR	20x25x38,5			0,3	1.5	0.0525
	IR	20x28x20			0,3	2	0.0452
22	IR	22x26x16			0,3	1	0.0182
	IR	22x26x20			0,3	1	0.023
	IR	22x28x17			0,3	1.8	0.0295
22	IR	22x28x20			0,3	1.8	0.035
	IR	22x28x20,5			0,3	1.8	0.036
	IR	22x28x30			0,3	1.8	0.0545
25	IR	25x29x20			0,3	1	0.0259
	IR	25x29x30			0,3	1	0.0393
	IR ¹⁾	25x30x16			0,3	1.5	0.0257
25	IR	25x30x17			0,3	1.5	0.0274
	IR ²⁾	25x30x18			0,3	/	0.0298
	IR	25x30x20			0,3	1.5	0.0328
25	IR	25x30x20,5			0,3	1.5	0.0334
	IR	25x30x26,5			0,3	1.5	0.046
	IR	25x30x30			0,3	1.5	0.053
25	IR	25x30x32			0,3	1.5	0.056
	IR	25x30x38,5			0,3	1.5	0.0645
	IR	25x32x22			0,6	1.8	0.0525

Shaft diameter	Designation	Dimensions				Chamfer t	Weight ≈ kg
		d mm	F mm	B mm	r min.		
28	IR	28x32x17			0,3	1	0.0245
	IR	28x32x20			0,3	1	0.0285
	IR	28x32x30			0,3	1	0.0435
30	IR	30x35x13			0,3	1.5	0.025
	IR	30x35x16			0,3	1.5	0.034
	IR	30x35x17			0,3	1.5	0.036
30	IR ²⁾	30x35x18			0,3	/	0.0351
	IR	30x35x20			0,3	1.5	0.039
	IR	30x35x20,5			0,3	1.5	0.0397
	IR	30x35x26			0,3	1.5	0.0504
30	IR	30x35x30			0,3	1.5	0.0585
	IR	30x37x18			0,6	1.8	0.050
	IR	30x37x22			0,6	1.8	0.0616
	IR ¹⁾	30x38x20			0,6	2	0.077
32	IR	32x37x20			0,3	1.5	0.042
	IR	32x37x30			0,3	1.5	0.062
	IR	32x40x20			0,6	2	0.068
32	IR	32x40x36			0,6	2	0.0124
	IR	32x40x36			0,6	2	0.0124
33	IR	33x37x13			0,3	1	0.0219

1) with lubrication hole

2) with lubrication hole but no assembly chamfer on the outside surface

inner rings

Series IR

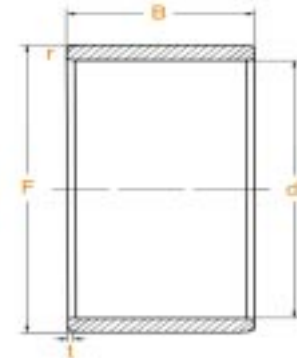

Shaft diameter	Designation	Dimensions				Chamfer t	Weight ≈ kg
		d mm	F	B	r min.		
35	IR	35x40x17			0,3	2	0.0378
	IR	35x40x20			0,3	2	0.0442
	IR	35x40x20,5			0,3	2	0.0461
35	IR	35x40x30			0,3	/	0.0671
	IR ¹⁾	35x42x20			0,6	1.8	0.0639
	IR ²⁾	35x42x21			0,6	/	0.068
35	IR ²⁾	35x42x23			0,6	/	0.0747
	IR	35x42x36			0,6	2	0.117
	IR	35x43x22			0,6	/	0.082
38	IR	38x43x20			0,3	1.8	0.0481
	IR	38x43x30			0,3	/	0.0736
40	IR	40x45x17			0,3	2	0.0425
	IR	40x45x20			0,3	2	0.0508
	IR	40x45x20,5			0,3	2	0.0518
40	IR	40x45x30			0,3	2	0.084
	IR	40x48x22			0,6	2	0.0916
	IR ²⁾	40x48x23			0,6	/	0.0975
40	IR	40x48x40			0,6	2	0.170
	IR ¹⁾	40x50x20			1	0.8	0.106
	IR	40x50x22			1	2	0.118
42	IR	42x47x20			0,3	2	0.0528
	IR	42x47x30			0,3	2	0.081

Shaft diameter	Designation	Dimensions				Chamfer t	Weight ≈ kg
		d mm	F	B	r min.		
45	IR	45x50x25			0,6	2	0.0708
	IR	45x50x25,5			0,3	/	0.0751
	IR	45x50x35			0,6	2	0.101
	IR	45x52x22			0,6	2	0.089
45	IR ²⁾	45x52x23			0,6	/	0.0939
	IR	45x52x40			0,6	2	0.164
	IR ¹⁾	45x55x20			1	2	0.117
	IR	45x55x22			1	2	0.129
50	IR ¹⁾	50x55x20			0,6	2	0.0625
	IR	50x55x25			0,6	2	0.078
	IR	50x55x35			0,6	2	0.112
50	IR	50x58x22			0,6	2	0.115
	IR ²⁾	50x58x23			0,6	/	0.119
	IR	50x58x40			0,6	2	0.208
50	IR ¹⁾	50x60x20			1	2	0.128
	IR	50x60x25			1	2	0.162
	IR	50x60x28			1,1	2	0.181
55	IR	55x60x25			0,6	2.2	0.0855
	IR	55x60x35			0,6	2	0.121
	IR	55x63x25			1	2	0.141
55	IR	55x63x45			1	2.2	0.256
	IR	55x65x28			1,1	2.2	0.198
60	IR	60x68x25			1	2.2	0.152
	IR	60x68x35			0,6	2.2	0.213
	IR	60x68x45			1	2.2	0.276
60	IR	60x70x25			1	2.2	0.195
	IR	60x70x28			1,1	2.2	0.215

1) with lubrication hole

2) with lubrication hole but no assembly chamfer on the outside surface

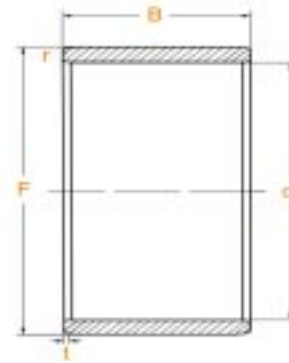

Shaft diameter	Designation	Dimensions				Chamfer	Weight
		d mm	F	B	r min.	t	≈ kg
65	IR	65x72x25			1	1.8	0.141
	IR	65x72x45			1	1.8	0.259
	IR	65x73x25			1	2	0.164
65	IR	65x73x35			1	2	0.231
	IR	65x75x28			1,1	2.5	0.229
70	IR	70x80x25			1	2.5	0.221
	IR	70x80x30			1	2.5	0.267
	IR	70x80x35			1	2.5	0.312
	IR	70x80x54			1	2.5	0.488
75	IR	75x85x25			1	2.5	0.238
	IR	75x85x30			1	2.5	0.287
	IR	75x85x35			1	2.5	0.336
	IR	75x85x54			1	2.5	0.520
80	IR	80x90x25			1	2.5	0.253
	IR	80x90x30			1	2.5	0.304
	IR	80x90x35			1	2.5	0.355
	IR	80x90x54			1	2.5	0.556

Shaft diameter	Designation	Dimensions				Chamfer	Weight
		d mm	F	B	r min.	t	≈ kg
85	IR	85x95x26			1	2.5	0.277
	IR	85x95x36			1	2.5	0.388
	IR	85x100x35			1,1	2.5	0.582
	IR	85x100x63			1,1	2.5	1.054
90	IR	90x100x26			1	2.5	0.294
	IR	90x100x30			1	2.5	0.340
	IR	90x100x36			1	2.5	0.406
90	IR	90x105x35			1,1	2.5	0.610
	IR	90x105x63			1,1	2.5	1.110
95	IR	95x105x26			1	2.5	0.313
	IR	95x105x36			1	2.5	0.431
	IR	95x110x35			1,1	2.5	0.657
	IR	95x110x63			1,1	/	1.170
100	IR	100x110x30			1,1	2.5	0.350
	IR	100x110x40			1,1	2.5	0.505
	IR	100x115x40			1,1	2.5	0.797
110	IR	110x120x30			1	2.5	0.409
	IR	110x125x40			1,1	2.5	0.840

inner rings

Series IRZ

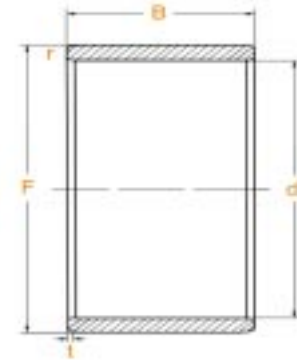

Designation	Dimensions d inch	F	B	r min.	Chamfer	Weight
					t	≈ kg
*IRZ 060908		14.288 (9/16)	12.95	0.6	/	0.013
IRZ 061012	9.525 (3/8)	15.875 (5/8)	19.30	0.6	1	0.019
IRZ 061016		15.875 (5/8)	25.65	0.6	1	0.025
IRZ 081210		19.050 (3/4)	16.13	1	/	0.020
*IRZ 081212	12.700 (1/2)	19.050 (3/4)	19.30	1	/	0.024
*IRZ 081216		19.050 (3/4)	25.65	1	/	0.032
*IRZ 101406		22.225 (7/8)	9.78	1	/	0.014
*IRZ 101408	15.875 (5/8)	22.225 (7/8)	12.95	1	/	0.018
*IRZ 101412		22.225 (7/8)	19.30	1	/	0.027
*IRZ 101416		22.225 (7/8)	25.65	1	/	0.036
*IRZ 121612	19.050 (3/4)	25.400 (1)	19.30	1	/	0.034
*IRZ 121616		25.400 (1)	25.65	1	/	0.045
*IRZ 141808		28.575 (1 1/8)	12.95	1	/	0.027
*IRZ 141812	22.225 (7/8)	28.575 (1 1/8)	19.30	1	/	0.040
*IRZ 141816		28.575 (1 1/8)	25.65	1	/	0.052
*IRZ 141820		28.575 (1 1/8)	32.00	1	/	0.066
*IRZ 162012		31.750 (1 1/4)	19.30	1	/	0.039
*IRZ 162016	25.400 (1)	31.750 (1 1/4)	25.65	1	/	0.052
*IRZ 162020		31.750 (1 1/4)	32.00	1	/	0.065
*IRZ 182208		34.925 (1 3/8)	19.30	1	/	0.032
*IRZ 182216	25.575 (1 1/8)	34.925 (1 3/8)	25.65	1	/	0.063
*IRZ 182220		34.925 (1 3/8)	32.00	1	/	0.079
*IRZ 202416	31.750 (1 1/4)	38.100 (1 1/2)	25.65	1.5	/	0.075
*IRZ 202420		38.100 (1 1/2)	32.00	1.5	/	0.094
IRZ 212616	33.338 (1 5/16)	41.275 (1 5/8)	25.65	1.5	2	0.093
IRZ 212620		41.275 (1 5/8)	32.00	1.5	2	0.116
IRZ 222610		41.275 (1 5/8)	16.13	1.5	2	0.073
IRZ 222816	34.925 (1 3/8)	44.450 (1 3/4)	25.65	1.5	2	0.117
IRZ 222820		44.450 (1 3/4)	32.00	1.5	2	0.146

1) with lubrication hole

2) with lubrication hole but no assembly chamfer on the outside surface

* ID and OD have light chamfer

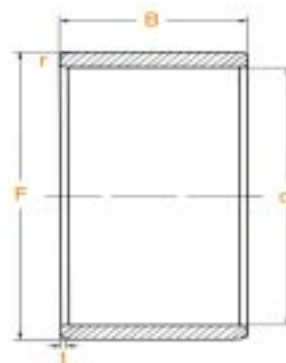

Designation	Dimensions d inch	F	B	r min.	Chamfer	Weight
					t	≈ kg
IRZ 242812	38.100 (1 1/2)	44.450 (1 3/4)	19.30	1.5	2	0.062
IRZ 242816		44.450 (1 3/4)	25.65	1.5	2	0.083
IRZ 253020	39.688 (1 9/16)	47.625 (1 7/8)	32.00	1.5	2	0.136
IRZ 263216	41.275 (1 5/8)	50.800 (2)	25.65	1.5	2	0.140
IRZ 263220		50.800 (2)	32.00	1.5	2	0.175
IRZ 283624	44.450 (1 3/4)	57.150 (2 1/4)	38.35	1.5	2	0.310
IRZ 283628		57.150 (2 1/4)	44.70	1.5	2	0.360
IRZ 324024	50.800 (2)	63.500 (2 1/2)	38.35	2	2	0.340
IRZ 324028		63.500 (2 1/2)	44.70	2	2	0.420
IRZ 364416		69.850 (2 3/4)	25.65	2	2.2	0.257
IRZ 364424	57.150 (2 1/4)	69.850 (2 3/4)	38.35	2	2.2	0.384
IRZ 364428		69.850 (2 3/4)	44.70	2	2.2	0.447
IRZ 404824	63.500 (2 1/2)	76.200 (3)	38.35	2	2.2	0.417
IRZ 404828		76.200 (3)	44.70	2	2.2	0.486
IRZ 425228	66.675 (2 5/8)	82.500 (3 1/4)	44.70	2	2.2	0.648
IRZ 425232		82.500 (3 1/4)	51.05	2	2.2	0.740
IRZ 445228	69.850 (2 3/4)	82.500 (3 1/4)	44.70	2	2.2	0.530
IRZ 485628		88.900 (3 1/2)	44.70	2	2.2	0.574
IRZ 485632	76.200 (3)	88.900 (3 1/2)	51.05	2	2.2	0.655
IRZ 506032	79.375 (3 1/8)	95.250 (3 3/4)	51.05	2.5	2.2	0.862
IRZ 546432	85.725 (3 3/8)	101.600 (4)	51.05	2.5	2.5	0.930
IRZ 586832	92.075 (3 5/8)	107.950 (4 1/4)	51.05	2.5	2.5	1.000
IRZ 607236	95.250 (3 3/4)	114.300 (4 1/2)	57.40	2.5	2.5	1.400
IRZ 627236	98.425 (3 7/8)	114.300 (4 1/2)	57.40	2.5	2.5	1.150
IRZ 627240		114.300 (4 1/2)	63.88	2.5	2.5	1.280
IRZ 648032		127.000 (5)	51.05	2.5	2.5	1.820
IRZ 648036	101.600 (4)	127.000 (5)	57.40	2.5	2.5	2.050
IRZ 648040		127.000 (5)	63.88	2.5	2.5	2.280

needle roller and cage assemblies

Series K

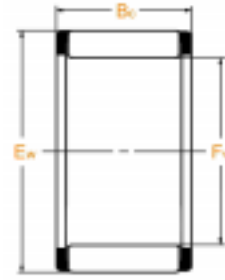

Shaft diameter	Designation	Dimensions			Weight ≈ kg	Basic radial load(kN)		Speed limit r/min
		F _w mm	E _w	B _c		grease C _r	oil C _{or}	
5	K 5x8x8 TN	5	8	8	0.0007	2.35	1.92	39 000
	K 5x8x10 TN	5	8	10	0.0009	3.0	2.65	39 000
6	K 6x9x8 TN	6	9	8	0.0008	2.6	2.28	37 000
	K 6x9x10 TN	6	9	10	0.0011	3.35	3.15	37 000
	K 6x10x13 TN	6	10	13	0.0019	3.8	3.1	35 000
7	K 7x9x7 TN	7	9	7	0.0006	1.73	1.77	35 000
	K 7x10x8 TN	7	10	8	0.0009	2.85	2.65	34 000
	K 7x10x8 TN	7	10	10	0.001	3.65	3.6	34 000
8	K 8x11x8 TN	8	11	8	0.001	3.1	3.0	32 000
	K 8x11x10 TN	8	11	10	0.0012	3.95	4.1	32 000
	K 8x11x13 TN	8	11	13	0.0017	5.1	5.8	32 000
8	K 8x12x8	8	12	8	0.0004	3.55	3.05	32 000
	K 8x12x10 TN	8	12	10	0.002	5.0	4.7	32 000
9	K 9x12x10 TN	9	12	10	0.0015	4.5	5.0	31 000
	K 9x12x13 TN	9	12	13	0.0021	5.9	7.1	31 000
10	K 10x13x10 TN	10	13	10	0.0016	4.75	5.5	29 000
	K 10x13x13 TN	10	13	13	0.0023	6.2	7.8	29 000
	K 10x13x16 TN	10	13	16	0.0029	7.1	9.3	29 000
10	K 10x14x10 TN	10	14	10	0.0025	5.8	6.0	29 000
	K 10x14x13 TN	10	14	13	0.0046	7.5	8.4	29 000
	K 10x16x12 TN	10	16	12	0.0055	8.1	7.2	28 000
12	K 12x15x10 TN	12	15	10	0.0029	4.9	6.1	27 000
	K 12x15x13 TN	12	15	13	0.0023	6.4	8.5	27 000
	K 12x15x20 ZW TN	12	15	20	0.005	8.4	12.2	27 000
12	K 12x16x10	12	16	10	0.0037	6.4	7.2	27 000
	K 12x16x13 TN	12	16	13	0.0055	8.0	9.4	27 000
	K 12x17x13 TN	12	17	13	0.0049	9.6	10.4	26 000
	K 12x18x12 TN	12	18	12	0.006	10.0	9.9	26 000

*TN: nylon cages, the allowed max working temperature + 120°C

*ZW: double row

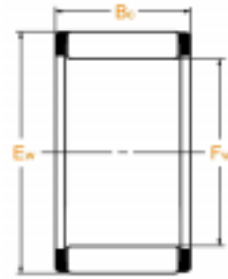

Shaft diameter	Designation	Dimensions			Weight ≈ kg	Basic radial load(kN)		Speed limit r/min
		F _w mm	E _w	B _c		grease C _r	oil C _{or}	
14	K 14x17x10	14	17	10	0.004	5.3	7.1	25 000
	K 14x17x17 TN	14	17	17	0.004	9.1	14.1	25 000
14	K 14x18x10	14	18	10	0.004	7.1	8.5	25 000
	K 14x18x13	14	18	13	0.0065	8.2	10.1	25 000
	K 14x18x14	14	18	14	0.006	9.5	12.3	25 000
14	K 14x18x15 TN	14	18	15	0.005	9.5	12.3	25 000
	K 14x18x17	14	18	17	0.008	10.8	14.4	25 000
	K 14x20x12	14	20	12	0.0085	10.3	10.6	24 000
15	K 15x19x10	15	19	10	0.005	7.5	9.2	24 000
	K 15x19x13	15	19	13	0.007	8.5	10.9	24 000
	K 15x19x17	15	19	17	0.0095	11.3	15.6	24 000
15	K 15x20x13	15	20	13	0.007	9.9	11.5	24 000
	K 15x21x15	15	21	15	0.011	14.3	16.4	24 000
	K 15x21x21	15	21	21	0.017	19.4	24.3	24 000
16	K 16x20x10	16	20	10	0.0055	7.8	9.9	24 000
	K 16x20x13	16	20	13	0.0075	8.9	11.8	24 000
	K 16x20x17	16	20	17	0.010	11.7	16.8	24 000
16	K 16x22x12	16	22	12	0.010	11.5	12.5	23 000
	K 16x22x13	16	22	13	0.012	12.4	13.9	23 000
	K 16x22x16	16	22	16	0.012	14.8	17.5	23 000
16	K 16x22x20	16	22	20	0.017	18.3	22.8	23 000
	K 16x24x20	16	24	20	0.022	21.4	23.5	22 000
17	K 17x21x10	17	21	10	0.0055	8.1	10.6	23 000
	K 17x21x13	17	21	13	0.0065	10.4	14.6	23 000
	K 17x21x17	17	21	17	0.0095	12.2	17.9	23 000
18	K 18x22x10	18	22	10	0.006	8.4	11.3	22 000
	K 18x22x13	18	22	13	0.008	9.2	12.7	22 000
	K 18x22x17	18	22	17	0.011	12.1	18	22 000

needle roller and cage assemblies

Series K

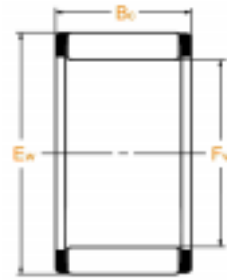

Shaft diameter	Designation	Dimensions			Weight ≈ kg	Basic radial load(kN)		Speed limit r/min
		F _w mm	E _w	B _c		grease C _r	oil C _{or}	
18	K 18x24x12	18	24	12	0.012	12.8	14.9	22 000
	K 18x24x13	18	24	13	0.013	13.1	15.3	22 000
	K 18x24x20	18	24	20	0.018	20.2	27	22 000
18	K 18x25x14	18	25	14	0.015	16.8	19.3	22 000
	K 18x25x22	18	25	22	0.023	23.1	29	22 000
	K 18x28x16	18	28	16	0.024	19.6	18.9	21 000
19	K 19x23x13	19	23	13	0.008	9.5	13.5	22 000
	K 19x23x17	19	23	17	0.011	12.5	19.2	22 000
20	K 20x24x10	20	24	10	0.0065	8.9	12.6	21 000
	K 20x24x12	20	24	12	0.008	9.8	14.3	21 000
	K 20x24x13	20	24	13	0.009	9.8	14.3	21 000
20	K 20x24x17	20	24	17	0.012	12.9	20.4	21 000
	K 20x26x12	20	26	12	0.011	13.4	16.2	21 000
	K 20x26x13	20	26	13	0.012	14.4	17.9	21 000
20	K 20x26x17	20	26	17	0.016	19.2	26	21 000
	K 20x26x20	20	26	20	0.019	21.1	29	21 000
	K 20x28x16	20	28	16	0.020	19.8	22.4	20 000
20	K 20x28x20	20	28	20	0.027	23.9	28.5	20 000
	K 20x28x25	20	28	25	0.032	30.5	39	20 000
	K 20x30x30	20	30	30	0.049	35.5	41.5	20 000

*TN: nylon cages, the allowed max working temperature + 120°C

*ZW: double row

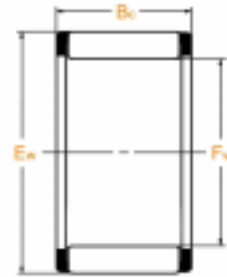

Shaft diameter	Designation	Dimensions			Weight ≈ kg	Basic radial load(kN)		Speed limit r/min
		F _w mm	E _w	B _c		grease C _r	oil C _{or}	
21	K 21x25x13	21	25	13	0.009	10.1	15.1	21 000
	K 21x25x17	21	25	17	0.010	13.3	21.5	21 000
22	K 22x26x10	22	26	10	0.0075	9.1	13.4	20 000
	K 22x26x13	22	26	13	0.0095	10.4	15.9	20 000
	K 22x26x17	22	26	17	0.012	13.7	22.7	20 000
22	K 22x28x17	22	28	17	0.018	19.4	27	20 000
	K 22x29x16	22	29	16	0.016	20	25.5	19 000
	K 22x30x15 TN	22	30	15	0.018	20.1	23.4	19 000
	K 22x32x24	22	32	24	0.043	34	40	18 000
23	K 23x35x16 TN	23	35	16	0.029	24.5	23.9	17 000
24	K 24x28x10	24	28	10	0.0085	9.6	14.8	19 000
	K 24x28x13	24	28	13	0.010	11	17.6	19 000
	K 24x28x17	24	28	17	0.013	14.5	25	19 000
24	K 24x29x13	24	29	13	0.014	13.6	19.7	18 000
	K 24x30x17	24	30	17	0.019	19.5	27.5	18 000
	K 24x30x31 ZW	24	30	31	0.032	27.5	43.5	18 000
25	K 25x29x10	25	29	10	0.0085	9.9	15.4	18 000
	K 25x29x13	25	29	13	0.011	11.3	18.4	18 000
	K 25x29x17	25	29	17	0.014	14.9	26	18 000
25	K 25x30x13	25	30	13	0.011	14.6	21.8	18 000
	K 25x30x17	25	30	17	0.016	18.7	30	18 000
	K 25x30x20	25	30	20	0.018	21.7	36.5	18 000

needle roller and cage assemblies

Series K

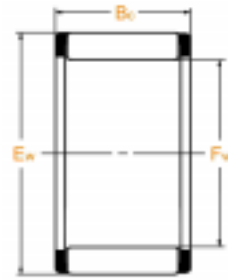

Shaft diameter	Designation	Dimensions			Weight ≈ kg	Basic radial load(kN)		Speed limit r/min
		F _w mm	E _w	B _c		grease C _r	oil C _{or}	
25	K 25x30x26 ZW	25	30	26	0.019	21.4	35.5	18 000
	K 25x31x17	25	31	17	0.019	19.6	28.5	18 000
	K 25x31x21	25	31	21	0.020	24.7	38	18 000
25	K 25x32x16	25	32	16	0.021	21	28	17 000
	K 25x33x20	25	33	20	0.033	28.5	38	17 000
	K 25x33x24	25	33	24	0.039	34	47	17 000
	K 25x35x30	25	35	30	0.065	47	62	16 000
26	K 26x30x10	26	30	10	0.007	10.1	16.1	18 000
	K 26x30x13	26	30	13	0.011	11.6	19.2	18 000
	K 26x30x17	26	30	17	0.015	15.2	27.5	18 000
	K 26x30x22 ZW	26	30	22	0.012	15.7	28.5	18 000
28	K 28x33x13	28	33	13	0.013	15.3	24.2	16 000
	K 28x33x17	28	33	17	0.017	19.7	33.5	16 000
	K 28x33x27 TN	28	33	27	0.019	23.3	41	16 000
28	K 28x34x17	28	34	17	0.024	21.8	33.5	16 000
	K 28x35x16	28	35	16	0.024	21.5	29.5	16 000
	K 28x35x18	28	35	18	0.027	24	34	16 000
28	K 28x35x27	28	35	27	0.041	35	55	16 000
	K 28x40x18	28	40	18	0.050	33.5	37	14 000
	K 28x40x25	28	40	25	0.070	45.5	55	14 000
30	K 30x34x13	30	34	13	0.014	12.3	21.7	15 000
	K 30x35x13	30	35	13	0.014	15.6	25.5	15 000
	K 30x35x17	30	35	17	0.019	19.6	34	15 000
30	K 30x35x26 ZW	30	35	26	0.036	24	44	15 000
	K 30x35x27	30	35	27	0.030	30.5	59	15 000
	K 30x37x16	30	37	16	0.027	23.1	33.5	15 000
30	K 30x37x18	30	37	18	0.030	26	38.5	15 000
	K 30x40x18	30	40	18	0.048	32	40	14 000
	K 30x40x30	30	40	30	0.073	49	69	15 000

*TN: nylon cages, the allowed max working temperature + 120°C

*ZW: double row

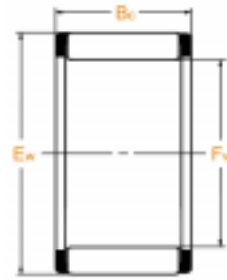

Shaft diameter	Designation	Dimensions			Weight ≈ kg	Basic radial load(kN)		Speed limit r/min
		F _w mm	E _w	B _c		grease C _r	oil C _{or}	
32	K 32x37x13	32	37	13	0.018	15.5	25.5	14 000
	K 32x37x17	32	37	17	0.019	19.9	35.5	14 000
	K 32x37x27	32	37	27	0.030	30	60	14 000
32	K 32x37x28 TN	32	37	28	0.021	23.6	43.5	14 000
	K 32x38x16	32	38	16	0.025	21.5	34.5	14 000
	K 32x38x20	32	38	20	0.030	26.5	45	14 000
32	K 32x38x26	32	38	26	0.038	33.5	61	14 000
	K 32x39x16	32	39	16	0.037	23.8	35.5	14 000
	K 32x39x18	32	39	18	0.031	26.5	41	14 000
32	K 32x40x25	32	40	25	0.049	37.5	58	14 000
	K 32x40x36	32	40	36	0.073	54	92	14 000
	K 32x40x42 ZW TN	32	40	42	0.077	50	84	14 000
	K 32x46x32	32	46	32	0.119	66	83	13 000
35	K 35x40x13	35	40	13	0.019	16.2	28	13 000
	K 35x40x17	35	40	17	0.021	20.8	38.5	13 000
	K 35x40x25	35	40	25	0.031	29.5	60	13 000
35	K 35x40x27 TN	35	40	27	0.039	25	48.5	13 000
	K 35x40x30 ZW	35	40	30	0.048	25.5	50	13 000
	K 35x40x32 ZW	35	40	32	0.050	32	66	13 000
35	K 35x42x16	35	42	16	0.034	24.4	37.5	13 000
	K 35x42x18	35	42	18	0.034	27.5	43	13 000
	K 35x42x20	35	42	20	0.037	30	49	13 000
35	K 35x42x30	35	42	30	0.067	39	68	13 000
	K 35x43x18	35	43	18	0.038	28.5	42	13 000
	K 35x45x20	35	45	20	0.056	37	50	12 000
35	K 35x45x30	35	45	30	0.080	53	79	12 000
	K 35x45x49	35	45	49	0.138	82	139	12 000
	36 K 36x42x16	36	42	16	0.029	24.6	42.5	13 000
37	K 37x42x17	37	42	17	0.022	22.4	43	12 000
	K 37x42x27	37	42	27	0.041	32	68	12 000
	K 37x45x26	37	45	26	0.061	44	74	12 000

*TN: nylon cages, the allowed max working temperature + 120°C

*ZW: double row

needle roller and cage assemblies

Series K

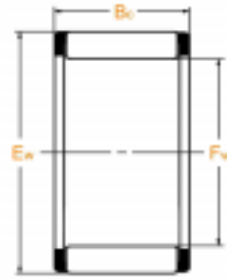

Shaft diameter	Designation	Dimensions			Weight ≈ kg	Basic radial load(kN)		Speed limit r/min
		F _w mm	E _w	B _c		grease C _r	oil C _{or}	
38	K 38x43x17	38	43	17	0.029	20.5	38.5	12 000
	K 38x43x27	38	43	27	0.043	31.5	68	12 000
	K 38x46x20	38	46	20	0.047	35.5	57	12 000
	K 38x46x32	38	46	32	0.076	55	99	12 000
39	K 39x44x24	39	44	24	0.030	28.5	59	12 000
	K 39x44x26 ZW	39	44	26	0.045	27.5	56	12 000
40	K 40x44x13	40	44	13	0.018	14	28.5	12 000
	K 40x45x13	40	45	13	0.022	17.6	32.5	12 000
	K 40x45x17	40	45	17	0.031	21.4	41.5	12 000
40	K 40x45x21	40	45	21	0.033	24.9	50	12 000
	K 40x45x27	40	45	27	0.046	33	73	12 000
	K 40x45x30 ZW	40	45	30	0.058	26.5	54	12 000
40	K 40x46x17	40	46	17	0.028	25	45	11 000
	K 40x47x18	40	47	18	0.039	29.5	50	11 000
	K 40x47x20	40	47	20	0.042	32.5	57	11 000
	K 40x48x20	40	48	20	0.049	36	59	11 000
42	K 42x47x13	42	47	13	0.018	17.6	33.5	11 000
	K 42x47x17	42	47	17	0.032	21.7	43	11 000
	K 42x47x25 TN	42	47	25	0.026	27.5	58	11 000
42	K 42x47x27	42	47	27	0.049	33.5	75	11 000
	K 42x47x30 ZW	42	47	30	0.054	33.5	76	11 000
	K 42x50x18	42	50	18	0.053	31.5	50	11 000
	K 42x50x20	42	50	20	0.053	35	57	11 000
43	K 43x48x17	43	48	17	0.030	21.6	43	11 000
	K 43x48x27	43	48	27	0.050	33.5	75	11 000
	K 43x50x18	43	50	18	0.041	31	54	11 000

*TN: nylon cages, the allowed max working temperature + 120°C

*ZW: double row

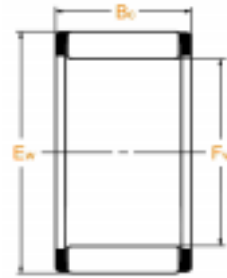

Shaft diameter	Designation	Dimensions			Weight ≈ kg	Basic radial load(kN)		Speed limit r/min
		F _w mm	E _w	B _c		grease C _r	oil C _{or}	
45	K 45x49x19	45	49	19	0.027	18	40.5	10 000
	K 45x50x17	45	50	17	0.034	22.5	46	10 000
	K 45x50x27	45	50	27	0.051	34.5	80	10 000
45	K 45x50x32 TN	45	50	32	0.045	38.5	91	10 000
	K 45x51x36 ZW	45	51	36	0.085	45	99	10 000
	K 45x52x18	45	52	18	0.042	31.5	57	10 000
45	K 45x52x21 TN	45	52	21	0.034	30	52	10 000
	K 45x53x20	45	53	20	0.055	39	67	10 000
	K 45x53x21	45	53	21	0.060	38.5	67	10 000
	K 45x53x22	45	53	22	0.060	42.5	76	10 000
45	K 45x53x28	45	53	28	0.081	52	98	10 000
	K 45x59x18 TN	45	59	18	0.072	44	54	9 500
	K 45x59x32	45	59	32	0.148	73	102	9 500
	K 45x59x36	45	59	36	0.159	76	109	9 500
47	K 47x52x17	47	52	17	0.035	23.3	49	10 000
	K 47x52x27	47	52	27	0.051	35	83	10 000
	K 47x53x25	47	53	25	0.051	38.5	82	10 000
47	K 47x55x28	47	55	28	0.080	53	101	9 500
48	K 48x54x19	48	54	19	0.046	30.5	61	9 500
50	K 50x55x13.5	50	55	13.5	0.030	18.2	36.5	9 500
50	K 50x55x17	50	55	17	0.035	22.1	47	9 500
	K 50x55x20	50	55	20	0.043	26.5	60	9 500
	K 50x55x30	50	55	30	0.065	39	97	9 500
50	K 50x57x18	50	57	18	0.047	33.5	63	9 000
	K 50x58x20	50	58	20	0.075	35.5	62	9 000
	K 50x58x25	50	59	25	0.090	44	81	9 000

*TN: nylon cages, the allowed max working temperature + 120°C
 *ZW: double row

caged type drawn cup needle bearings

Series HK BK



					HK		BK			
Shaft diameter	With open ends		With closed ends		Dimensions					
	Designation	Weight ≈ kg	Designation	Weight ≈ kg	Fw mm	D	C -0,3	C _t min.	r min.	
3	+ HK 0306 TN	0.001	+ BK 0306 TN	0.001	3	6,5	6	5,2	0,3	
4	+ HK 0408	0.002	+ BK 0408	0.0021	4	8	8	6,4	0,3	
5	+ HK 0509	0.002	+ BK 0509	0.0021	5	9	9	7,4	0,4	
6	+ HK 0608	0.0021	–	–	6	10	8	–	0,4	
	HK 0609	0.0025	BK 0609	0.0026	6	10	9	7,4	0,4	
7	HK 0709	0.0026	BK 0709	0.0029	7	11	9	7,4	0,4	
8	HK 0808	0.0027	BK 0808	0.003	8	12	8	6,4	0,4	
	HK 0810	0.003	BK 0810	0.0034	8	12	10	8,4	0,4	
9	HK 0908	0.003	–	–	9	13	8	–	0,4	
	HK 0910	0.004	BK 0910	0.0043	9	13	10	8,4	0,4	
	HK 0912	0.0046	BK 0912	0.0049	9	13	12	10,4	0,4	
10	HK 1010	0.0041	BK 1010	0.0043	10	14	10	8,4	0,4	
	HK 1012	0.0048	BK 1012	0.005	10	14	12	10,4	0,4	
	HK 1015	0.006	BK 1015	0.0062	10	14	15	13,4	0,4	
12	HK 1210	0.0046	BK 1210	0.0052	12	16	10	8,4	0,4	
	HK 1212	0.009	BK 1212	0.010	12	18	12	9,3	0,8	
13	HK 1312	0.010	BK 1312	0.011	13	19	12	9,3	0,8	
14	HK 1412	0.0105	BK 1412	0.012	14	20	12	9,3	0,8	

TN = plastic cages, the allowed max working temperature +120 (continues running)

+ = without lubrication hole

⁰ = double-row with standard lubrication oil hole

¹⁾ = see page 40, 41, 42, and 43 for other inner rings

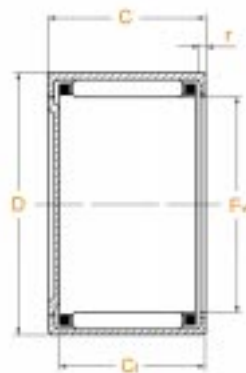
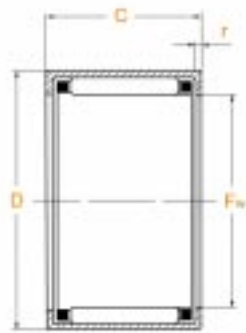

HK

Series BK 3<Fw<25

Basic radial load(kN)		Fatigue load Pu kN	Limiting speed nL r/min	Reference sped nR r/min	Suitable inner ring ¹ (order separately) IR Designation	Shaft diameter
dyn. Cr	stat. Cor					
1.23	0.84	0.085	46 000	65 000	–	3
1.78	1.31	0.146	41 000	50 000	–	4
2.4	1.99	0.235	38 000	42 000	–	5
2.03	1.65	0.181	35 000	36 000	–	
2.85	2.6	0.305	35 000	35 000	–	6
3.1	2.95	0.35	31 000	31 000	–	
2.75	2.6	0.285	28 000	27 000	–	7
3.8	3.95	0.49	28 000	27 000	IR 5x8x12	8
3.55	3.75	0.43	25 000	23 000	–	
4.25	4.65	0.58	25 000	24 000	–	9
5.3	6.3	0.81	25 000	23 000	IR 6X9X12	
4.4	5.1	0.63	23 000	22 000	IR 7X10X10,5	
5.5	6.8	0.88	23 000	21 000	IR 7X10X12	10
6.8	8.8	1.07	23 000	21 000	IR 7X10X16	
4.95	6.2	0.77	20 000	18 000	IR 8X12X10,5	12
6.5	7.3	0.85	19 000	18 000	IR 8X12X12,5	
6.8	7.9	0.92	18 000	17 000	IR 10X13X12,5	13
7.1	8.5	0.99	16 000	16 000	IR 10X14X13	14

TN = plastic cages, the allowed max working temperature +120 (continues running)

+ = without lubrication hole

° = double-row with standard lubrication oil hole

')} = see page 40, 41, 42, and 43 for other inner rings

caged type drawn cup needle bearings

Series HK BK



	HK	BK
--	----	----

Shaft diameter	With open ends		With closed ends		Dimensions				
	Designation	Weight ≈ kg	Designation	Weight ≈ kg	Fw mm	D	C -0,3	C _t min.	r min.
15	HK 1512	0.011	BK 1512	0.013	15	21	12	9,3	0,8
	HK 1516	0.015	BK 1516	0.017	15	21	16	13,3	0,8
	HK 1522	0.020	–	–	15	21	22	–	0,8
16	^o HK 1612	0.012	BK 1612	0.014	16	22	12	9,3	0,8
	HK 1616	0.016	BK 1616	0.018	16	22	16	13,3	0,8
17	^o HK 1622	0.022	^o BK 1622	0.024	16	22	22	19,3	0,8
18	HK 1712	0.012	–	–	17	23	12	–	0,8
	HK 1812	0.013	BK 1812	0.015	18	24	12	9,3	0,8
20	HK 1816	0.018	BK 1816	0.020	18	24	16	13,3	0,8
	HK 2010	0.012	–	–	20	26	10	–	0,8
	HK 2012	0.014	–	–	20	26	12	–	0,8
20	HK 2016	0.019	BK 2016	0.022	20	26	16	13,3	0,8
	HK 2020	0.024	BK 2020	0.027	20	26	20	17,3	0,8
22	^o HK 2030	0.035	–	–	20	26	30	–	0,8
	HK 2210	0.013	–	–	22	28	10	–	0,8
	HK 2212	0.015	BK 2122	0.018	22	28	12	9,3	0,8
22	HK 2216	0.021	BK 2216	0.024	22	28	16	13,3	0,8
	HK 2220	0.026	–	–	22	28	20	–	0,8

TN = plastic cages, the allowed max working temperature +120 (continues running)

+ = without lubrication hole

^o = double-row with standard lubrication oil hole

¹⁾ = see page 40, 41, 42, and 43 for other inner rings

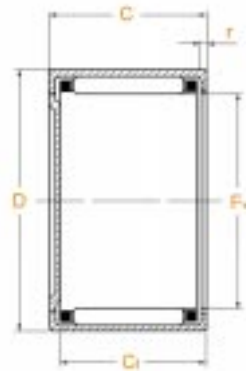
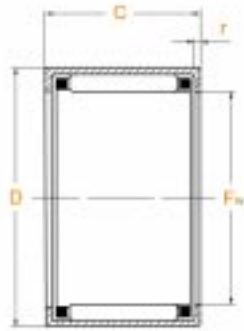

HK

Series BK 3<Fw<25

Basic radial load(kN)		Fatigue load Pu kN	Limiting speed Nc r/min	Reference speed Ns r/min	Suitable inner ring ¹⁾ (order separately) IR Designation	Shaft diameter
dyn. Cr	stat. Cor					
7.9	9.4	1.11	16 000	14 000	IR 12X15X12,5	15
10.5	14.4	1.75	16 000	14 000	IR 12X15X16,5	
13.4	19.5	2.29	16 000	14 000	IR 12X15X22,5	
7.6	9.7	1.13	15 000	14 000	IR 12X16X13	16
10.9	15.3	1.87	15 000	13 000	IR 12X16X16	
13.1	19.4	2.27	15000	14 000	IR 12X16X22	17
7.9	10.3	1.2	14 000	13 000	–	
8.1	10.9	1.27	13 000	12 000	–	18
11.6	17.3	2.1	13 000	12 000	IR 15X18X16,5	
6.4	8.2	0.99	12 000	12 000	–	
8.6	12.1	1.41	12 000	11 000	IR 15X20X13	20
12.7	20.1	2.47	12 000	11 000	IR 17X20X16,5	
15.7	26	3.35	12 000	11 000	IR 17X20X20,5	
21.8	40	4.95	12 000	11 000	IR 17X20X30,5	22
7.5	10.5	1.28	11 000	10 000	–	
9.1	13.4	1.56	11 000	10 000	IR 17X22X13	
13.4	22.1	2.7	11 000	10 000	IR 17X22X16	22
16.5	29	3.7	11 000	10 000	IR 17X22X23	

TN = plastic cages, the allowed max working temperature +120 (continues running)

+ = without lubrication hole

° = double-row with standard lubrication oil hole

¹⁾ = see page 40, 41, 42, and 43 for other inner rings

caged type drawn cup needle bearings

Series HK BK



HK	BK
----	----

Shaft diameter	With open ends		With closed ends		Dimensions				
	Designation	Weight ≈ kg	Designation	Weight ≈ kg	Fw mm	D	C -0,3	C _t min.	r min.
25	HK 2512	0.020	–	–	25	32	12	–	0,8
	HK 2516	0.027	–	–	25	32	16	–	0,8
	HK 2520	0.033	BK 2520	0.038	25	32	20	17,3	0,8
25	HK 2526	0.044	BK 2526	0.048	25	32	26	23,3	0,8
	^o HK 2538	0.064	^o BK 2538	0.068	25	32	38	35,3	0,8
28	HK 2816	0.029	–	–	28	35	16	–	0,8
	HK 2820	0.036	–	–	28	35	20	–	0,8
30	HK 3012	0.023	BK3012	0.028	30	37	12	9,3	0,8
	HK 3016	0.031	BK 3016	0.038	30	37	16	13,3	0,8
	HK 3020	0.039	BK 3020	0.047	30	37	20	17,3	0,8
30	HK 3026	0.051	BK 3026	0.058	30	37	26	13,3	0,8
	^o HK 3038	0.076	^o BK 3038	0.084	30	37	38	35,3	0,8
35	HK 3512	0.027	–	–	35	42	12	–	0,8
	HK 3516	0.036	–	–	35	42	16	–	0,8
	HK 3520	0.044	BK 3520	0.053	35	42	20	17,3	0,8
40	HK 4012	0.030	–	–	40	47	12	–	0,8
	HK 4016	0.039	–	–	40	47	16	–	0,8
	HK 4020	0.054	BK 4020	0.062	40	47	20	17,3	0,8
45	HK 4512	0.033	–	–	45	52	12	–	0,8
	HK 4516	0.046	–	–	45	52	16	–	0,8
	HK 4520	0.056	BK 4520	0.072	45	52	20	17,3	0,8
50	HK 5020	0.070	–	–	50	58	20	–	0,8
	HK 5025	0.090	–	–	50	58	25	–	0,8

TN = plastic cages, the allowed max working temperature +120 (continues running)

^o = double-row with standard lubrication oil hole

¹⁾ = see page 40, 41, 42, and 43 for other inner rings

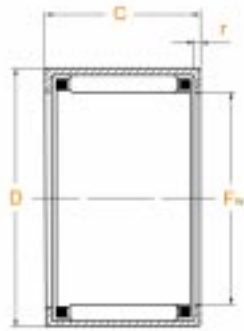

HK

Series BK Fw ≥ 25

Basic radial load(kN)		Fatigue load Pu kN	Limiting speed n _c r/min	Reference sped n _s r/min	Suitable inner ring*(order separately) IR Designation	Shaft diameter
dyn. C _r	stat. C _{0r}					
11	15.2	1.81	10 000	9 000	–	
15.6	24	2.95	10 000	9 000	IR 20x25x17	25
19.9	33	3.9	10 000	8 500	IR 20X25X20,5	
25.5	45	5.7	10 000	8 500	IR 20X25X26,5	25
34	66	7.8	10 000	8 500	IR 20X25X38,5	
16.4	26.5	3.25	9 000	8 000	IR 22X28X17	28
20.9	36	4.3	9 000	8 000	IR 22X28X20,5	
12.1	18.2	2.17	8 500	7 500	–	
17.2	29	3.5	8 500	7 500	IR 25X30X17	30
22	39.5	4.7	8 500	7 500	IR 25X30X20,5	
28	54	6.8	8 500	7 500	IR 25X30X26,5	30
37.5	79	9.4	8 500	7 500	IR 25X30X38,5	
13.1	21.3	2.55	7 500	6 600	–	
18.7	33.5	4.1	7 500	6 500	IR 30X35X17	35
23.8	46	5.5	7 500	6 500	IR 30X35X20,5	
14	24.3	2.9	6 500	6 000	–	
20	38.5	4.7	6 500	6 000	IR 35X40X17	40
25.5	52	6.3	6 500	5 500	IR 35X40X20,5	
14.9	27.5	3.25	6 000	5 500	–	
21.3	43	5.3	6 000	5 500	IR 40X45X17	45
27	59	7	6 000	5 000	IR 40X45X20,5	
31	63	7.6	5 000	4 700	–	50
38.5	84	10.8	5 000	4 700	IR 45X50X25,5	

caged type drawn cup needle bearings

Series **HK..RS**
 Series **HK..2RS**
 Series **BK..RS**



	HK..RS	HK..2RS	BK..RS
--	--------	---------	--------

Shaft diameter	With open ends sealed on one side		With open ends sealed on both side		With open ends sealed on one side		Dimensions					
	Designation	Weight ≈ kg	Designation	Weight ≈ kg	Designation	Weight ≈ kg	Fw mm	D	C -0,3	C ₁ -0,3	C ₂ min.	r min.
8	HK 0810 RS	0.003	HK 0812.2RS	0.0033	–	–	8	12	10	12	–	0,4
10	HK 1012 RS	0.0042	HK 1014.2RS	0.0046	–	–	10	14	12	14	–	0,4
12	HK 1214 RS	0.010	HK 1216.2RS	0.011	–	–	12	18	14	16	–	0,8
14	HK 1414 RS	0.012	HK 1416.2RS	0.013	BK 1414 RS	0.013	14	20	14	16	11,3	0,8
15	HK 1514 RS	0.012	HK 1516.2RS	0.014	–	–	15	21	14	16	–	0,8
	HK 1518 RS	0.016	HK 1520.2RS	0.018	–	–	15	21	18	20	–	0,8
16	HK 1614 RS	0.013	HK 1616.2RS	0.014	BK 1614 RS	0.015	16	22	14	16	11,3	0,8
	–	–	HK 1620.2RS	0.018	–	–	16	22	–	20	–	0,8
18	HK 1814 RS	0.014	HK 1816.2RS	0.015	–	–	18	24	14	16	–	0,8
20	–	–	HK 2016.2RS	0.018	–	–	20	26	–	16	–	0,8
	HK 2018 RS	0.021	HK 2020.2RS	0.023	BK 2018 RS	0.024	20	26	18	20	15,3	0,8
22	HK 2214 RS	0.016	HK 2216.2RS	0.018	–	–	22	28	14	16	–	0,8
	HK 2218 RS	0.024	HK 2220.2RS	0.026	–	–	22	28	18	20	–	0,8

1) limit speed with lubricating grease
 2) see page 40, 41, 42, and 43 for other inner rings

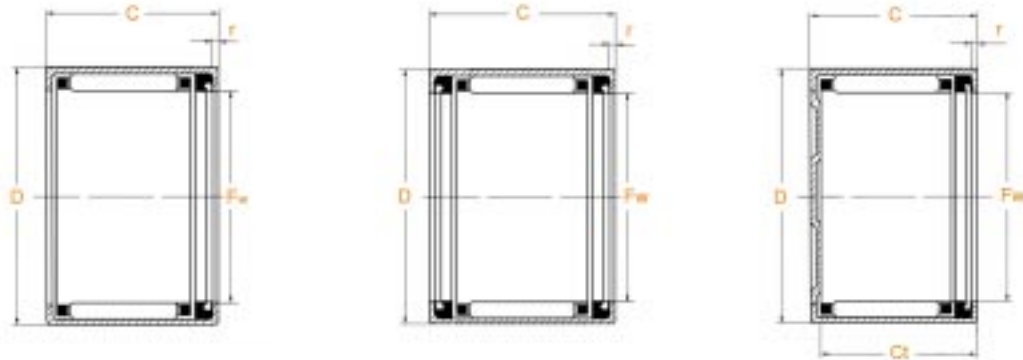

HK..RS

HK..2RS

BK..RS

Basic radial load(kN)		Fatigue load Pu kN	Limiting speed No grease r/min	Suitable inner ring*(order separately)		Shaft diameter
dyn. Cr	stat. Cor			HK..RS and HK..2RS IR Designation	HK..RS IR Designation	
2.75	2.6	0.285	20 000	–	–	8
4.4	5.1	0.63	17 000	–	–	10
6.5	7.3	0.85	14 000	–	–	12
7.1	8.5	0.99	12 000	–	–	14
7.8	9.8	1.15	11 000	IR 12x15x16,5	–	15
10.5	14.4	1.75	11 000	–	–	
7.6	9.7	1.13	11 000	IR 12x16x20	IR 12x16x13	16
10.9	15.3	1.87	11 000	–	–	
8.1	10.9	1.27	9 500	IR 15x18x16,5	–	18
8.6	12.1	1.41	8 500	IR 17x20x16,5	–	20
12.7	20.1	2.47	8 500	IR 17x20x20,5	–	
9.1	13.4	1.56	8 000	IR 17x22x16	–	22
13.4	22.1	2.7	8 000	IR 17x22x23	–	

caged type drawn cup needle bearings

Series HK..RS
Series HK..2RS
Series BK..RS



	HK..RS	HK..2RS	BK..RS
--	--------	---------	--------

Shaft diameter	With open ends sealed on one side		With open ends sealed on both side		With open ends sealed on one side		Dimensions					
	Designation	Weight ≈ kg	Designation	Weight ≈ kg	Designation	Weight ≈ kg	Fw mm	D	C -0,3	C ₁ -0,3	C ₂ min.	r min.
25	–	–	HK 2516.2RS	0.027	–	–	25	32	–	16	–	0,8
	HK 2518 RS	0.029	HK 2520.2RS	0.031	BK 2518 RS	0.034	25	32	18	20	15,3	0,8
	–	–	HK 2524.2RS	0.040	–	–	25	32	–	24	–	0,8
	–	–	HK 2530.2RS	0.047	–	–	25	32	–	30	–	0,8
28	HK 2818 RS	0.031	HK 2820.2RS	0.034	–	–	28	35	18	20	–	0,8
	–	–	HK 3016.2RS	0.031	–	–	30	37	–	16	–	0,8
30	HK 3018 RS	0.037	HK 3020.2RS	0.036	–	–	30	37	18	20	–	0,8
	–	–	HK 3024.2RS	0.044	–	–	30	37	–	24	–	0,8
35	–	–	HK 3516.2RS	0.032	–	–	35	42	–	16	–	0,8
	HK 3518 RS	0.039	HK 3520.2RS	0.041	–	–	35	42	18	20	–	0,8
40	–	–	HK 4016.2RS	0.037	–	–	40	47	–	16	–	0,8
	HK 4018 RS	0.045	HK 4020.2RS	0.048	–	–	40	47	18	20	–	0,8
45	HK 4518 RS	0.050	HK 4520.2RS	0.054	–	–	45	52	18	20	–	0,8
50	HK 5022 RS	0.076	HK 5024.2RS	0.081	–	–	50	58	22	24	–	0,8

1) limit speed with lubricating grease
2) see page 40, 41, 42, and 43 for other inner rings



HK..RS

HK..2RS

BK..RS

Basic radial load(kN)		Fatigue load P_u kN	Limiting speed n_g grease r/min	Suitable inner ring ¹ (order separately)		Shaft diameter
dyn. C_r	stat. C_{or}			HK..RS and HK..2RS IR Designation	HK..RS IR Designation	
11	15.2	1.81	7 000	IR 20x25x17	–	25
15.6	24	2.95	7 000	IR 20x25x20,5	–	
19.9	33	3.9	7 000	–	–	
25.5	45	5.7	7 000	IR 20x25x30	–	
16.4	26.5	3.25	6 000	IR 22x28x20,5	–	28
12.1	18.2	2.17	6 000	IR 25x30x17	–	30
17.2	29	3.5	6 000	IR 25x30x20,5	–	
22	39.5	4.7	6 000	–	–	
13.1	21.3	2.55	5 000	IR 30x35x17	–	35
18.7	33.5	4.1	5 000	IR 30x35x20,5	–	
14	24.3	2.9	4 500	IR 35x40x17	–	40
20	38.5	4.7	4 500	IR 35x40x20,5	–	
21.3	43	5.3	4 000	IR 40x45x20,5	–	45
31	63	7.6	3 600	IR 45x50x25,5	–	

caged type drawn cup needle bearings

Series SCE/SCH

Series BCE/BCH



		SCE,SCH				BCE,BCH		
With open ends Shaft diameter	With closed ends Designation	Weight ≈ kg	Dimensions		C	Basic radial load(kN)		Limiting speed n _s r/min
			Fw inch	D		dyn. C _r	stat. C _{0r}	
SCE44	BCE44	0.002	0.250	0.437	0.250	1.6	1.2	44 000
SCE45	BCE45	0.003	0.250	0.437	0.313	2.5	2.09	44 000
SCE47	BCE47	0.004	0.250	0.437	0.437	4.0	3.85	44 000
SCE55	BCE55	0.004	0.313	0.500	0.313	2.9	2.6	35 500
SCE57	BCE57	0.006	0.313	0.500	0.437	4.7	4.85	35 500
SCE59	BCE59	0.006	0.313	0.500	0.563	6.0	6.6	35 500
SCH57	BCH57	0.007	0.313	0.563	0.437	4.75	4.1	35 500
SCE65	BCE65	0.003	0.375	0.563	0.313	2.9	2.7	29 500
SCE66	BCE66	0.004	0.375	0.563	0.375	3.9	3.95	29 500
SCE67	BCE67	0.005	0.375	0.563	0.437	5.35	4.6	29 500
SCE68	BCE68	0.006	0.375	0.563	0.500	5.8	6.6	29 500
SCE610	BCE610	0.007	0.375	0.563	0.625	7.4	9.0	29 500
SCH68	BCH68	0.009	0.375	0.625	0.500	7.1	7.1	29 500
SCE78	BCE78	0.007	0.437	0.625	0.500	6.4	7.8	25 000
SCE710	/	0.009	0.437	0.625	0.625	8.1	7.7	25 000
SCH78	BCH78	0.009	0.438	0.688	0.500	7.9	8.2	25 000
SCE85	BCE85	0.004	0.500	0.687	0.313	3.65	3.95	22 000
SCE86	BCE86	0.005	0.500	0.687	0.375	4.6	5.4	22 000
SCE87	BCE87	0.006	0.500	0.687	0.437	5.9	7.4	22 000
SCE88	BCE88	0.007	0.500	0.687	0.500	6.9	9.0	22 000
SCE810	BCE810	0.009	0.500	0.687	0.625	8.8	12.3	22 000
SCE812	BCE812	0.011	0.500	0.687	0.750	9.9	14.3	22 000
SCH87	BCH87	0.009	0.500	0.750	0.438	7.34	7.8	22 000
SCH88	BCH88	0.010	0.500	0.750	0.500	8.5	9.4	22 000
SCH810	BCH810	0.010	0.500	0.750	0.625	10.5	12.4	22 000
SCH812	BCH812	0.016	0.500	0.750	0.750	12.6	15.7	22 000

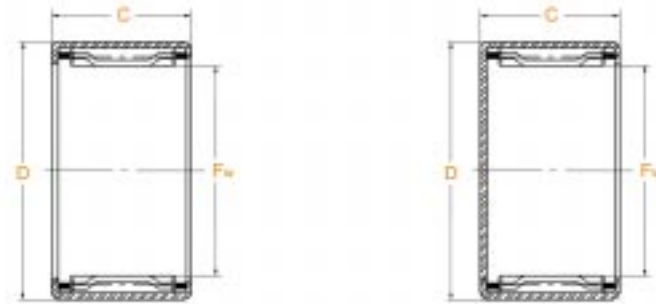

			SCE,SCH			BCE,BCH		
With open ends Shaft diameter	With closed ends Designation	Weight ≈ kg	Dimensions			Basic radial load(kN)		Limiting speed n _e r/min
			F _w inch	D	C	dyn. C _r	stat. C _{0r}	
SCE95	/	0.005	0.563	0.750	0.313	4	4.7	19 600
SCE96	BCE96	0.006	0.563	0.750	0.375	5.2	6.4	19 600
SCE97	/	0.008	0.563	0.750	0.438	6.6	8.8	19 600
SCE98	BCE98	0.009	0.563	0.750	0.500	7.7	10.8	19 600
SCE910	BCE910	0.010	0.563	0.750	0.625	9.6	14	19 600
SCE912	BCE912	0.012	0.563	0.750	0.750	10.7	16.4	19 600
SCH98	BCH98	0.012	0.563	0.813	0.500	9.1	10.6	19 600
SCH910	BCH910	0.013	0.563	0.813	0.625	12	15	19 600
SCH912	BCH912	0.017	0.563	0.813	0.750	14.4	19	19 600
SCE105	BCE105	0.005	0.625	0.813	0.313	4.3	5.2	17 600
SCE107	BCE107	0.008	0.625	0.813	0.437	6.6	9.3	17 600
SCE107-1/2	BCE107-1/2	0.008	0.625	0.813	0.469	7.1	10.3	17 600
SCE108	BCE108	0.009	0.625	0.813	0.500	8.1	12	17 600
SCE1010	BCE1010	0.011	0.625	0.813	0.625	10.4	16.3	17 600
SCE1012	BCE1012	0.014	0.625	0.813	0.750	12.1	19.7	17 600
SCH108	BCH108	0.013	0.625	0.875	0.500	10	12.2	17 600
SCH1010	BCH1010	0.016	0.625	0.875	0.625	12.7	16.7	17 600
SCH1012	BCH1012	0.019	0.625	0.875	0.750	14.7	20	17 600
SCH1016	BCH1016	0.025	0.625	0.875	1.000	19.1	28	17 600
SCE116	/	0.006	0.687	0.875	0.375	5.7	7.9	16 000
SCE118	BCE118	0.010	0.687	0.875	0.500	8.6	13.2	16 000
SCE1110	BCE1110	0.013	0.687	0.875	0.625	10.9	18	16 000
SCE1112	BCE1112	0.016	0.687	0.875	0.750	12.4	21	16 000
SCH117	BCH117	0.013	0.688	0.938	0.437	8.4	10	16 000
SCH1110	BCH1110	0.017	0.688	0.938	0.625	12.9	17.1	16 000
SCH1112	BCH1112	0.020	0.688	0.938	0.750	15.9	22.7	16 000

caged type drawn cup needle bearings

Series SCE/SCH

Series BCE/BCH



SCE,SCH

BCE,BCH

With open ends Shaft diameter	With closed ends Designation	Weight ≈ kg	Dimensions			Basic radial load(kN)		Limiting speed nc r/min
			Fw inch	D	C	dyn. Cr	stat. Cor	
SCE126	BCE126	0.010	0.750	1.000	0.375	7.1	8.3	14 700
SCE128	BCE128	0.014	0.750	1.000	0.500	9.8	12.5	14 700
SCE1210	BCE1210	0.018	0.750	1.000	0.625	12.8	17.5	14 700
SCE1212	BCE1212	0.021	0.750	1.000	0.750	15.3	22.1	14 700
SCH1212	BCH1212	0.027	0.750	1.063	0.750	18.5	23.6	14 700
SCE136	/	0.014	0.813	1.063	0.375	7.1	8.4	13 600
SCE138	BCE138	0.016	0.813	1.063	0.500	10.8	14.3	13 600
SCE1312	BCE1312	0.024	0.813	1.063	0.750	15.9	23.7	13 600
SCE1314	/	0.027	0.813	1.063	0.875	18.5	29	13 600
SCH1310	BCH1310	0.025	0.813	1.125	0.625	15.9	20.7	13 600
SCH1312	BCH1312	0.030	0.813	1.125	0.750	19.2	26.5	13 600
SCE146	BCE146	0.013	0.875	1.125	0.375	8.2	10.7	12 600
SCE148	BCE148	0.019	0.875	1.125	0.500	11.2	15.8	12 600
SCE1412	BCE1412	0.028	0.875	1.125	0.750	16.9	27	12 600
SCE1416	BCE1416	0.034	0.875	1.125	1.000	22.1	38	12 600
SCH1412	BCH1412	0.032	0.875	1.188	0.750	19.5	27	12 600
SCH1416	BCH1416	0.043	0.875	1.188	1.000	25.5	38.5	12 600
SCE1516	BCE1516	0.038	0.937	1.187	1.000	24.1	43	11 800

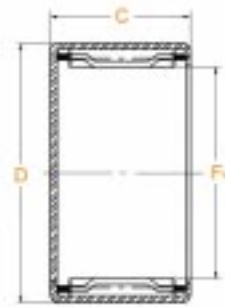

			SCE,SCH			BCE,BCH		
With open ends Shaft diameter	With closed ends Designation	Weight ≈ kg	Dimensions			Basic radial load(kN)		Limiting speed
			Fw inch	D	C	dyn. Cr	stat. Cor	nc r/min
SCE1916	/	0.043	1.187	1.500	1.000	33	57	9 300
SCE208	BCE208	0.022	1.250	1.500	0.500	13.5	22.2	8 800
SCE2010	BCE2010	0.030	1.250	1.500	0.625	16.5	29	8 800
SCE2012	BCE2012	0.037	1.250	1.500	0.750	21.1	39.5	8 800
SCE2016	BCE2016	0.045	1.250	1.500	1.000	27	55	8 800
SCE2020	BCE2020	0.056	1.250	1.500	1.250	33.5	71	8 800
SCH208	BCH208	0.036	1.250	1.625	0.500	16.4	21	8 800
SCH2012	BCH2012	0.062	1.250	1.625	0.750	27.1	39.5	8 800
SCH2016	BCH2016	0.071	1.250	1.625	1.000	36	57.5	8 800
SCH2020	BCH2020	0.079	1.250	1.625	1.250	43.6	72.9	8 800
SCE2110	/	0.037	1.313	1.625	0.625	21.1	34	8 400
SCE228	BCE228	0.025	1.375	1.625	0.500	13.6	23.7	8 000
SCE2212	BCE2212	0.039	1.375	1.625	0.750	21.5	42.5	8 000
SCE2216	/	0.058	1.375	1.625	1.000	27.5	59	8 000
SCE2220	BCE2220	0.081	1.375	1.625	1.250	34	77	8 000
SCH2212	BCH2212	0.057	1.375	1.750	0.750	29.5	45	8 000
SCH2216	BCH2216	0.077	1.375	1.750	1.000	39	65	8 000
SCE248	BCE248	0.048	1.500	1.875	0.500	18.6	26	7 400

caged type drawn cup needle bearings

Series SCE/SCH

Series BCE/BCH



SCE,SCH

BCE,BCH

With open ends Shaft diameter	With closed ends Designation	Weight ≈ kg	Dimensions			Basic radial load(kN)		Limiting speed n _g r/min
			F _w inch	D	C	dyn. C _r	stat. C _{0r}	
SCE166	BCE166	0.018	1.000	1.250	0.375	7.8	10.2	11 000
SCE168	BCE168	0.019	1.000	1.250	0.500	12.6	19.1	11 000
SCE1612	BCE1612	0.027	1.000	1.250	0.750	18.5	31.5	11 000
SCE1616	BCE1616	0.038	1.000	1.250	1.000	24.8	45.5	11 000
SCH1610	BCH1610	0.035	1.000	1.313	0.625	16.7	22.7	11 000
SCH1612	BCH1612	0.036	1.000	1.313	0.750	20	28.5	11 000
SCH1616	BCH1616	0.047	1.000	1.313	1.000	28.9	46.3	11 000
SCE186	BCE186	0.019	1.125	1.375	0.375	8.3	11.5	9 800
SCE188	BCE188	0.021	1.125	1.375	0.500	12.8	20.2	9 800
SCE1812	BCE1812	0.030	1.125	1.375	0.750	18.9	34	9 800
SCE1816	BCE1816	0.040	1.125	1.375	1.000	26	49.5	9 800
SCH1810	BCH1810	0.043	1.125	1.500	0.625	21.8	29	9 800
SCH1812	BCH1812	0.048	1.125	1.500	0.750	25	35	9 800
SCH1816	BCH1816	0.063	1.125	1.500	1.000	31.5	46.5	9 800
SCH1818	BCH1818	0.085	1.125	1.500	1.125	40.5	65	9 800
SCH1820	BCH1820	0.055	1.125	1.500	1.250	40.9	64.5	9 800

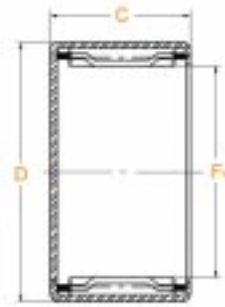

SCE, SCH

BCE, BCH

With open ends Shaft diameter	With closed ends Designation	Weight ≈ kg	Dimensions			Basic radial load(kN)		Limiting speed n _s r/min
			F _w inch	D	C	dyn. C _r	stat. C _{0r}	
SCE248	BCE248	0.048	1.500	1.875	0.500	18.6	26	7 400
SCE2410	BCE2410	0.054	1.500	1.875	0.625	24.4	36.5	7 400
SCE2412	BCE2412	0.062	1.500	1.875	0.750	30.5	48.5	7 400
SCE2414	BCE2414	0.072	1.500	1.875	0.875	36	60	7 400
SCE2416	BCE2416	0.083	1.500	1.875	1.000	38.5	66	7 400
SCE2420	BCE2420	0.105	1.500	1.875	1.250	47.5	86	7 400
SCE2610	BCE2610	0.055	1.625	2.000	0.625	25.5	40	6 800
SCE2620	BCE2620	0.110	1.625	2.000	1.250	51	97	6 800
SCE2812	BCE2812	0.082	1.750	2.125	0.750	31.5	55	6 300
SCE2816	SCE2816	0.115	1.750	2.125	1.000	41.5	76	6 300
SCE2820	/	0.134	1.750	2.125	1.250	55	108	6 300
SCE2824	BCE2824	0.163	1.750	2.125	1.500	62	130	6 300
SCE328	/	0.058	2.000	2.375	0.500	21.8	35	5 500
SCE3210	/	0.068	2.000	2.375	0.625	28.5	49.5	5 500
SCE3216	BCE3216	0.102	2.000	2.375	1.000	41.5	80	5 500
SCE3220	/	0.138	2.000	2.375	1.250	55	116	5 500

axial needle roller and cage assemblies washers

AXK
Series AS

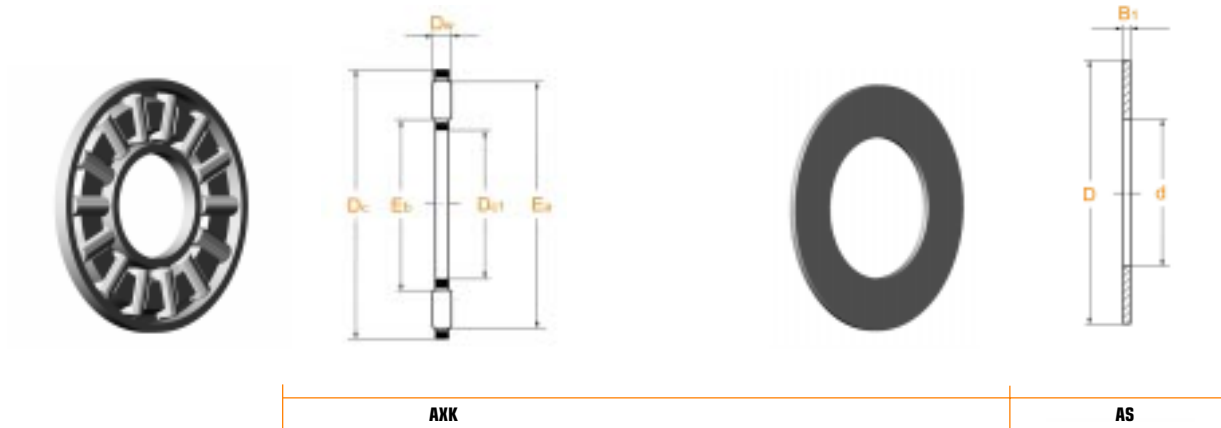

Shaft diameter	Axial needle roller and cage assembly		Axial bearing washer		Dimensions				Raceway dimensions		Basic radial load(kN)		Fatigue load	Limiting speed	Reference speed
	Designation	Weight ≈ kg	Designation	Weight ≈ kg	Dc1 mm	Dc	Dw	B1	Eb	Ea Cr	dyn. Ccr	stat. kN	Pa r/min	Pe r/min	Ps
4	AXK 0414 TN	0.0007	AS0414	0.001	4	14	2	1	5	13	4.4	8	0.61	21 000	11 000
5	AXK 0515 TN	0.0008	AS0515	0.001	5	15	2	1	6	14	4.75	9.2	0.72	21 000	9 500
6	AXK 0619 TN	0.001	AS0619	0.002	6	19	2	1	7	18	6.8	15.5	1.57	19 000	8 000
8	AXK 0821 TN	0.002	AS0821	0.002	8	21	2	1	9	20	7.8	19.4	2.02	18 000	6 500
10	AXK 1024	0.003	AS 1024	0.003	10	24	2	1	12	23	9.2	25.5	2.65	17 000	5 500
12	AXK 1226	0.003	AS 1226	0.003	12	26	2	1	14	25	9.9	29	3.05	15 000	4 700
15	AXK 1528	0.004	AS 1528	0.003	15	28	2	1	17	27	11.3	36	3.9	13 000	3 600
17	AXK 1730	0.004	AS 1730	0.004	17	30	2	1	19	29	11.9	39.5	4.35	12 000	3 200
20	AXK 2035	0.005	AS 2035	0.005	20	35	2	1	22	34	13.1	46.5	5.2	10 000	3 100
25	AXK 2542	0.007	AS 2542	0.007	25	42	2	1	29	41	14.7	58	6.5	8 500	2 800
30	AXK 3047	0.008	AS 3047	0.008	30	47	2	1	34	46	16.3	70	7.9	7 500	2 300
35	AXK 3552	0.010	AS 3552	0.009	35	52	2	1	39	51	17.8	81	9.3	6 500	2 000
40	AXK 4060	0.016	AS 4060	0.012	40	60	3	1	45	58	28	114	12.6	6 000	1 700
45	AXK 4565	0.018	AS 4565	0.013	45	65	3	1	50	63	30	128	14.3	5 000	1 500
50	AXK 5070	0.020	AS 5070	0.014	50	70	3	1	55	68	32	143	16	4 800	1 400

TN = plastic cages, the allowed max working temperature +120 (continues running)

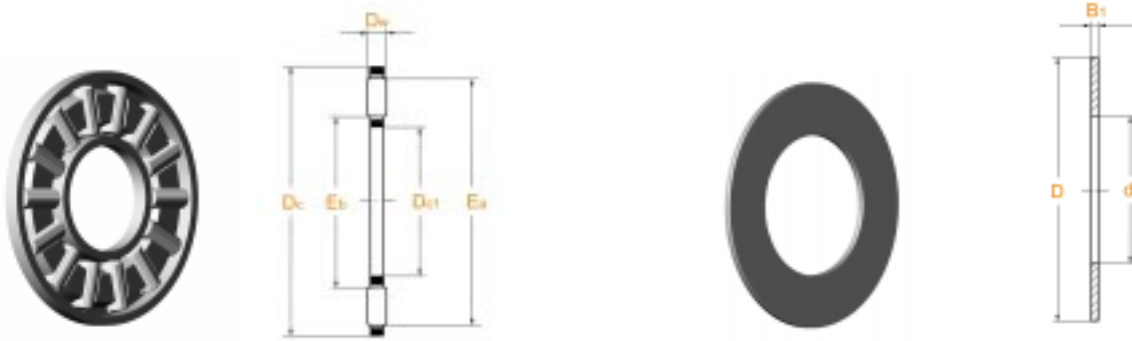

AXK

AS

Shaft diameter	Axial needle roller and cage assembly		Axial bearing washer		Dimensions				Raceway dimensions		Basic radial load(kN)		Fatigue load	Limiting speed	Reference speed
	Designation	Weight ≈ kg	Designation	Weight ≈ kg	Dc1 mm	Dc	Dw	B1	Eb	Ea Cr	dyn. Cor	stat. kN	Pa r/min	nc r/min	ns
55	AXK 5578	0.028	AS 5578	0.018	55	78	3	1	60	76	38	186	21.6	4 300	1 200
60	AXK 6085	0.033	AS 6085	0.022	60	85	3	1	65	83	44.5	234	28.5	4 000	1 100
65	AXK 6590	0.035	AS 6590	0.024	65	90	3	1	70	88	46.5	255	31	3 700	1 000
70	AXK 7095	0.060	AS 7095	0.025	70	95	4	1	74	93	54	255	30	3 500	1 000
75	AXK 75100	0.061	AS 75100	0.027	75	100	4	1	79	98	55	265	31.5	3 300	950
80	AXK 80105	0.063	AS 80105	0.028	80	105	4	1	84	103	56	280	33	3 100	900
85	AXK 85110	0.067	AS 85110	0.029	85	110	4	1	89	108	58	290	34.5	3 000	850
90	AXK 90120	0.086	AS 90120	0.039	90	120	4	1	94	118	73	405	50	2 700	750
100	AXK 100135	0.104	AS 100135	0.050	100	135	4	1	105	133	91	560	63	2 500	650
110	AXK 110145	0.122	AS 110145	0.055	110	145	4	1	115	143	97	620	69	2 300	600
120	AXK 120155	0.131	AS 120155	0.059	120	155	4	1	125	153	102	680	74	2 100	550
130	AXK 130170	0.205	AS 130170	0.065	130	170	5	1	136	167	133	840	84	1 900	500
140	AXK 140180	0.219	AS 140180	0.079	140	180	5	1	146	177	138	900	88	1 800	480
150	AXK 150190	0.232	AS 150190	0.084	150	190	5	1	156	187	143	960	92	1 700	440
160	AXK 160200	0.246	AS 160200	0.089	160	200	5	1	166	197	148	1020	97	1 600	420

TN = plastic cages, the allowed max working temperature +120 (continues running)

thrust needle roller and cage assemblies washers

Series NTA
Series TRA/C/D

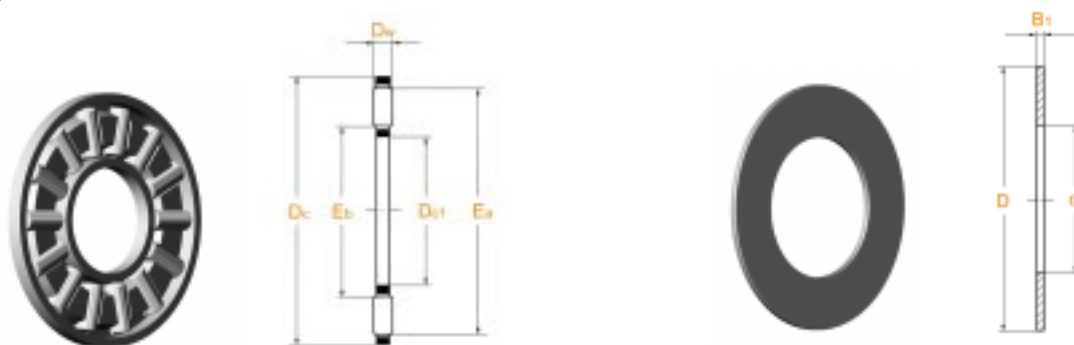

NTA

TRA/C/D

Axial needle roller and cage assembly Designation	Axial bearing washer Designation	Dimensions					Raceway dimensions		Basic radial load(kN)		Fatigue load Nc r/min
		Dc1 inch	Dc (D)	Dw	B1 min. max.		Eb	Ea	dyn. Cr	stat. Cor	
NTA 411	TRA 411	0.250	0.687	0.0781	0.030	0.032	0.34	0.58	0.925	2.060	28 000
	TRC 411	0.250	0.687	0.0781	0.092	0.095	0.34	0.58	0.925	2.060	28 000
NTA 512	TRA 512	0.312	0.750	0.0781	0.030	0.032	0.40	0.64	1.050	2.510	25 000
NTA 613	TRA 613	0.375	0.812	0.0781	0.030	0.032	0.46	0.71	1.090	2.740	23 000
	TRC 613	0.375	0.812	0.0781	0.092	0.095	0.46	0.71	1.090	2.740	23 000
NTA 815	TRA 815	0.500	0.937	0.0781	0.030	0.032	0.59	0.83	1.290	3.660	19 000
	TRC 815	0.500	0.937	0.0781	0.092	0.095	0.59	0.83	1.290	3.660	19 000
NTA 916	TRA 916	0.562	1.000	0.0781	0.030	0.032	0.65	0.89	1.390	4.110	18 000
	TRC 916	0.562	1.000	0.0781	0.092	0.095	0.65	0.89	1.390	4.110	18 000
NTA 1018	TRA 1018	0.625	1.125	0.0781	0.030	0.032	0.71	1.02	1.590	5.070	16 000
	TRC 1018	0.625	1.125	0.0781	0.092	0.095	0.71	1.02	1.590	5.070	16 000
	TRD 1018	0.625	1.125	0.0781	0.123	0.126	0.71	1.02	1.590	5.070	16 000
NTA 1220	TRA 1220	0.750	1.250	0.0781	0.030	0.032	0.84	1.14	1.770	6.090	14 000
	TRC 1220	0.750	1.250	0.0781	0.092	0.095	0.84	1.14	1.770	6.090	14 000
	TRD 1220	0.750	1.250	0.0781	0.123	0.126	0.84	1.14	1.770	6.090	14 000
NTA 1423	TRA 1423	0.875	1.437	0.0781	0.030	0.032	0.96	1.33	2.350	9.210	12 000
	TRC 1423	0.875	1.437	0.0781	0.092	0.095	0.96	1.33	2.350	9.210	12 000
	TRD 1423	0.875	1.437	0.0781	0.123	0.126	0.96	1.33	2.350	9.210	12 000
NTA 1625	TRA 1625	1.000	1.562	0.0781	0.030	0.032	1.09	1.45	2.420	9.870	11 000
	TRC 1625	1.000	1.562	0.0781	0.092	0.095	1.09	1.45	2.420	9.870	11 000
	TRD 1625	1.000	1.562	0.0781	0.123	0.126	1.09	1.45	2.420	9.870	11 000
NTA 1828	TRA 1828	1.125	1.750	0.0781	0.030	0.032	1.21	1.64	3.040	13.700	9 800
	TRC 1828	1.125	1.750	0.0781	0.092	0.095	1.21	1.64	3.040	13.700	9 800
	TRD 1828	1.125	1.750	0.0781	0.123	0.126	1.21	1.64	3.040	13.700	9 800

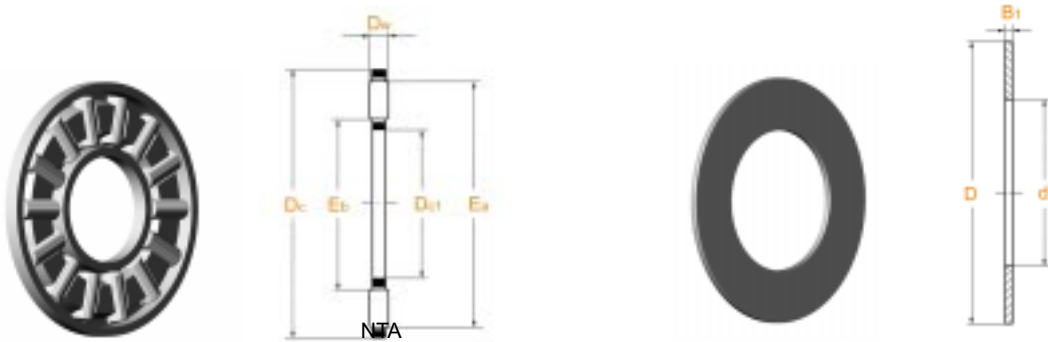

	NTA	TRA/C/D
--	-----	---------

Axial needle roller and cage assembly Designation	Axial bearing washer Designation	Dimensions					Raceway dimensions		Basic radial load(kN)		Fatigue load nc r/min
		Dc1 inch	Dc (D)	Dw	B1 min. max.		Eb	Ea	dyn. Cr	stat. Cor	
NTA 2031	TRA 2031	1.250	1.937	0.0781	0.030	0.032	1.34	1.82	3.690	18.200	8 800
	TRC 2031	1.250	1.937	0.0781	0.092	0.095	1.34	1.82	3.690	18.200	8 800
	TRD 2031	1.250	1.937	0.0781	0.123	0.126	1.34	1.82	3.690	18.200	8 800
NTA 2233	TRA 2233	1.375	2.062	0.0781	0.030	0.032	1.46	1.95	3.910	20.100	8 200
	TRC 2233	1.375	2.062	0.0781	0.092	0.095	1.46	1.95	3.910	20.100	8 200
	TRD 2233	1.375	2.062	0.0781	0.123	0.126	1.46	1.95	3.910	20.100	8 200
NTA 2435	TRA 2435	1.500	2.187	0.0781	0.030	0.032	1.59	2.07	4.250	23.000	7 700
	TRC 2435	1.500	2.187	0.0781	0.092	0.095	1.59	2.07	4.250	23.000	7 700
	TRD 2435	1.500	2.187	0.0781	0.123	0.126	1.59	2.07	4.250	23.000	7 700
NTA 2840	TRA 2840	1.750	2.500	0.0781	0.030	0.032	1.84	2.32	4.640	26.900	6 900
	TRC 2840	1.750	2.500	0.0781	0.092	0.095	1.84	2.32	4.640	26.900	6 900
	TRD 2840	1.750	2.500	0.0781	0.123	0.126	1.84	2.32	4.640	26.900	6 900
NTA 3244	TRA 3244	2.000	2.750	0.0781	0.030	0.032	2.09	2.57	4.400	25.900	6 200
	TRC 3244	2.000	2.750	0.0781	0.092	0.095	2.09	2.57	4.400	25.900	6 200
	TRD 3244	2.000	2.750	0.0781	0.123	0.126	2.09	2.57	4.400	25.900	6 200
NTA 3446	TRA 3446	2.125	2.875	0.0781	0.030	0.032	2.22	2.70	4.470	26.900	5 900
	TRC 3446	2.125	2.875	0.0781	0.092	0.095	2.22	2.70	4.470	26.900	5 900
	TRD 3446	2.125	2.875	0.0781	0.123	0.126	2.22	2.70	4.470	26.900	5 900
NTA 3648	TRA 3648	2.250	3.000	0.0781	0.030	0.032	2.34	2.82	4.540	27.800	5 700
	TRC 3648	2.250	3.000	0.0781	0.092	0.095	2.34	2.82	4.540	27.800	5 700
	TRD 3648	2.250	3.000	0.0781	0.123	0.126	2.34	2.82	4.540	27.800	5 700

drawn cup roller clutches

Series HF

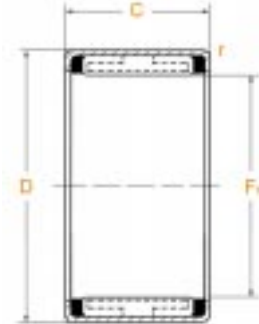

Shaft diameter	Designation	Weight ≈ kg	Dimensions				Permissible torque M_{perm} Nm	Speed limit ¹⁾		Suitable drawn cup needle roller bearings ⁴⁾
			Fw mm	D	C -0,3	r min.		$n_{GW}^{2)}$ r/min	$n_{GA}^{3)}$ r/min	
6	HF 0612	0.003	6	10	12	0,3	1.76	23 000	13 000	HK 0608
8	HF 0812	0.0035	8	12	12	0,3	3.15	17 000	12 000	HK 0808
10	HF 1012	0.004	10	14	12	0,3	5.3	14 000	11 000	HK 1010
12	HF 1216	0.011	12	18	16	0,3	12.2	11 000	8 000	HK 1212
14	HF 1416	0.013	14	20	16	0,3	17.3	9 500	8 000	HK 1412
16	HF 1616	0.014	16	22	16	0,3	20.5	8 500	7 500	HK 1612
18	HF 1816	0.016	18	24	16	0,3	24.1	7 500	7 500	HK 1812
20	HF 2016	0.017	20	26	16	0,3	28.5	7 000	6 500	HK 2010
25	HF 2520	0.030	25	32	20	0,3	66	5 500	5 500	HK 2512
30	HF 3020	0.036	30	37	20	0,3	90	4 500	4 500	HK 3012
35	HF 3520	0.040	35	42	20	0,3	121	3 900	3 900	HK 3512

¹⁾ limit speed for oil lubrication and grease lubrication

²⁾ limit rotation speed of the shaft

³⁾ limit rotation speed of the rotating outer ring

⁴⁾ see page 52, 53, 54, 55, 56 and 57 for other inner rings

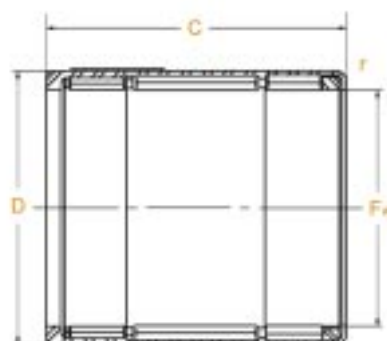
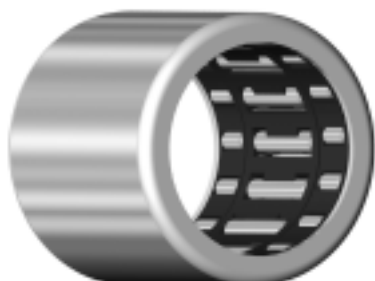

Shaft diameter	Designation	Weight ≈ kg	Dimensions				Permissible torque M_{perm} Nm	Speed limit ¹⁾		Basic radial load(kN)		Fatigue load P_u kN
			Fw mm	D mm	C -0,3	r min.		$n_{GW}^2)$ r/min	$n_{GR}^2)$ r/min	dyn. Cr	stat. Cor	
8	HFL 0822	0.007	8	12	22	0,3	3.15	17 000	12 000	3.5	4.1	0.405
10	HFL 1022	0.008	10	14	22	0,3	5.3	14 000	11 000	3.75	4.65	0.46
12	HFL 1226	0.018	12	18	26	0,3	12.2	11 000	8 000	5.8	6.7	0.62
14	HFL 1426	0.020	14	20	26	0,3	17.3	9 500	8 000	6.3	7.8	0.73
16	HFL 1626	0.022	16	22	26	0,3	20.5	8 500	7 500	6.9	9	0.84
18	HFL 1826	0.025	18	24	26	0,3	24.1	7 500	7 500	7.4	10.2	0.95
20	HFL 2026	0.027	20	26	26	0,3	28.5	7 000	6 500	7.9	11.4	1.06
25	HFL 2530	0.044	25	32	30	0,3	66	5 500	5 500	9.8	14	1.19
30	HFL 3030	0.051	30	37	30	0,3	90	4 500	4 500	10.8	16.9	1.42
35	HFL 3530	0.058	35	42	30	0,3	121	3 900	3 900	11.4	18.8	1.6

¹⁾ limit speed for oil lubrication and grease lubrication

²⁾ limit rotation speed of the shaft

³⁾ limit rotation speed of the rotating outer ring

⁴⁾ see page 52, 53, 54, 55, 56 and 57 for other inner rings

drawn cup roller clutches

Series RC

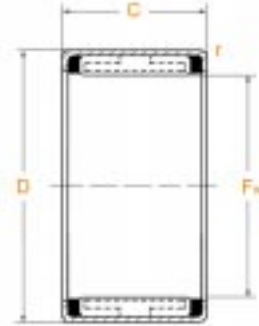

Shaft diameter	Dimensions				Permissible torque M_{perm} Nm	Speed limit ¹⁾		Weight ≈ kg
	F_w inch	D	C	r min.		n_{GW^2} r/min	n_{GA^2} r/min	
RC 040708	0.25	0.438	0.5	0,3	2.1	21 000	12 000	0.004
RC 061008	0.375	0.625	0.5	0,3	5.7	14 000	12 000	0.0097
RC 081208	0.5	0.75	0.5	0,3	9.7	11 000	9 000	0.0097
RC 101410	0.625	0.875	0.625	0,3	19.8	8 500	5 000	0.015
RC 162110	1	1.313	0.625	0,3	50	5 000	3 000	0.030

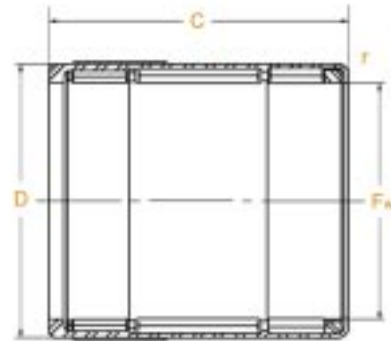
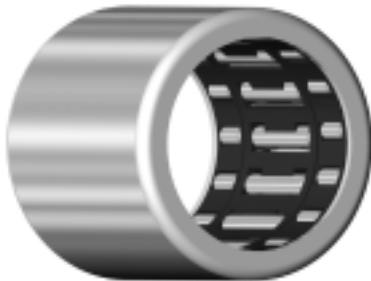

Shaft diameter	Dimensions				Permissible torque M_{perm} Nm	Speed limit ¹⁾		Weight ≈ kg
	F_w inch	D	C	r min.		$n_{GW}^{(2)}$ r/min	$n_{GA}^{(2)}$ r/min	
RCB 061014	0.375	0.625	0.875	0,3	5.7	14 000	12 000	0.014
RCB 081214	0.5	0.75	0.875	0,3	9.7	11 000	9 000	0.017
RCB 101416	0.625	0.875	1	0,3	19.8	8 500	5 000	0.023

full complement drawn cup needle bearings

Series B/BH

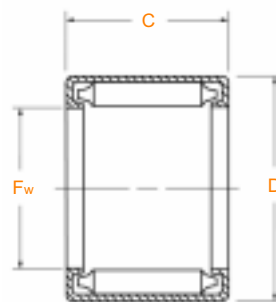

Shaft diameter	Dimensions Fw inch	D	C +0.000 -0.010	Basic radial load(kN)		Speed limit n ₆ r/min
				dyn. (C _r)	stat. (C _{0r})	
				lbf	lbf	
B 65	0.3750	0.5625	0.312	984	1 180	7 100
B 66	0.3750	0.5625	0.375	1 280	1 650	7 100
B 67	0.3750	0.5625	0.438	1 550	2 120	7 100
B 68	0.3750	0.5625	0.500	1 810	2 590	7 100
B 69	0.3750	0.5625	0.562	2 070	3 070	7 100
B 610	0.3750	0.5625	0.625	2 310	3 530	7 100
BH 68	0.3750	0.6250	0.500	2 050	2 380	9 400
B 76	0.4375	0.6250	0.375	1 390	1 930	6 300
B 77	0.4375	0.6250	0.438	1 700	2 480	6 300
B 78	0.4375	0.6250	0.500	1 980	3 030	6 300
B 710	0.4375	0.6250	0.625	2 520	4 130	6 300
BH 78	0.4375	0.6875	0.500	2 260	2 780	8 300
B 85	0.5000	0.6875	0.312	1 160	1 580	5 500
B 86	0.5000	0.6875	0.375	1 500	2 200	5 500
B 87	0.5000	0.6875	0.438	1 830	2 840	5 500
B 88	0.5000	0.6875	0.500	2 130	3 460	5 500
B 810	0.5000	0.6875	0.625	2 720	4 720	5 500
B 812	0.5000	0.6875	0.750	3 260	5 980	5 500
BH 87	0.5000	0.7500	0.438	2 060	2 550	7 500
BH 88	0.5000	0.7500	0.500	2 450	3 180	7 500
BH 810	0.5000	0.7500	0.625	3 180	4 440	7 500
BH-812	0.5000	0.7500	0.750	3 580	5 690	7 500
B 95	0.5625	0.7500	0.312	1 240	1 780	5 000
B 96	0.5625	0.7500	0.375	1 600	2 480	5 000
B 97	0.5625	0.7500	0.438	1 950	3 190	5 000
B 98	0.5625	0.7500	0.500	2 280	3 900	5 000
B 910	0.5625	0.7500	0.625	2 900	5 310	5 000
B 912	0.5625	0.7500	0.750	3 480	6 730	5 000
BH 98	0.5625	0.8125	0.500	2 630	3 850	6 800
BH 910	0.5625	0.8125	0.625	3 400	5 000	6 800
BH 912	0.5625	0.8125	0.750	4 130	6 410	6 800
B 105	0.6250	0.8125	0.312	1 310	1 980	4 500
B 107	0.6250	0.8125	0.438	2 070	3 550	4 500

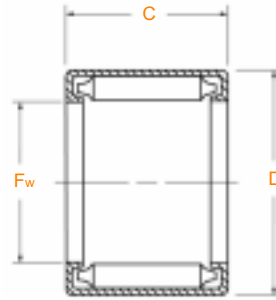

Shaft diameter	Dimensions Fw inch	D	C +0.000 -0.010	Basic radial load(kN)		Speed limit ng r/min
				dyn. (Cr)	stat. (Co-r)	
				lbf	lbf	
B 108	0.6250	0.8125	0.500	2 410	4 330	4 500
B 1010	0.6250	0.8125	0.625	3 070	5 900	4 500
B 1012	0.6250	0.8125	0.750	3 690	7 480	4 500
BH 108	0.6250	0.8750	0.500	2 790	3 980	4 500
BH 1010	0.6250	0.8750	0.625	3 620	5 530	4 500
BH 1012	0.6250	0.8750	0.750	4 390	7 130	6 200
BH 1016	0.6250	0.8750	1.000	5 830	10 300	6 200
B 116	0.6875	0.8750	0.375	1 790	3 030	6 200
B 118	0.6875	0.8750	0.500	2 540	4 770	6 200
B 1110	0.6875	0.8750	0.625	3 230	6 500	4 200
B 1112	0.6875	0.8750	0.750	3 880	8 230	4 200
BH 117	0.6875	0.9375	0.438	2 480	3 510	4 200
BH 1110	0.6875	0.9375	0.625	3 820	6 110	4 200
BH 1112	0.6875	0.9375	0.750	4 640	7 840	5 700
B 126	0.7500	1.0000	0.375	2 100	2 900	5 700
B 128	0.7500	1.0000	0.500	3 100	4 790	5 700
B 1210	0.7500	1.0000	0.625	4 010	6 670	5 500
B 1212	0.7500	1.0000	0.750	4 870	8 560	5 500
B 136	0.8125	1.0625	0.375	2 190	3 140	5 500
B 138	0.8125	1.0625	0.500	3 240	5 190	5 500
B 1314	0.8125	1.0625	0.875	5 940	11 300	5 200
B 1316	0.8125	1.0625	1.000	6 760	13 400	5 200
BH 1310	0.8125	1.1250	0.625	4 320	6 510	5 200
BH 1312	0.8125	1.1250	0.750	5 340	8 550	5 200
B 146	0.8750	1.1250	0.375	2 280	3 380	6 200
B 148	0.8750	1.1250	0.500	3 370	5 590	6 200
B 1412	0.8750	1.1250	0.750	5 300	9 990	4 800
B 1416	0.8750	1.1250	1.000	7 040	14 400	4 800
B 1418	0.8750	1.1250	1.125	7 860	16 600	4 800
BH 1410	0.8750	1.1875	0.625	4 470	7 030	5 880
BH 1412	0.8750	1.1875	0.750	5 530	9 230	5 880
BH 1416	0.8750	1.1875	1.000	7 480	13 600	5 880
B 158	0.9375	1.1875	0.500	3 500	5 990	4 500

full complement drawn cup needle bearings –inch

Series B/BH

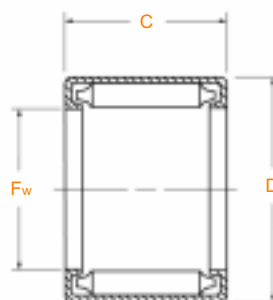

Shaft diameter	Dimensions			Basic radial load(kN)		Speed limit n ₆ r/min
	F _w inch	D	C <small>+0.000 -0.010</small>	dyn. (C _r) lbf	stat. (C _{0r}) lbf	
B 1516	0.9375	1.1875	1.000	7 300	15 400	4 500
B 166	1.0000	1.2500	0.375	2 450	3 870	4 300
B 167	1.0000	1.2500	0.438	3 050	5 120	4 300
B 168	1.0000	1.2500	0.500	3 620	6 390	4 300
B 1610	1.0000	1.2500	0.625	4 690	8 910	4 300
B 1612	1.0000	1.2500	0.750	5 690	11 400	4 300
B 1616	1.0000	1.2500	1.000	7 560	16 500	4 300
BH 168	1.0000	1.3125	0.500	3 600	5 500	5 200
BH 1610	1.0000	1.3125	0.625	4 830	8 020	5 200
BH 1612	1.0000	1.3125	0.750	5 970	10 500	5 200
BH 1616	1.0000	1.3125	1.000	8 090	15 600	5 200
BH 1620	1.0000	1.3125	1.250	10 100	20 600	5 200
BH 1624	1.0000	1.3125	1.500	11 900	25 600	5 200
B 1710	1.0625	1.3125	0.625	4 840	9 470	4 000
B 186	1.1250	1.3750	0.375	2 610	4 350	3 800
B 188	1.1250	1.3750	0.500	3 850	7 190	3 800
B 1812	1.1250	1.3750	0.750	6 060	12 900	3 800
B 1616	1.1250	1.3750	1.000	8 050	18 500	3 800
BH 1812	1.1250	1.5000	0.750	6 920	11 500	5 500
BH 1816	1.1250	1.5000	1.000	9 420	17 100	5 500
-	1.1250	1.5000	1.125	-	-	-
BH 1820	1.1250	1.5000	1.250	11 800	22 900	5 500
B 1916	1.1875	1.5000	1.000	8 860	18 500	4 400
B 208	1.2500	1.5000	0.500	4 080	7 990	3 500
B 2010	1.2500	1.5000	0.625	5 280	11 100	3 500
B 2012	1.2500	1.5000	0.750	6 410	14 300	3 500
B 2016	1.2500	1.5000	1.000	8 510	20 600	3 500
B 2020	1.2500	1.5000	1.250	10 500	26 900	3 500
BH 208	1.2500	1.6250	0.500	4 200	6 320	5 000
BH 2012	1.2500	1.6250	0.750	7 250	12 700	5 000
BH 2016	1.2500	1.6250	1.000	9 910	19 000	5 000
BH 2020	1.2500	1.6250	1.250	12 400	25 400	5 000

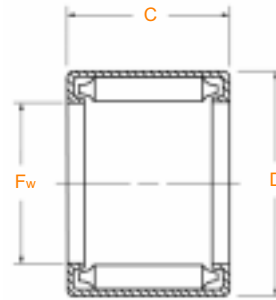

Shaft diameter	Dimensions Fw inch	D	C +0.000 -0.010	Basic radial load(kN)		Speed limit n ₆ r/min
				dyn. (C _r) lbf	stat. (C _{0r}) lbf	
B 218	1.3125	1.6250	0.500	41 800	7 220	4 000
B 2110	1.3125	1.6250	0.625	56 000	10 500	4 000
B 2120	1.3125	1.6250	1.250	11 700	27 200	4 000
B 228	1.3750	1.6250	0.500	4 280	8 790	3 200
B 2212	1.3750	1.6250	0.750	6 730	15 700	3 200
B 2216	1.3750	1.6250	1.000	8 950	22 700	3 200
B 2220	1.3750	1.6250	1.250	11 000	29 600	3 200
BH 2210	1.3750	1.7500	0.625	6 240	10 600	4 700
BH 2212	1.3750	1.7500	0.750	7 770	14 100	4 700
BH 2216	1.3750	1.7500	1.000	10 600	20 900	4 700
BH 2220	1.3750	1.7500	1.250	13 200	28 000	4 700
B 248	1.5000	1.8750	0.500	4 780	7 830	4 300
B 2410	1.5000	1.8750	0.625	6 500	11 600	4 300
B 2412	1.5000	1.8750	0.750	8 090	15 400	4 300
B 2414	1.5000	1.8750	0.875	9 590	19 200	4 300
B 2416	1.5000	1.8750	1.000	11 000	22 800	4 300
B 2420	1.5000	1.8750	1.250	13 800	30 500	4 300
B 268	1.6250	2	0.500	4 920	8 390	3 900
B 2610	1.6250	2	0.625	6 710	12 500	3 900
B 2616	1.6250	2	1.000	11 400	24 800	3 900
B 2620	1.6250	2	1.250	14 300	33 000	3 900
B 2812	1.7500	2.1250	0.750	8 660	17 900	3 700
B 2816	1.7500	2.1250	1.000	11 800	26 700	3 700
B 2820	1.7500	2.1250	1.250	14 800	35 500	3 700
B 2824	1.7500	2.1250	1.500	17 600	44 300	3 700
B 308	1.8750	2.2500	0.500	5 380	9 790	3 500
B 3012	1.8750	2.2500	0.750	9 100	19 200	3 500
B 3016	1.8750	2.2500	1.000	12 400	28 600	3 500
B 328	2	2.3750	0.500	5 490	10 300	3 300
B 3216	2	2.3750	1.000	12 700	30 500	3 300
B 3220	2	2.3750	1.250	15 900	40 600	3 300
B 3228	2	2.3750	1.750	21 800	60 700	3 300

NOTE

A series of horizontal dashed lines for writing notes.

spherical plain
bearings
rod ends



cam followers
mast bearings

bushing

ball bearings
needle bearings
inner rings

product range

europ
offices

CCVI ITALY

- Vicenza

CCVI GERMANY

- Hannover

CCVI ENGLAND

- Birmingham

CCVI SWISS

- Lugano

north
offices

CCVI USA

- Chicago

south
offices

CCVI BRASIL

- Porto Alegre

asian
offices

CCVI CHINA

- Zhenjiang

CCVI JAPAN

- Tokyo

www.ccvi.com
group@ccvi.com