



IDC® - Bearings  
by INTERPRECISE Germany

## **Full complement cylindrical roller bearings**

---

INTERPRECISE Donath GmbH  
Ostring 2  
90587 Obermichelbach  
Germany

Phone +49-911-76630-0  
Fax +49-911-76630-30

[info@interprecise.de](mailto:info@interprecise.de)  
[www.idc-bearings.com](http://www.idc-bearings.com)



## **Full complement cylindrical roller bearings**

---

### **General Information**

Full complement cylindrical roller bearings have solid inner and outer rings. By incorporating the largest possible number of rollers, they are suitable for very heavy radial loads and are space-saving at the same time. Moreover these bearings have a high rigidity.

As a consequence of higher friction between the rollers, due to their kinematic conditions, the maximum rotational speed of full complement cylindrical roller bearings is significantly lower than of caged cylindrical roller bearings.

### **Bearing Types**

As a standard, IDC® offers the full complement cylindrical roller bearings single-rowed and double-rowed. They are applicable as Floating Bearings, Support Bearings, and Locating Bearings. All bearings except Type NNF are open and can be lubricated with either oil or grease. The single row types can be lubricated through the front sides and the double row types can be lubricated through a lubrication groove or through lubrication holes. The NNF type bearings are sealed on both sides and filled with grease.

#### **Floating Bearings**

Floating Bearings have just radial load carrying capacity.

##### **Type NNCL**

The inner ring of this double row type has three fixed flanges, while the outer ring is flangeless. A retaining ring is inserted in the outer ring between the roller rows and keeps all bearing components together. Axial displacement of the shaft relative to the housing in both directions can be accommodated within the bearing. The retaining ring is not suitable for carrying axial loads.



## Support Bearings

Beside a high radial load carrying capacity, Support Bearings have also a small axial load carrying capacity in one direction, enabling the bearing to locate a shaft unidirectionally. In the other direction such bearings act as Floating Bearings.

### Type NCF

Bearings of this type are single rowed. They have an inner ring with two fixed flanges and an outer ring with just one fixed flange. On the flangeless side of the outer ring there is a retaining ring inserted, which keeps all bearing components together. This retaining ring serves solely for handling purposes and may not be exposed to axial load.

Due to the axial relocating ability of its outer ring this type of bearing is used e.g. to compensate length changes of shafts in consequence of thermal expansion. The maximum axial displacement value is shown in the dimension table.



### Type NJG

In this single row design there is only the heavy series 23. This type is mainly designed for applications with extremely high radial load at low rotational speed. Bearings of this type have one outer ring with two fixed flanges and one inner ring with only one fixed flange.

In contrast to all other full complement cylindrical roller bearings, bearings of this type have a self-retaining set of rollers by standard. Thus the rollers can not fall out even if the inner ring is removed. This simplifies the assembly significantly.



### Type NNCF

This type is a double row cylindrical roller bearing. The inner ring has three fixed flanges. The outer ring has only one fixed flange. On the flangeless side of the outer ring there is a retaining ring inserted which keeps all bearing components together.

These bearings are able to compensate for length changes of shafts as a consequence of thermal expansion within the range of the axial displacement ability of their outer ring.



## Locating Bearings

In addition to its high radial loads carrying capacity this type of bearing is also capable of carrying axial loads in both directions. This enables the bearing to guide shafts in both axial directions.

### Type NNC

The double row designed bearings of this type have an inner ring with three fixed flanges and one outer ring with two fixed flanges on the outside. A unique aspect of this is that the outer ring is axially divided in the middle. It is kept together with retaining devices. These retaining devices shall not be exposed to axial loads. Therefore the outer ring has to be supported accordingly in order to be able to carry axial loads.



### Type NNF

NNF bearings are always sealed on both sides by standard. The outer ring has a fixed middle flange and the inner ring has three fixed flanges. The inner ring is two-pieced and kept together by retaining rings, which shall not be exposed to axial loads. Therefore the inner ring has to be supported accordingly in order to be able to carry axial loads.

Since NNF bearings are used predominantly in robe sheaves and wheels the outer ring is 1mm narrower than the inner ring.

The bearings have a contact seal made from polyurethane on both sides and are retained on the inner ring shoulders to provide sufficient sealing at this position. The outer sealing lip exerts a slight pressure on the outer ring raceway. NNF bearings are filled with lithium soap grease. The operating temperature for the seals and the used grease ranges from -20°C to +80°C.

Under certain conditions, especially if operated at higher rotational speed, under higher humidity, in salt water environment, etc., the NNF bearings must be relubricated. This can be done through the inner but also through the outer ring.







## **Full complement cylindrical roller bearings**

---

### **General Bearing Data**

#### **Dimensions**

The boundary dimensions of the full complement cylindrical roller bearings comply with DIN 616 and ISO 15 respectively. In case of the double row cylindrical roller bearing series 48 and 49 the dimension specifications according to DIN 5412-9 are met. However, NNF type bearings are excluded hereof.

#### **Operating Temperature**

By standard full complement cylindrical roller bearings are suitable for operating temperatures from  $-30^{\circ}\text{C}$  to  $+120^{\circ}\text{C}$ . On request these bearings can be delivered heat-stabilized.

Restricted by the grease and the seal material NNF bearings are suitable for operating temperatures from  $-20^{\circ}\text{C}$  to  $+80^{\circ}\text{C}$ .

#### **Heat Treatment Process**

Rings and rollers are fully hardened by standard. On request the bearings can be offered with bainite or case hardened components.

#### **Surface**

By standard rings and rollers are uncoated. On request anti-corrosion or friction reduction coatings are possible.

#### **Misalignment**

With single row full complement cylindrical roller bearings a maximum misalignment between the inner ring and the outer ring of 2 minutes of arc has no impact on the life time of the bearing.

Double row full complement cylindrical roller bearings are not able to absorb a misalignment.

#### **Tolerances**

By default full complement cylindrical roller bearings are produced to Tolerance Class PN according to DIN 620-2 and ISO 492 respectively. On request the bearings can be produced in other tolerance classes as well.

## Internal Clearance

The radial internal clearance of the full complement cylindrical roller bearings corresponds to Internal Clearance Group CN according to DIN 620-4 and ISO 5753 respectively. On request the bearings can be produced with other internal clearance as well.

Bore d [mm]		Radial Internal Clearance [ $\mu\text{m}$ ]							
		CN		C3		C4		C5	
over	incl.	min	max	min	max	min	max	min	max
-	24	20	45	35	60	50	75	65	90
24	30	20	45	35	60	50	75	70	95
30	40	25	50	45	70	60	85	80	105
40	50	30	60	50	80	70	100	95	125
50	65	40	70	60	90	80	110	110	140
65	80	40	75	65	100	90	125	130	165
80	100	50	85	75	110	105	140	155	190
100	120	50	90	85	125	125	165	180	220
120	140	60	105	100	145	145	190	200	245
140	160	70	120	115	165	165	215	225	275
160	180	75	125	120	170	170	220	250	300
180	200	90	145	140	195	195	250	275	330
200	225	105	165	160	220	220	280	305	365
225	250	110	175	170	235	235	300	330	395
250	280	125	195	190	260	260	330	370	440
280	315	130	205	200	275	275	350	410	485
315	355	145	225	225	305	305	385	455	535
355	400	190	280	280	370	370	460	510	600
400	450	210	310	310	410	410	510	565	665
450	500	220	330	330	440	440	550	625	735
500	560	240	360	360	480	480	600	690	810
560	630	260	380	380	500	500	620	780	900
630	710	285	425	425	565	565	705	865	1005
710	800	310	470	470	630	630	790	975	1135
800	900	350	520	520	690	690	860	1095	1265
900	1000	390	580	580	770	770	960	1215	1405
1000	1120	430	640	640	850	850	1060	1355	1565
1120	1250	470	710	710	950	950	1190	1510	1750
1250	1400	530	790	790	1050	1050	1310	1680	1940

## Axial Displacement

Depending on the respective series with full complement cylindrical roller bearings the outer ring's axial displacement relative to the inner ring in one or in both directions can be accommodated within the bearing. However, Locating Bearings are excluded. The values for the axial displacement are shown in the respective product table.

## Minimum Radial Load

With full complement cylindrical roller bearings a minimum radial load of 4% of the dynamic load rating is needed in order to ensure a failure-free operation.

## Equivalent Dynamic Bearing Load

In case of solely radial load acting on a full complement cylindrical roller bearing the dynamic load is calculated from the following equation:

$$P = F_r$$

In case full complement cylindrical roller bearings are subject to a simultaneously acting axial load the following calculation applies:

$$\frac{F_a}{F_r} \leq e \quad P = F_r$$

$$\frac{F_a}{F_r} > e \quad P = X * F_r + Y * F_a$$

Explanation:

- e limiting value  
0.15 for all double row full complement cylindrical roller bearings  
0.2 for all bearings of series 18  
0.3 for all other single row full complement cylindrical roller bearings
- X 0.92 = radial load factor for all full complement cylindrical roller bearings
- Y axial load factor  
0.6 for all bearings of series 18  
0.4 for all other single row full complement cylindrical roller bearings  
0.53 for all double row full complement cylindrical roller bearings

In order to ensure an acceptable run of the bearing the following ratios must not be exceeded:

- single row bearings:  $F_a/F_r = 0.50$
- double row bearings:  $F_a/F_r = 0.25$

## Equivalent Static Bearing Load

In case full complement cylindrical roller bearings are exposed to static load the following calculation applies:

$$P_0 = F_r$$

## Axial Load Carrying Capacity

Full complement cylindrical roller bearings which are designed as Supporting or Locating Bearings can also accommodate axial loads. The axial load carrying capacity, however, is primarily not dependent on the material strength but rather on:

- the load carrying capacity of the sliding surfaces on the face area of the rollers and the ribs
- the lubrication of the contact areas

On basis of the following equation and parameters the permissible, permanently acting axial load can be calculated with sufficient accuracy from:

$$F_{azul} = \frac{k_1 * C_0 * 10^4}{n * (d + D)} - k_2 * F_r$$

Explanation:

$F_{azul}$	highest permissible, permanently acting axial load [kN]
$C_0$	basic static load rating [kN]
$F_r$	actual radial load [kN]
$n$	rotational speed [r/min]
$d$	bearing bore diameter [mm]
$D$	bearing outside diameter [mm]
$k_1$	factor dependent on the bearing type and the lubrication method: single row bearings: 1.00 for oil lubrication 0.50 for grease lubrication double row bearings: 0.35 for oil lubrication 0.20 for grease lubrication
$k_2$	factor dependent on the bearing type and the lubrication method: single row bearings: 0.30 for oil lubrication 0.15 for grease lubrication double row bearings: 0.10 for oil lubrication 0.06 for grease lubrication

The values for  $F_{azul}$  obtained from the equation are valid for the following conditions:

- the maximum temperature difference between bearing operating temperature and environmental temperature of 60°C
- the minimum viscosity factor of 2
- the specific heat dissipation relating to the lateral area of the bearing of 0.5 mW/mm<sup>2</sup>

In case grease is used as lubricant, the viscosity of the base oil has to be considered. Viscosity factors less than 2 will result in higher wear values and friction values. In order to lower these values, oils with wear protection or with respective EP additives may be used but at lower rotational speeds.

In case of axial loads acting over a longer period of time on a bearing, which is grease-lubricated, we recommend the use of grease according to DIN 51817 with a least 3% oil separation. Frequent relubrication of the bearing is recommended as well.



In case of short period acting or alternating shock acting axial loads, the following values are valid for the permissible axial load:

short period loading:  $F_{akzul} = 2 * F_{azul}$

alternating shock loading:  $F_{aszul} = 3 * F_{azul}$

However, the above values apply provided that the following limit values for axial loads, with respect to the strength of the ribs, are not exceeded:

permanent loading:  $F_{amax} = 0.023 * D^{1.7}$

short period / occasional loading:  $F_{amax} = 0.007 * D^{1.7}$

## Radial Fastening

Normally type NNF bearings are exposed to circumferential load (e.g. with robe sheaves). For this reason the outer rings have to be located by means of interference fit in the housing.

## Axial Fastening

Bearing rings have to be located with positive contact in order to avoid the axial displacement in the close-by components (shaft and housing). In this context the recommendations according to DIN 5418 shall be considered. Recesses according to DIN 509 can also be applied. In either case the minimum chamfers according to the respective product table have to be considered.

Axially loaded ribs should be supported as possible over their overall height.

Double row type NNF bearings can be fixed by simple snap rings being put into the snap ring grooves on the outer ring. By standard these snap rings are not included, however, they can be included on request (suffix 2NR).

The sealing rings of the NNF type bearings must be sufficiently supported as well. Otherwise they are likely to be pressed out when the bearing is relubricated.

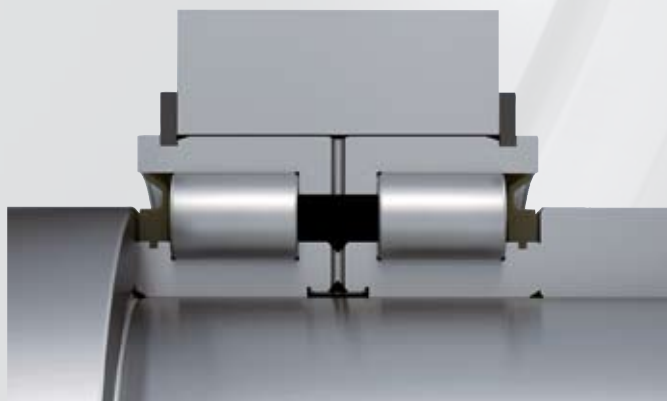

## Suffixes

This list shows suffixes for deliverable designs which differ from the standard:

2NR two separately included snap rings type WRE (bearing type NNF)<sup>\*1</sup>

BR burnished<sup>\*1</sup>

C3 radial internal clearance higher than CN<sup>\*1</sup>

C4 radial internal clearance higher than C3<sup>\*1</sup>

C5 radial internal clearance higher than C4<sup>\*1</sup>

HA1 inner ring and outer ring from case hardening steel<sup>\*1</sup>

HB1 inner ring and outer ring from bainite hardened<sup>\*1</sup>

P6 dimensional and running tolerance less than PN<sup>\*1</sup>

P5 dimensional and running tolerance less than P6<sup>\*1</sup>

PH phosphated<sup>\*1</sup>

PP sealing rings on both sides

S0 heat stabilized up to 150°C

S1 heat stabilized up to 200°C

S2 heat stabilized up to 250°C

V full complement

VH full complement, self-retaining set of rollers

ZP bearing rings with anti-corrosion coating<sup>\*1</sup>

<sup>\*1</sup>on request



**Series  
NCF 18xx.V**

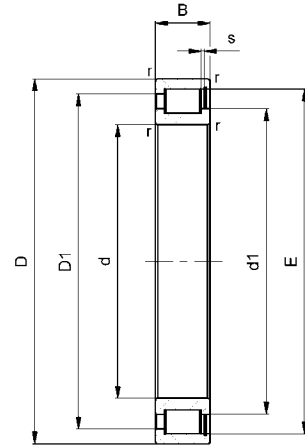

description	weight [kg]	measures [mm]								load ratings		fatigue limit load $C_{ur}$ [kN]	limiting speed $n_G$ [min <sup>-1</sup> ]
		d	D	B	r min.	E	d <sub>1</sub> ca.	D <sub>1</sub> ca.	s <sup>1)</sup>	dyn. C <sub>r</sub> [kN]	stat. C <sub>or</sub> [kN]		
NCF1830V	1,3	150	190	20	1,1	179,2	163,0	175,5	1,5	108	197	19,4	1900
NCF1832V	1,4	160	200	20	1,1	188,8	172,5	185,0	1,5	112	209	20	1800
NCF1834V	1,8	170	215	22	1,1	203,6	184,0	199,0	1,5	149	272	27,3	1700
NCF1836V	1,9	180	225	22	1,1	215,1	195,5	210,5	1,5	154	290	28,3	1600
NCF1838V	2,4	190	240	24	1,5	228,8	208,0	224,0	1,8	176	330	31,5	1500
NCF1840V	2,6	200	250	24	1,5	237,1	216,0	232,0	1,8	179	343	33	1400
NCF1844V	2,8	220	270	24	1,5	257,9	237,0	253,0	1,8	188	377	35,5	1200
NCF1848V	4,4	240	300	28	2	286,7	261,0	280,5	1,8	264	520	49,5	1100
NCF1852V	4,7	260	320	28	2	307,1	281,0	301,0	1,8	275	561	52,5	1000
NCF1856V	7,1	280	350	33	2	334,0	305,0	327,0	2,5	335	682	64	950
NCF1860V	10	300	380	38	2,1	362,9	329,0	355,0	3	428	858	79	850
NCF1864V	10,5	320	400	38	2,1	383,0	349,0	375,0	3	442	912	82	800
NCF1868V	11	340	420	38	2,1	403,1	369,0	395,0	3	455	966	86	750
NCF1872V	11,5	360	440	38	2,1	423,3	389,0	415,0	3,5	468	1020	92	700
NCF1876V	19,5	380	480	46	2,1	457,7	415,5	447,0	3,5	651	1360	122	670
NCF1880V	20,5	400	500	46	2,1	474,2	432,0	464,0	3,5	664	1420	127	630
NCF1884V	21	420	520	46	2,1	499,1	457,0	489,0	3,5	684	1500	131	600
NCF1888V	22	440	540	46	2,1	515,7	473,5	505,0	3,5	697	1560	134	560
NCF1892V	34	460	580	56	3	553,0	501,0	540,0	5	945	2020	171	530
NCF1896V	35,5	480	600	56	3	573,5	522,0	561,0	5	965	2100	180	500
NCF18/500V	36,5	500	620	56	3	594,0	542,0	581,0	5	985	2190	179	480
NCF18/530V	38,5	530	650	56	3	624,5	573,0	612,0	5	1010	2320	184	450
NCF18/560V	40,5	560	680	56	3	655,0	603,0	642,0	5	1040	2440	190	430
NCF18/600V	51,5	600	730	60	3	696,0	644,0	683,0	7	1080	2610	200	400
NCF18/630V	72,5	630	780	69	4	737,0	679,0	723,0	8	1290	3080	235	360
NCF18/670V	76,5	670	820	69	4	783,0	725,0	768,0	8	1340	3290	250	340
NCF18/710V	92,5	710	870	74	4	831,5	767,0	816,0	8	1590	3890	290	320
NCF18/750V	110	750	920	78	5	880,0	811,0	863,0	8	1790	4380	320	300
NCF18/800V	130	800	980	82	5	935,5	863,0	917,0	9	1970	4890	350	280
NCF18/850V	135	850	1030	82	5	985,5	911,0	967,0	9	2090	5290	375	260
NCF18/900V	160	900	1090	85	5	1044,0	966,0	1024,0	9	2280	5880	405	240
NCF18/950V	185	950	1150	90	5	1103,0	1022,0	1083,0	10	2490	6500	450	220
NCF18/1000V	230	1000	1220	100	6	1164,0	1074,0	1142,0	12	2980	7690	465	200

<sup>1)</sup> axial displacement facility from central position



**Series  
NCF 22xx.V**

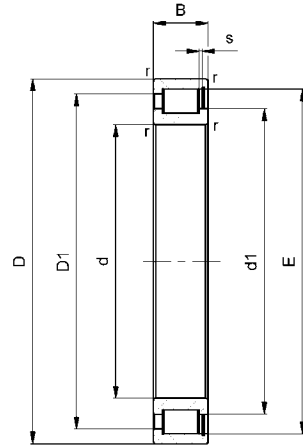

description	weight [kg]	measures [mm]								load ratings		fatigue limit load	limiting speed
		d	D	B	r min.	E	d <sub>i</sub> ca.	D <sub>1</sub> ca.	s <sup>1)</sup>	dyn. C <sub>r</sub> [kN]	stat. C <sub>or</sub> [kN]	C <sub>ur</sub> [kN]	n <sub>s</sub> [min <sup>-1</sup> ]
NCF2204V	0,16	20	47	18	1	41,6	28,7	38,3	1	40	39	5,4	9700
NCF2205V	0,18	25	52	18	1	46,6	33,8	43,4	1	45	47	6,6	8400
NCF2206V	0,30	30	62	20	1	55,2	40,8	51,6	1	61	66	8,9	7000
NCF2207V	0,44	35	72	23	1,1	64,0	46,4	59,6	1	76	81	10,5	6100
NCF2208V	0,55	40	80	23	1,1	71,0	53,4	66,6	1	84	94	13	5400
NCF2209V	0,59	45	85	23	1,1	74,5	56,9	70,1	1	87	101	13,5	5000
NCF2210V	0,64	50	90	23	1,1	81,5	63,9	77,1	1	94	114	15	4650
NCF2211V	0,87	55	100	25	1,5	88,9	69,7	84,1	1	113	141	20,5	4200
NCF2212V	1,2	60	110	28	1,5	99,3	76,8	93,6	1,5	148	184	27	3800
NCF2213V	1,6	65	120	31	1,5	106,3	82,3	100,3	1,5	172	218	32	3500
NCF2214V	1,7	70	125	31	1,5	111,1	87,1	105,1	1,5	179	232	31	3300
NCF2215V	1,8	75	130	31	1,5	115,9	91,8	109,8	1,5	185	246	32,5	3150
NCF2216V	2,1	80	140	33	2	125,9	98,7	119,1	1,5	218	286	37	2950
NCF2217V	2,7	85	150	36	2	133,3	104,5	126,5	1,5	247	329	43	2750
NCF2218V	3,5	90	160	40	2	140,7	110,3	133,5	2,5	279	376	48	2600
NCF2219V	4,2	95	170	43	2,1	155,5	121,5	147,5	2,5	327	443	55,5	2450
NCF2220V	5,1	100	180	46	2,1	162,9	127,5	154,5	2,5	371	513	63,5	2310
NCF2222V	7,2	110	200	53	2,1	177,7	139,0	168,5	4	437	613	72	2090
NCF2224V	9	120	215	58	2,1	192,5	150,5	182,5	4	519	742	88,5	1930
NCF2226V	11,2	130	230	64	3	207,4	162,5	196,5	5	603	874	101	1800
NCF2228V	14,4	140	250	68	3	222,2	174,0	210,5	5	697	1020	119	1660
NCF2230V	18,4	150	270	73	3	237,0	185,5	224,5	6	797	1190	136	1540
NCF2232V	23	160	290	80	3	266,6	209,0	252,5	6	988	1500	165	1440
NCF2234V	28,7	170	310	86	4	281,4	220,5	266,5	7	1100	1680	183	1350
NCF2236V	29,8	180	320	86	4	293,5	232,5	278,5	7	1140	1780	190	1300
NCF2238V	35,7	190	340	92	4	308,9	244,5	293,0	7	1250	1970	206	1220
NCF2240V	43,1	200	360	98	4	324,4	257,0	307,5	7	1400	2230	227	1160
NCF2244V	58	220	400	108	4	355,5	278,5	336,5	8	1690	2680	235	1100

<sup>1)</sup> axial displacement facility from central position





**Series  
NCF 29xx.V**

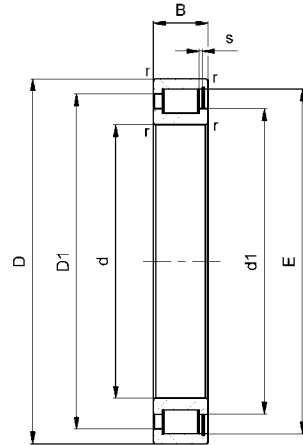

description	weight [kg]	measures [mm]								load ratings		fatigue limit load	limiting speed
		d	D	B	r min.	E	d <sub>1</sub> ca.	D <sub>1</sub> ca.	s <sup>1)</sup>	dyn. C <sub>r</sub> [kN]	stat. C <sub>0r</sub> [kN]	C <sub>0r</sub> [kN]	n <sub>6</sub> [min <sup>-1</sup> ]
NCF2904V	0,05	20	37	11	0,3	32,2	26,2	30,2	0,5	16	17	2	11000
NCF2905V	0,06	25	42	11	0,3	37,3	31,3	35,3	0,5	17	21	2,3	9600
NCF2906V	0,07	30	47	11	0,3	42,4	36,4	40,4	0,5	19	25	2,7	8300
NCF2907V	0,12	35	55	13	0,6	49,8	42,3	47,3	0,5	30	39	4,6	7100
NCF2908V	0,15	40	62	14	0,6	56,5	48,3	53,8	0,5	34	45	5,6	6300
NCF2909V	0,18	45	68	14	0,6	61,8	53,5	59,0	0,5	36	50	6	5600
NCF2910V	0,19	50	72	14	0,6	67,0	58,8	64,3	0,5	38	56	6,7	5200
NCF2911V	0,27	55	80	16	1	73,1	64,1	70,1	0,5	50	77	8,5	4800
NCF2912V	0,29	60	85	16	1	79,2	69,2	76,2	1	55	84	10,3	4500
NCF2913V	0,31	65	90	16	1	83,3	73,3	80,3	1	57	89	11,2	4000
NCF2914V	0,49	70	100	19	1	92,4	79,6	89,1	1	77	118	15,1	3800
NCF2915V	0,52	75	105	19	1	97,5	84,7	94,2	1	80	126	16,1	3600
NCF2916V	0,55	80	110	19	1	102,6	89,8	99,3	1	83	134	17,2	3400
NCF2917V	0,81	85	120	22	1,1	112,5	98,2	108,9	1	104	169	21	3200
NCF2918V	0,84	90	125	22	1,1	115,4	101,0	111,8	1	105	174	21,5	3000
NCF2919V	0,86	95	130	22	1,1	121,1	106,8	117,5	1	108	185	22	2800
NCF2920V	1,14	100	140	24	1,1	128,2	112,2	124,5	1,5	125	209	25	2600
NCF2922V	1,23	110	150	24	1,1	141,0	125,0	137,0	1,5	132	233	27,5	2400
NCF2924V	1,73	120	165	27	1,1	153,8	134,5	149,0	1,5	177	304	37,5	2200
NCF2926V	2,33	130	180	30	1,5	166,7	145,5	161,5	2	208	364	44	2000
NCF2928V	2,42	140	190	30	1,5	179,5	157,0	174,0	2	225	392	46,5	1900
NCF2930V	3,77	150	210	36	2	194,9	169,0	188,5	2,5	293	512	59	1700
NCF2932V	4	160	220	36	2	205,1	179,0	199,0	2,5	302	544	62	1600
NCF2934V	4,3	170	230	36	2	215,3	189,5	209,0	2,5	311	576	63,5	1500
NCF2936V	6,2	180	250	42	2	231,4	201,0	224,0	2,5	397	709	81,5	1400
NCF2938V	6,5	190	260	42	2	243,6	213,0	236,0	2,5	410	753	82,5	1400
NCF2940V	9,1	200	280	48	2,1	262,5	228,5	254,0	3	498	924	101	1300
NCF2944V	9,9	220	300	48	2,1	282,6	248,5	274,5	3	522	1010	108	1200
NCF2948V	10,6	240	320	48	2,1	302,7	268,5	294,5	3	544	1090	109	1100
NCF2952V	18,5	260	360	60	2,1	333,2	291,5	323,0	3,5	764	1490	150	950
NCF2956V	19,7	280	380	60	2,1	358,9	314,0	348,0	3,5	887	1750	172	900
NCF2960V	31,2	300	420	72	3	389,8	338,5	377,0	5	1130	2240	218	800
NCF2964V	32,9	320	440	72	3	410,2	358,5	397,5	5	1170	2380	228	750
NCF2968V	35	340	460	72	3	430,6	379,0	418,0	5	1210	2520	238	700
NCF2972V	36,5	360	480	72	3	451,0	399,5	438,0	5	1240	2660	250	670
NCF2976V	52,5	380	520	82	4	484,4	426,5	470,0	5	1490	3160	290	630
NCF2980V	54,5	400	540	82	4	507,5	449,5	493,0	5	1530	3330	300	600
NCF2984V	57	420	560	82	4	530,5	472,5	516,0	5	1570	3510	310	560
NCF2988V	80,5	440	600	95	4	565,0	497,5	549,0	6	2040	4480	390	530
NCF2992V	83,5	460	620	95	4	578,5	511,0	562,0	6	2070	4600	400	500
NCF2996V	98	480	650	100	5	605,5	533,0	588,0	7	2310	5110	420	480
NCF29/500V	100	500	670	100	5	634,0	561,0	616,0	7	2380	5400	440	450
NCF29/530V	120	530	710	106	5	673,0	592,0	653,0	7	2730	6080	490	430
NCF29/560V	140	560	750	112	5	709,5	622,0	688,0	7	3070	6790	500	400
NCF29/600V	170	600	800	118	5	753,5	663,0	731,0	7	3390	7690	550	380
NCF29/630V	205	630	850	128	6	807,5	711,0	783,0	8	3790	8650	620	340
NCF29/670V	245	670	900	136	6	854,0	754,0	829,0	10	4150	9690	670	320

<sup>1)</sup> axial displacement facility from central position



**Series  
NCF 30xx.V**

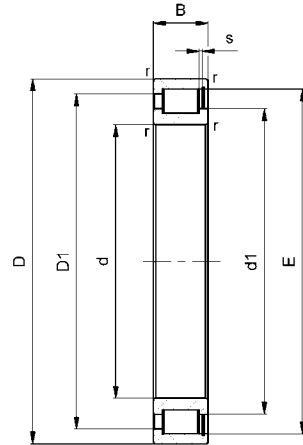

description	weight [kg]	measures [mm]								load ratings		fatigue limit load	limiting speed
		d	D	B	r min.	E	d <sub>i</sub> ca.	D <sub>1</sub> ca.	s <sup>1)</sup>	dyn. C <sub>r</sub> [kN]	stat. C <sub>or</sub> [kN]	C <sub>ur</sub> [kN]	n <sub>s</sub> [min <sup>-1</sup> ]
NCF3004V	0,11	20	42	16	0,6	37,9	27,5	35,2	1,5	28	28	3,6	10000
NCF3005V	0,12	25	47	16	0,6	42,0	31,6	39,3	1,5	31	33	4,3	9000
NCF3006V	0,2	30	55	19	1	49,7	38,5	46,8	2	40	45	5,8	7500
NCF3007V	0,26	35	62	20	1	55,6	43,6	52,5	2	49	57	7,4	6700
NCF3008V	0,31	40	68	21	1	61,8	49,0	58,5	2	58	70	9	6000
NCF3009V	0,4	45	75	23	1	68,4	54,8	65,0	2	72	92	11,8	5300
NCF3010V	0,43	50	80	23	1	73,8	60,2	70,4	2	76	102	12,4	5000
NCF3011V	0,64	55	90	26	1,1	83,6	67,6	79,6	2	98	131	17,3	4300
NCF3012V	0,69	60	95	26	1,1	86,8	70,8	82,8	2	101	138	18,4	4000
NCF3013V	0,73	65	100	26	1,1	93,2	77,2	89,1	2	107	151	20,1	3800
NCF3014V	1,02	70	110	30	1,1	102,0	82,5	97,1	3	133	179	24,5	3600
NCF3015V	1,06	75	115	30	1,1	105,9	86,4	101,0	3	137	188	26	3200
NCF3016V	1,43	80	125	34	1,1	117,1	94,6	111,4	4	168	230	30	3000
NCF3017V	1,51	85	130	34	1,1	121,5	99,1	115,9	4	173	242	31	3000
NCF3018V	1,97	90	140	37	1,5	130,2	106,2	124,5	4	202	287	36,5	2800
NCF3020V	2,15	100	150	37	1,5	139,7	115,7	134,0	4	212	314	38,5	2600
NCF3022V	3,5	110	170	45	2	156,2	127,0	149,0	5,5	280	407	49,5	2200
NCF3024V	3,8	120	180	46	2	167,7	138,5	160,5	5,5	294	446	53,5	2000
NCF3026V	5,8	130	200	52	2	184,0	148,5	175,5	5,5	418	624	74	1900
NCF3028V	6,1	140	210	53	2	197,9	162,5	189,5	5,5	441	686	80	1800
NCF3030V	7,5	150	225	56	2,1	206,9	170,0	198,0	7	463	717	83	1600
NCF3032V	9,1	160	240	60	2,1	224,9	184,5	215,0	7	530	628	94	1500
NCF3034V	12,5	170	260	67	2,1	243,0	198,0	232,0	7	681	1080	122	1400
NCF3036V	16,5	180	280	74	2,1	260,3	212,0	248,5	7	788	1270	139	1300
NCF3038V	17	190	290	75	2,1	269,9	221,5	258,0	9	809	1330	146	1300
NCF3040V	22,5	200	310	82	2,1	287,9	236,5	275,0	9	925	1540	167	1200
NCF3044V	29,5	220	340	90	3	312,4	254,5	298,0	9	1110	1840	196	1100
NCF3048V	32	240	360	92	3	335,3	277,5	321,0	11	1170	2010	210	1000
NCF3052V	46,5	260	400	104	4	376,2	304,0	358,5	11	1590	2640	265	900
NCF3056V	50	280	420	106	4	390,5	318,0	372,5	11	1630	2770	275	850
NCF3060V	69	300	460	118	4	431,8	354,5	412,5	14	2000	3560	315	750
NCF3064V	74,5	320	480	121	4	447,1	370,2	428,0	14	2050	3720	325	700
NCF3068V	100	340	520	133	5	481,6	401,5	461,5	14	2410	4570	370	670
NCF3072V	105	360	540	134	5	503,0	416,0	481,5	14	2550	4720	395	630
NCF3076V	110	380	560	135	5	520,0	433,5	498,5	14	2620	4930	410	600
NCF3080V	145	400	600	148	5	559,0	462,5	535,0	14	2980	5520	465	560
NCF3084V	150	420	620	150	5	578,0	481,5	554,0	15	3050	5760	460	530
NCF3088V	175	440	650	157	6	616,5	513,0	591,0	16	3400	6480	495	500
NCF3092V	195	460	680	163	6	633,5	524,0	606,0	16	3680	6910	540	480
NCF3096V	205	480	700	165	6	655,0	546,0	628,0	16	3770	7210	550	450
NCF30/500V	215	500	720	167	6	676,5	567,0	650,0	16	3850	7510	580	450

<sup>1)</sup> axial displacement facility from central position

# idc

## Series NJG 23xx.VH

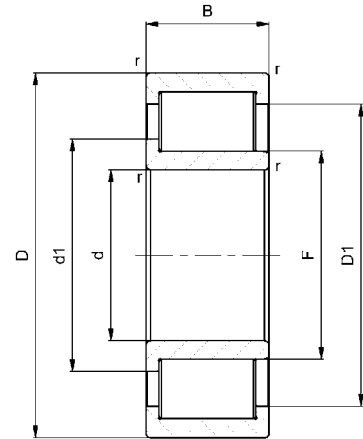

description	weight [kg]	measures [mm]								load ratings		fatigue limit load	limiting speed
		d	D	B	r min.	F	d <sub>1</sub> ca.	D <sub>1</sub> ca.	s <sup>1)</sup>	dyn. C <sub>r</sub> [kN]	stat. C <sub>or</sub> [kN]	C <sub>ur</sub> [kN]	n <sub>s</sub> [min <sup>-1</sup> ]
NJG2305VH	0,38	25	62	24	1,1	31,7	36,5	49,0	1,7	66	65	8,4	5600
NJG2306VH	0,56	30	72	27	1,1	38,3	43,5	57,0	1,8	85	88	11,7	4800
NJG2307VH	0,75	35	80	31	1,5	44,7	51,0	66,5	2	119	127	16,8	4300
NJG2308VH	1	40	90	33	1,5	51,1	58,0	76,0	2,4	146	158	21,6	3600
NJG2309VH	1,4	45	100	36	1,5	56,1	63,0	81,0	2,4	172	196	27	3400
NJG2310VH	1,8	50	110	40	2	60,7	69,0	90,5	2,6	200	220	31	3000
NJG2311VH	2,3	55	120	43	2	67,0	76,0	100,0	2,6	234	260	36	2800
NJG2312VH	2,9	60	130	46	2,1	73,6	83,0	106,5	3	263	306	46	2600
NJG2313VH	3,6	65	140	48	2,1	80,6	90,5	117,0	3	304	357	50,5	2400
NJG2314VH	4,4	70	150	51	2,1	84,1	94,5	122,0	3	334	396	54,5	2200
NJG2315VH	5,3	75	160	55	2,1	91,1	102,5	132,0	3	396	479	65,5	2000
NJG2316VH	6,4	80	170	58	2,1	98,2	110,0	142,5	4	460	564	76,5	1900
NJG2317VH	7,4	85	180	60	3	106,9	119,0	151,5	4	487	615	82	1800
NJG2318VH	8,8	90	190	64	3	108,7	122,0	158,0	4	551	684	92	1700
NJG2319VH	10,2	95	200	67	3	112,2	125,5	163,0	4	608	767	112	1600
NJG2320VH	13	100	215	73	3	119,2	133,5	173,0	4	679	864	113	1500
NJG2322VH	17,5	110	240	80	3	133,2	149,5	193,5	5	839	1080	128	1300
NJG2324VH	22,5	120	260	86	3	147,3	164,5	214,5	5	970	1260	155	1200
NJG2326VH	28	130	280	93	4	157,8	176,5	229,5	6	1100	1440	159	1200
NJG2328VH	35,5	140	300	102	4	168,3	188,0	245,0	6,5	1250	1660	178	1100
NJG2330VH	42,5	150	320	108	4	182,4	204,0	265,0	6,5	1510	2040	203	1000
NJG2332VH	49	160	340	114	4	196,4	219,5	285,5	7	1700	2340	227	950
NJG2334VH	59,5	170	360	120	4	203,4	227,5	296,0	7	1790	2460	240	900
NJG2336VH	69,5	180	380	126	4	217,5	243,0	316,5	8	1980	2720	265	800
NJG2338VH	80	190	400	132	5	224,5	250,5	326,5	8	2130	2960	275	800
NJG2340VH	92	200	420	138	5	238,5	266,5	347,0	9	2360	3290	295	750
NJG2344VH	111	220	460	145	5	267,5	296,5	379,0	10	2680	3880	335	670
NJG2348VH	147	240	500	155	5	290,4	321,5	411,5	10	3030	4410	370	630
NJG2352VH	177	260	540	165	6	313,3	347,0	444,0	11	3380	4930	410	530

<sup>1)</sup> axial displacement facility from central position

# idc

**Series  
NNC 48xx.V**

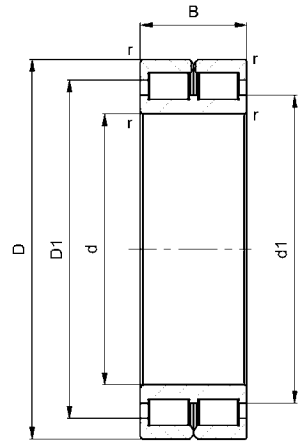

description	weight [kg]	measures [mm]						load ratings		fatigue limit load $C_{ur}$ [kN]	limiting speed $n_G$ [min <sup>-1</sup> ]
		d	D	B	r min.	d <sub>1</sub> ca.	D <sub>1</sub> ca.	dyn. C <sub>r</sub> [kN]	stat. C <sub>or</sub> [kN]		
NNC4830V	2,9	150	190	40	1,1	164,0	175,0	234	575	58	1910
NNC4832V	3,1	160	200	40	1,1	175,5	186,5	243	616	61	1800
NNC4834V	4,1	170	215	45	1,1	185,5	197,5	265	651	64	1680
NNC4836V	4,3	180	225	45	1,1	195,0	207,5	272	685	67	1600
NNC4838V	5,7	190	240	50	1,5	207,5	221,0	314	784	77	1510
NNC4840V	5,9	200	250	50	1,5	218,0	231,5	322	825	80	1440
NNC4844V	6,4	220	270	50	1,5	239,0	252,5	338	906	85	1320
NNC4848V	10	240	300	60	2	259,5	276,5	506	1310	124	1200
NNC4852V	11	260	320	60	2	282,0	299,0	529	1430	132	1120
NNC4856V	16	280	350	69	2	307,0	326,5	691	1890	173	1030
NNC4860V	23	300	380	80	2,1	328,0	350,0	810	2170	196	950
NNC4864V	24	320	400	80	2,1	351,0	373,0	840	2330	207	900
NNC4868V	25,5	340	420	80	2,1	368,0	390,0	861	2450	215	850
NNC4872V	27	360	440	80	2,1	391,0	413,0	889	2600	225	810
NNC4876V	46	380	480	100	2,1	419,0	447,0	1300	3660	315	750
NNC4880V	48	400	500	100	2,1	433,5	461,5	1330	3790	325	720
NNC4884V	50	420	520	100	2,1	455,5	483,5	1360	3990	315	690
NNC4888V	52	440	540	100	2,1	477,5	506,0	1400	4180	320	660
NNC4892V	76	460	580	118	3	503,0	534,0	1570	4680	330	630
NNC4896V	79	480	600	118	3	527,0	558,0	1610	4900	350	600
NNC48/500V	82	500	620	118	3	543,0	574,0	1640	5060	380	580
NNC48/530V	86	530	650	118	3	575,0	606,0	1690	5360	390	550



# idc

## Series NNC 49xx.V

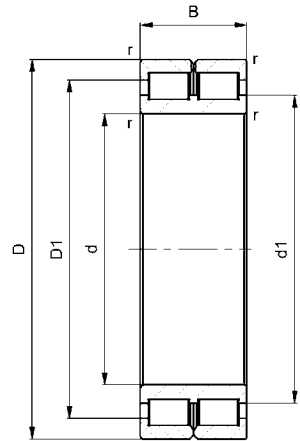

description	weight [kg]	measures [mm]						load ratings		fatigue limit load $C_{ur}$ [kN]	limiting speed $n_G$ [min <sup>-1</sup> ]
		d	D	B	r min.	d <sub>1</sub> ca.	D <sub>1</sub> ca.	dyn. C <sub>r</sub> [kN]	stat. C <sub>or</sub> [kN]		
NNC4912V	0,49	60	85	25	1	69,8	75,9	75	133	15,7	4450
NNC4914V	0,78	70	100	30	1	81,0	89,0	107	198	23,5	3800
NNC4916V	0,88	80	110	30	1	89,9	97,9	113	220	26	3400
NNC4918V	1,4	90	125	35	1,1	102,6	112,0	152	307	36	3000
NNC4920V	2	100	140	40	1,1	115,3	126,5	194	400	45	2700
NNC4922V	2,2	110	150	40	1,1	124,0	135,0	202	431	47	2490
NNC4924V	3	120	165	45	1,1	137,5	150,0	226	479	52	2270
NNC4926V	4	130	180	50	1,5	147,5	161,5	262	554	60	2090
NNC4928V	4,2	140	190	50	1,5	158,0	172,0	272	595	63	1960
NNC4930V	6,7	150	210	60	2	170,5	186,5	389	858	87	1800
NNC4932V	7	160	220	60	2	183,0	199,0	404	922	92	1710
NNC4934V	7,4	170	230	60	2	191,0	207,0	414	965	95	1620
NNC4936V	10,8	180	250	69	2	204,5	224,5	557	1240	126	1510
NNC4938V	11,2	190	260	69	2	215,0	234,5	572	1310	132	1440
NNC4940V	15,8	200	280	80	2,1	230,5	252,5	671	1510	153	1350
NNC4944V	17,2	220	300	80	2,1	247,5	269,5	697	1630	160	1250
NNC4948V	18,5	240	320	80	2,1	270,5	292,5	731	1780	171	1160
NNC4952V	32	260	360	100	2,1	294,5	322,5	1080	2540	243	1050
NNC4956V	34	280	380	100	2,1	316,5	344,5	1120	2740	255	980
NNC4960V	53	300	420	118	3	343,5	378,5	1560	3660	350	900
NNC4964V	56	320	440	118	3	362,0	397,0	1610	3860	365	850
NNC4968V	59	340	460	118	3	380,5	415,5	1650	4070	380	810
NNC4972V	62	360	480	118	3	399,0	434,0	1700	4270	395	770
NNC4976V	92,5	380	520	140	4	430,0	469,0	2210	5750	505	720
NNC4980V	96,5	400	540	140	4	450,5	489,0	2270	6030	525	690
NNC4984V	99,5	420	560	140	4	471,0	510,0	2330	6310	550	660
NNC4988V	137	440	600	160	4	499,5	548,0	2980	7540	565	630
NNC4992V	140	460	620	160	4	512,0	561,0	3020	7740	575	600
NNC4996V	165	480	650	170	5	537,0	589,0	3310	8560	710	570
NNC49/500V	175	500	670	170	5	564,0	615,0	3400	9000	745	550
NNC49/530V	200	530	710	180	5	589,0	645,0	3820	9910	810	520



**Series  
NNCF 48xx.V**

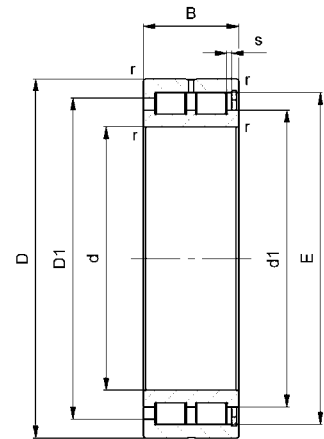

description	weight [kg]	measures [mm]								load ratings		fatigue limit load	limiting speed
		d	D	B	r min.	E	d <sub>1</sub> ca.	D <sub>1</sub> ca.	s <sup>1)</sup>	dyn. C <sub>r</sub> [kN]	stat. C <sub>or</sub> [kN]	C <sub>ur</sub> [kN]	n <sub>s</sub> [min <sup>-1</sup> ]
NNCF4830V	2,9	150	190	40	1,1	178,5	164,0	175,0	2	234	575	58	1910
NNCF4832V	3,1	160	200	40	1,1	190,0	175,5	186,5	2	243	616	61	1800
NNCF4834V	4,1	170	215	45	1,1	201,6	185,5	197,5	3	265	651	64	1680
NNCF4836V	4,3	180	225	45	1,1	211,1	195,0	207,5	3	272	685	67	1600
NNCF4838V	5,7	190	240	50	1,5	225,2	207,5	221,0	4	314	784	77	1510
NNCF4840V	5,9	200	250	50	1,5	235,7	218,0	231,5	4	322	825	80	1440
NNCF4844V	6,4	220	270	50	1,5	256,8	239,0	252,5	4	338	906	85	1320
NNCF4848V	10	240	300	60	2	282,1	259,5	276,5	4	506	1310	124	1200
NNCF4852V	11	260	320	60	2	304,5	282,0	299,0	4	529	1430	132	1120
NNCF4856V	16	280	350	69	2	332,6	307,0	326,5	4	691	1890	173	1030
NNCF4860V	23	300	380	80	2,1	357,0	328,0	350,0	6	810	2170	196	950
NNCF4864V	24	320	400	80	2,1	379,9	351,0	373,0	6	840	2330	207	900
NNCF4868V	25,5	340	420	80	2,1	397,2	368,0	390,0	6	861	2450	215	850
NNCF4872V	27	360	440	80	2,1	420,1	391,0	413,0	6	889	2600	225	810
NNCF4876V	46	380	480	100	2,1	456,1	419,0	447,0	6	1300	3660	315	750
NNCF4880V	48	400	500	100	2,1	470,8	433,5	461,5	6	1330	3790	325	720
NNCF4884V	50	420	520	100	2,1	492,8	455,5	483,5	6	1360	3990	315	690
NNCF4888V	52	440	540	100	2,1	515,0	477,5	506,0	6	1400	4180	320	660
NNCF4892V	76	460	580	118	3	543,5	503,0	534,0	7	1570	4680	330	630
NNCF4896V	79	480	600	118	3	567,5	527,0	558,0	7	1610	4900	350	600
NNCF48/500V	82	500	620	118	3	583,5	543,0	574,0	7	1640	5060	380	580
NNCF48/530V	86	530	650	118	3	615,5	575,0	606,0	7	1690	5360	390	550

<sup>1)</sup> axial displacement facility from central position



**Series  
NNCF 49xx.V**

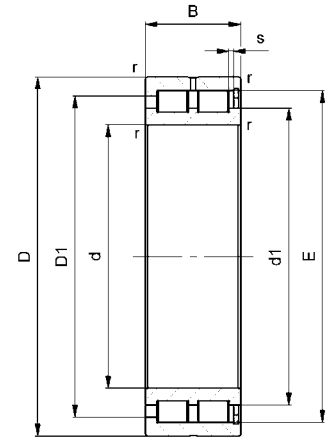

description	weight [kg]	measures [mm]								load ratings		fatigue limit load	limiting speed
		d	D	B	r min.	E	d <sub>1</sub> ca.	D <sub>1</sub> ca.	s <sup>1)</sup>	dyn. C <sub>r</sub> [kN]	stat. C <sub>or</sub> [kN]	C <sub>ur</sub> [kN]	n <sub>s</sub> [min <sup>-1</sup> ]
NNCF4912V	0,49	60	85	25	1	78,9	69,8	75,9	1	75	133	15,7	4450
NNCF4914V	0,78	70	100	30	1	92,0	81,0	89,0	1	107	198	23,5	3800
NNCF4916V	0,88	80	110	30	1	100,9	89,9	97,9	1	113	220	26	3400
NNCF4918V	1,4	90	125	35	1,1	115,3	102,6	112,0	1,5	152	307	36	3000
NNCF4920V	2	100	140	40	1,1	129,7	115,3	126,5	2	194	400	45	2700
NNCF4922V	2,2	110	150	40	1,1	138,3	124,0	135,0	2	202	431	47	2490
NNCF4924V	3	120	165	45	1,1	153,7	137,5	150,0	3	226	479	52	2270
NNCF4926V	4	130	180	50	1,5	165,6	147,5	161,5	4	262	554	60	2090
NNCF4928V	4,2	140	190	50	1,5	176,1	158,0	172,0	4	272	595	63	1960
NNCF4930V	6,7	150	210	60	2	191,5	170,5	186,5	4	389	858	87	1800
NNCF4932V	7	160	220	60	2	203,9	183,0	199,0	4	404	922	92	1710
NNCF4934V	7,4	170	230	60	2	212,2	191,0	207,0	4	414	965	95	1620
NNCF4936V	10,8	180	250	69	2	230,6	204,5	224,5	4	557	1240	126	1510
NNCF4938V	11,2	190	260	69	2	240,8	215,0	234,5	4	572	1310	132	1440
NNCF4940V	15,8	200	280	80	2,1	259,4	230,5	252,5	5	671	1510	153	1350
NNCF4944V	17,2	220	300	80	2,1	276,6	247,5	269,5	5	697	1630	160	1250
NNCF4948V	18,5	240	320	80	2,1	299,6	270,5	292,5	5	731	1780	171	1160
NNCF4952V	32	260	360	100	2,1	331,5	294,5	322,5	6	1080	2540	243	1050
NNCF4956V	34	280	380	100	2,1	353,4	316,5	344,5	6	1120	2740	255	980
NNCF4960V	53	300	420	118	3	390,2	343,5	378,5	6	1560	3660	350	900
NNCF4964V	56	320	440	118	3	408,7	362,0	397,0	6	1610	3860	365	850
NNCF4968V	59	340	460	118	3	427,1	380,5	415,5	6	1650	4070	380	810
NNCF4972V	62	360	480	118	3	445,6	399,0	434,0	6	1700	4270	395	770
NNCF4976V	92,5	380	520	140	4	481,5	430,0	469,0	7	2210	5750	505	720
NNCF4980V	96,5	400	540	140	4	502,0	450,5	489,0	7	2270	6030	525	690
NNCF4984V	99,5	420	560	140	4	522,5	471,0	510,0	7	2330	6310	550	660
NNCF4988V	137	440	600	160	4	564,0	499,5	548,0	7	2980	7540	565	630
NNCF4992V	140	460	620	160	4	576,5	512,0	561,0	7	3020	7740	575	600
NNCF4996V	165	480	650	170	5	605,5	537,0	589,0	8	3310	8560	710	570
NNCF49/500V	175	500	670	170	5	632,0	564,0	615,0	8	3400	9000	745	550
NNCF49/530V	200	530	710	180	5	663,0	589,0	645,0	8	3820	9910	810	520

<sup>1)</sup> axial displacement facility from central position



**Series  
NNCF 50xx.V**

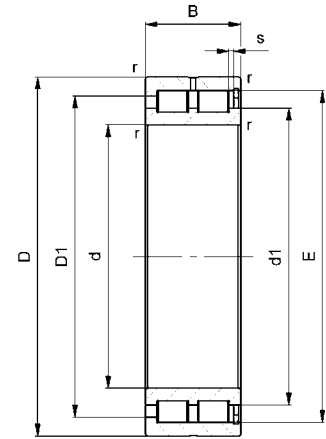

description	weight [kg]	measures [mm]								load ratings		fatigue limit load	limiting speed
		d	D	B	r min.	E	d <sub>1</sub> ca.	D <sub>1</sub> ca.	s <sup>1)</sup>	dyn. C <sub>r</sub> [kN]	stat. C <sub>0r</sub> [kN]	C <sub>0r</sub> [kN]	n <sub>G</sub> [min <sup>-1</sup> ]
NNCF5004V	0,2	20	42	30	0,6	37,9	27,5	35,3	4,5	49	56	6,8	10000
NNCF5005V	0,23	25	47	30	0,6	42,0	31,6	39,3	4,5	54	65	8,2	9000
NNCF5006V	0,35	30	55	34	1	49,7	38,5	46,8	4,5	69	90	11	7500
NNCF5007V	0,46	35	62	36	1	55,6	43,6	52,5	4,5	84	114	14	6700
NNCF5008V	0,56	40	68	38	1	61,8	49,0	58,5	4,5	98	138	17	6000
NNCF5009V	0,71	45	75	40	1	68,4	54,8	65,0	4,5	123	184	22,5	5300
NNCF5010V	0,76	50	80	40	1	73,8	60,2	70,4	4,5	130	203	23,6	5000
NNCF5011V	1,16	55	90	46	1,1	83,6	67,6	79,6	4,5	169	262	33,5	4300
NNCF5012V	1,24	60	95	46	1,1	86,8	70,8	82,8	4,5	174	276	35	4000
NNCF5013V	1,32	65	100	46	1,1	93,2	77,2	89,1	4,5	183	302	38,5	3800
NNCF5014V	1,85	70	110	54	1,1	100,4	81,1	95,5	5	226	357	46,5	3600
NNCF5015V	1,93	75	115	54	1,1	108,0	88,8	103,2	5	239	393	51	3200
NNCF5016V	2,59	80	125	60	1,1	117,1	94,6	111,4	5	289	460	57,5	3000
NNCF5017V	2,72	85	130	60	1,1	121,5	99,1	115,9	5	297	484	59,5	3000
NNCF5018V	3,62	90	140	67	1,5	130,2	106,2	124,5	5	346	573	69,5	2800
NNCF5020V	3,94	100	150	67	1,5	139,7	115,7	134,0	6	364	628	74	2600
NNCF5022V	6,32	110	170	80	2	156,2	127,0	149,0	6	479	814	95	2200
NNCF5024V	6,77	120	180	80	2	167,7	138,5	160,5	6	505	891	102	2000
NNCF5026V	10,2	130	200	95	2	184,0	148,5	175,5	7	717	1250	153	1900
NNCF5028V	11,1	140	210	95	2	197,9	162,5	189,5	7	756	1370	154	1800
NNCF5030V	13,3	150	225	100	2	206,9	170,0	198,0	7	793	1430	160	1700
NNCF5032V	16,2	160	240	109	2,1	224,9	184,5	215,0	7	909	1660	172	1500
NNCF5034V	23	170	260	122	2,1	243,0	198,0	232,0	7	1170	2160	224	1400
NNCF5036V	30,5	180	280	136	2,1	260,4	212,0	248,5	8	1350	2540	255	1300
NNCF5038V	31,5	190	290	136	2,1	269,9	221,5	258,0	8	1390	2660	265	1300
NNCF5040V	41	200	310	150	2,1	287,9	236,5	275,0	8	1590	3080	300	1200
NNCF5044V	52,5	220	340	160	3	312,4	254,5	298,0	8	1900	3680	355	1100
NNCF5048V	56	240	360	160	3	335,3	277,5	321,0	9,4	2000	4030	380	1000
NNCF5052V	85,5	260	400	190	4	376,2	304,0	358,5	9,4	2720	5270	475	900
NNCF5056V	90,5	280	420	190	4	390,5	318,0	372,5	9,4	2800	5540	500	850
NNCF5060V	130	300	460	218	4	431,8	354,5	412,5	9,4	3430	7110	630	750
NNCF5064V	135	320	480	218	4	447,1	370,0	428,0	9,4	3510	7440	590	700
NNCF5068V	185	340	520	243	5	481,6	401,5	461,5	9,4	4140	9140	670	670
NNCF5072V	195	360	540	243	5	503,0	416,0	481,5	9,4	4390	9460	725	630
NNCF5076V	200	380	560	243	5	520,0	433,5	498,5	9,4	4490	9870	730	600
NNCF5080V	270	400	600	272	5	559,0	462,5	535,0	9,4	5320	11640	870	560

<sup>1)</sup> axial displacement facility from central position





**Series  
NNCL 48xx.V**

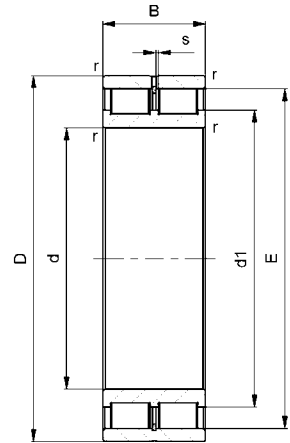

description	weight [kg]	measures [mm]							load ratings		fatigue limit load	limiting speed
		d	D	B	r min.	E	d <sub>1</sub> ca.	s <sup>1)</sup>	dyn. C <sub>r</sub> [kN]	stat. C <sub>0r</sub> [kN]	C <sub>0r</sub> [kN]	n <sub>G</sub> [min <sup>-1</sup> ]
NNCL4830V	2,9	150	190	40	1,1	178,5	164,0	2	234	575	58	1910
NNCL4832V	3,1	160	200	40	1,1	190,0	175,5	2	243	616	61	1800
NNCL4834V	4,1	170	215	45	1,1	201,6	185,5	3	265	651	64	1680
NNCL4836V	4,3	180	225	45	1,1	211,1	195,0	3	272	685	67	1600
NNCL4838V	5,7	190	240	50	1,5	225,2	207,5	4	314	784	77	1510
NNCL4840V	5,9	200	250	50	1,5	235,7	218,0	4	322	825	80	1440
NNCL4844V	6,4	220	270	50	1,5	256,8	239,0	4	338	906	85	1320
NNCL4848V	10	240	300	60	2	282,1	259,5	4	506	1310	124	1200
NNCL4852V	11	260	320	60	2	304,5	282,0	4	529	1430	132	1120
NNCL4856V	16	280	350	69	2	332,6	307,0	4	691	1890	173	1030
NNCL4860V	23	300	380	80	2,1	357,0	328,0	6	810	2170	196	950
NNCL4864V	24	320	400	80	2,1	379,9	351,0	6	840	2330	207	900
NNCL4868V	25,5	340	420	80	2,1	397,2	368,0	6	861	2450	215	850
NNCL4872V	27	360	440	80	2,1	420,1	391,0	6	889	2600	225	810
NNCL4876V	46	380	480	100	2,1	456,1	419,0	6	1300	3660	315	750
NNCL4880V	48	400	500	100	2,1	470,8	433,5	6	1330	3790	325	720
NNCL4884V	50	420	520	100	2,1	492,8	455,5	6	1360	3990	315	690
NNCL4888V	52	440	540	100	2,1	515,0	477,5	6	1400	4180	320	660
NNCL4892V	76	460	580	118	3	543,5	503,0	7	1570	4680	330	630
NNCL4896V	79	480	600	118	3	567,5	527,0	7	1610	4900	350	600
NNCL48/500V	82	500	620	118	3	583,5	543,0	7	1640	5060	380	580
NNCL48/530V	86	530	650	118	3	615,5	575,0	7	1690	5360	390	550

<sup>1)</sup> axial displacement facility from central position



**Series  
NNCL 49xx.V**

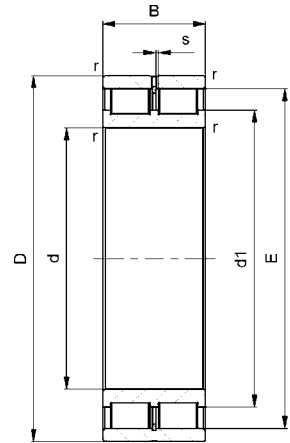

description	weight [kg]	measures [mm]							load ratings		fatigue limit load	limiting speed
		d	D	B	r min.	E	d <sub>1</sub> ca.	s <sup>1)</sup>	dyn. C <sub>r</sub> [kN]	stat. C <sub>0r</sub> [kN]	C <sub>0r</sub> [kN]	n <sub>G</sub> [min <sup>-1</sup> ]
NNCL4912V	0,49	60	85	25	1	78,9	69,8	1	75	133	15,7	4450
NNCL4914V	0,78	70	100	30	1	92,0	81,0	1	107	198	23,5	3800
NNCL4916V	0,88	80	110	30	1	100,9	89,9	1	113	220	26	3400
NNCL4918V	1,4	90	125	35	1,1	115,3	102,6	1,5	152	307	36	3000
NNCL4920V	2	100	140	40	1,1	129,7	115,3	2	194	400	45	2700
NNCL4922V	2,2	110	150	40	1,1	138,3	124,0	2	202	431	47	2490
NNCL4924V	3	120	165	45	1,1	153,7	137,5	3	226	479	52	2270
NNCL4926V	4	130	180	50	1,5	165,6	147,5	4	262	554	60	2090
NNCL4928V	4,2	140	190	50	1,5	176,1	158,0	4	272	595	63	1960
NNCL4930V	6,7	150	210	60	2	191,5	170,5	4	389	858	87	1800
NNCL4932V	7	160	220	60	2	203,9	183,0	4	404	922	92	1710
NNCL4934V	7,4	170	230	60	2	212,2	191,0	4	414	965	95	1620
NNCL4936V	10,8	180	250	69	2	230,6	204,5	4	557	1240	126	1510
NNCL4938V	11,2	190	260	69	2	240,8	215,0	4	572	1310	132	1440
NNCL4940V	15,8	200	280	80	2,1	259,4	230,5	5	671	1510	153	1350
NNCL4944V	17,2	220	300	80	2,1	276,6	247,5	5	697	1630	160	1250
NNCL4948V	18,5	240	320	80	2,1	299,6	270,5	5	731	1780	171	1160
NNCL4952V	32	260	360	100	2,1	331,5	294,5	6	1080	2540	243	1050
NNCL4956V	34	280	380	100	2,1	353,4	316,5	6	1120	2740	255	980
NNCL4960V	53	300	420	118	3	390,2	343,5	6	1560	3660	350	900
NNCL4964V	56	320	440	118	3	408,7	362,0	6	1610	3860	365	850
NNCL4968V	59	340	460	118	3	427,1	380,5	6	1650	4070	380	810
NNCL4972V	62	360	480	118	3	445,6	399,0	6	1700	4270	395	770
NNCL4976V	92,5	380	520	140	4	481,5	430,0	7	2210	5750	505	720
NNCL4980V	96,5	400	540	140	4	502,0	450,5	7	2270	6030	525	690
NNCL4984V	99,5	420	560	140	4	522,5	471,0	7	2330	6310	550	660
NNCL4988V	137	440	600	160	4	564,0	499,5	7	2980	7540	565	630
NNCL4992V	140	460	620	160	4	576,5	512,0	7	3020	7740	575	600
NNCL4996V	165	480	650	170	5	605,5	537,0	8	3310	8560	710	570
NNCL49/500V	175	500	670	170	5	632,0	564,0	8	3400	9000	745	550
NNCL49/530V	200	530	710	180	5	663,0	589,0	8	3820	9910	810	520

<sup>1)</sup> axial displacement facility from central position



**Series  
NNF 50xx-PP**

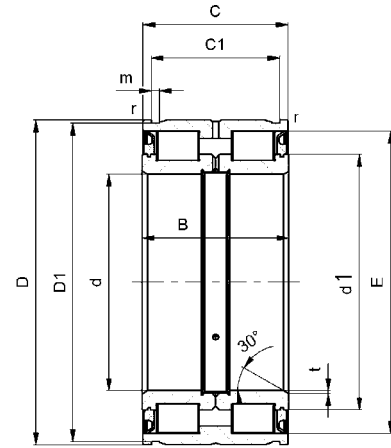

description	weight [kg]	measures [mm]											load ratings		fatigue limit load $C_{Ur}$ [kN]	limiting speed $n_G$ [min <sup>-1</sup> ]
		d	D	B	C	r min.	E	d <sub>1</sub> ca.	C <sub>1</sub> +0,2	D <sub>1</sub> +0,2	m	t	dyn. C <sub>r</sub> [kN]	stat. C <sub>0r</sub> [kN]		
NNF5004-PP	0,21	20	42	30	29	0,3	35,5	28,2	24,7	40,2	1,8	0,5	40	50	5,7	3600
NNF5005-PP	0,23	25	47	30	29	0,3	40,2	32,9	24,7	45,2	1,8	0,5	44	60	6,7	3000
NNF5006-PP	0,35	30	55	34	33	0,3	47,8	39,6	28,2	53	2,1	0,5	52	73	8,2	2600
NNF5007-PP	0,45	35	62	36	35	0,6	54,4	44,5	30,2	60	2,1	0,5	66	93	11,1	2200
NNF5008-PP	0,53	40	68	38	37	0,6	60,8	50,0	32,2	65,8	2,7	0,8	81	118	14,5	2000
NNF5009-PP	0,68	45	75	40	39	0,6	67,5	55,7	34,2	72,8	2,7	0,8	97	147	18,2	1800
NNF5010-PP	0,73	50	80	40	39	0,6	72,3	60,5	34,2	77,8	2,7	0,8	102	161	19,8	1700
NNF5011-PP	1,1	55	90	46	45	0,6	79,6	67,0	40,2	87,4	3,2	1	120	196	23,7	1500
NNF5012-PP	1,2	60	95	46	45	0,6	84,7	72,1	40,2	92,4	3,2	1	125	212	26	1400
NNF5013-PP	1,3	65	100	46	45	0,6	89,8	77,2	40,2	97,4	3,2	1	130	228	27,5	1300
NNF5014-PP	1,9	70	110	54	53	0,6	99,5	83,7	48,2	107,1	4,2	1	171	285	35	1200
NNF5015-PP	2	75	115	54	53	0,6	105,9	90,1	48,2	112,1	4,2	1	178	308	37,5	1100
NNF5016-PP	2,7	80	125	60	59	0,6	113,0	95,6	54,2	122,1	4,2	1,5	239	426	51	1000
NNF5017-PP	2,8	85	130	60	59	0,6	119,4	100,4	54,2	127,1	4,2	1,5	256	447	54	1000
NNF5018-PP	3,8	90	140	67	66	0,6	127,1	108,0	59,2	137	4,2	1,5	292	539	65	900
NNF5019-PP	4	95	145	67	66	0,6	130,9	111,9	59,2	142	4,2	1,5	297	559	66	900
NNF5020-PP	4,1	100	150	67	66	0,6	137,7	117,0	59,2	147	4,2	1,5	315	578	67	850
NNF5022-PP	6,5	110	170	80	79	0,6	154,1	130,0	70,2	167	4,2	1,8	389	711	82	750
NNF5024-PP	6,9	120	180	80	79	0,6	163,6	140,0	71,2	176	4,2	1,8	406	765	87	700
NNF5026-PP	10,5	130	200	95	94	0,6	183,0	153,0	83,2	196	4,2	1,8	582	1062	121	630
NNF5028-PP	11	140	210	95	94	0,6	195,1	165,0	83,2	206	5,2	1,8	608	1150	129	600
NNF5030-PP	13,5	150	225	100	99	0,6	209,0	175,5	87,2	221	5,2	2	697	1300	143	560
NNF5032-PP	16,5	160	240	109	108	0,6	222,4	189,0	95,2	236	5,2	2	727	1410	152	500
NNF5034-PP	22,5	170	260	122	121	0,6	238,8	200,5	107,2	254	5,2	2	934	1800	191	480
NNF5036-PP	30	180	280	136	135	0,6	258,7	217,5	118,2	274	5,2	2	1110	2180	231	450
NNF5038-PP	31,5	190	290	136	135	0,6	267,0	225,5	118,2	284	5,2	2	1130	2270	240	430
NNF5040-PP	42	200	310	150	149	0,6	283,6	242,0	128,2	304	6,3	2	1290	2740	275	400
NNF5044-PP	53,5	220	340	160	159	1	308,1	260,0	138,2	334	6,3	2	1520	3140	315	360
NNF5048-PP	57,5	240	360	160	159	1	327,2	279,5	138,2	354	6,3	2	1580	3380	335	340
NNF5052-PP	84,5	260	400	190	189	1,1	369,7	312,0	162,2	394	6,3	3	2200	4720	480	320
NNF5056-PP	90	280	420	190	189	1,1	392,6	335,0	163,2	413	7,3	3	2290	5080	510	300
NNF5060-PP	126	300	460	218	216	1,1	417,9	351,0	185,2	453	7,3	3	2880	6210	595	280

light series:

NNF130-PP	7,5	130	190	80	79	0,6	173,2	149,5	71,2	186	1,8	1,8	421	820	92	670
NNF140-PP	8	140	200	80	79	0,6	182,8	159,0	71,2	196	1,8	1,8	436	875	96	630
NNF150-PP	8,4	150	210	80	79	0,6	197,1	173,5	71,2	206	2,1	1,8	457	957	101	560
NNF160-PP	8,8	160	220	80	79	0,6	206,6	183,0	71,2	216	2,1	1,8	471	1010	106	530
NNF170-PP	9,3	170	230	80	79	0,6	216,2	192,5	71,2	226	2,7	1,8	484	1060	111	530
NNF180-PP	9,8	180	240	80	79	0,6	225,8	202,0	71,2	236	2,7	1,8	497	1120	115	500
NNF190-PP	12,7	190	260	80	79	0,6	240,1	216,5	73,2	254	2,7	1,8	516	1200	121	450
NNF200-PP	13,2	200	270	80	79	0,6	249,7	226,0	73,2	264	3,2	1,8	528	1260	125	430
NNF220-PP	19,5	220	300	95	94	1	276,6	248,0	83,2	294	3,2	2	698	1630	162	400
NNF240-PP	21	240	320	95	94	1	299,6	271,0	83,2	314	3,2	2	732	1780	170	370
NNF260-PP	22,5	260	340	95	94	1	322,3	292,0	83,2	334	4,2	3	833	1080	195	350
NNF300-PP	25,5	300	380	95	94	1	358,6	328,5	83,2	374	4,2	3	887	2350	205	320



Full complement  
cylindrical roller bearings

---

INTERPRECISE Donath GmbH  
Ostring 2  
90587 Obermichelbach  
Germany

Phone +49-911-76630-0  
Fax +49-911-76630-30

[info@interprecise.de](mailto:info@interprecise.de)  
[www.idc-bearings.com](http://www.idc-bearings.com)